

MANUAL

PGV...-F200/-F200A...-B16-V15 Incident Light Positioning System

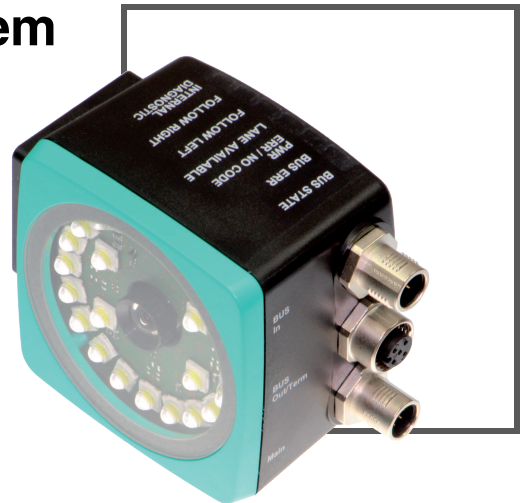

CANopen



With regard to the supply of products, the current issue of the following document is applicable: The General Terms of Delivery for Products and Services of the Electrical Industry, published by the Central Association of the Electrical Industry (Zentralverband Elektrotechnik und Elektroindustrie (ZVEI) e.V.) in its most recent version as well as the supplementary clause: "Expanded reservation of proprietorship"

1	Safety	5
1.1	Introduction	5
1.1.1	Contents	5
1.1.2	Target Group, Personnel	5
1.1.3	Symbols Used.....	5
2	Product Description	7
2.1	Use and Application.....	7
2.2	LED Indicators and Controls.....	8
2.3	Accessories	12
3	Installation.....	13
3.1	Mounting the Read Head	13
3.2	Mounting the Colored Tape and Code Tape	15
3.3	Electrical Connection	32
3.4	CANopen Connection	34
4	Commissioning.....	35
4.1	Specifying the First Direction Decision	35
4.2	Direction Decision.....	35
4.3	Parameterization of Fieldbus Address and Baud Rate.....	37
4.3.1	Product documentation on the internet	39
4.4	EDS Configuration File	39
5	Operation and communication.....	40
5.1	Data Exchange in the CANopen Bus.....	40
5.1.1	General Information about CANopen.....	40
5.1.2	Basic Technical Information about CANopen.....	41
5.1.3	CANopen Object Directory	44
5.1.4	Object 3001	62
5.2	Operation Using Control Codes	64
5.3	Operation Using Repair Tape	65

6	Appendix	67
6.1	ASCII table.....	67
6.2	Code cards with special functions	67
6.3	Code Cards for Setting the Baud Rate	69

1 Safety

1.1 Introduction

1.1.1 Contents

This document contains information that you need in order to use your product throughout the applicable stages of the product life cycle. These can include the following:

- Product identification
- Delivery, transport, and storage
- Mounting and installation
- Commissioning and operation
- Maintenance and repair
- Troubleshooting
- Dismounting
- Disposal



Note!

This document does not substitute the instruction manual.



Note!

For full information on the product, refer to the instruction manual and further documentation on the Internet at www.pepperl-fuchs.com.

The documentation consists of the following parts:

- Present document
- Instruction manual
- Datasheet

Additionally, the following parts may belong to the documentation, if applicable:

- EU-type examination certificate
- EU declaration of conformity
- Attestation of conformity
- Certificates
- Control drawings
- Additional documents

1.1.2 Target Group, Personnel

Responsibility for planning, assembly, commissioning, operation, maintenance, and dismounting lies with the plant operator.

Only appropriately trained and qualified personnel may carry out mounting, installation, commissioning, operation, maintenance, and dismounting of the product. The personnel must have read and understood the instruction manual and the further documentation.

Prior to using the product make yourself familiar with it. Read the document carefully.

1.1.3 Symbols Used

This document contains symbols for the identification of warning messages and of informative messages.



Warning Messages

You will find warning messages, whenever dangers may arise from your actions. It is mandatory that you observe these warning messages for your personal safety and in order to avoid property damage.

Depending on the risk level, the warning messages are displayed in descending order as follows:



Danger!

This symbol indicates an imminent danger.

Non-observance will result in personal injury or death.



Warning!

This symbol indicates a possible fault or danger.

Non-observance may cause personal injury or serious property damage.



Caution!

This symbol indicates a possible fault.

Non-observance could interrupt the device and any connected systems and plants, or result in their complete failure.

Informative Symbols



Note!

This symbol brings important information to your attention.



Action

This symbol indicates a paragraph with instructions. You are prompted to perform an action or a sequence of actions.

2 Product Description

2.1 Use and Application

Intended Use

This device, when used together with a colored tape affixed to the floor and code tapes printed with Data Matrix codes, constitute a high-resolution lane tracking and positioning system. It can be used in all applications where automated guided vehicles (AGV) are to be positioned precisely at marked positions along a given lane.

The read head forms part of the positioning system in the Pepperl+Fuchs incident light process. The read head's features include a camera module and an integrated illumination unit. The read head uses these features to detect a colored tape stuck to the floor or a painted color lane to track the lane. The read head detects Data Matrix tags to navigate within a grid. The read head also detects control codes and position markers in the form of Data Matrix codes printed on a self-adhesive code tape. Data Matrix code tapes and Data Matrix tags have priority over colored tapes or colored lanes.

The Data Matrix code tapes are installed in a fixed position instead of or along with the colored tape. The read head is located on an automated guided vehicle (AGV) and guides this vehicle along the colored tape.



Note!

Priority

Data Matrix code tapes and Data Matrix tags have priority over colored tapes or colored lanes. If the read head detects a Data Matrix code tape or Data Matrix tags in the field of view, colored tapes or colored lanes in the field of view are ignored.

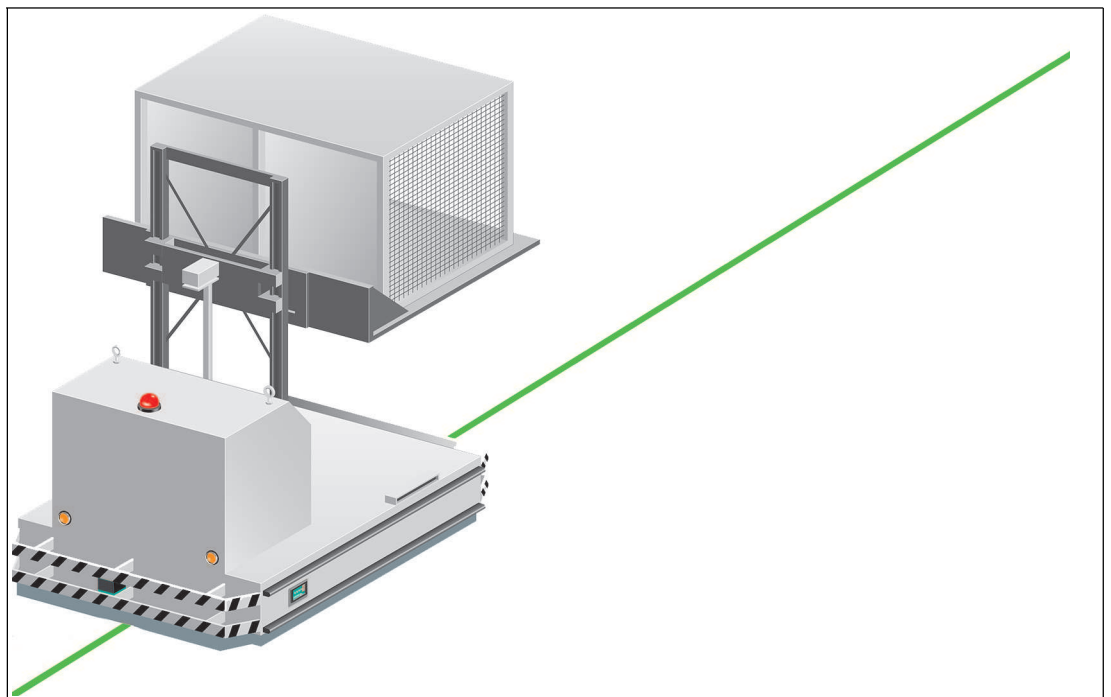

Figure 2.1 Automated guided vehicle with green colored tape

Tag Mode

In addition to the tracking, you can use the read head in tag mode. The read head detects Data Matrix tags, which are typically glued onto the floor in a grid. The individual Data Matrix tags are numbered consecutively and include position information. The read head reports the position of the AGV in relation to the zero point of the Data Matrix tag to the controller.

The tag mode allows the AGV to move freely in as large a grid as desired, without having to mark the crossing paths with lane tapes.

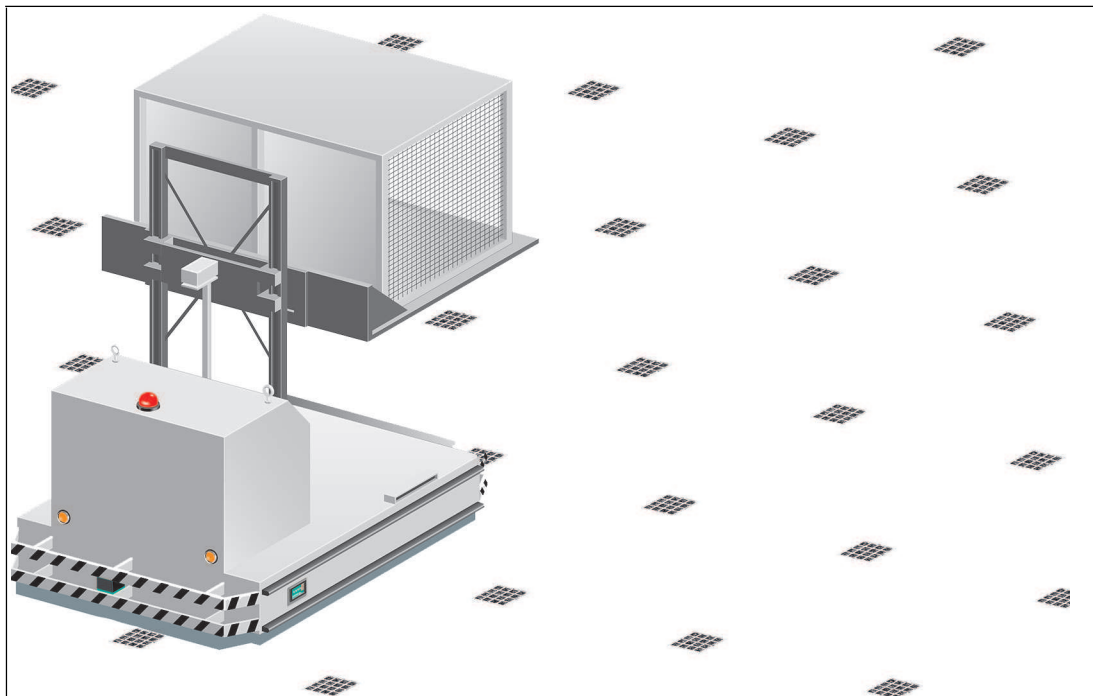

Figure 2.2 Automated guided vehicle with Data Matrix tags

The read head switches automatically between tag mode and lane tracking. This allows an automated guided vehicle to be guided from one Data Matrix tag grid via a colored or Data Matrix lane to another Data Matrix tag grid.

The extensive yet user-friendly parameterization options as well as the configurable inputs and outputs mean that the read head can easily be adapted to suit each application.

2.2

LED Indicators and Controls

The PGV... reader is equipped with seven indicator LEDs for carrying out visual function checks and rapid diagnostics. The reader is equipped with two buttons at the back for activating parameterization mode. Button 1 is labeled ADJUST. Button 2 is labeled CONFIG.

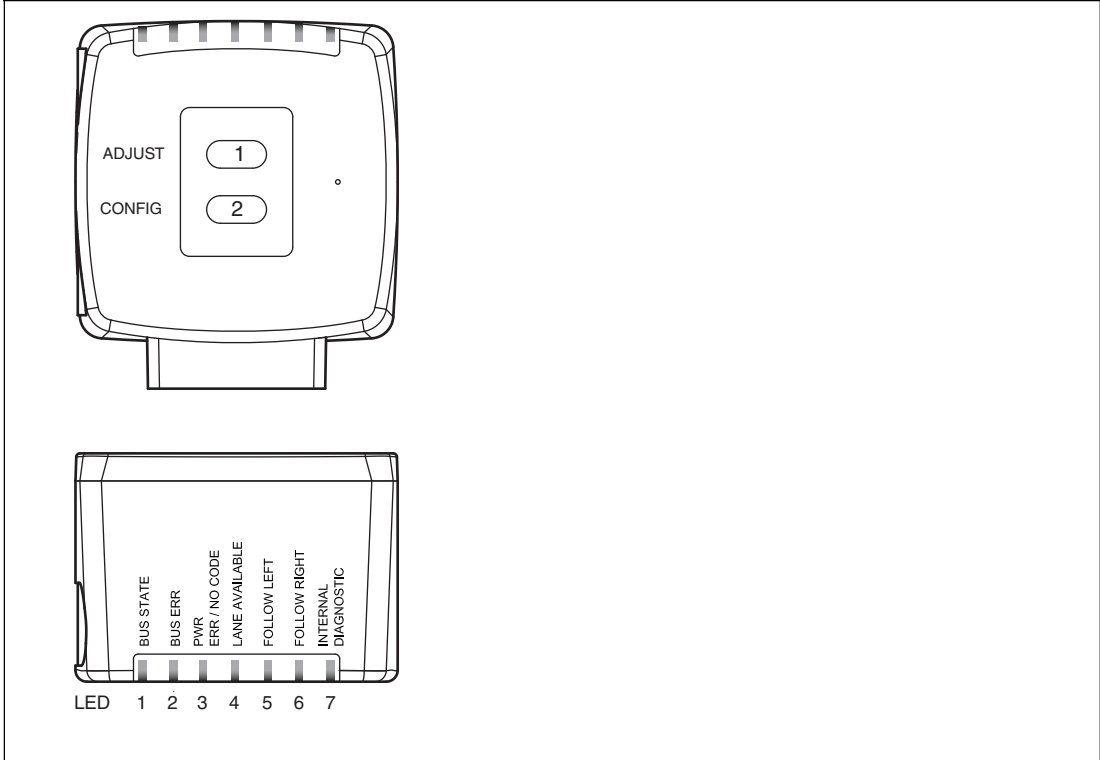

Figure 2.3

LED	[#1] BUS STATE	[#2] BUSERR	[#3] PWR ERR/NO CODE	[#4] LANE AVAILABLE	[#5] FOLLOW LEFT	[#6] FOLLOW RIGHT	[#7] INTERNAL DIAGNOSTIC	Description
Color	Yellow	Red	Green/ red	Yellow	Yellow	Yellow	Red/ green/ yellow	
Status	x	x	Flashes red	x	x	x	x	Code tape outside read range $f_{\text{flash}} = 2 \text{ Hz}$
	x	x	Lights up red	x	x	x	x	System error ¹
	x	x	Lights up green	x	x	x	x	Code tape detected, absolute position available
	x	x	x	Lights up	x	x	x	Colored tape detected
	x	x	x	Off	x	x	x	Colored tape outside read range
	x	x	x	x	Off	Off	x	No direction selection activated
	x	x	x	x	Lights up	Off	x	"Follow left-hand lane" activated
	x	x	x	x	Off	Lights up	x	"Follow right-hand lane" activated
	x	x	x	x	Lights up	Lights up	x	"Straight ahead" activated
	Lights up	x	x	x	x	x	x	CANopen data transfer
	x	Flashes	x	x	x	x	x	CANopen error $f_{\text{flash}} = 1 \text{ Hz}$
	x	x	Flashes red	Flashes	Flashes	Flashes	Off	Normal operation. Indication for 2 secs if a button is pressed when the time lock is enabled.
	x	x	Off	Flashes	Off	Off	Off	Preconfiguration/configuration mode active $f_{\text{flash}} = 2 \text{ Hz}$
	x	x	Lights up red	Flashes	Off	Off	Off	Code card faulty $f_{\text{flash}} = 2 \text{ Hz}$ for 3 sec
	x	x	Green, 1 sec	Flashes	Off	Off	Off	Code card detected $f_{\text{flash}} = 2 \text{ Hz}$ for 3 sec
x	x	Off	x	x	x	Off	Time lock for buttons disabled	

1.No lane selected, for example

x = LED status has no meaning

CANopen Function Indicator

LED	[#1] BUS STATE	[#2] BUS ERR	[#3] PWR ERR/NO CODE	[#4] LANE AVAILABLE	[#5] FOLLOW LEFT	[#6] FOLLOW RIGHT	[#7] INTERNAL DIAGNOSTIC	
Color	Yellow	Red	Green/ red	Yellow	Yellow	Yellow	Red/ green/ yellow	Description
Status	Flickers	Flickers	x	x	x	x	x	Detection of auto baud rate $f_{\text{flicker}} = 10 \text{ Hz}$
	Flashes	x	x	x	x	x	x	"Preoperational" mode $f_{\text{flash}} = 2.5 \text{ Hz}$
	Flashes once	x	x	x	x	x	x	Stopped 1 x on briefly, 1 sec off
	Lights up	x	x	x	x	x	x	"Operational" mode

x = LED status has no meaning

CANopen Error Indication

LED	[#1] BUS STATE	[#2] BUS ERR	[#3] PWR ERR/NO CODE	[#4] LANE AVAILABLE	[#5] FOLLOW LEFT	[#6] FOLLOW RIGHT	[#7] INTERNAL DIAGNOSTIC	
Color	Yellow	Red	Green/r ed	Yellow	Yellow	Yellow	Red/ green/ yellow	Description
Status	Flickers	Flickers	x	x	x	x	x	Detection of auto baud rate $f_{\text{flicker}} = 10 \text{ Hz}$
	x	Flashes	x	x	x	x	x	General configuration error $f_{\text{flash}} = 2.5 \text{ Hz}$
	x	Flashes once	x	x	x	x	x	Warning limit reached 1 x on briefly, 1 sec off
	x	Flashes twice	x	x	x	x	x	"Control Event" error 2 x on briefly, 1 sec off
	x	Flashes 3 times	x	x	x	x	x	Synchronization error 3 x on briefly, 1 sec off
	x	Flashes 4 times	x	x	x	x	x	"Event Timer" error 4 x on briefly, 1 sec off
	x	Lights up	x	x	x	x	x	CANopen error

x = LED status has no meaning

2016-09

2.3 Accessories

Compatible accessories offer enormous potential for cost savings. Such accessories not only save you a great deal of time and effort when commissioning for the first time, but also when replacing and servicing our products.

If products are used in harsh ambient conditions, appropriate Pepperl+Fuchs accessories can be used to extend the service life of these products.

Model number	Description
PGV-CC25-0*	Code tape, various control codes
PGV*M-CA25-0	Position tape, starting position 0, various lengths
PGV-CR25	Repair tape
PGV25M-CD100-CLEAR	Protective film
PGV33M-CB19-BU	Colored tape; blue
PGV33M-CB19-GN	Colored tape; green
PGV33M-CB19-RD	Colored tape; red
PCV-SC12 PCV-SC12A	Grounding clip
V15-G-*M-PUR-CAN-V15-G	CANopen bus cable, M12 to M12, available in several different lengths
PCV-KBL-V19-STR-USB	USB cable unit with power supply, for service interface
V19-G-ABG-PG9-FE	Grounding terminal and plug (set)
ICZ-TR-CAN/DN-V15	Terminator for CANopen
VAZ-V1S-B	Stopping plug for M12 connector
V19-G-*M-*	Configurable connection cable ¹

1. Ask your contact person at Pepperl+Fuchs

3 Installation

3.1 Mounting the Read Head

Mount the PGV... read head on the automated guided vehicle using the four screws on the mounting adapter on the read head. Mount the read head in such a way that the lens with the ring light and camera module are directed toward the colored tape.

The mounting must be stable enough so that the read head does not leave its depth of focus range during operation.

The distance between the read head and the floor should be the same as the read distance of the read head.

Optimum Read Distance

Order designation	Read distance [mm]	Depth of focus [mm]	Field of vision (w x h) [mm]
PGV100*	100	±20	117 x 75
PGV150I*	150	±30	170 x 105

Hysteresis

If the read head has detected a colored tape, this colored tape can move in the Y direction from the zero point within the viewing window. The maximum Y value at which the read head can still capture this distance is designated as **Y Value Out** in the following table.

If the read head swivels onto a colored tape, the read head can capture the distance of the colored tape from the zero point only if the tape is less than a certain distance away from the zero point. This distance is designated as **Y value In** in the following table. The difference between Y Value Out and Y Value In is the hysteresis. See "Distance Output" on page 18.

Order designation	Max. Y Value Out [mm]	Min. Y Value In [mm]
PGV100*	60	45
PGV150I*	60	60

Read Head Dimensions

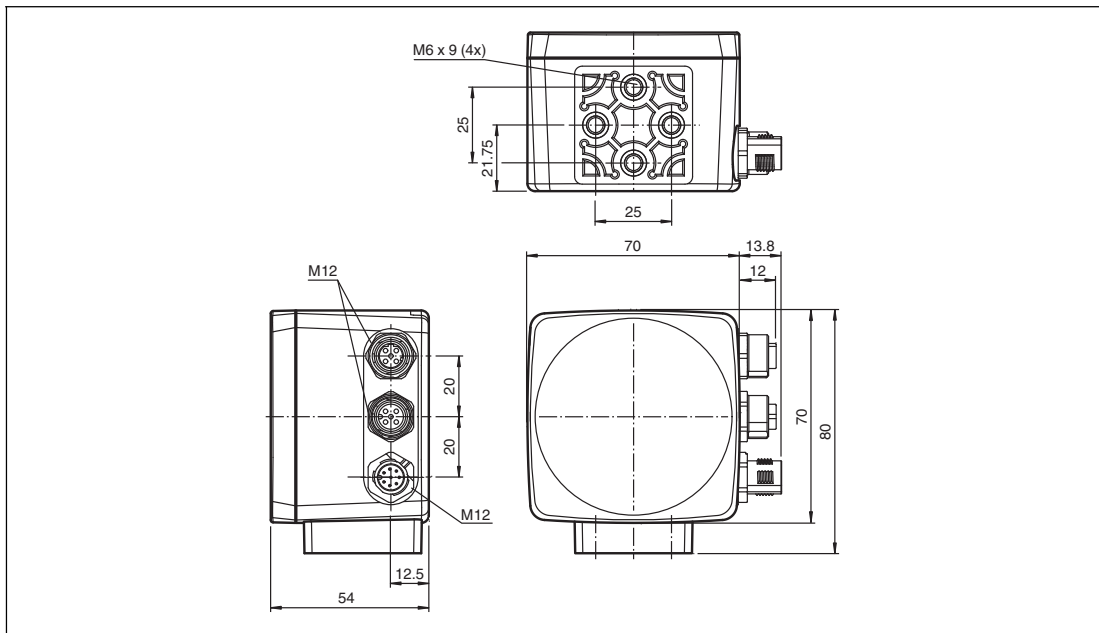

Figure 3.1 Housing *-F200-*

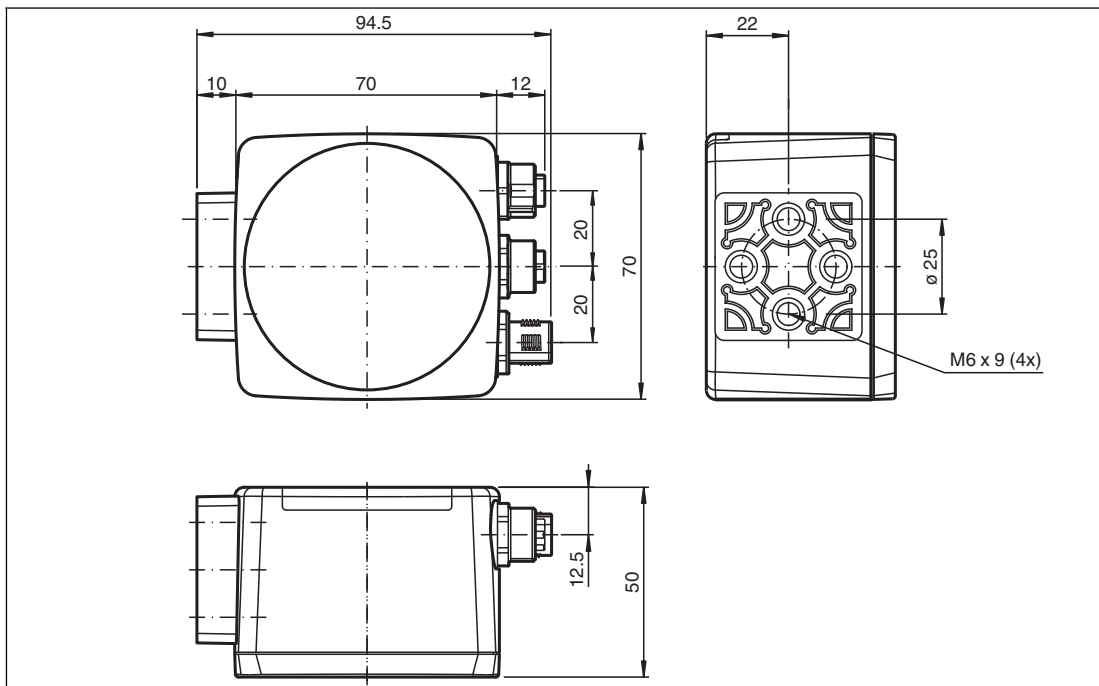

Figure 3.2 Housing *-F200A-*



Caution!

When selecting the length of the mounting screws, ensure that the maximum insertion depth of the screws in the threaded inserts on the read head is 8 mm.

Using longer screws may damage the read head.



Caution!

The maximum torque of the mounting screws must not exceed 9 Nm.
Tightening the screws to a higher torque may damage the read head.

3.2 Mounting the Colored Tape and Code Tape

Colored tape

The colored tape must be flexible, conformable, and resistant to abrasion, with a matte finish.

The colored tape must meet the following specifications:

- Tape width: 10 mm ... 40 mm
- Color of the tape
 - Blue = RAL 5015
 - Green = RAL 6032
 - Red = RAL 3001
- Tape thickness > 0.1 mm
The thickness of the tape is irrelevant to read head operation.
- Breaking load > 25 N/cm
- Breaking elongation > 180%
- Adhesive strength > 2 N/cm
- Temperature resistance: -20 °C ... 70 °C

Secure the colored tape to the floor such that the following conditions are met:

- Data Matrix code tapes for positioning are used instead of the colored tape.
- Data Matrix control codes are positioned parallel to the colored tape.

Color Selection

Select the color of the colored tape so that the contrast between the floor color and the color of the colored tape is as great as possible. Ideally, use the complementary color.

Due to the integrated lighting of the read head, some floor colors appear to be different in the camera. If you have problems with the color selection of the colored tapes, please consult your contact at Pepperl+Fuchs.



Mounting the Colored Tape

1. Clean the surface of any greasy or oily deposits and dust.
2. Ensure that the surface is dry, clean, and stable.
3. Please observe the following section "Basics" when mounting the colored tape and, if necessary, the instructions from the colored tape manufacturer.



Note!

Priority

Data Matrix code tapes and Data Matrix tags have priority over colored tapes or colored lanes. If the read head detects a Data Matrix code tape or Data Matrix tags in the field of view, colored tapes or colored lanes in the field of view are ignored.

Cleaning Colored Tape/Code Tape

Significant contamination on the colored or code tapes can impair the detection by the read head. Clean the colored and code tapes with isopropanol if necessary. If the contamination is severe, you can use a non-corrosive plastic cleaner, e.g., Caramba®.



Note!

To avoid polishing the surface, do not apply strong pressure when cleaning. A shiny surface of the colored or code tapes leads to impairment in detection by the read head.

Basics

The read head detects a colored tape on a floor as a lane. The width of the colored tape must be between 10 mm and 40 mm; the default width is 18 mm. The zero point is located in the center of the colored tape. You can use 3 defined colors. See the section entitled "Colored tape"

The sensor always moves in the X direction. In the sensor's field of view, X indicates an upward movement.

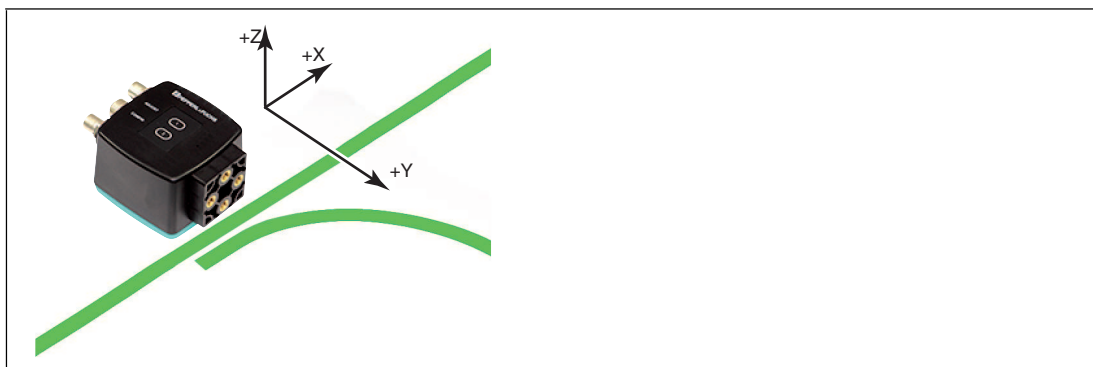

Figure 3.3 Field of view and coordinates of the sensor

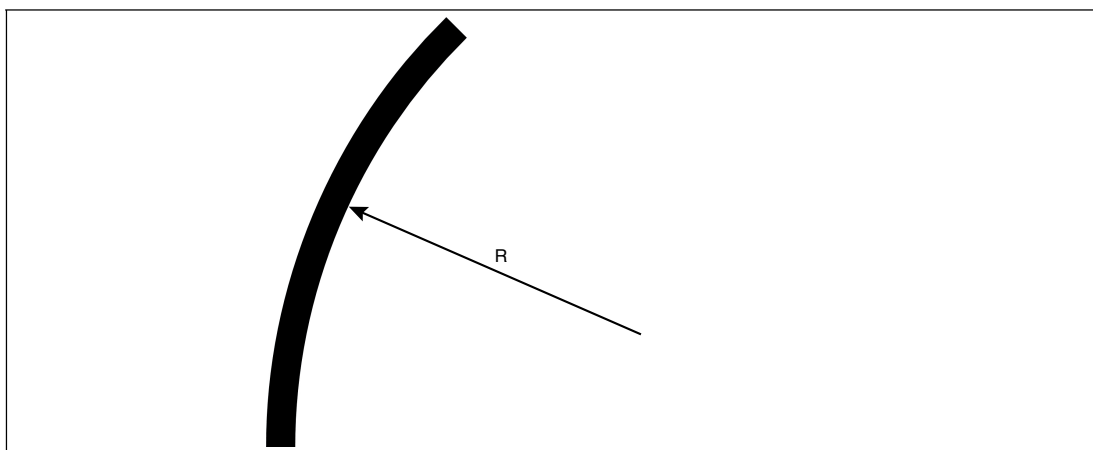

Figure 3.4 Curve radius: $R \geq 50$ cm

Select a curve radius that can handle the turning circle of your automated guided vehicle. The colored tape must always be located in the reading window of the read head.

Angle Output



Note!

Angles are specified as absolute values. The respective value is calculated from the resolution selected under "Angle Resolution". With a resolution of 0.1° , an angle of 60° is output as $60^\circ / 0.1^\circ = 600$.

The read head detects a change of the angle of the colored tape and the Data Matrix code tape and outputs this value to the controller. The output value is different for colored tapes and Data Matrix code tapes.

Colored tape

The read head detects the angle in relation to the tracked lane with a resolution of 360 (corresponds to 1°). The angle is specified relative to the tracked lane because a colored tape does not include any direction information. The output angle covers the range from -45° to 45°. The resolution is 1°.

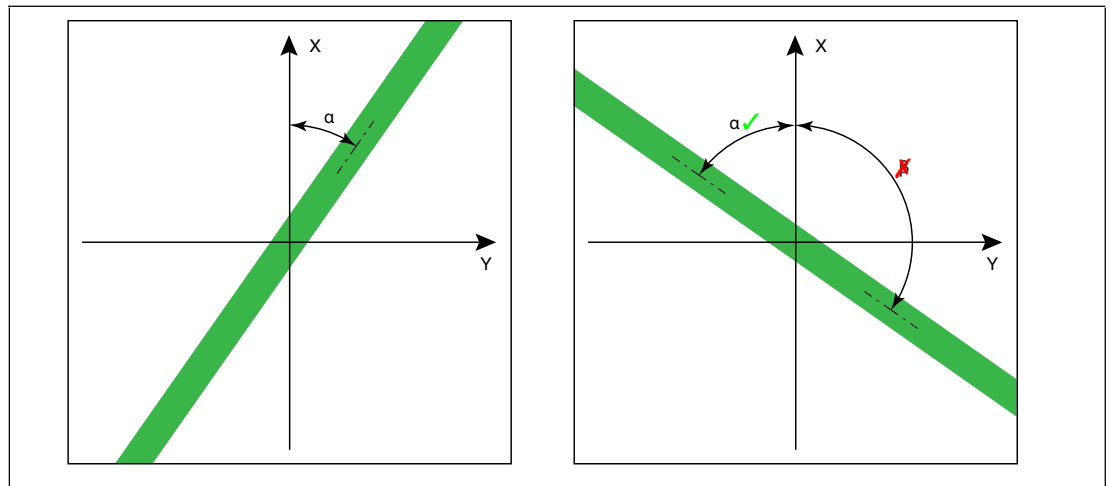

Figure 3.5 Relative angle

Data Matrix code tape

The read head detects the absolute angle in relation to the tracked lane with a maximum resolution of 0.1°. The angle is specified absolutely relative to the tracked lane, since a Data Matrix code contains tape direction information. The output angle covers the range from 0° to 360°. The resolution can be set to the following values:

- 0.1°
- 0.2°
- 0.5°
- 1°

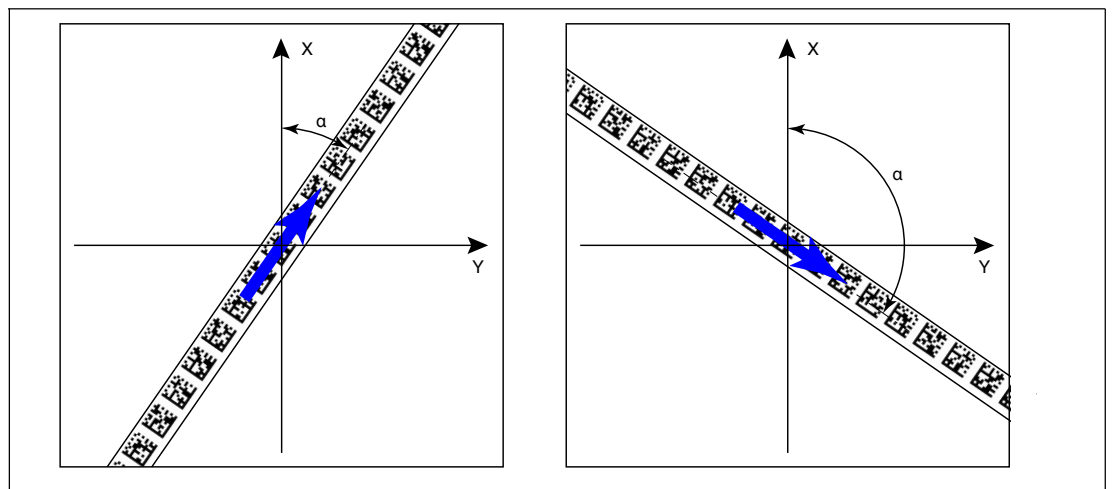

Figure 3.6 Absolute angle



Distance Output

The read head detects the distance from the zero point in the Y direction of a colored tape or a Data Matrix code tape and outputs this value to the controller. The output value is different for colored tapes and Data Matrix code tapes due to the lack of an X position for colored tapes.

Colored tape

The read head outputs the Y value at which the colored tape intersects the Y axis as the distance.

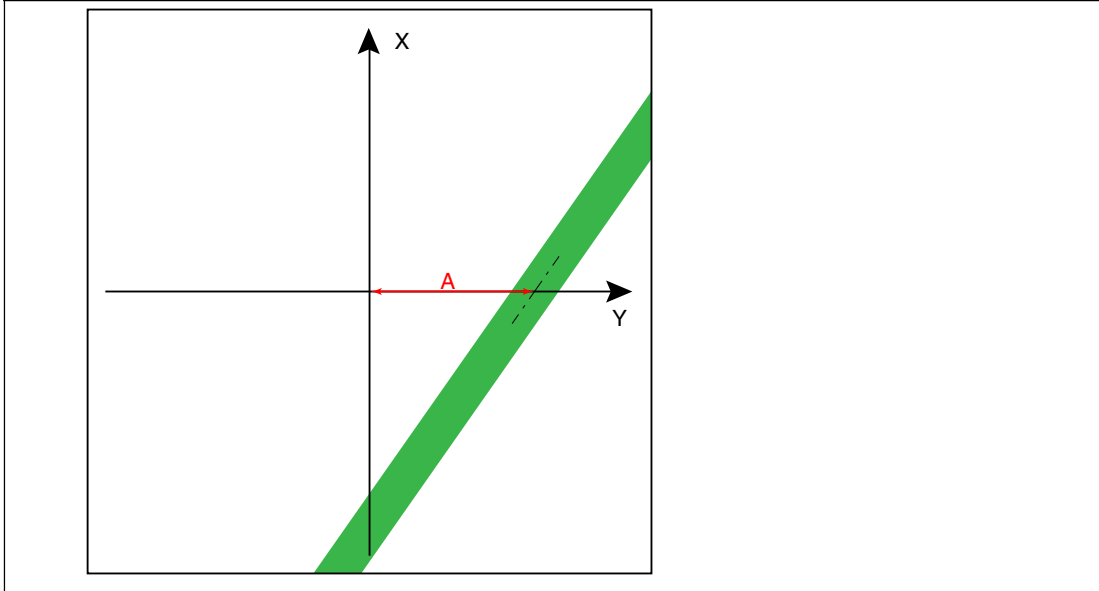

Figure 3.7 Distance A for colored tape

Data Matrix code tape

The read head indicates the vertical distance of the zero point in relation to the Data Matrix code tape.

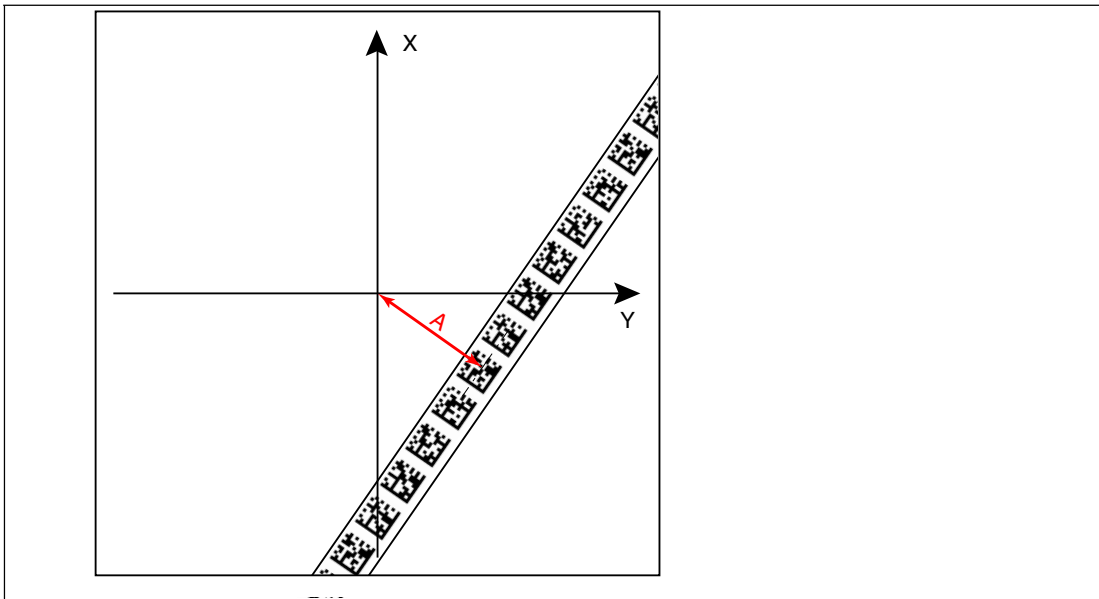

Figure 3.8 Distance A for Data Matrix code tape

Branches

The read head detects one lane at the lower edge of the field of vision and two lanes at the upper edge of the field of vision; the read head indicates this as a branch.

The read head detects two lanes at the lower edge of the field of vision and one lane at the upper edge of the field of vision; the read head indicates this as an intersection.

Branches or intersections can be displayed as follows:

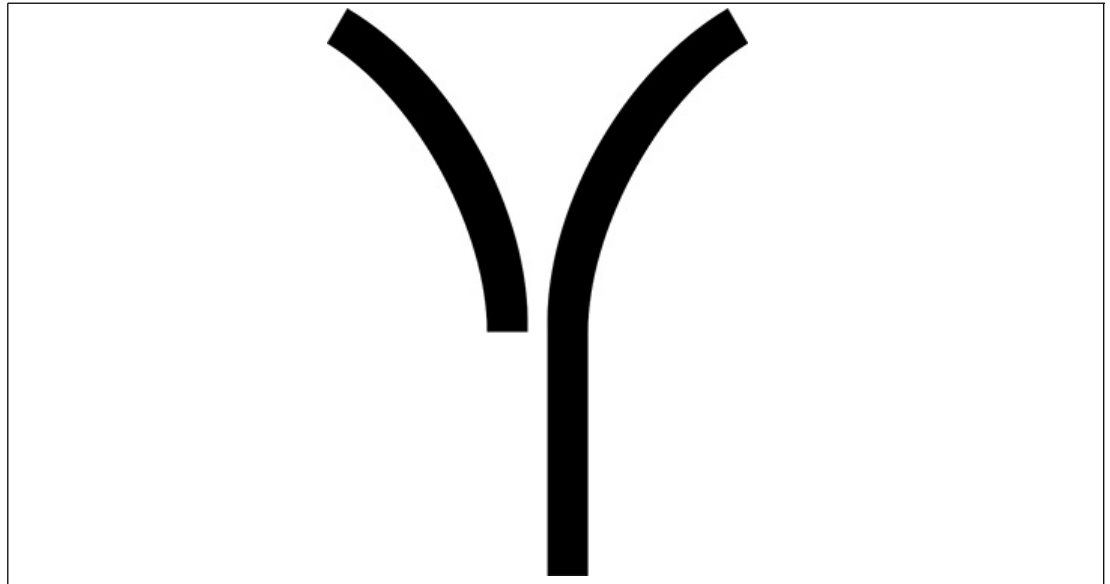

Figure 3.9 Separate lane branches off/converges

The read head can make the following direction decisions based on the lane and possible branches:

- Follow left-hand lane
- Straight ahead
- Follow right-hand lane

The direction decision is signaled to the read head via the controller. If there is no direction decision, the read head displays an error message.

Code Tapes for Control and Positioning

In addition to tracking the lane, the read head can also detect Data Matrix codes. This process involves evaluating both control and position information. Data Matrix control codes are used as event markers. Control codes provide information on branches. Data Matrix code tapes for positioning indicate the absolute position of the read head.

Note the following conditions:

Data Matrix code tapes for positioning are used instead of the colored tape.

Data Matrix control codes are used in tandem with the colored tape or Data Matrix position code.

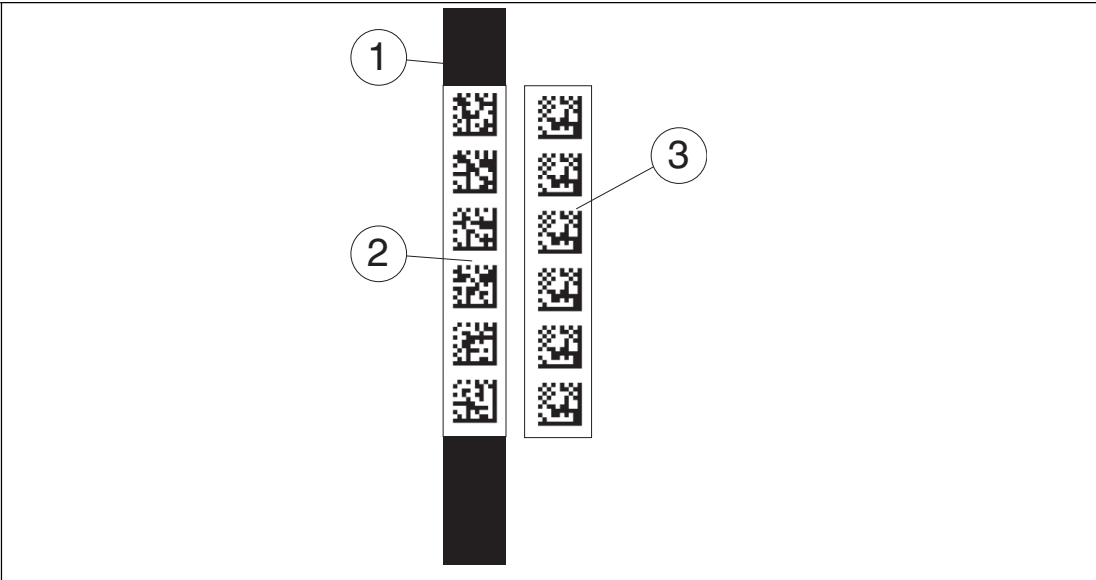

- ① Colored tape
- ② Data Matrix position code
- ③ Data Matrix control code

Branches or intersections with position information can be displayed as follows:

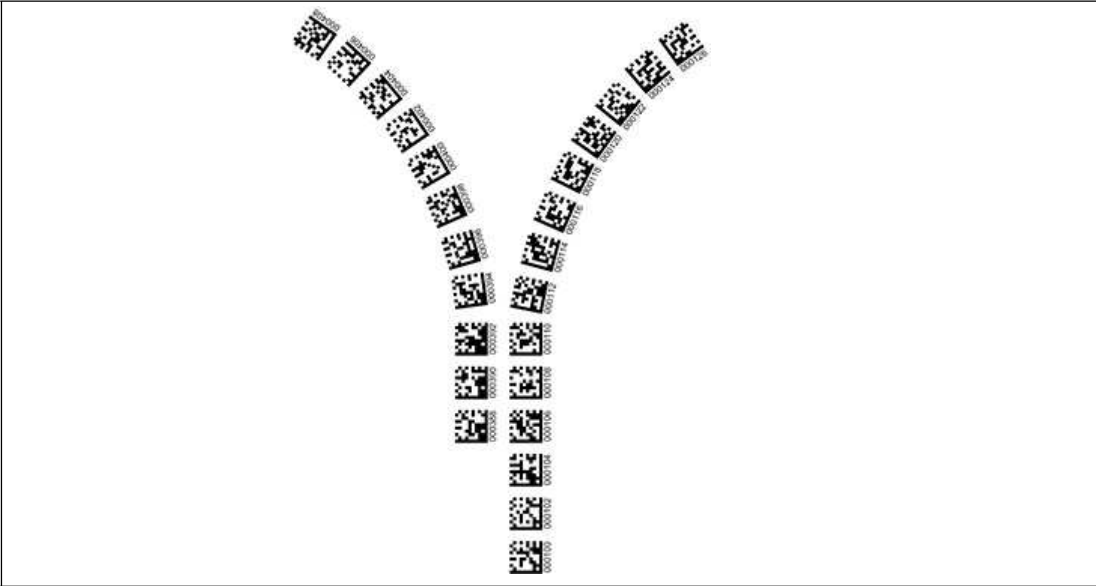

Figure 3.10 Separate lane branches off/converges

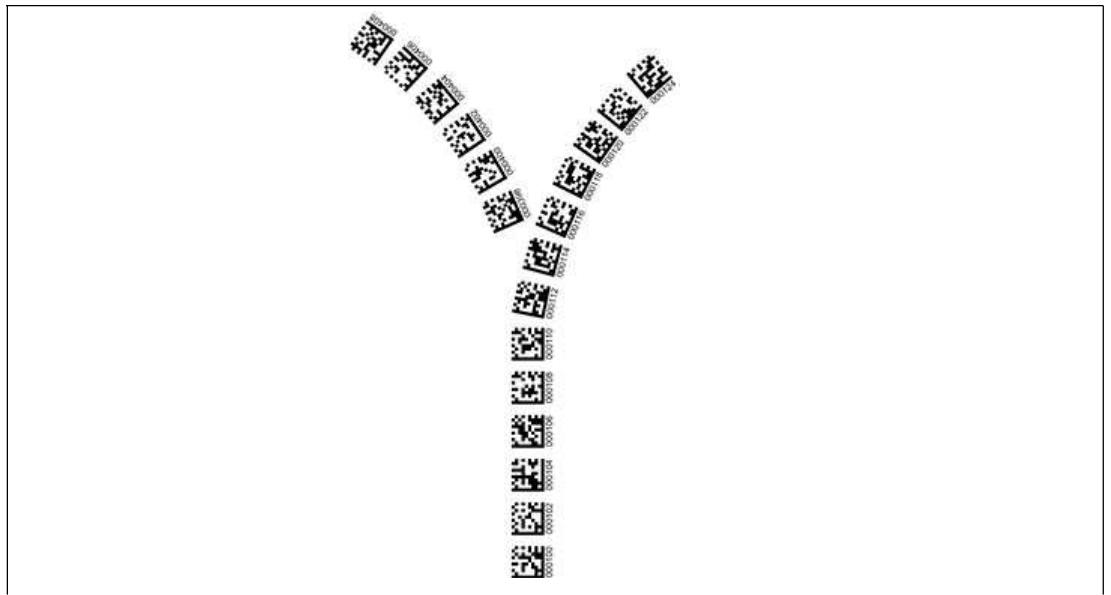

Figure 3.11 Same lane branches off/converges



Note!

Direction Decision

The direction decision at a branch of a Data Matrix code tape remains in effect until the read head has moved more than 50 cm from the branch.

It is not possible to change the direction decision within a branch!



Note!

Priority

Data Matrix code tapes and Data Matrix tags have priority over colored tapes or colored lanes. If the read head detects a Data Matrix code tape or Data Matrix tags in the field of view, colored tapes or colored lanes in the field of view are ignored.



Note!

Branches/Intersections with Data Matrix Position Code

Observe the following guidelines less than 1 m before and after branching or intersection of a lane with a position code:

- The position codes of the main lane must run continuously for 2 m. The position codes of the branching/intersecting lane must run continuously for 1 m. The read head outputs the X-value of the Data Matrix code tape that is specified the direction decision. See chapter 4.1.
- Do not use repair tape.
- Do not use colored tape.
- The difference between the absolute position of the main lane and the starting position of the branching/intersecting lane must be greater than 1 m.

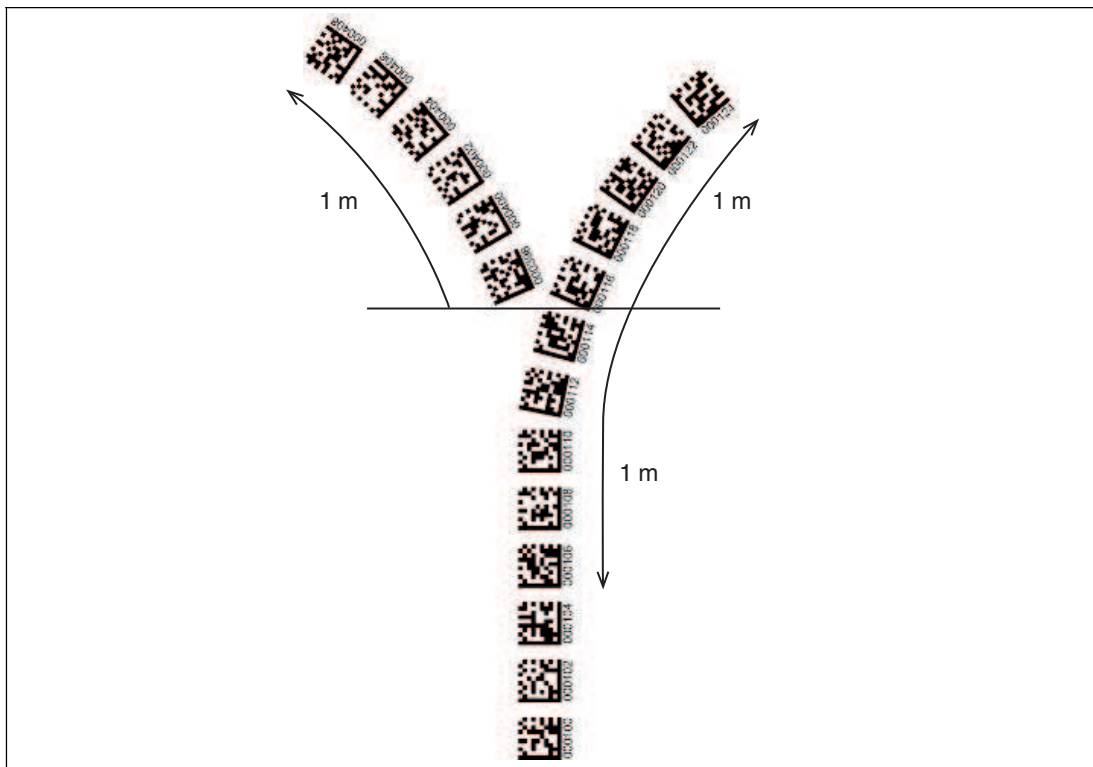

Figure 3.12 Distances

Behavior of the Read Head at Branches and Corners

The read head behaves differently depending on the type of branch and the specified lane. The read head must know the upcoming direction decision.

A second lane branches off to the left from the straight lane:

The read head follows the straight lane if the direction decision "follow right-hand lane" has been made.

A second lane branches off to the right from the straight lane:

The read head follows the straight lane if the direction decision "follow left-hand lane" has been made.

A single lane with a position code turns to the left or right:

The read head follows the position code if the direction decision "straight ahead" has been made.



Note!

Loss of Information

Ensure that Data Matrix codes are not positioned over one another at a branch, as otherwise data may be lost.

It is not permitted to create a mixture of lanes made from colored tape and Data Matrix codes at branches or intersections.

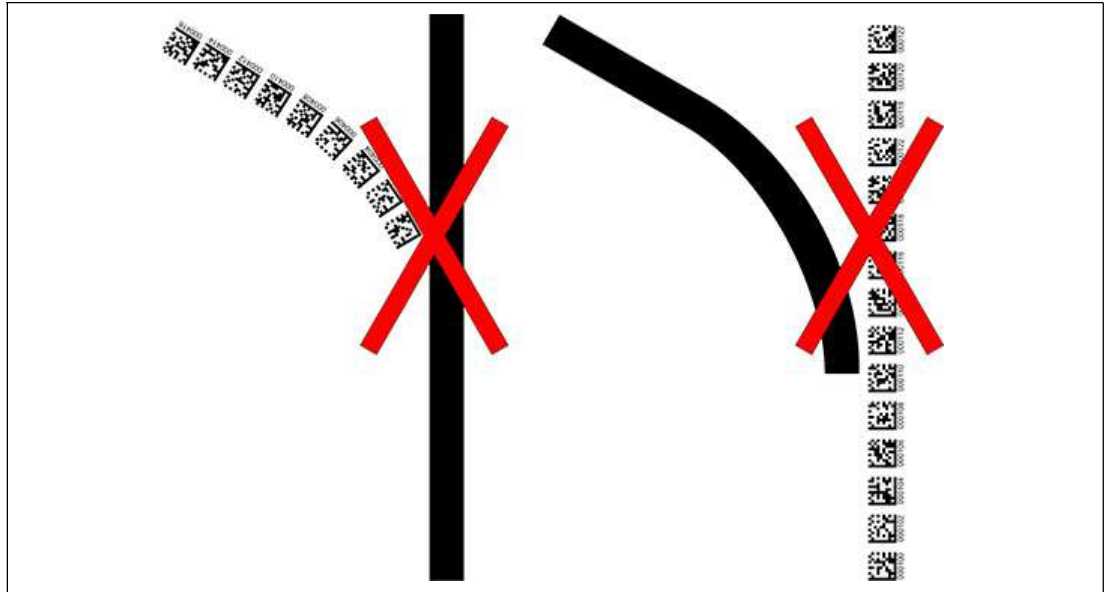

Figure 3.13 Mixture of lanes with colored tape and Data Matrix codes

Control codes can be mounted in the immediate vicinity of a branch with Data Matrix codes for positioning, but not near an intersection. The control code must be mounted directly next to the guiding lane.

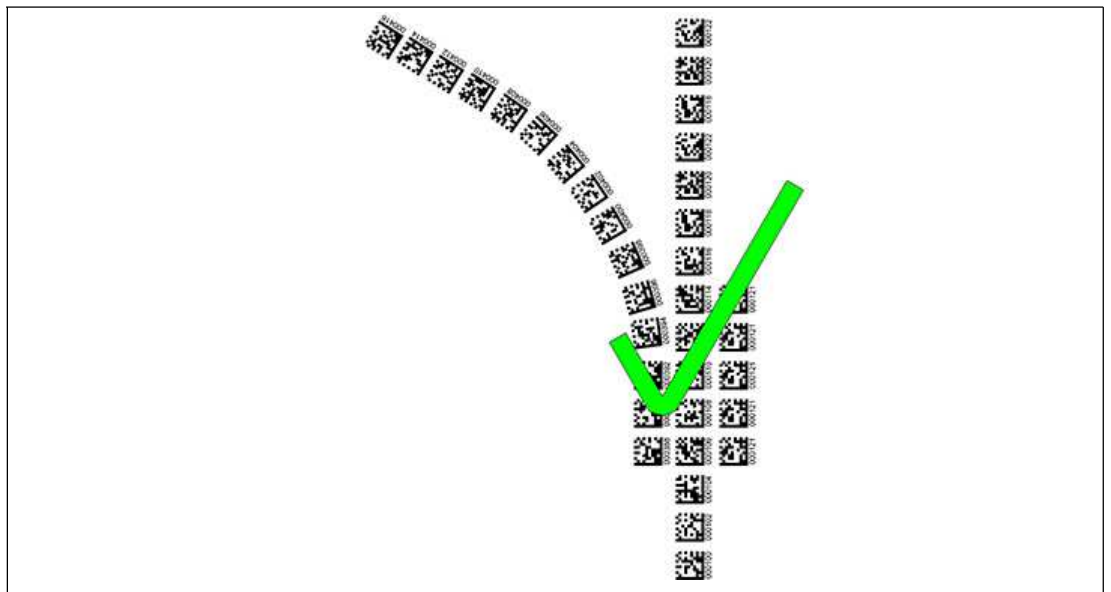

Figure 3.14 Branch with control code

Distances

To ensure that the read head can clearly detect and assign colored tapes and Data Matrix codes, minimum and maximum distances must be observed when creating the lanes.

Offset V between position codes of a lane must not be greater than 5 mm.

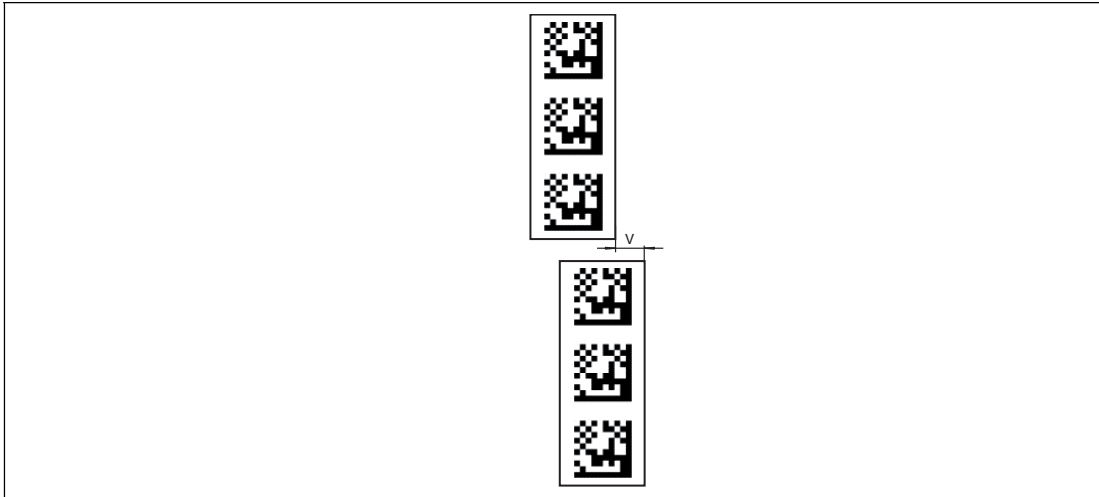

Figure 3.15 Offset: $0 \text{ mm} \leq V \leq 5 \text{ mm}$

The distance D between the colored tapes at a branch or intersection as a separate lane must not exceed 15 mm. The distance decreases if the guiding colored tape cannot be detected by the read head in the center of the reading window.

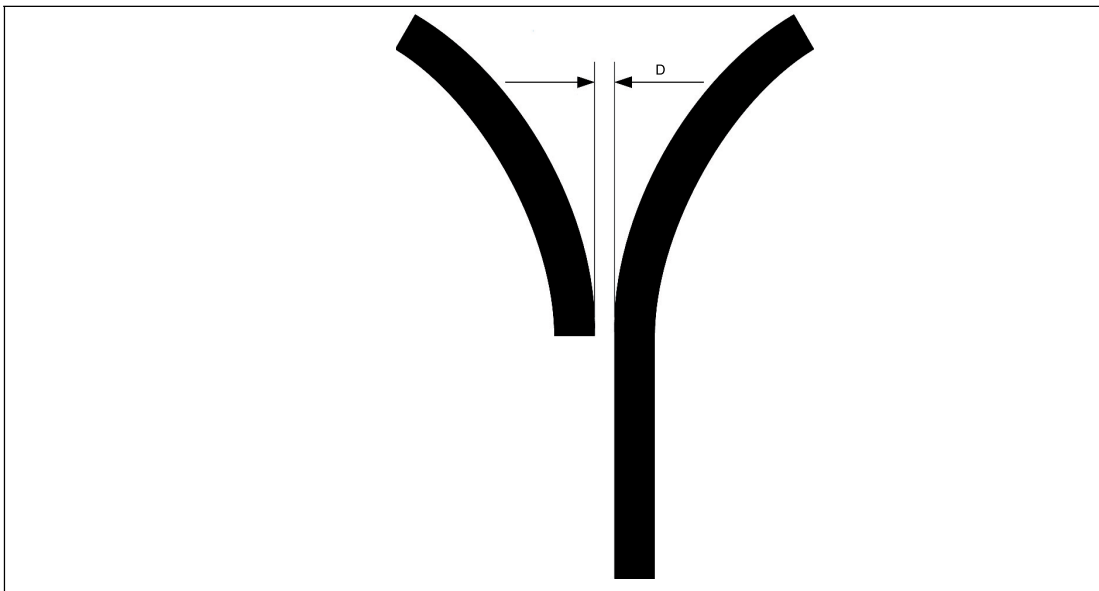

Figure 3.16 Distance: $7.5 \text{ mm} \leq D \leq 15 \text{ mm}$

The distance between the Data Matrix code tapes at a branch or intersection as a separate lane must be between 0 mm and 5 mm.

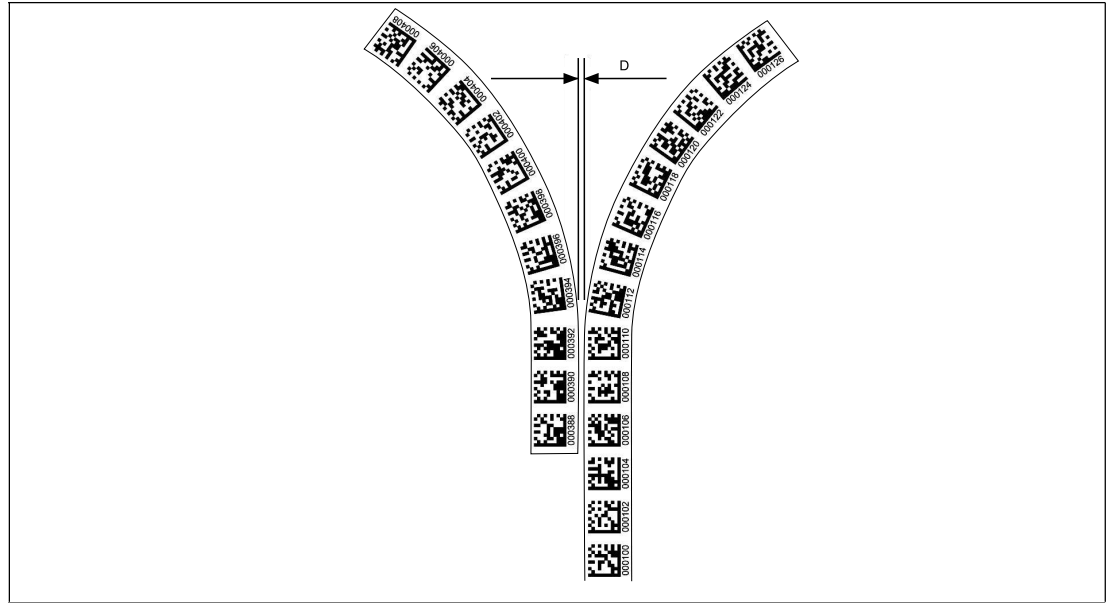

Figure 3.17 Distance: $0 \text{ mm} \leq D \leq 5 \text{ mm}$

The distance between a colored tape and a Data Matrix control code must be between 0 mm and 5 mm.

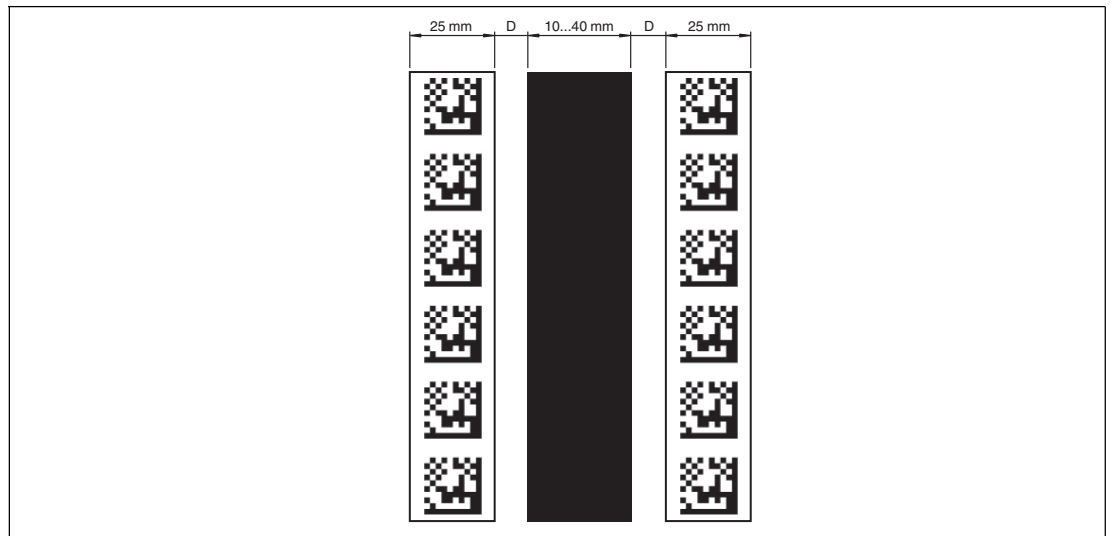

Figure 3.18 $0 \text{ mm} \leq D \leq 5 \text{ mm}$

The distance between a Data Matrix position code and a Data Matrix control code must be between 0 mm and 5 mm.

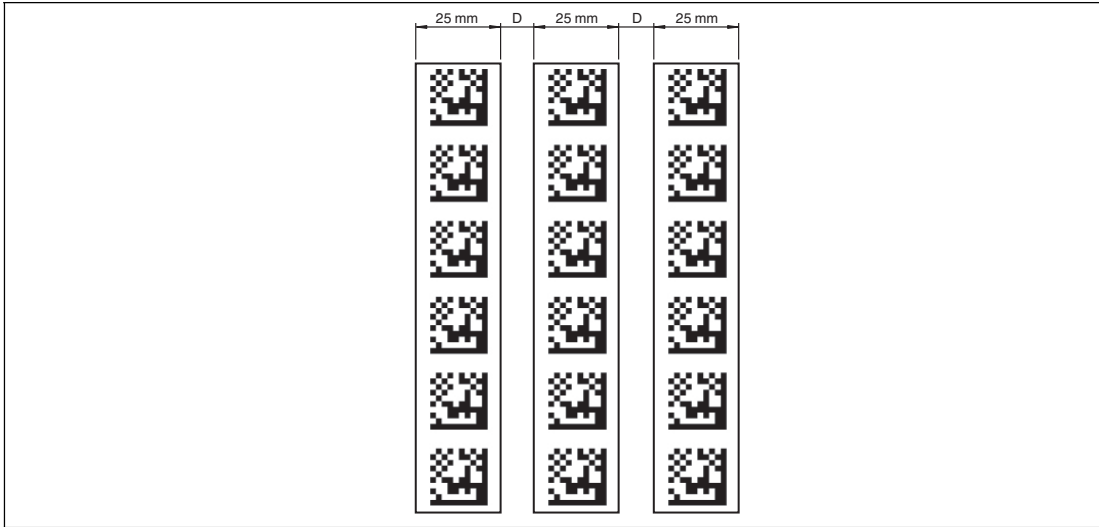

Figure 3.19 $0 \text{ mm} \leq D \leq 5 \text{ mm}$

A lane can switch from a colored tape to a Data Matrix code tape and back again as often as required. The distance between the colored tape and the edge of the Data Matrix code must be between 0 mm and 10 mm

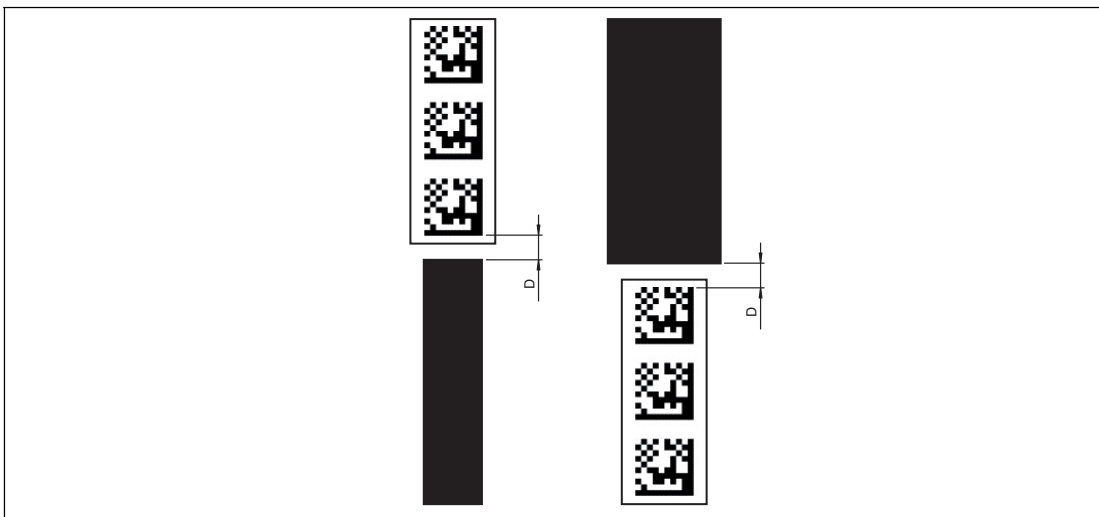

Figure 3.20 $0 \text{ mm} \leq D \leq 10 \text{ mm}$

The Y value does not change if the colored tape and the Data Matrix code tape are aligned. Ensure that the center line of the colored tape and the center line of the Data Matrix code are on a line.



Caution!

Alignment

The Data Matrix code is not on the center line of the code tape.

The code tape is made of silicone-free polyester film. A position marker appears every 100 mm along the lower edge of the code tape (see "Code Tape Dimensions"). This position marker is used for various functions, including precise positioning of the code tape during installation. The reverse side of the code tape carries a permanent modified acrylate-based adhesive. Affix the self-adhesive code tape along the desired travel path. To do so, proceed as follows:



Installing the Code Tape

1. Clean the surface of any greasy or oily deposits and dust.
2. Ensure that the surface is dry, clean, and stable.
3. Pull away a few centimeters of the protective film at the beginning of the code tape. Place the code tape at the precise point of the required starting position on the surface, and press to attach.
4. Then affix the code tape along the desired travel path. Remove the protective film gradually so that the code tape does not accidentally adhere to the surface in the incorrect position. When affixing, ensure that the code tape does not crease or trap air bubbles.

↳ The adhesive on the code tape hardens after 72 hours.



Note!

Thermal Expansion of the Code Tape

The affixed code tape corresponds to the heat expansion coefficient of the surface with regard to its thermal expansion.

Code Tape Dimensions

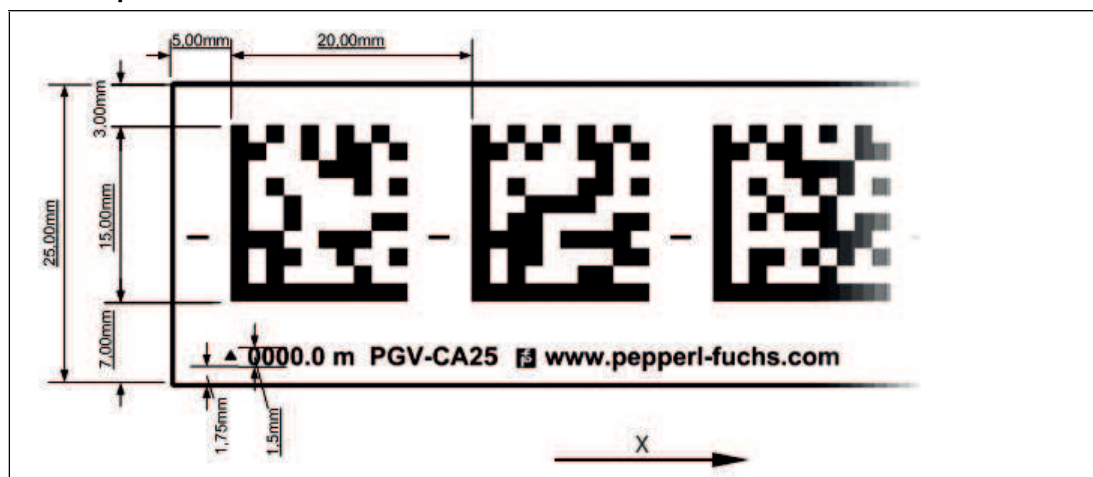

Figure 3.21 The center line indicates the center of the code tape and not the center of the code

Position the code tape so that the **www.pepperl-fuchs.com** label and the position markings are to the right of the Data Matrix code in the X direction. The position values then increase along the X direction.

Data Matrix Code Tapes with a Starting Position of 0 m

Order designation	Description
PGV10M-CA25-0	Code tape, length: 10 m
...	...
PGV100M-CA25-0	Code tape, length: 100 m

Table 3.1 See also data sheet PGV*-CA25-* at www.pepperl-fuchs.com

Data Matrix control codes

Order designation	Description
PGV-CC25-001	Code tape, Control Code 001, length: 1 m
...	...
PGV-CC25-999	Code tape, Control Code 999, length: 1 m



Caution!

Stop edges

If you attach another code tape at the end of a previous code tape, the code pattern of 20 mm must be retained.



Note!

Bends

If mounting the code tape in corners, cut the code tape several times as illustrated.

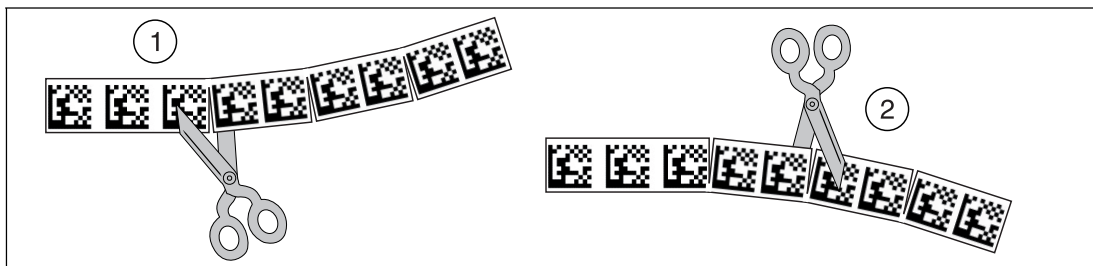

- ① Bend to the left
- ② Bend to the right

Data Matrix Tag

A Data Matrix tag contains position information in addition to a specific number. A cross in the center of the Data Matrix tag marks the zero point. The X and the Y axes are marked starting from the zero point. The black arrow indicates the positive axis and the white arrow indicates the negative axis.

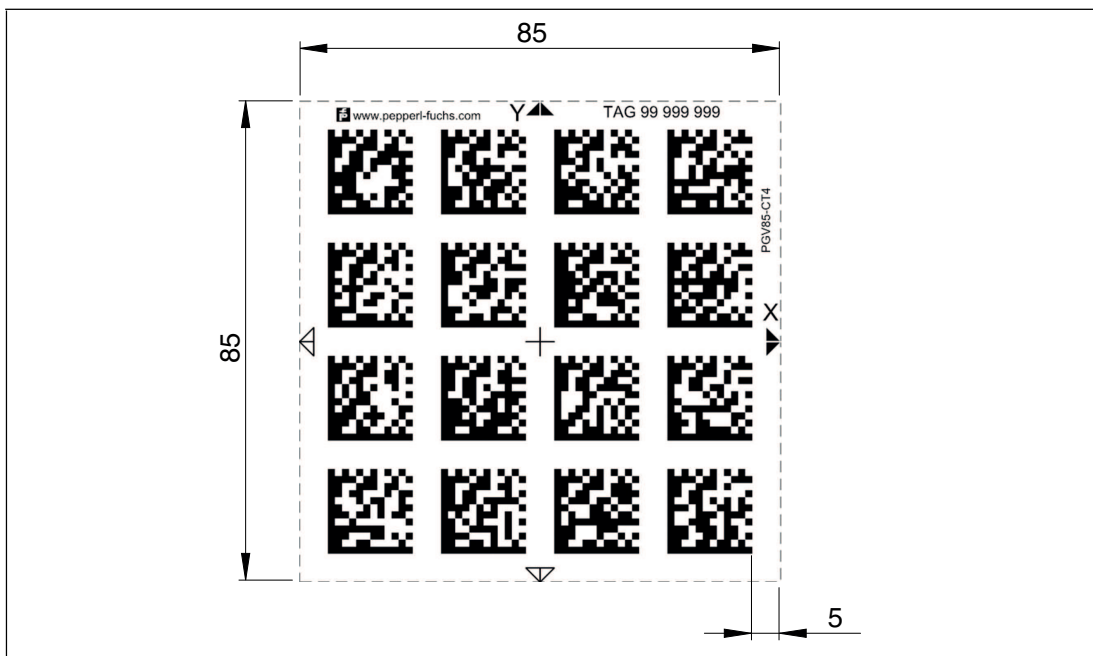

Figure 3.22 Data Matrix tag with the number 99999999 and position information

3.3 Electrical Connection

The reader is connected electrically via an 8-pin M12 x 1 connector on the side of the housing. The power is supplied via this connection. The configurable inputs and outputs on the reader are located at this connection.

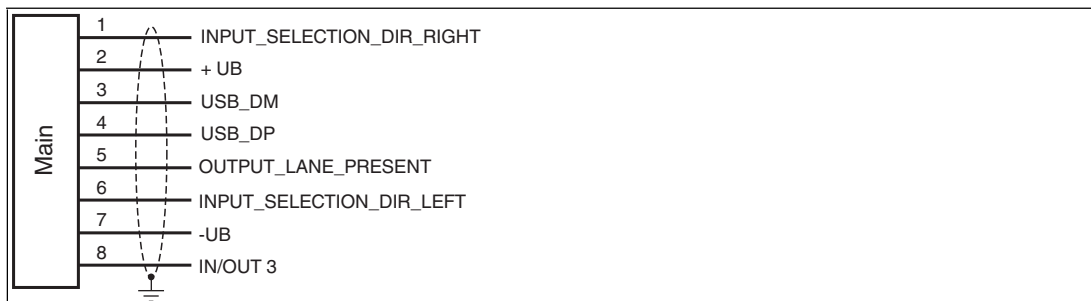

Figure 3.23

Connector Assignment



Figure 3.24

Color Assignment

Pepperl+Fuchs single-ended cordsets (female) are manufactured in accordance with EN60947-5-2. When using a type V19-... () female cordset with an open cable end on the **Main** connection, the colors are assigned as follows:

Connection pin	Strand color	Color abbreviation
1	White	WH
2	Brown	BN
3	Green	GN
4	Yellow	YE
5	Gray	GY
6	Pink	PK
7	Blue	BU
8	Red	RD

Shielding Cables

The shielding of connection lines is required to suppress electromagnetic interference. Establishing a low resistance or low impedance connection with the conductor or equipotential bonding circuit is a particularly important factor in ensuring that these interference currents do not become a source of interference themselves. Always use connection lines with braided shield; never use connection lines with a film shield. The shield is integrated at both ends, i.e., in the switch cabinet or on the controller **and** on the read head. The grounding terminal available as an accessory allows easy integration in the equipotential bonding circuit.

In exceptional cases, the shielding of a connection at one end may be more favorable if

- An equipotential bonding cable is not laid or cannot be laid.
- A film shield is used.

The following points relating to shielding must also be noted:

- Use metal cable clips that cover large areas of the shield.
- After installing the cable shield in the control cabinet, place it directly on the equipotential bonding rail.
- Direct the protective grounding connections to a common point in a star configuration.
- The cross-section of the cables used for grounding should be as large as possible.

Additional Ground Connection

Model number	Description
PCV-SC12	Clip for mounting an additional ground connection.
PCV-SC12A	



Caution!

Damage to the device

Connecting an alternating current or excessive supply voltage can damage the device or cause the device to malfunction.

Electrical connections with reversed polarity can damage the device or cause the device to malfunction.

Connect the device to direct current (DC). Ensure that the supply voltage rating is within the specified device range. Ensure that the connecting wires on the female cordset are connected correctly.

3.4 CANopen Connection

The PGV... reader is connected to CANopen via a 5-pin M12 x 1 **BUS in** connector and a 5-pin M12 x 1 **BUS out/term** device socket, located on the side of the housing.

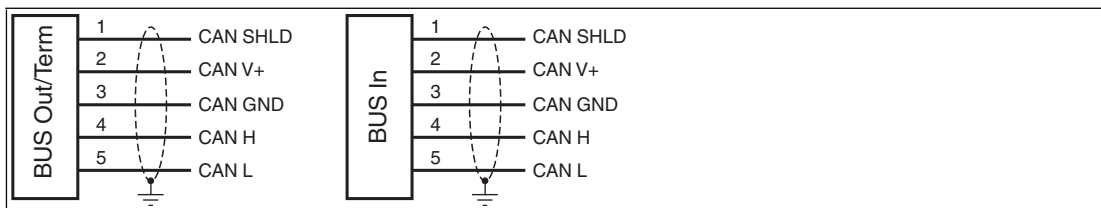

Figure 3.25

Connector Assignment



Figure 3.26

For details of suitable CANopen cables, see chapter 2.3.

4 Commissioning

4.1 Specifying the First Direction Decision

To ensure that the read head does not report any error messages after being switched on, a direction decision must be specified. You can control the direction decision via the INPUT_SELECTION_DIR_RIGHT and INPUT_SELECTION_DIR_LEFT inputs. .

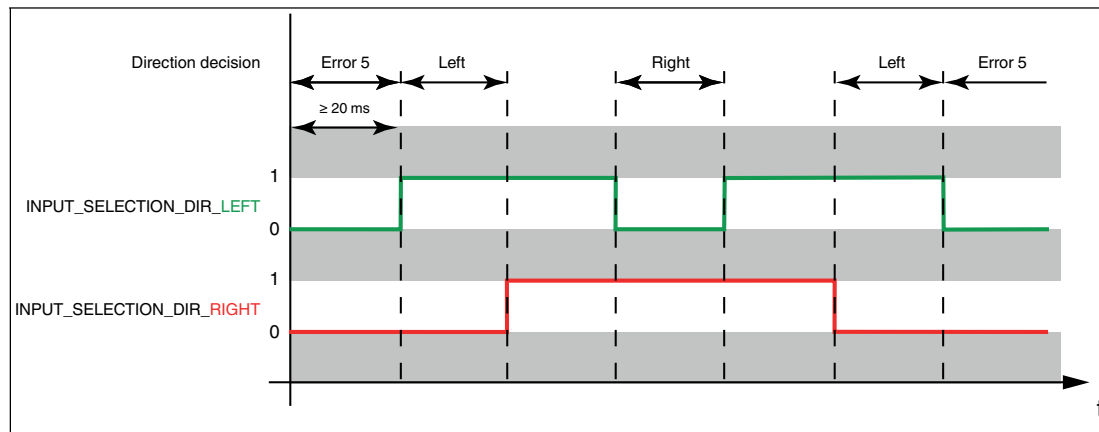

Figure 4.1

Direction decision via protocol

If a decision on the direction to take is sent to the read head via a protocol, the input signals are ignored until the read head is reset. .

4.2 Direction Decision

The read head has several ways of following colored tapes and Data Matrix code tapes depending on the parameterization. Depending on the input signal, the read head follows the right-hand, the left-hand, or the better lane.

Direction Decision via Input Signal

Input 2 INPUT_SELECTION_DIR_LEFT	Input 1 INPUT_SELECTION_DIR_RIGHT	Direction Decision
0	0	No lane is selected Error code 5
0	1	Follow right-hand lane
1	0	Follow left-hand lane
1	1	Colored tape: follow lane with better quality Data Matrix code tape: follow lane with more detailed position information Data Matrix tag: no significance

Table 4.1



Following Lane with Better Quality

You can parameterize the read head so that it follows the better quality color lane.

Example

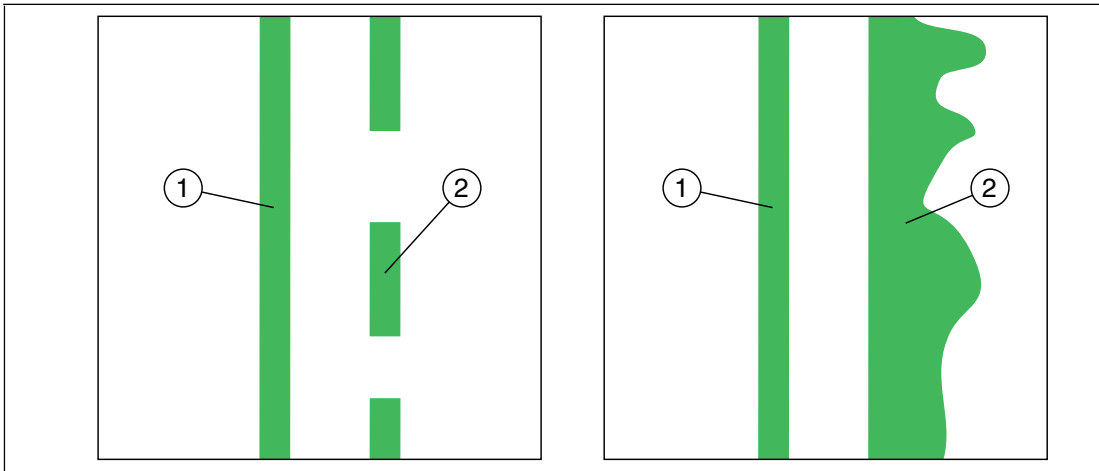

Figure 4.2 ① - Better color lane
 ② - Worse color lane

Following Lane with More Detailed Position Information

You can parameterize the read head so that it follows the Data Matrix code tape that continues the current location information.

Example



Figure 4.3 ① - More detailed position information
 ② - New position Information

4.3 Parameterization of Fieldbus Address and Baud Rate

Before the reader can communicate with the CANopen fieldbus, the **fieldbus address** and **baud rate** parameters must be set.

Parameterization Using Code Cards

During external parameterization, the reader scans the special code cards optically and configures the relevant parameters. Simply hold the corresponding code cards at the correct distance in front of the lens on the reader.

Fieldbus Address

During the first start process, the reader adopts the stored bus address 003 (= default). To change the fieldbus address of the reader, use code cards for parameterizing the fieldbus address 001 to 125. These code cards are printed in a separate manual.

You can find the manual for the code cards for configuring the fieldbus address at www.pepperl-fuchs.com. See chapter 4.3.1.

Baud Rate

Data on the CANopen network can be exchanged at various baud rates between 10 kBaud and 500 kBaud. The reader supports the following baud rates:

Baud Rate
10 kBaud
20 kBaud
50 kBaud
125 kBaud
250 kBaud (= default)
500 kBaud
1 MBaud
Auto baud rate

The code cards for parameterizing the baud rate from 10 kBaud to 1 MBaud and the auto baud rate are printed in the appendix to this manual.

See chapter 6.3.

Code Cards for Controlling Parameterization

The code cards for controlling parameterization are printed in the appendix to this manual.

See chapter 6.2.



Note!

For external parameterization using code cards, either copy or print the required pages of the manual. Cut out the required code cards to prevent the reader from mistakenly detecting another code card on the same page.

However, if you parameterize the reader using the manual, cover the code cards that you do not need with a sheet of paper.



Activating Parameterization Mode

1. Press button 2 on the rear of the reader and hold for longer than 2 seconds.
↳ Yellow LED3 now flashes.
2. Hold the "ENABLE" code in front of the camera system on the reader to trigger final activation
↳ If the "ENABLE" activation code is detected, the green LED2 lights up for 1 sec. If the activation code is not detected, LED2 lights up red for 2 seconds.



Parameterization

Place the parameterization code in the field of vision of the camera module.

↳ After the parameterization code is detected, the green LED2 lights up for 1 sec. In the event of an invalid parameterization code, LED2 lights up red for 2 seconds.



Exiting Parameterization Mode

Hold the "STORE" code in front of the camera system on the reader to save the configuration

↳ When the "STORE" memory code is detected, the green LED2 lights up for 1 sec. The parameterization is stored in the nonvolatile memory of the reader and parameterization mode is terminated. Parameterization of the reader is now complete. If the memory code is not detected, LED2 lights up red for 2 seconds.



Note!

If you press button 2 briefly in parameterization mode, this mode is closed immediately. Any parameter changes that are made but have not yet been saved are discarded. The reader operates with the last valid parameters that were saved.



Note!

When the parameterization mode is activated, there is no data exchange via the bus.

4.3.1

Product documentation on the internet

You can view all the relevant documentation and additional information on your product at <http://www.pepperl-fuchs.com>. Simply enter the product name or model number in the **Product/Key word search** box and click **Search**.

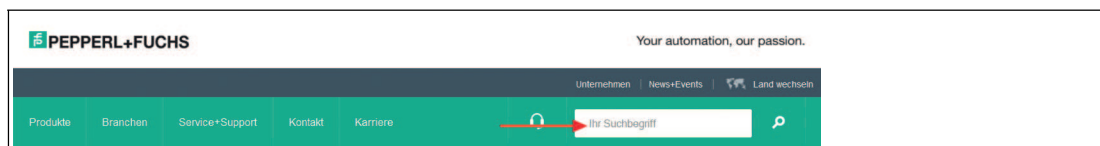

Select your product from the list of search results. Click on the information you require in the product information list, e.g., **Technical documents**.



A list of all available documents is displayed.

4.4 EDS Configuration File

To assist with the configuration, you can download the EDS file from the download area of our Internet homepage <http://www.pepperl-fuchs.com>. Simply enter the product name or item number in the **Product/Keyword** search box and click **Search**.

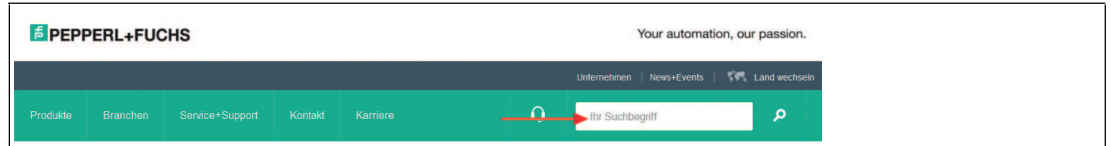

Select your product from the list of search results. Click on the information you require in the product information list, e.g., **Software**.

A list of all available downloads is displayed.

5 Operation and communication

5.1 Data Exchange in the CANopen Bus

5.1.1 General Information about CANopen

CANopen is a multimaster-compliant fieldbus system based on the CAN (Controller Area Network).



Figure 5.1

Devices on the CANopen fieldbus communicate via message identifiers rather than via addresses. This allows all devices to access the fieldbus at any time. Fieldbus access is according to the CSMA/CA principle (Carrier Sense Multiple Access/Collision Avoidance). Each device intercepts the fieldbus and can send messages whenever the fieldbus is free. If two devices start an access at the same time, the device with the highest priority, i.e., the lowest identifier, is assigned the access right. Devices with a lower priority interrupt the data transfer and make a further access attempt once the fieldbus becomes free.

Any device can receive the messages. An acceptance filter ensures that messages are received only by the intended devices. Data is transferred via message telegrams. Message telegrams consist of a COB ID (Communication Object Identifier) and a maximum of 8 subsequent bytes. The COB ID dictates the priority of the messages. The COB ID is made up of the function code and the node number.

The function code describes the message type:

- **Message with service data (SDO)**

For parameterization of object directory entries

- Any length
- Cyclical transmission
- SDOs of a device are combined in the object directory
- Mailbox is placed on a (server) SDO, 36 bytes long

- **Message with process data (PDO)**

For transmitting real-time data

- Maximum 8 bytes long
- Cyclical or event-controlled transmission
- Distinction between send (max. 512) and receive PDOs (max. 512)
- In the CAN, PDOs occupy their own identifier

- **Messages for network management (NMT)**

For controlling the finite state machine of the CANopen device and for monitoring the nodes

- Further objects such as synchronization object (SYNC), time stamp and error messages (EMCY).

The most important attributes of the process data objects (PDOs) and service data objects (SDOs) are shown in the table below.

Process data objects (PDOs)	Service data objects (SDOs)
Are used for real-time data exchange	Permit access to the object directory; each SDO assembles a point-to-point service communication channel.
Typically messages with high priority	Messages with lower priority
Synchronous and asynchronous data transfer	Typically asynchronous data transfer
Cyclical and noncyclical transmission	Typically noncyclical transmission
Data of the PDOs can be configured via SDOs	Use of the data field is dictated by the CMS (CAN Message Specification) Multiplexed Domain Protocol.
Preformatted data field	Access to an entry in the device object directory via index and subindex.

Additional Information

CAN in Automation (CiA)
International Users and Manufacturers Group e.V.
Kontumazgarten 3
90429 Nuremberg, Germany

<http://www.can-cia.org/>

- CiA Draft Standard V4.02
- CiA Draft Standard 303 LED-Behavior

5.1.2 Basic Technical Information about CANopen

Connecting the Bus System

Within the CANopen network, all devices communicate via a 2-pin network cable. All devices are then connected with the cable in parallel. To prevent interfering reflections within a network, you must connect a suitable terminator to each end. For details of suitable cables and terminators, see chapter 2.3.

Device Profile

CANopen defines various device profiles for numerous device types. At present, reader PGV*-F200*-B16-V15 does not correspond to any special device profile. The "Generic Device" profile is therefore assigned to the reader.

Bus Length

The maximum line length within a CANopen network is dictated by the signal runtime. Communication within the network requires that signals are present on all bus nodes at the same time. The network can be adapted to the existing line lengths through various baud rates. The values in the table below serve as a reference point. The actual values may differ, depending on the applications concerned.

Baud rate [kBit/s]	Max. bus length [m]
1000	30
500	100
250	250
125	500
50	1000

For information on setting the baud rate for the reader, see chapter 4.3.

Shielding

Ensure continuous shielding when cabling the reader. For details of the suitable fieldbus cables, see chapter 2.3.

Startup Behavior

After switch-on, the reader in a CANopen network passes through several operating states.

1. Initialization

Startup process of the reader.

2. Preoperational

Reader state on completion of the startup process. The reader reports this state to the NMT master.

3. Operational

Operative state of the reader. The NMT master sets this state via an NMT start node telegram once it has received the preoperational message from the reader.

Exchange of Process Data

Within the CANopen network, process data is exchanged via Process Data Objects (PDO). See chapter 5.1.1. Process data objects are divided into:

■ Transmit PDOs (TxPDO)

Process data objects that transmit input data and diagnostic data.

■ Receive PDOs (RxPDO)

Process data objects that transmit output data.

The first 4 PDOs per transmit or receive data packet transmit the default CAN identifier. All other PDOs of a data packet can be configured by the user.

Communication Types

In the CANopen network, various communication types are specified for process data objects. The communication type of each PDO is controlled via the "Transmission Type" parameter. The "Transmission Type" parameter is defined in subindex 2 of the communication parameter object (from 0x1400) and is transmitted during the startup process via an SDO. See chapter 5.1.1.

The reader supports the following communication types:

"Transmission Type" parameter	Transmission	Description
0	Event-controlled Synchronous	TxPDO: Data is detected upon receipt of a SYNC (= s ynchronization object). Data is transmitted only in the event of a change. RxPDO: Data is sent in an event-controlled manner and adopted in a SYNC.
1	Cyclic Synchronous	Data is adopted and transmitted cyclically at each nth SYNC. n = 1 ... 240. n can be individually assigned for each PDO to control transmission cycles.
241 ... 251	Reserved	
252 (TxPDO only)	Synchronous RTR (= remote transmission request)	Data is detected upon receipt of a SYNC. Data is sent via RTR only on request.
253 (TxPDO only)	Asynchronous RTR	Data is detected and sent via RTR only on request.

2016-09

"Transmission Type" parameter	Transmission	Description
254	Event-controlled Manufacturer-specific	Reader sends data when "Operational" state is set and in the event of changes.
255	Event-controlled Profile-specific	Reader sends data when "Operational" state is set and in the event of changes.

Communication Monitoring

To monitor bus communication, you can configure the following process in the reader.

■ Node guarding

If you have configured the reader for node guarding, the NMT master sends guard telegrams that have to be answered by the reader with the current CANopen status. The gap between the guard telegrams is defined in object 0x100C. See chapter 5.1.3.

If the reader does not send a response, a "Node Guard Event" is set. Node guarding is deactivated when you set the "Guard Time" in object 0x100C to 0.

■ Lifeguarding

If you have configured the reader for lifeguarding, the reader sends lifeguard telegrams that have to be answered by the NMT master. The gap between a lifeguard telegram and the response from the NMT master is defined in object 0x100D. See chapter 5.1.3.

If the guard telegram remains unanswered for the defined time, the reader sets a "Lifeguarding Event" and sends an EMCY telegram. Lifeguarding is deactivated when you set the "Guard Time" in object 0x100C or the "Life Time Factor" in object 0x100D to 0.

■ Heartbeat

The reader can be configured both as emitter and receiver of a heartbeat telegram. If the reader is configured for sending a heartbeat telegram, this telegram will be monitored by the NMT master or a different bus node. If the reader is configured for receiving a heartbeat telegram, the reader monitors a different bus node or the NMT master.

Configure heartbeat telegram transmission in object 0x1017. Specify the gap between the heartbeat telegrams via the "Heartbeat Producer Time". The heartbeat is deactivated when the "Heartbeat Producer Time" is set to 0.

Configure heartbeat telegram receipt in object 0x1016. Specify the gap between the heartbeat telegrams via the "Heartbeat Consumer Time". The heartbeat is deactivated when the "Heartbeat Consumer Time" is set to 0.

Failsafe

Failsafe is the behavior of the reader when errors occur. The failsafe behavior is controlled via a parameter.

The behavior of the reader in the event of a CANopen error can be controlled via object 0x1029 "Behavior in the event of an error". For a detailed description, see chapter 5.1.3.

5.1.3 CANopen Object Directory



Note!

CANopen Parameter Communication

This section contains the information required for the data exchange via CANopen. Data is exchanged with the reader via objects. These objects and their respective permissible functions are defined in the following SDO directory.

The reader supports the identifier format 2.0A (11-bit identifier) according to the CAN specification. The extended 29-bit identifier is not supported.

Supported Objects

Object	Description
0x1000	Device Type
0x1001	Error Register
0x1008	Manufacturer Device Name
0x1009	Manufacturer Hardware Version
0x100A	Manufacturer Software Version
0x100C	Guard Time
0x100D	Life Time Factor
0x1014	Emergency ID
0x1015	Emergency Inhibit Time
0x1016	Consumer Heartbeat Time
0x1017	Producer Heartbeat Time
0x1018	Identity Object
0x1029	Error Behavior
0x1200	1. Server SDO parameter (default SDO)
0x1400	Receive PDO 1 parameter
...	...
0x1403	Receive PDO 4 parameter
0x1600	Receive PDO 1 mapping
...	...
0x1603	Receive PDO 4 mapping
0x1800	Send PDO 1 parameter
...	...
0x1804	Send PDO 5 parameter
0x1A00	Send PDO 1 mapping
...	...
0x1A04	Send PDO 5 mapping
0x2000	Position data and status data
0x3000	Serial Number
0x3001	Parameterization object

The device-specific object directory OV contains all parameters and process data for the reader. The parameters and process data are listed in tables. The object directory has two defined areas. In the first area, the reader is described in general terms. The device ID, the name of the manufacturer, and the communication parameters are listed here. In the second area, the specific functionality of the reader is described.

An entry in the object list is identified via a 16-bit index and an 8-bit subindex. Access to device parameters and process data, such as input signals and output signals, device functions, and network variables, is provided via the assignment within the object list in standardized form over the CANopen network.

Device Type

Index	Subindex	Description	Data type	Attribute	PDO mapping possible	Default value
0x1000	0	Device Type	unsigned32 ¹	ro (= read only)	no	0x00000000

Table 5.1 The device type of the reader is 0x00000000, since no specific device profile is implemented.

1.Data type without prefix, 32 bit

Error Register

Index	Subindex	Description	Data type	Attribute	PDO mapping possible	Default value
0x1001	0	Error Register	unsigned8	ro	no	0x00

The 8-bit data of the error register describes errors as follows:

Bit							
7	6	5	4	3	2	1	0
0	Reserved	Reserved	Communication errors	Reserved	Reserved	Reserved	Generic error not specified in more detail ¹

1.Flag is set for every error message

SYNC Identifier

Index	Subindex	Description	Data type	Attribute	PDO mapping possible	Default value
0x1005	0	COB-IDSYNC Message	unsigned32	rw (= read/write)	no	0x00000080

The 32-bit data of the identifier in the SYNC message describes the synchronization as follows:

Bit			
31	30	...	10 ... 0
Has no meaning	0 ¹	...	Identifier 0x80 = 128 _{dec}

1.Always 0, since reader is only for SYNC consumers, not SYNC producers

Device Name of Bus Node

Index	Subindex	Description	Data type	Attribute	PDO mapping possible	Default value
0x1008	0	Manufacturer Device Name	visible string ¹	ro	no	-

¹ ASCII string, variable length

Hardware Version Number of the Bus Node

Index	Subindex	Description	Data type	Attribute	PDO mapping possible	Default value
0x1009	0	Manufacturer Hardware Version	visible string	ro	no	-

Software Version Number of the Bus Node

Index	Subindex	Description	Data type	Attribute	PDO mapping possible	Default value
0x100A	0	Manufacturer Software Version	visible string	ro	no	-

Gap between Guard Telegrams

Index	Subindex	Description	Data type	Attribute	PDO mapping possible	Default value
0x100C	0	Guard Time [ms]	unsigned16	rw	no	0

Watchdog Master Monitoring

Index	Subindex	Description	Data type	Attribute	PDO mapping possible	Default value
0x100D	0	Life Time Factor	unsigned8	rw	no	0

Table 5.2 Life time factor x guard time = life time (watchdog for life guarding - master monitoring)

Identifier of the Emergency Telegram

Index	Subindex	Description	Data type	Attribute	PDO mapping possible	Default value
0x1014	0	COB-ID Emergency	unsigned32	ro	no	0x00000080 + Node ID

Consumer Heartbeat Time

Index	Subindex	Description	Data type	Attribute	PDO mapping possible	Default value
0x1016	0	Number of Subsequent Parameters	unsigned8	ro	no	40
	1 ... 64	Consumer Heartbeat Time ¹	unsigned32	rw	no	0

1.Expected heartbeat cycle time [ms] and node ID of the monitored bus node

The monitored identifier guard ID results from the default identifier distribution: Guard ID = 0x700 + node ID

Bit		
31 ... 24	23 ... 16	15 ... 0
Reserved ¹	Node ID	Heartbeat Time [ms]

1.Always 0

Producer Heartbeat Time

Index	Subindex	Description	Data type	Attribute	PDO mapping possible	Default value
0x1017	0	Producer Heartbeat Time ¹	unsigned16	rw	no	0

1.Time [ms] between two sent heartbeat telegrams

Identify Object

Index	Subindex	Description	Data type	Attribute	PDO mapping possible	Default value
0x1018	0	Number of Subsequent Parameters	unsigned8	ro	no	4
	1	Manufacturer Identifier	unsigned32	ro	no	0x000000AD
	2	Device Identifier	unsigned32	ro	no	0
	3	Version Number	unsigned32	ro	no	0
	4	Serial Number	unsigned32	ro	no	0

Behavior in the Event of an Error

Index	Subindex	Description	Data type	Attribute	PDO mapping possible	Default value
0x1029	0	Number of Subsequent Parameters	unsigned8	ro	no	1
	1	Consumer Heartbeat Time ¹	unsigned8	rw	no	0

1.For procedure in case of communication errors, see the table below

Data bit	Procedure in case of communication errors
0x00	Reader changes from Operational to Preoperational
0x01	Reader retains current status
0x02	Reader changes to Stopped

Communication Parameter 1 RxPDO

Index	Subindex	Description	Data type	Attribute	PDO mapping possible	Default value
0x1400	0	Number of Subsequent Parameters	unsigned8	ro	no	2
	1	COB ID	unsigned32	rw	no	0x00000200 + Node ID
	2	Transmission Type	unsigned8	rw	no	254

COB ID: Bit			
31	30	29 ... 11	10 ... 0
PDO present: 0 = currently present 1 = not present	RTR access: 0 = permitted 1 = not permitted	...	CAN identifier ¹

1.Cannot be changed when PDO is currently present

Communication Parameter 1 TxPDO

Index	Subindex	Description	Data type	Attribute	PDO mapping possible	Default value
0x1800	0	Number of Subsequent Parameters	unsigned8	ro	no	5
	1	COB ID	unsigned32	rw	no	0x00000180 + Node ID
	2	Transmission Type	unsigned8	rw	no	254
	3	Repeat delay [value x 100 µs]	unsigned16	rw	no	0
	4	Not used				
	5	Event Timer	unsigned16	rw	no	0

2016-09

COB ID: Bit			
31	30	29 ... 11	10 ... 0
PDO present: 0 = currently present 1 = not present	RTR access: 0 = permitted 1 = not permitted	...	CAN identifier ¹

1. Cannot be changed when PDO is currently present

Communication Parameter 2 TxPDO

Index	Subindex	Description	Data type	Attribute	PDO mapping possible	Default value
0x1801	0	Number of Subsequent Parameters	unsigned8	ro	no	5
	1	COB ID	unsigned32	rw	no	0x00000280 + Node ID
	2	Transmission Type	unsigned8	rw	no	254
	3	Repeat delay [value x 100 µs]	unsigned16	rw	no	0
	4	Not used				
	5	Event Timer	unsigned16	rw	no	0

COB ID: Bit			
31	30	29 ... 11	10 ... 0
PDO present: 0 = currently present 1 = not present	RTR access: 0 = permitted 1 = not permitted	...	CAN identifier ¹

1. Cannot be changed when PDO is currently present

Communication Parameter 3 TxPDO

Index	Subindex	Description	Data type	Attribute	PDO mapping possible	Default value
0x1802	0	Number of Subsequent Parameters	unsigned8	ro	no	5
	1	COB ID	unsigned32	rw	no	0x00000380 + Node ID
	2	Transmission Type	unsigned8	rw	no	254
	3	Repeat delay [value x 100 µs]	unsigned16	rw	no	0
	4	Not used				
	5	Event Timer	unsigned16	rw	no	0

COB ID: Bit			
31	30	29 ... 11	10 ... 0
PDO present: 0 = currently present 1 = not present	RTR access: 0 = permitted 1 = not permitted	...	CAN identifier ¹

1. Cannot be changed when PDO is currently present

Communication Parameter 4 TxPDO

Index	Subindex	Description	Data type	Attribute	PDO mapping possible	Default value
0x1803	0	Number of Subsequent Parameters	unsigned8	ro	no	5
	1	COB ID	unsigned32	rw	no	0x00000480 + Node ID
	2	Transmission Type	unsigned8	rw	no	254
	3	Repeat delay [value x 100 µs]	unsigned16	rw	no	0
	4	Not used				
	5	Event Timer	unsigned16	rw	no	0

COB ID: Bit			
31	30	29 ... 11	10 ... 0
PDO present: 0 = currently present 1 = not present	RTR access: 0 = permitted 1 = not permitted	...	CAN identifier ¹

1. Cannot be changed when PDO is currently present

Communication Parameter 5 TxPDO

Index	Subindex	Description	Data type	Attribute	PDO mapping possible	Default value
0x1804	0	Number of Subsequent Parameters	unsigned8	ro	no	5
	1	COB ID	unsigned32	rw	no	0x80000000
	2	Transmission Type	unsigned8	rw	no	254
	3	Repeat delay [value x 100 µs]	unsigned16	rw	no	0
	4	Not used				
	5	Event Timer	unsigned16	rw	no	0

COB ID: Bit			
31	30	29 ... 11	10 ... 0
PDO present: 0 = currently present 1 = not present	RTR access: 0 = permitted 1 = not permitted	...	CAN identifier ¹

1. Cannot be changed when PDO is currently present

Mapping 1 RxPDO

Index	Subindex	Description	Data type	Attribute	PDO mapping possible	Default value	Meaning ¹
0x1600	0	Number of Subsequent Parameters	unsigned8	rw	no	8	Number of mapped objects
	1	1. Mapped Object	unsigned32	rw	no	0x22000108	Input Data MSB Data = 0x2200, byte 1
	2	2. Mapped Object	unsigned32	rw	no	0x22000208	Reserved
	3	3. Mapped Object	unsigned32	rw	no	0x22000308	Reserved
	4	4. Mapped Object	unsigned32	rw	no	0x22000408	Reserved
	5	5. Mapped Object	unsigned32	rw	no	0x22000508	Reserved
	6	6. Mapped Object	unsigned32	rw	no	0x22000608	Reserved
	7	7. Mapped Object	unsigned32	rw	no	0x22000708	Reserved
	8	8. Mapped Object	unsigned32	rw	no	0x22000808	Reserved

1. Application objects: 2-byte index, 1-byte subindex, 1-byte number of bits

Mapping 1 TxPDO

Index	Subindex	Description	Data type	Attribute	PDO mapping possible	Default value	Meaning ¹
0x1A00	0	Number of Subsequent Parameters	unsigned8	rw	no	8	Number of mapped objects
	1	1. Mapped Object	unsigned32	rw	no	0x20000108	Y position data YP24-YP31 MSB Data = 0x2000, byte 1 1. Bit = sign bit
	2	2. Mapped Object	unsigned32	rw	no	0x20000208	Y position data YP16-YP23 MSB Data = 0x2000, byte 2 1. Bit = sign bit
	3	3. Mapped Object	unsigned32	rw	no	0x20000308	Y position data YP08-YP15 MSB Data = 0x2000, byte 3 1. Bit = sign bit
	4	4. Mapped Object	unsigned32	rw	no	0x20000408	Y position data YP00-YP07 LSB Data = 0x2000, byte 4 1. Bit = sign bit
	5	5. Mapped Object	unsigned32	rw	no	0x20000508	Reserved
	6	6. Mapped Object	unsigned32	rw	no	0x20000608	Reserved
	7	7. Mapped Object	unsigned32	rw	no	0x20000708	Reserved
	8	8. Mapped Object	unsigned32	rw	no	0x20000808	Reserved

¹ Application objects: 2-byte index, 1-byte subindex, 1-byte number of bits

Mapping 2 TxPDO

Index	Subindex	Description	Data type	Attribute	PDO mapping possible	Default value	Meaning ¹
0x1A01	0	Number of Subsequent Parameters	unsigned8	rw	no	8	Number of mapped objects
	1	1. Mapped Object	unsigned32	rw	no	0x20000908	X position data XP24-XP31 MSB Data = 0x2000, byte 9
	2	2. Mapped Object	unsigned32	rw	no	0x20000A08	X position data XP16-XP23 MSB Data = 0x2000, byte 10
	3	3. Mapped Object	unsigned32	rw	no	0x20000B08	X position data XP08-XP15 MSB Data = 0x2000, byte 11
	4	4. Mapped Object	unsigned32	rw	no	0x20000C08	X position data XP00-XP07 LSB Data = 0x2000, byte 12
	5	5. Mapped Object	unsigned32	rw	no	0x20000D08	Angle AG08-AG15 MSB Data = 0x2000, byte 13
	6	6. Mapped Object	unsigned32	rw	no	0x20000E08	Angle AG00-AG07 LSB Data = 0x2000, byte 14
	7	7. Mapped Object	unsigned32	rw	no	0x20000F08	Reserved
	8	8. Mapped Object	unsigned32	rw	no	0x20001008	Reserved

1. Application objects: 2-byte index, 1-byte subindex, 1-byte number of bits

Mapping 3 TxPDO

Index	Subindex	Description	Data type	Attribute	PDO mapping possible	Default value	Meaning ¹
0x1A02	0	Number of Subsequent Parameters	unsigned8	rw	no	8	Number of mapped objects
	1	1. Mapped Object	unsigned32	rw	no	0x20001108	Status ST08-ST15 MSB Data = 0x2000, byte 17
	2	2. Mapped Object	unsigned32	rw	no	0x20001208	Status ST00-ST07 MSB Data = 0x2000, byte 18
	3	3. Mapped Object	unsigned32	rw	no	0x20001308	Warning WRN08-WRN15 MSB Data = 0x2000, byte 19
	4	4. Mapped Object	unsigned32	rw	no	0x20001408	Warning WRN00-WRN07 LSB Data = 0x2000, byte 20
	5	5. Mapped Object	unsigned32	rw	no	0x20001508	Data Matrix tag TAG24-TAG31 MSB Data = 0x2000, byte 21
	6	6. Mapped Object	unsigned32	rw	no	0x20001608	Data Matrix tag TAG16-TAG23 MSB Data = 0x2000, byte 22
	7	7. Mapped Object	unsigned32	rw	no	0x20001708	Data Matrix tag TAG08-TAG15 MSB Data = 0x2000, byte 23
	8	8. Mapped Object	unsigned32	rw	no	0x20001808	Data Matrix tag TAG00-TAG07 MSB Data = 0x2000, byte 24

¹ Application objects: 2-byte index, 1-byte subindex, 1-byte number of bits

Mapping 4 TxPDO

Index	Subindex	Description	Data type	Attribute	PDO mapping possible	Default value	Meaning ¹
0x1A03	0	Number of Subsequent Parameters	unsigned8	rw	no	8	Number of mapped objects
	1	1. Mapped Object	unsigned32	rw	no	0x20001908	Status control code STCC1_00- STCC1_07 MSB Data = 0x2000, byte 25
	2	2. Mapped Object	unsigned32	rw	no	0x20001A08	Control code CC1_08- CC1_15 MSB Data = 0x2000, byte 26
	3	3. Mapped Object	unsigned32	rw	no	0x20001B08	Control code CC1_00- CC1_07 LSB Data = 0x2000, byte 27
	4	4. Mapped Object	unsigned32	rw	no	0x20001C08	Reserved
	5	5. Mapped Object	unsigned32	rw	no	0x20001D08	Reserved
	6	6. Mapped Object	unsigned32	rw	no	0x20001E08	Reserved
	7	7. Mapped Object	unsigned32	rw	no	0x20001F08	Reserved
	8	8. Mapped Object	unsigned32	rw	no	0x20002008	Reserved

1. Application objects: 2-byte index, 1-byte subindex, 1-byte number of bits

Mapping 5 TxPDO

Index	Subindex	Description	Data type	Attribute	PDO mapping possible	Default value	Meaning ¹
0x1A04	0	Number of Subsequent Parameters	unsigned8	rw	no	8	Number of mapped objects
	1	1. Mapped Object	unsigned32	rw	no	0x20002108	Z distance data Z08-Z15 MSB
	2	2. Mapped Object	unsigned32	rw	no	0x20002208	Z distance data Z00-Z07 LSB
	3	3. Mapped Object	unsigned32	rw	no	0x20002308	Reserved
	4	4. Mapped Object	unsigned32	rw	no	0x20002408	Reserved
	5	5. Mapped Object	unsigned32	rw	no	0x20002508	Reserved
	6	6. Mapped Object	unsigned32	rw	no	0x20002608	Reserved
	7	7. Mapped Object	unsigned32	rw	no	0x20002708	Reserved
	8	8. Mapped Object	unsigned32	rw	no	0x20002808	Reserved

¹ Application objects: 2-byte index, 1-byte subindex, 1-byte number of bits

Index	Subindex	7	6	5	4	3	2	1	0	
0x2000	1	YP31	YP30	YP29	YP28	YP27	YP26	YP25	YP24	
	2	YP23	YP22	YP21	YP20	YP19	YP18	YP17	YP16	
	3	YP15	YP14	YP13	YP12	YP11	YP10	YP09	YP08	
	4	YP07	YP06	YP05	YP04	YP03	YP02	YP01	YP00	
	5	Not defined								
	6	Not defined								
	7	Not defined								
	8	Not defined								
	9	XP31	XP30	XP29	XP28	XP27	XP26	XP25	XP24	
	10	XP23	XP22	XP21	XP20	XP19	XP18	XP17	XP16	
	11	XP15	XP14	XP13	XP12	XP11	XP10	XP09	XP08	
	12	XP07	XP06	XP05	XP04	XP03	XP02	XP01	XP00	
	13	AG15	AG14	AG13	AG12	AG11	AG10	AG09	AG08	
	14	AG07	AG06	AG05	AG04	AG03	AG02	AG01	AG00	
	15	Not defined								
	16	Not defined								
	17	0	0	0	0	TAG ¹	LC1	LC0	RP	
	18	NL	LL	RL	0	CC1	WRN	NP	ERR	
	19	WRN15	WRN14	WRN13	WRN12	WRN11	WRN10	WRN09	WRN08	
	20	WRN07	WRN06	WRN05	WRN04	WRN03	WRN02	WRN01	WRN00	
	21	TAG_31	TAG_30	TAG_29	TAG_28	TAG_27	TAG_26	TAG_25	TAG_24	
	22	TAG_23	TAG_22	TAG_21	TAG_20	TAG_19	TAG_18	TAG_17	TAG_16	
	23	TAG_15	TAG_14	TAG_13	TAG_12	TAG_11	TAG_10	TAG_09	TAG_08	
	24	TAG_07	TAG_06	TAG_05	TAG_04	TAG_03	TAG_02	TAG_01	TAG_00	
	25	Not defined					O1_1	O1_0	S1_1	S1_0
	26	CC1_15	CC1_14	CC1_13	CC1_12	CC1_11	CC1_10	CC1_09	CC1_08	
	27	CC1_07	CC1_06	CC1_05	CC1_04	CC1_03	CC1_02	CC1_01	CC1_00	
	28	Not defined								
	29	Not defined								
	30	Not defined								
	31	0x00								
	32	0x00								
	33	Z15	Z14	Z13	Z12	Z11	Z10	Z09	Z08	
	34	Z07	Z06	Z05	Z04	Z03	Z02	Z01	Z00	
	35	0x00								
	36	0x00								
	37	0x00								
	38	0x00								
	39	0x00								
	40	0x00								

1.If bit = 1: reader detects Data Matrix tag

Index	Subindex	7	6	5	4	3	2	1	0
0x2200	0	Number of Subsequent Parameters							
	1	0	0	0	I_Ctrl 1	0	0	Input_Dir_ Sel_Right	Input_Dir_ Sel_Left
	2	0x00							
	3	0x00							
	4	0x00							
	5	0x00							
	6	0x00							
	7	0x00							
	8	0x00							

1. Lighting control:
0 = lighting on
1 = lighting off

Description	Function
ANG	Absolute angle specification
CC1_#/CC2_#	Control code 1 or 2 with number # detected Control code 2 is evaluated via the "Split value" function. ¹
CC1/CC2	Associated control code is detected.
ERR	Error message Error codes are stored in XP00 ... XP23. Additional information on the codes can be found in the Error Codes table.
LC	Number of lanes in the reading window. Refer to section " Number of Lanes LC "
LL/RL	Selected direction decision
NL	No colored lane detected
NP	No absolute X position
O1_#/O2_#	Orientation control code for lane. Refer to section " Orientation O "
RP	Repair tape detected
S1_#/S2_#	Relative position control code for lane. Refer to section " Side S "
TAG	Data Matrix tag detected
TAG_#	Data Matrix tag with number # detected
WRN	Warning message Warnings are stored in WRN00 ... WRN13. Additional information on the codes can be found in the Warning Messages table.
XP	Absolute position in the X direction, unsigned
XPS	Absolute position in the X direction, signed
YPS	Absolute position in the Y direction, signed

Table 5.3

1. Should you have any questions, please contact Pepperl+Fuchs

Error Codes

Error code	Description	Priority
2	No clear position can be determined, e.g., difference between codes is too great, code distance incorrect	4
5	No direction decision available	2
> 1000	Internal fault	1

Warning Messages

Warning code	Warning message	Description	Priority
WRN00	1	A code with non-PGV content was found.	3
WRN01	2	Reader too close to code tape	4
WRN02	3	Reader too far from code tape	5
WRN03	4	Y position too large. The sensor is just before OUT	6
WRN04	5	Y position too small. The sensor is just before OUT	7
WRN05	6	The reader is rotated or tilted in relation to the code tape	8
WRN06	7	Low level of code contrast	9
WRN07	8	Repair tape detected	1
WRN08	9	Temperature too high	2
WRN09	10	Position code near branch/crossover detected	10
WRN10	11	More than the specified number of code lanes present	11
WRN11	12	Reserved	-
WRN12	13	Reserved	-
WRN13	14	Reserved	-
WRN14	15	Reserved	-
WRN15	16	Reserved	-

Table 5.4 If no warning messages are present, all bits in the warning data set are set to 0.

Serial Number

Index	Subindex	Description	Data type	Attribute	PDO mapping possible	Value
0x3000	0	Serial Number	ASCII string	ro	no	Serial number

Number of Lanes LC (Lane Count)

The lane count, LC, indicates the number of found fab or Data Matrix tracks in the reading window. A variety of causes may be responsible if the lane count does not match the expected number of lanes:

LC < actual number

- Lane is not located in the reading window
- Color of the lane does not match the configured color

LC > actual number

- Contrast between the ribbon and the floor is too low



Tip

Increase contrast

To ensure maximum contrast between the floor and the ribbon, please note the following contrast colors:

Basic color green: contrast color red

Basic color blue: contrast color red

Basic color red: contrast color green

Meaning of Bits

LC1	LC0	Meaning
0	0	No lane found
0	1	1 lane found
1	0	2 lanes found
1	1	3 or more lanes found

Orientation O

The orientation O indicates the orientation of the control codes in the reading window.

Meaning of Bits

O1	O0	Meaning
0	0	Control code has the same orientation as ascending Data Matrix lane
0	1	Orientation of control code rotated 90° clockwise in relation to ascending Data Matrix lane
1	0	Orientation of control code rotated 180° clockwise in relation to ascending Data Matrix lane
1	1	Orientation of control code rotated 270° clockwise in relation to ascending Data Matrix lane

Orientation

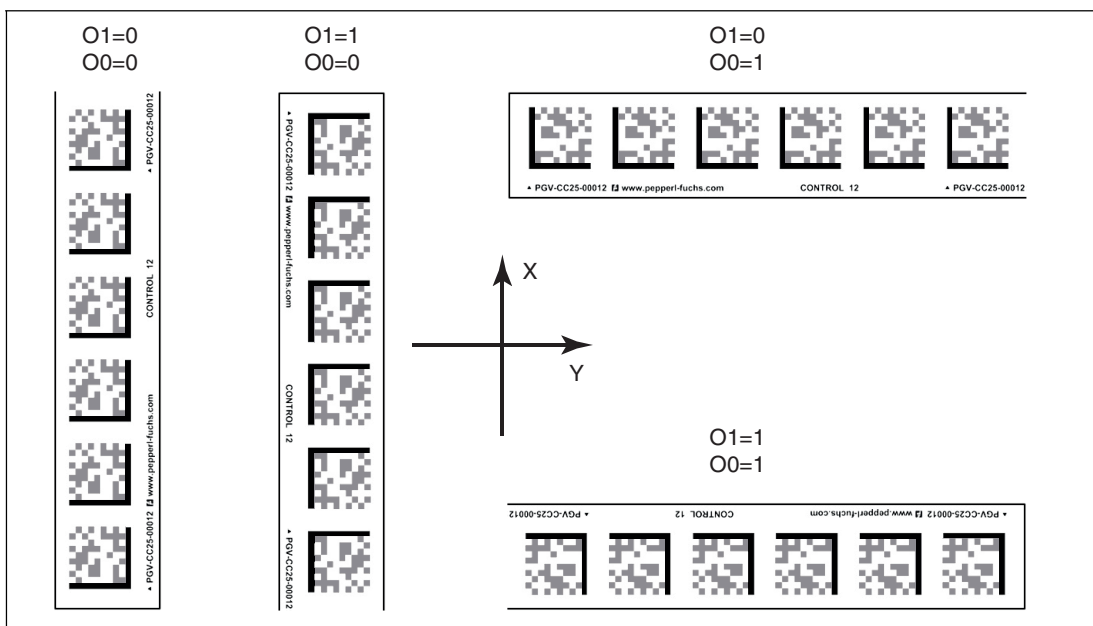

Figure 5.2

2016-09

Side S

Side S specifies the side of the Data Matrix lane on which the control codes are present.

Meaning of Bits

S1	S0	Meaning
0	0	No control code is present or found Reserved
0	1	Control code to the right of the Data Matrix or color lane
1	0	Control code to the left of the Data Matrix or color lane
1	1	Not detectable ¹

1. Control code laid on Data Matrix lane

No Data Matrix lane

Example

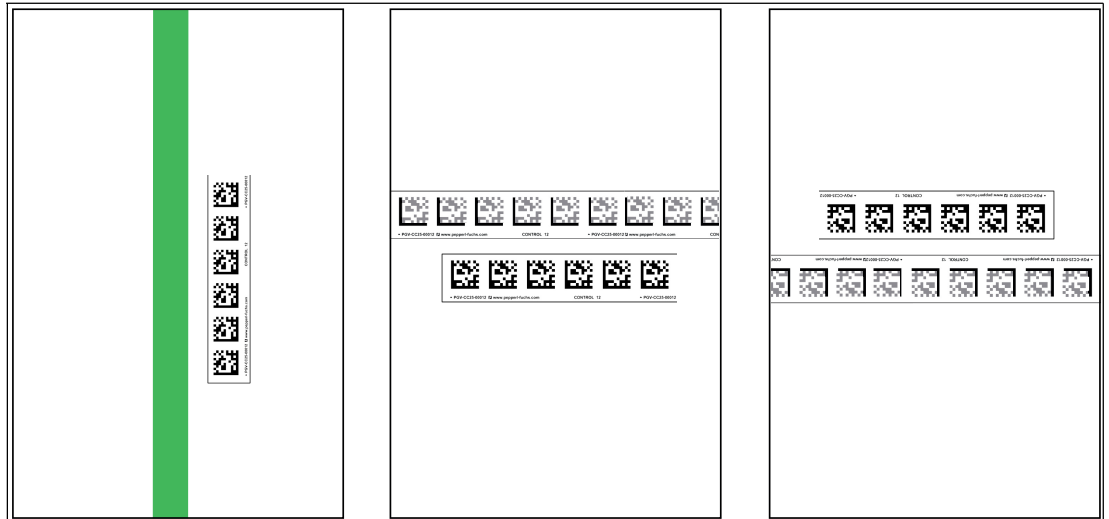

Figure 5.3 Control code to the **right** of the Data Matrix or color lane

Position/Lane

You can use the following table to draw conclusions on the current section in the reading window from the feedback of the read head regarding Data Matrix **TAG**, No Lane **NL**, No X Position **NP**, absolute X position **XP** and the Y position and angle **YPS/ANG**.

Meaning of Bits

TAG	NL	NP	XP	YPS/ANG	Meaning
0	0	0	+ ¹	+	Color and Data Matrix lane present. Position and angle refer to the Data Matrix lane.
0	0	1	_ ²	+	Color lane available.
0	1	0	+	+	Data Matrix lane.
0	1	1	-	-	No evaluable objects exist.
1	-	0	+	+	Position on the basis of a Data Matrix tag, X position is signed.

1. Valid data present

2. No valid data available

5.1.4 Object 3001

Global primary data allows you to parameterize the reader using CANopen. Global primary data is always transferred to the reader in full.

Subindex	Designation	Function	Parameter data	Data type	Primary data
0	Number of subsequent parameters			unsigned8	11
1	X resolution	Multiplier for the length in the direction of the X coordinate	Resolution	unsigned32	0.1 mm 1 mm 10 mm
2	Y resolution	Multiplier for the length in the direction of the Y coordinate	Resolution	unsigned32	0.1 mm 1 mm 10 mm
3	Angle Resolution	Multiplier for the angle output	Resolution	signed32	-16384 – 16384 360
4	Horizontal Offset	Offset in the direction of the X coordinate	Length	signed32	0 mm – ±10,000,000 mm
5	Vertical Offset	Offset in the direction of the Y coordinate	Length	signed32	0 mm – ±10,000,000 mm
6	Angle Offset	Line of vision offset	Angle	signed32	-16383 – 0 – 16383

Subindex	Designation	Function	Parameter data	Data type	Primary data
7	No Position Value X	X value if no code tape is visible	X data at "No Position"	octet_string Octet 0-3	Last Valid Position (0) Specified Value (1)
	No Position Specific X Position	Specific X value		Octet 4-7	-2147483648 – 0 – 2147483647
8	No Position Value Y	Y value if no code tape is visible	Y data at "No Position"	octet_string Octet 0-3	Last Valid Position (0) Specified Value (1)
	No Position Specific Y Position	Specific Y value		Octet 4-7	-32768 – 0 – 32767
9	No Position Value Angle	Angle output if no colored tape is visible	Angle data at "No Position"	octet_string Octet 0-3	Last Valid Angle (0) Specified Angle (1)
	No Position Specific Angle Position	Fixed angle		Octet 4-7	0 – 65535
10	Bandwidth	Width of the colored tape	Width	unsigned32	10 mm – 100 mm 18 mm
11	Color	Color of the tape	Color	unsigned32	1 = blue (RAL 5015) 2 = green (RAL 6032) 4 = red (RAL 3001) 8 = yellow (RAL 1021)
12	Input Source Selection	Selecting the source of the input data	Selection	unsigned32	0 = hardware input 1 = software (PDO)

Table 5.5 **Bold** = default values

5.2 Operation Using Control Codes

In numerous positioning system applications, defined processes (= event) must be started at specific positions. This means that the exact positions must be defined via code tapes for positioning, instead of simple colored tapes. In the context of lane tracking, it is advisable to mark branches using control codes to facilitate the control of the direction decision.

The layout of the lane can be adjusted according to the application in question. If an automated guided vehicle must be positioned exactly, a code tape is mounted for positioning purposes instead of the colored tape. If an event needs to start at a particular position or a direction decision needs to be made, a control code is mounted parallel to the actual lane.

Only a specific event and the associated process then have to be programmed into the system controller. The position in which the corresponding control code is placed next to the colored tape or code tape for positioning does not have to be determined until final commissioning. Even if subsequent changes are made to the layout of a system, the relevant control code is simply moved to the new position without requiring program modifications to be made.

Control codes are short code tapes one meter in length. The control code has an encrypted number. Control codes exist with numbers ranging from 001 to 999.

When the read head enters the range of a control code, it sets the control code flag in its output data.

The 1-meter-long control code can be shortened. However, the minimum length should be 3 codes (60 mm). If the speed of the read head increases, a longer control code is required. If the read head travels at maximum speed, a full-length control code of 1 meter must be positioned next to the colored tape or code tape for positioning.

The minimum length of a control code can be calculated according to the following formula depending on the travel speed and trigger period:

$$L_{\text{control code}} = 60 \text{ mm} + V_{\text{max}} [\text{m/s}] * T_{\text{Trigger}} [\text{s}] * 2$$

The trigger period is 40 ms.



Example!

Example calculation

The minimum length of the control code at a speed of 3 m/s and a trigger period of 40 ms is:

$$L_{\text{Event marker}} = 60 \text{ mm} + 3 \text{ m/s} * 40 \text{ ms} * 2 = \mathbf{300 \text{ mm}}$$

Control codes are identified by the printed number, in this case "Control 12".

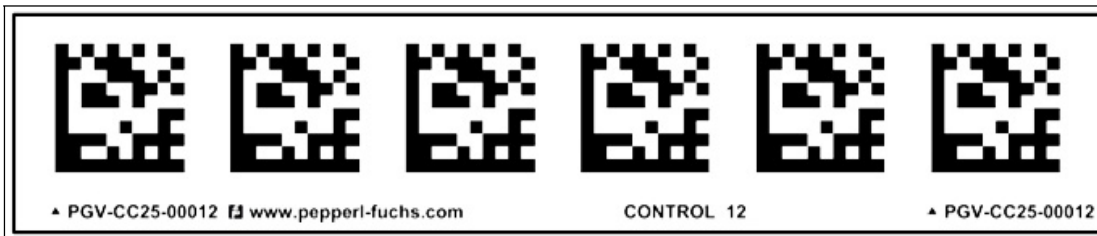

Figure 5.4 PGV-CC25-0012

The illustration shows part of control code #12

Refer to the "Accessories" chapter for order information relating to control codes.

5.3 Operation Using Repair Tape

The repair tape is a short code tape one meter in length. The repair tape is used to bridge defective or damaged areas of an existing code tape.

1. Cut the repair tape to the required length
2. Cover the defective area of the existing code tape with the repair tape



Note!

When placing a repair tape on the code tape, make sure that the repair tape continues the pattern on the code tape as accurately as possible.

When the read head enters the range of a repair tape, it sets the repair tape flag in its output data.



Note!

The repair tape works incrementally. In so doing, it adds one value to the previous read position on the code tape. If the read head starts on a repair tape, the read head reports an error. Move the read head to a position on the code tape away from the repair tape to read the absolute value.



Tip

If repairs are required, the **Code Tape Generator** at www.pepperl-fuchs.com can be used as a short-term workaround. This generator enables segments of code tape to be produced and printed out online.

Enter the start value in meters and the code tape length of the section to be replaced in meters. This produces a printable PDF file containing the required segment of the code tape.

The printout must be used only as an emergency solution. The durability of the paper strip is extremely limited depending on the application!

Refer to the "Accessories" chapter for order information relating to repair tape.

6 Appendix

6.1 ASCII table

hex	dec	ASCII	hex	dec	ASCII	hex	dec	ASCII	hex	dec	ASCII
00	0	NUL	20	32	Space	40	64	@	60	96	'
01	1	SOH	21	33	!	41	65	A	61	97	a
02	2	STX	22	34	"	42	66	B	62	98	b
03	3	ETX	23	35	#	43	67	C	63	99	c
04	4	EOT	24	36	\$	44	68	D	64	100	d
05	5	ENQ	25	37	%	45	69	E	65	101	e
06	6	ACK	26	38	&	46	70	F	66	102	f
07	7	BEL	27	39	'	47	71	G	67	103	g
08	8	BS	28	40	(48	72	H	68	104	h
09	9	HT	29	41)	49	73	I	69	105	i
0A	10	LF	2A	42	*	4A	74	J	6A	106	j
0B	11	VT	2B	43	+	4B	75	K	6B	107	k
0C	12	FF	2C	44	,	4C	76	L	6C	108	l
0D	13	CR	2D	45	-	4D	77	M	6D	109	m
0E	14	SO	2E	46	.	4E	78	N	6E	110	n
0F	15	SI	2F	47	/	4F	79	O	6F	111	o
10	16	DLE	30	48	0	50	80	P	70	112	p
11	17	DC1	31	49	1	51	81	Q	71	113	q
12	18	DC2	32	50	2	52	82	R	72	114	r
13	19	DC3	33	51	3	53	83	S	73	115	s
14	20	DC4	34	52	4	54	84	T	74	116	t
15	21	NAK	35	53	5	55	85	U	75	117	u
16	22	SYN	36	54	6	56	86	V	76	118	v
17	23	ETB	37	55	7	57	87	W	77	119	w
18	24	CAN	38	56	8	58	88	X	78	120	x
19	25	EM	39	57	9	59	89	Y	79	121	y
1A	26	SUB	3A	58	:	5A	90	Z	7A	122	z
1B	27	ESC	3B	59	;	5B	91	[7B	123	{
1C	28	FS	3C	60	<	5C	92	\	7C	124	
1D	29	GS	3D	61	=	5D	93]	7D	125	}
1E	30	RS	3E	62	>	5E	94	^	7E	126	~
1F	31	US	3F	63	?	5F	95	_	7F	127	DEL

6.2 Code cards with special functions

The following code cards have special functions:

- ENABLE
- STORE
- CANCEL
- USE

■ DEFAULT

Enable

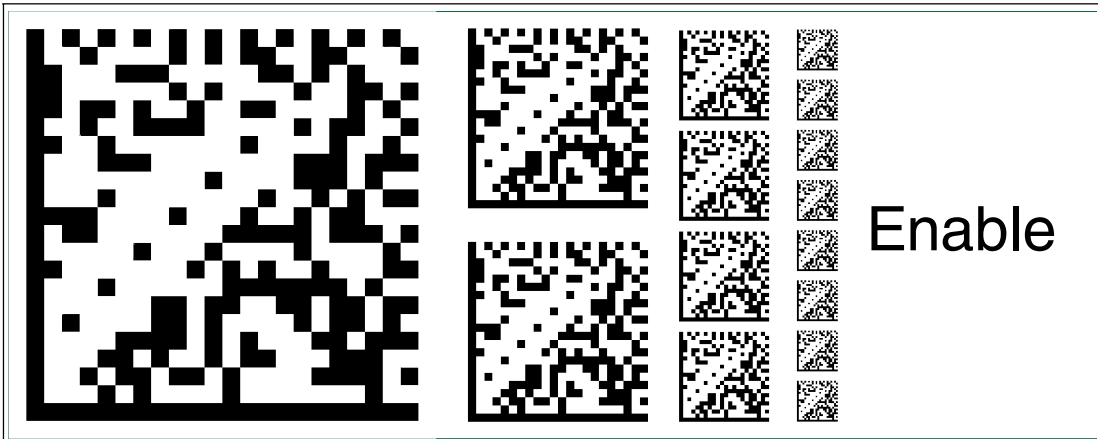

Figure 6.1 The code card "ENABLE" is used to activate external parameterization operating mode.

Store

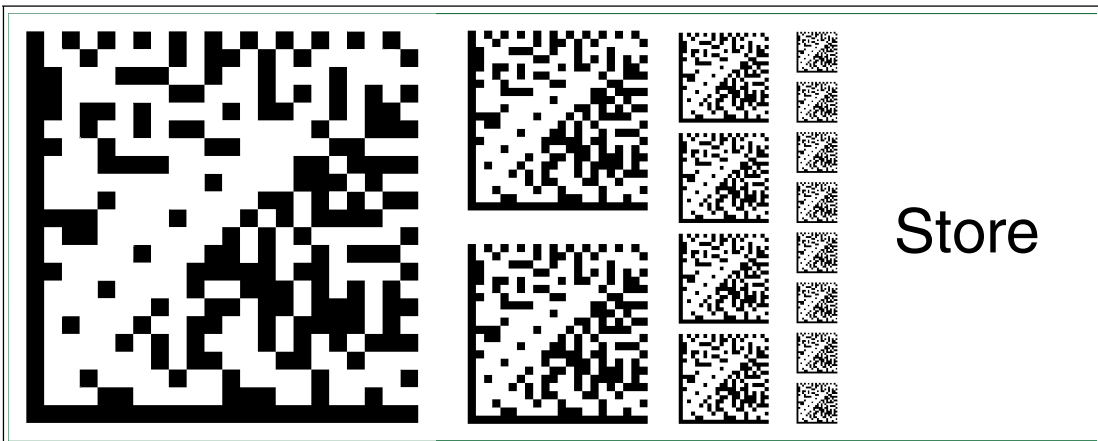

Figure 6.2 The code card "STORE" stores the modified parameterization in the non-volatile memory of the reading head and terminates external parameterization operating mode.

Cancel

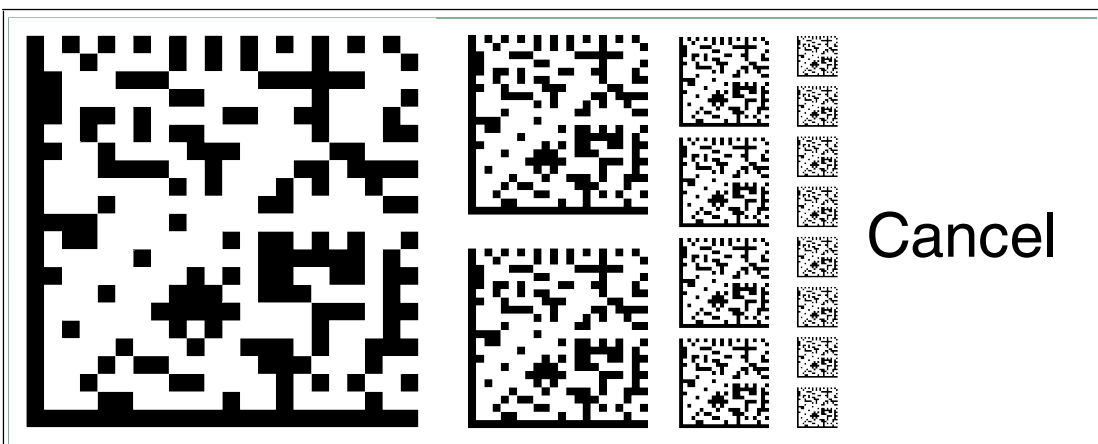

Figure 6.3 The code card "CANCEL" discards the modified parameterization and terminates external parameterization operating mode. The reading head switches to normal mode and adopts the last valid configuration that was saved.

2016-09

Use

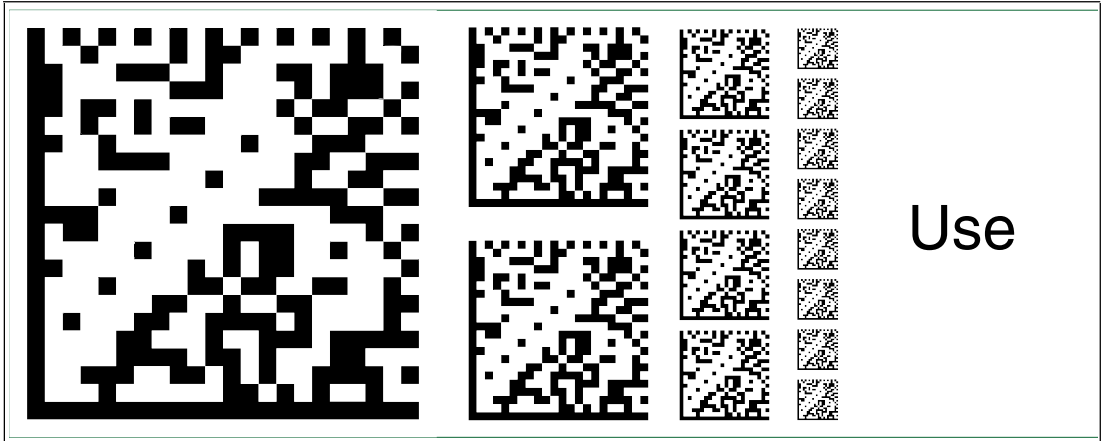

Figure 6.4 The code card "USE" adopts the modified configuration in the **volatile** working memory of the reading head and terminates external parameterization operating mode. The reading head then operates with this configuration. However, if the reading head is switched off and on again, the configuration is lost and the reading head operates with the last valid configuration that was saved. This function is used primarily for test purposes.

Default

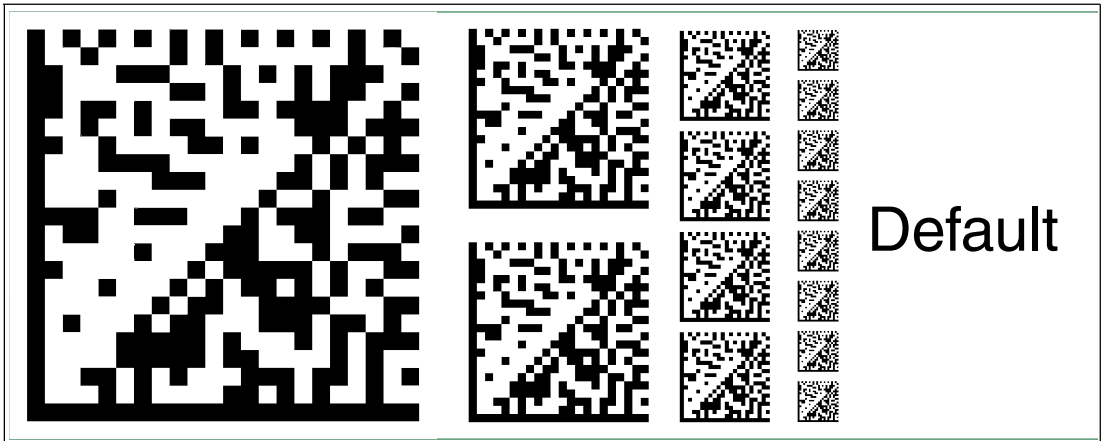

Figure 6.5 The code card "DEFAULT" restores the settings of the reading head to default and terminates external parameterization operating mode.

6.3 Code Cards for Setting the Baud Rate

Parameterization allows you to assign various transfer rates to the reader for communication via CANopen.

Baud Rate: 10 kBaud



Figure 6.6 The code card assigns the 10 kBaud baud rate to the read head

Baud Rate: 20 kBaud

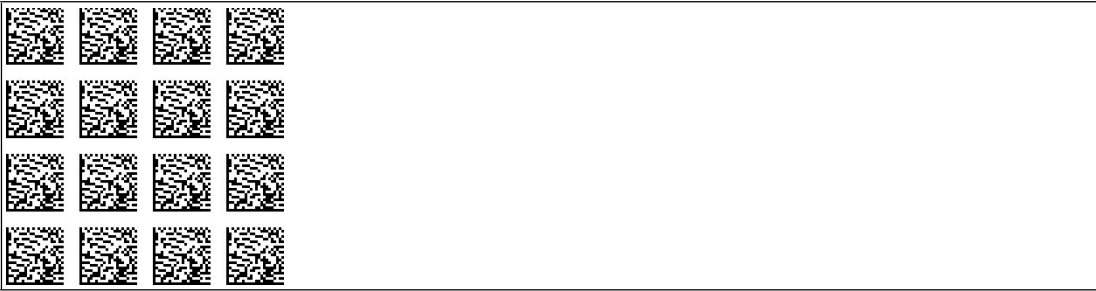

Figure 6.7 The code card assigns the 20 kBaud baud rate to the read head

Baud Rate: 50 kBaud

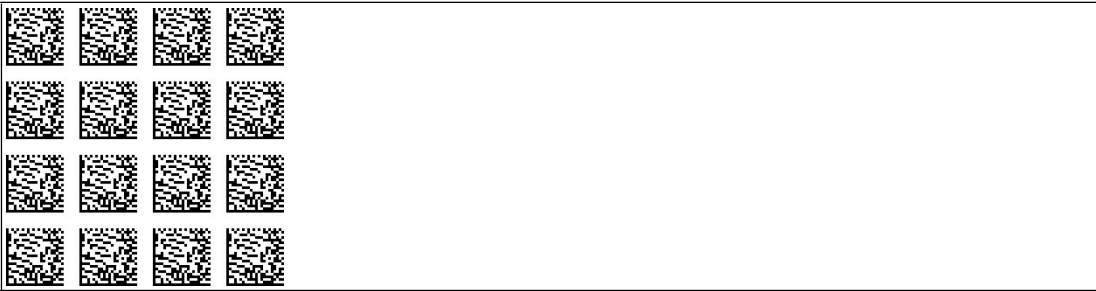

Figure 6.8 The code card assigns the 50 kBaud baud rate to the read head

Baud Rate: 125 kBaud

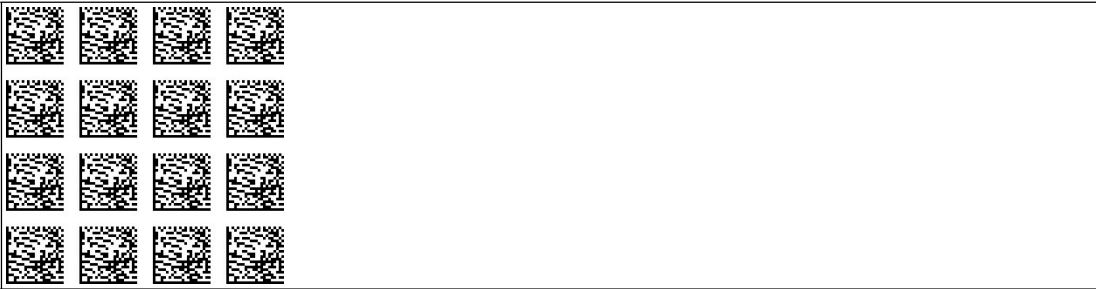

Figure 6.9 The code card assigns the 125 kBaud baud rate to the read head

Baud Rate: 250 kBaud



Figure 6.10 The code card assigns the 250 kBaud baud rate to the read head

Baud Rate: 500 kBaud



Figure 6.11 The code card assigns the 500 kBaud baud rate to the read head

Baud Rate: 1 MBaud



Figure 6.12 The code card assigns the 1 MBaud baud rate to the read head

Auto Baud Rate



Figure 6.13 The code card assigns the auto baud rate to the read head.

FACTORY AUTOMATION – SENSING YOUR NEEDS



Worldwide Headquarters

Pepperl+Fuchs GmbH
68307 Mannheim · Germany
Tel. +49 621 776-0
E-mail: info@de.pepperl-fuchs.com

USA Headquarters

Pepperl+Fuchs Inc.
Twinsburg, Ohio 44087 · USA
Tel. +1 330 4253555
E-mail: sales@us.pepperl-fuchs.com

Asia Pacific Headquarters

Pepperl+Fuchs Pte Ltd.
Company Registration No. 199003130E
Singapore 139942
Tel. +65 67799091
E-mail: sales@sg.pepperl-fuchs.com

www.pepperl-fuchs.com

 **PEPPERL+FUCHS**
SENSING YOUR NEEDS

Subject to modifications
Copyright PEPPERL+FUCHS • Printed in Germany

/ DOCT3706E
09/2016