

MANUAL

Pulscon LTC57 PROFIBUS PA Guided Level Radar

Level measurement in bulk solids

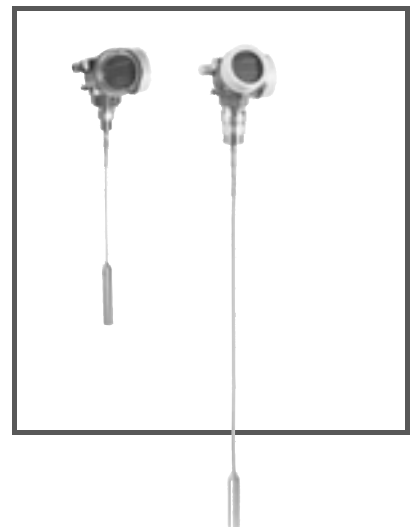



With regard to the supply of products, the current issue of the following document is applicable:
The General Terms of Delivery for Products and Services of the Electrical Industry,
published by the Central Association of the Electrical Industry (Zentralverband Elektrotechnik und
Elektroindustrie (ZVEI) e.V.) in its most recent version as well as the supplementary clause:
"Expanded reservation of proprietorship"



1	Important document information	6
1.1	Document function	6
1.2	Symbols	6
1.3	Supplementary documentation	9
2	Basic safety instructions	11
2.1	Requirements for the personnel	11
2.2	Designated use	11
2.3	Workplace safety	12
2.4	Operational safety	12
2.5	Product safety	12
3	Product description	13
3.1	Design	13
3.2	Registered trademarks	15
4	Incoming acceptance and product identification	16
4.1	Incoming acceptance	16
4.2	Product identification	17
5	Storage, Transport	19
5.1	Storage conditions	19
5.2	Transport product to the measuring point	19
6	Mounting	20
6.1	Mounting requirements	20
6.2	Mounting the device	34
6.3	Post-installation check	41
7	Electrical connection	42
7.1	Connection conditions	42
7.2	Connecting the device	46
7.3	Post-connection check	48



8	Operating options	49
8.1	Overview	49
8.2	Structure and function of the operating menu	51
8.3	Display and operating module	57
9	Integration into a PROFIBUS network	65
9.1	Overview of the device database files (GSD)	65
9.2	Set device address	65
10	Commissioning (via operating menu)	67
10.1	Installation and function check	67
10.2	Setting the operating language	67
10.3	Configuration of a level measurement	68
10.4	Recording the reference curve	69
10.5	Configuration of the on-site display	70
10.6	Configuration management	71
10.7	Protection of the settings against unauthorized changes	71
11	Diagnostics and troubleshooting	72
11.1	General trouble shooting	72
11.2	Diagnostic information on local display	74
11.3	Diagnostic event in the operating tool	77
11.4	Diagnostic list	78
11.5	List of diagnostic events	78
11.6	Event logbook	81
11.7	Firmware history	83
12	Maintenance	84
12.1	Exterior cleaning	84



13 Repairs	85
13.1 General information on repairs	85
13.2 Spare parts	86
13.3 Return	86
13.4 Disposal	86
14 Accessories	87
14.1 Device-specific accessories	87
14.2 Communication-specific accessories	90
14.3 Service-specific accessories	90
14.4 System components	90
15 Operating menu	91
15.1 Overview of the operating menu (display module)	91
15.2 Overview of the operating menu (operating tool)	96
15.3 Setup menu	101
15.4 Diagnostics menu	149
Index	166



1 Important document information

1.1 Document function

These Operating Instructions contain all the information that is required in various phases of the life cycle of the device: from product identification, incoming acceptance and storage, to mounting, connection, operation and commissioning through to troubleshooting, maintenance and disposal.

1.2 Symbols

1.2.1 Symbols used

This document contains information that you must read for your own personal safety and to avoid property damage. Depending on the risk level, the warning messages are displayed in descending order as follows:

Safety-relevant symbols



Danger!

This symbol indicates an imminent danger.

Non-observance will result in personal injury or death.



Warning!

This symbol indicates a possible fault or danger.

Non-observance may cause personal injury or serious property damage.



Caution!

This symbol indicates a possible fault.

Non-observance could interrupt the device and any connected systems and plants, or result in their complete failure.

Informative symbols



Note!

This symbol brings important information to your attention.



Action

This symbol indicates a paragraph with instructions.

1.2.2 Electrical symbols







Symbol	Meaning
	Direct current A terminal to which DC voltage is applied or through which direct current flows.
	Alternating current A terminal to which alternating voltage is applied or through which alternating current flows.
	Direct current and alternating current <ul style="list-style-type: none"> • A terminal to which alternating voltage or DC voltage is applied. • A terminal through which alternating current or direct current flows.
	Ground connection A grounded terminal which, as far as the operator is concerned, is grounded via a grounding system.
	Protective ground connection A terminal which must be connected to ground prior to establishing any other connections.
	Equipotential connection A connection that has to be connected to the plant grounding system: This may be a potential equalization line or a star grounding system depending on national or company codes of practice.

Table 1.1

1.2.3 Tool symbols





Symbol	Meaning
	Torx screwdriver
	Flat blade screwdriver
	Cross-head screwdriver
	Allen key
	Hexagon wrench

Table 1.2

1.2.4 Symbols for certain types of information





Symbol	Meaning
	Allowed Indicates procedures, processes or actions that are allowed.
	Preferred Indicates procedures, processes or actions that are preferred.
	Forbidden Indicates procedures, processes or actions that are forbidden.
	Series of steps
	Result of a sequence of actions

Table 1.3

1.2.5 Symbols in graphics

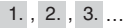

Symbol	Meaning
1, 2, 3 ...	Item numbers
	Series of steps
A, B, C, ...	Views
A-A, B-B, C-C, ...	Sections
	Hazardous area Indicates a hazardous area.
	Safe area (non-hazardous area) Indicates a non-hazardous location.

Table 1.4

1.2.6 Symbols at the device

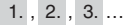

Symbol	Meaning
	Safety instructions Observe the safety instructions contained in the associated Operating Instructions.
	Temperature resistance of the connection cables Specifies the minimum value of the temperature resistance of the connection cables.

Table 1.5

1.3 Supplementary documentation

Document	Purpose and content of the document
Technical Information TI01004O (LTC57)	Planning aid for your device The document contains all the technical data on the device and provides an overview of the accessories and other products that can be ordered for the device.
Brief Operating Instructions KA01073O (LTC57, PROFIBUS PA)	Guide that takes you quickly to the 1st measured value The Brief Operating Instructions contain all the essential information from incoming acceptance to initial commissioning.
Description of Device Parameters GP01001O (LTC5X, PROFIBUS PA)	Reference for your parameters The document provides a detailed explanation of each individual parameter in the operating menu. The description is aimed at those who work with the device over the entire life cycle and perform specific configurations.

Table 1.6



Note!

For an overview of the scope of the associated Technical Documentation, refer to www.pepperl-fuchs.com.

1.3.1 Safety documentation

Depending on the approval, the following Safety instructions (SI) are supplied with the device. They are an integral part of the Operating instructions.

Safety instructions (SI)

Feature "Approval"	Approval	Feature "Electrical output"				
		Option IH ^a	Option ID ^b	Option IE ^c	Option PA ^d	Option AH ^e Option DH ^f
E1	ATEX II 1G Ex ia IIC T6-T1 Ga	SI00496O	SI01125O	SI01126O	SI00516O	–
EX	ATEX II 1/2G Ex ia IIC T6-T1 Ga/Gb	SI00496O	SI01125O	SI01126O	SI00516O	–
S3	ATEX II 1D Ex ta IIIC T _{500xx} °C Da	SI00501O	SI00501O	SI00501O	SI00521O	SI00501O
S4	ATEX II 1/2D Ex ta IIIC Txx° C Da/Db	SI00501O	SI00501O	SI00501O	SI00521O	SI00501O
E3	ATEX II 3G Ex nA IIC T6-T1 Gc	SI00498O	SI01130O	SI01131O	SI00518O	SI01132O
E4	ATEX II 3G Ex ic IIC T6-T1 Gc	SI00498O	SI01130O	SI01131O	SI00518O	–
SX	ATEX II 1/2G Ex ia IIC T6-T1 Ga/Gb ATEX II 1/2D Ex ia IIIC Txx° C Da/Db	SI00502O	SI00502O	SI00502O	SI00522O	–
EG	ATEX II 1/2G Ex d [ia] IIC T6-T1 Ga/Gb ATEX II 1/2D Ex ta IIIC Txx° C Da/Db	SI00503O	SI00503O	SI00503O	SI00523O	SI01136O

2015-03

Feature "Approval"	Approval	Feature "Electrical output"				
		Option IH ^a	Option ID ^b	Option IE ^c	Option PA ^d	Option AH ^e Option DH ^f
CD	CSA C/US DIP Cl.II,III Div.1 Gr.E-G	SI00529O	SI00529O	SI00529O	SI00570O	SI00529O
C1	CSA C/US IS Cl.I,II,III Div.1 Gr.A-G, NI Cl.1 Div.2, Ex ia	SI00530O	SI00530O	SI00530O	SI00571O	SI00530O
C2	CSA C/US XP Cl.I,II,III Div.1 Gr.A-G, NI Cl.1 Div.2, Ex d	SI00529O	SI00529O	SI00529O	SI00570O	SI00529O
FI	FM IS Cl.I,II,III Div.1 Gr.A-G, AEx ia, NI Cl.1 Div.2	SI00531O	SI00531O	SI00531O	SI00573O	SI00531O
FN	FM XP Cl.I,II,III Div.1 Gr.A-G, AEx d, NI Cl.1 Div.2	SI00532O	SI00532O	SI00532O	SI00572O	SI00532O
FE	FM DIP Cl.II,III Div.1 Gr.E-G	SI00532O	SI00532O	SI00532O	SI00572O	SI00532O
IA	IECEX Ex ia IIC T6-T1 Ga	SI00496O	SI01125O	SI01126O	SI00516O	-
IB	IECEX Ex ia IIC T6-T1 Ga/Gb	SI00496O	SI01125O	SI01126O	SI00516O	-
IE	IECEX Ex ta IIC T ₅₀₀ xx°C Da	SI00501O	SI00501O	SI00501O	SI00521O	SI00501O
IF	IECEX Ex ta IIC Txx°C Da/Db	SI00501O	SI00501O	SI00501O	SI00521O	SI00501O
IG	IECEX Ex nA IIC T6-T1 Gc	SI00498O	SI01130O	SI01131O	SI00518O	SI01132O
IH	IECEX Ex ic IIC T6-T1 Gc	SI00498O	SI01130O	SI01131O	SI00518O	-

Table 1.7

- ^a Option IH: 2-wire, 4 ... 20 mA, HART
- ^b Option ID: 2-wire, 4 ... 20 mA, HART, switching output
- ^c Option IE: 2-wire, 4 ... 20 mA, HART, 4 ... 20 mA
- ^d Option PA: 2-wire, PROFIBUS PA, switching output
- ^e Option AH: 4-wire, 90 ... 253 V AC, 4 ... 20 mA, HART
- ^f Option DH: 4-wire, 10.4 ... 48 V DC, 4 ... 20 mA, HART



Note!

For certified devices the relevant Safety instructions (SI) are indicated on the nameplate.

2 Basic safety instructions

2.1 Requirements for the personnel

The personnel for installation, commissioning, diagnostics and maintenance must fulfill the following requirements:

- Trained, qualified specialists must have a relevant qualification for this specific function and task
- Are authorized by the plant owner/operator
- Are familiar with federal/national regulations
- Before beginning work, the specialist staff must have read and understood the instructions in the Operating Instructions and supplementary documentation as well as in the certificates (depending on the application)
- Following instructions and basic conditions

The operating personnel must fulfill the following requirements:

- Being instructed and authorized according to the requirements of the task by the facility's owner-operator
- Following the instructions in these Operating Instructions

2.2 Designated use

Application and measured materials

The measuring device described in these Operating Instructions is intended only for level measurement of bulk solids. Depending on the version ordered the device can also measure potentially explosive, flammable, poisonous and oxidizing materials.

Observing the limit values specified in the "Technical data" and listed in the Operating Instructions and supplementary documentation, the measuring device may be used for the following measurements only:

- Measured process variable: Level
- Calculated process variables: Volume or mass in arbitrarily shaped vessels (calculated from the level by the linearization functionality)

To ensure that the measuring device remains in proper condition for the operation time:

- Use the measuring device only for measured materials against which the process-wetted materials are adequately resistant.
- Observe the limit values in "Technical data".

Incorrect use

The manufacturer is not liable for damage caused by improper or non-designated use.

Verification for borderline cases:

- For special measured materials and cleaning agents, Pepperl+Fuchs is glad to provide assistance in verifying the corrosion resistance of wetted materials, but does not accept any warranty or liability.

Residual risk

The electronics housing and its built-in components such as display module, main electronics module and I/O electronics module may heat to 80 °C (176 °F) during operation through heat transfer from the process as well as power dissipation within the electronics. During operation the sensor may assume a temperature near the temperature of the measured material.

Danger of burns due to heated surfaces!

- For high process temperatures: Install protection against contact in order to prevent burns.

2.3 Workplace safety

For work on and with the device:

- Wear the required personal protective equipment according to federal/national regulations.

2.4 Operational safety

Risk of injury.

- Operate the device in proper technical condition and fail-safe condition only.
- The operator is responsible for interference-free operation of the device.

Conversions to the device

Unauthorized modifications to the device are not permitted and can lead to unforeseeable dangers.

- If, despite this, modifications are required, consult with the manufacturer.

Repair

To ensure continued operational safety and reliability,

- Carry out repairs on the device only if they are expressly permitted.
- Observe federal/national regulations pertaining to repair of an electrical device.
- Use original spare parts and accessories from the manufacturer only.

Hazardous area

To eliminate a danger for persons or for the facility when the device is used in the hazardous area (e. g. explosion protection, pressure vessel safety):

- Based on the nameplate, check whether the ordered device is permitted for the intended use in the hazardous area.
- Observe the specifications in the separate supplementary documentation that is an integral part of these Instructions.

2.5 Product safety

This measuring device is designed in accordance with good engineering practice to meet state-of-the-art safety requirements, has been tested, and left the factory in a condition in which they are safe to operate.

It meets general safety standards and legal requirements. It also complies with the EC directives listed in the device-specific EC Declaration of Conformity. Pepperl+Fuchs confirms this by affixing the CE mark to the device.

3 Product description

3.1 Design

3.1.1 Device

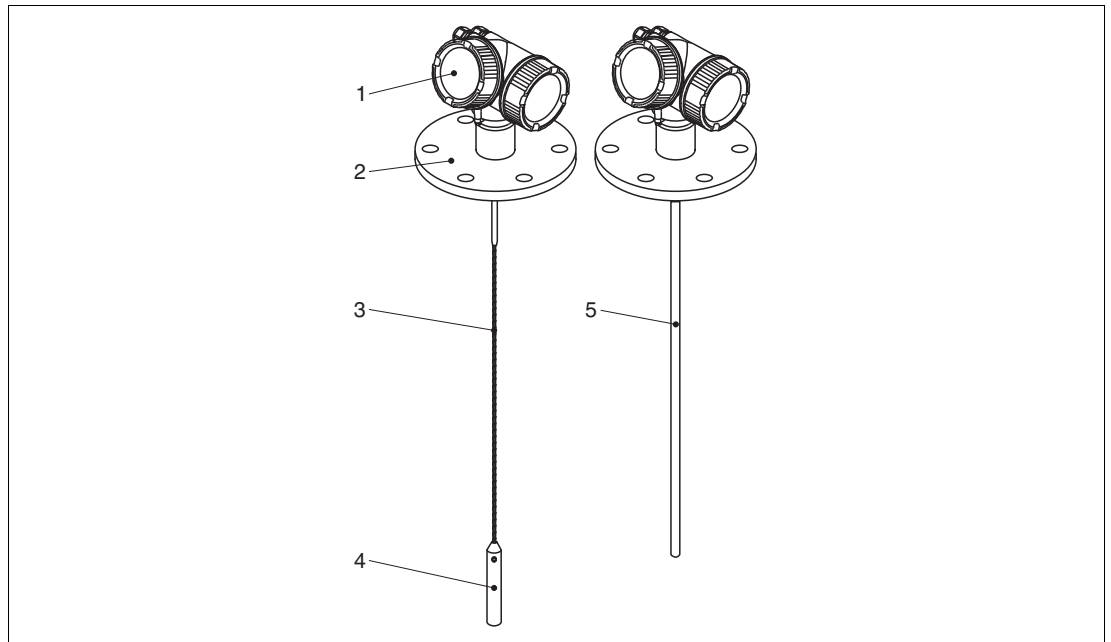

Figure 3.1 Design

- 1 Electronics housing
- 2 Process connection (here as an example: flange)
- 3 Rope probe
- 4 End-of-probe weight
- 5 Rod probe

3.1.2 Electronics housing

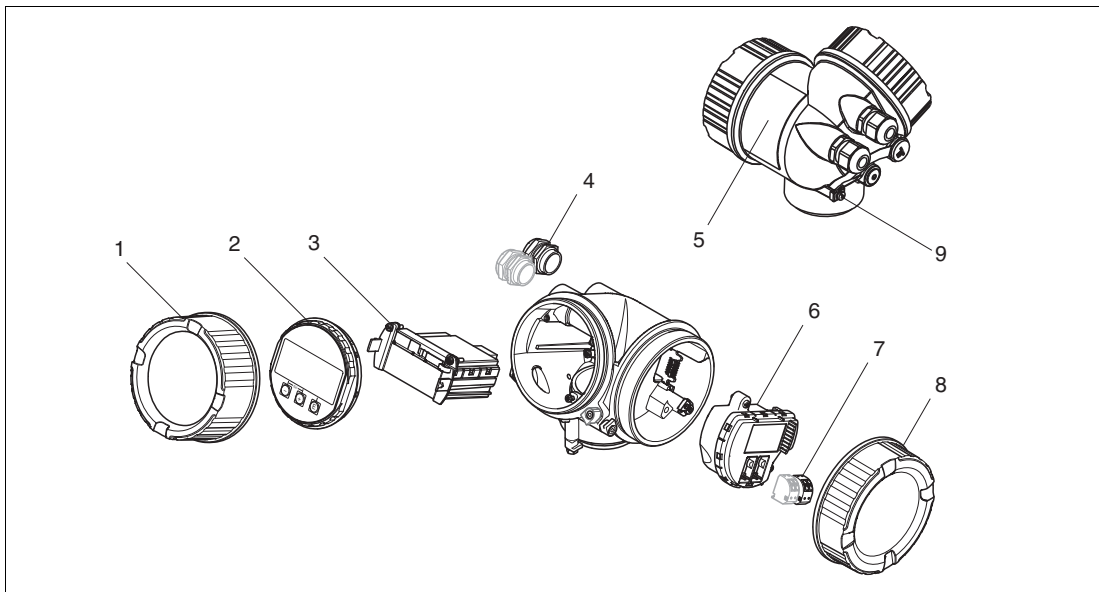

Figure 3.2 Design of the electronics housing

- 1 Electronics compartment cover
- 2 Display module
- 3 Main electronics module
- 4 Cable glands (1 or 2, depending on instrument version)
- 5 Nameplate
- 6 I/O electronics module
- 7 Terminals (pluggable spring terminals)
- 8 Connection compartment cover
- 9 Grounding terminal

3.2 Registered trademarks

HART®

- Registered trademark of the HART Communication Foundation, Austin, USA

PROFIBUS®

- Registered trademark of the PROFIBUS User Organization, Karlsruhe, Germany

KALREZ®, VITON®

- Registered trademark of DuPont Performance Elastomers L.L.C., Wilmington, USA

TEFLON®

- Registered trademark of E.I. DuPont de Nemours & Co., Wilmington, USA

TRI CLAMP®

- Registered trademark of Alfa Laval Inc., Kenosha, USA



4 Incoming acceptance and product identification

4.1 Incoming acceptance







		<p>Is the order code on the delivery note (1) identical to the order code on the product sticker (2)?</p>
		<p>Are the goods undamaged?</p>
		<p>Do the nameplate data match the ordering information on the delivery note?</p>
		<p>Is the DVD (operating tool) present? If required (see nameplate): Are the Safety Instructions (SI) present?</p>

Table 4.1

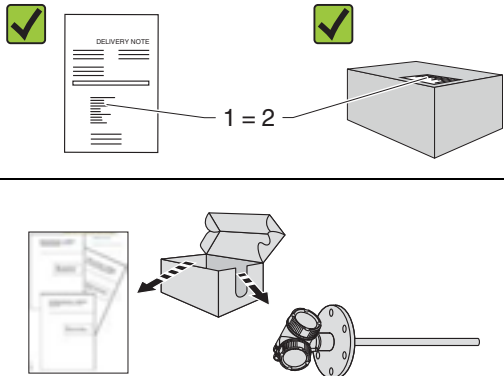

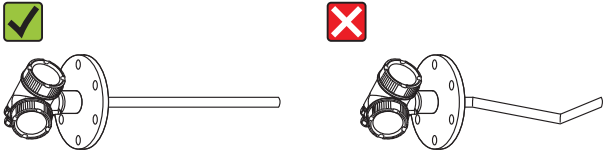
Note!

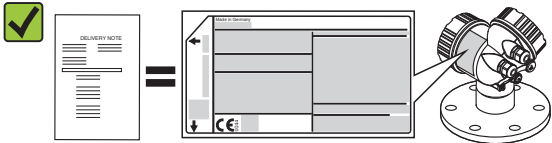
If one of the conditions does not comply, contact your Pepperl+Fuchs distributor.

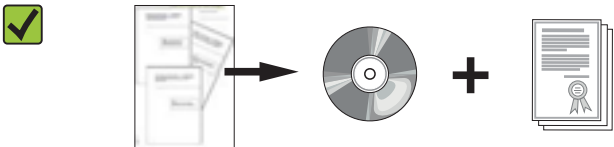
4.2 Product identification

The following options are available for identification of the measuring device:

- Nameplate specifications
- Order code with breakdown of the device features on the delivery note
- Scan the 2-D matrix code (QR code) on the nameplate: all the information for the measuring device is displayed.

Nameplate

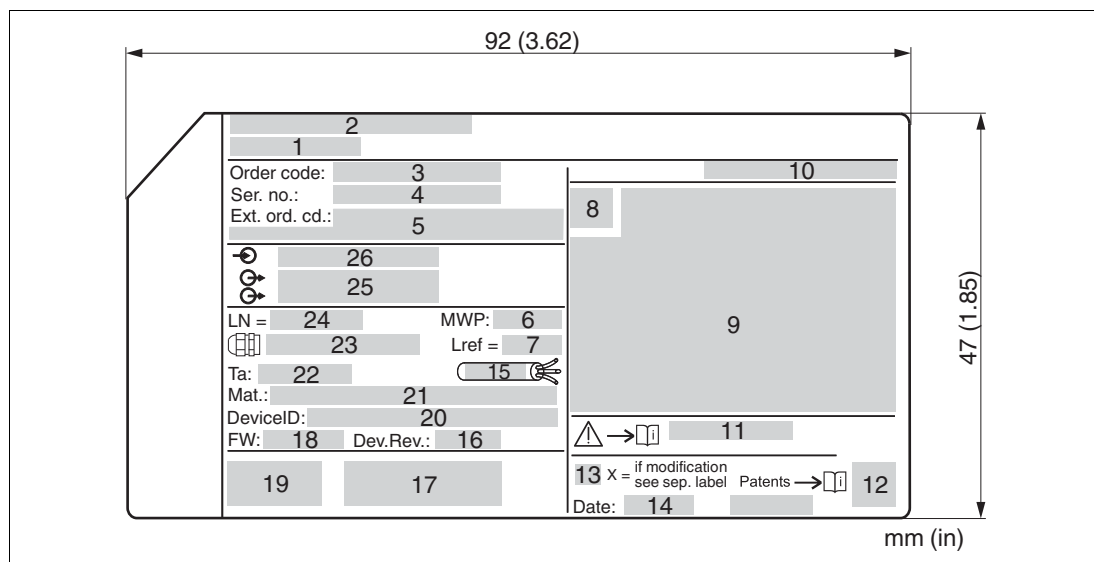

Figure 4.1 Nameplate

- 1 Device name
- 2 Address of manufacturer
- 3 Order code
- 4 Serial number (Ser. no.)
- 5 Extended order code (Ext. ord. cd.)
- 6 Process pressure
- 7 Gas phase compensation: reference distance
- 8 Certificate symbol
- 9 Certificate and approval relevant data
- 10 Degree of protection: e. g. IP, NEMA
- 11 Document number of the Safety Instructions: e. g. SI, ZD, ZE
- 12 2-D matrix code (QR code)
- 13 Modification mark
- 14 Manufacturing date: year-month
- 15 Permitted temperature range for cable
- 16 Device revision (Dev.Rev.)
- 17 Additional information about the device version (certificates, approvals, communication): e. g. SIL, PROFIBUS
- 18 Firmware version (FW)
- 19 CE mark, C-Tick



- 20 Device ID
- 21 Material in contact with process
- 22 Permitted ambient temperature (T_{amb})
- 23 Size of the thread of the cable glands
- 24 Length of probe
- 25 Signal outputs
- 26 Operating voltage



Note!

Only 33 digits of the extended order code can be indicated on the nameplate. If the extended order code exceeds 33 digits, the rest will not be shown. However, the complete extended order code can be viewed in the operating menu of the device in the **Extended order code 1 to 3** parameter.

5 Storage, Transport

5.1 Storage conditions

- Permitted storage temperature: -40 ... +80 °C (-40 ... +176 °F)
- Use the original packaging.

5.2 Transport product to the measuring point



Warning!

Risk of injury!

Housing or probe may be damaged or break away.

- Transport the measuring device to the measuring point in its original packaging or at the process connection.
- Do not fasten lifting devices (hoisting slings, lifting eyes etc.) at the housing or the probe but at the process connection. Take into account the mass center of the device in order to avoid unintended tilting.
- Comply with the safety instructions, transport conditions for devices over 18 kg (39.6 lbs).

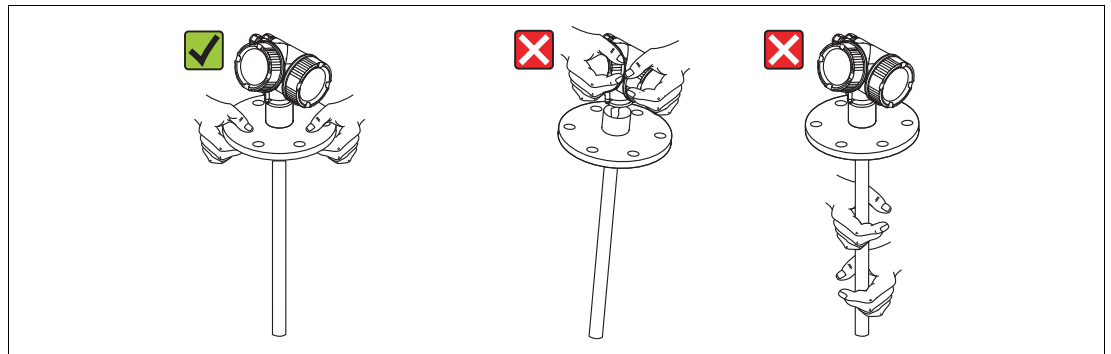

Figure 5.1

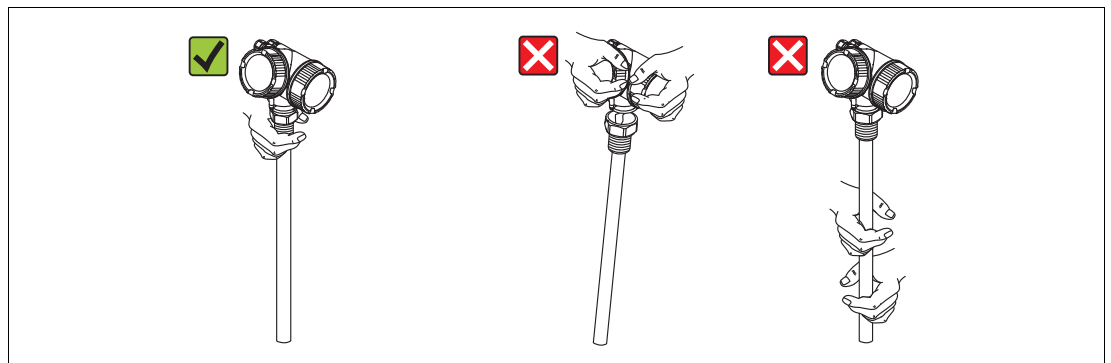

Figure 5.2

6 Mounting

6.1 Mounting requirements

6.1.1 Suitable mounting position

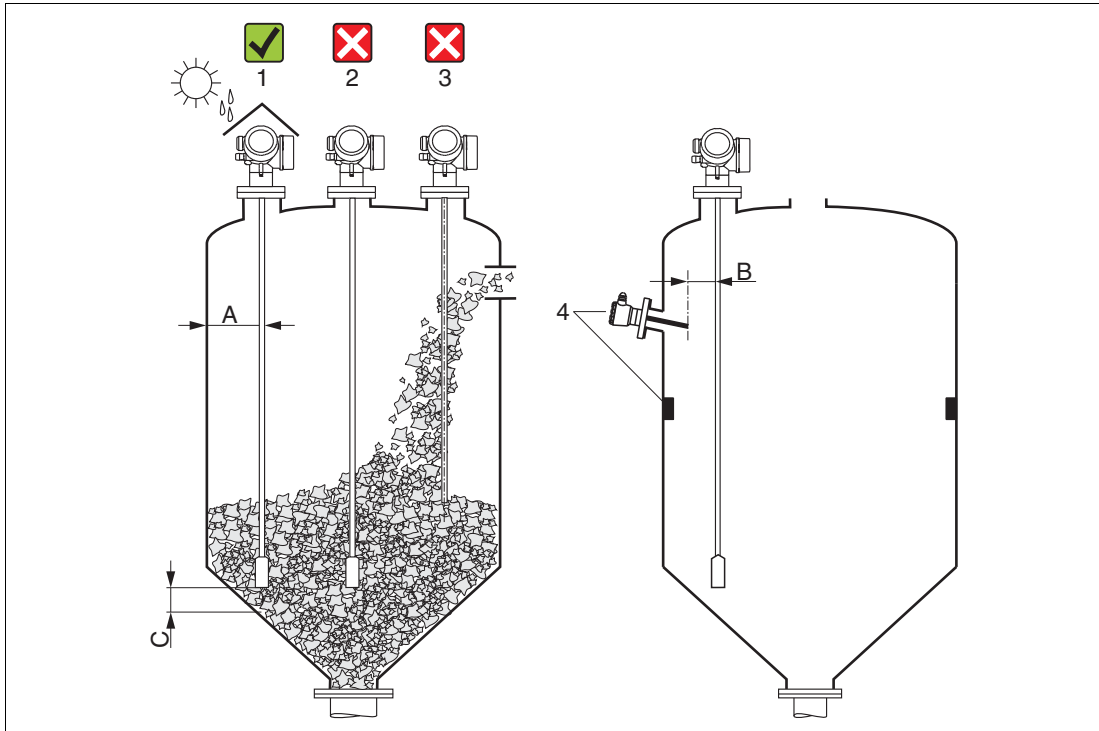

Figure 6.1 Mounting requirements

Mounting distances

- Distance (A) between wall and rod or rope probe:
 - for smooth metallic walls: > 50 mm (2 in)
 - for plastic walls: > 300 mm (12 in) to metallic parts outside the vessel
 - for concrete walls: > 500 mm (20 in), otherwise the available measuring range may be reduced.
- Distance (B) between rod or rope probe and internal fittings in the vessel: > 300 mm (12 in)
- Distance (C) from end of probe to bottom of the vessel:
 - Rope probe: > 150 mm (6 in)
 - Rod probe: > 10 mm (0.4 in)

Additional conditions

- When mounting in the open, a weather protection cover (1) may be installed to protect the device against extreme weather conditions.
- In metallic vessels: Preferably do not mount the probe in the center of the vessel (2), as this would lead to increased interference echoes.
If a central mounting position can not be avoided, it is crucial to perform an interference echo suppression (mapping) after the commissioning of the device.
- Do not mount the probe in the filling curtain (3).
- Avoid buckling the rope probe during installation or operation (e. g. through product movement against silo wall) by selecting a suitable mounting location.
- Check the probe regularly for defects.



Note!

With suspended rope probes (probe end not fixed at the bottom) the distance between the probe rope and internal fittings in the tank must not fall below 300 mm (12 in) during the entire process. A sporadic contact between the probe weight and the cone of the vessel, however, does not influence the measurement as long as the dielectric constant of the medium is at least $DC = 1.8$.



Note!

When mounting the electronics housing into a recess (e. g. in a concrete ceiling), observe a minimum distance of 100 mm (4 in) between the cover of the terminal compartment/electronics compartment and the wall. Otherwise the connection compartment/electronics compartment is not accessible after installation.

6.1.2 Applications with restricted mounting space

Mounting with remote sensor

The device version with a remote sensor is suited for applications with restricted mounting space. In this case the electronics housing is mounted at a separate position from which it is easier accessible.

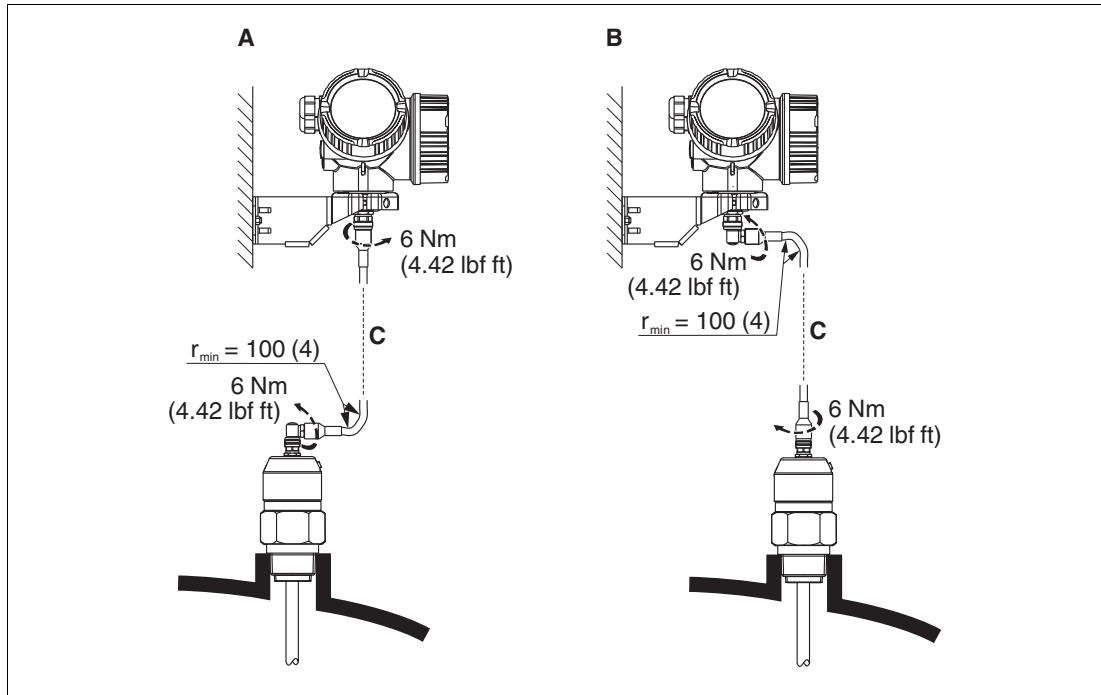

Figure 6.2

- A** Angled plug at the probe
- B** Angled plug at the electronics housing
- C** Length of the remote cable as ordered

- Product structure, feature "Probe design": option B "Sensor remote, 3 m/9 ft cable"
- The remote cable is supplied with these device versions, minimum bending radius: 100 mm (4 in)
- A mounting bracket for the electronics housing is supplied with these device versions. Mounting options:
 - Wall mounting
 - Pipe mounting; diameter: 42 to 60 mm (1-1/4 to 2 in)
- The connection cable has got one straight and one angled plug (90°). Depending on the local conditions the angled plug can be connected at the probe or at the electronics housing.



Note!

Probe, electronics and connection cable are adjusted to match each other. They are marked by a common serial number. Only components with the same serial number shall be connected to each other.

6.1.3 Notes on the mechanical load of the probe

Tensile load limit of rope probes

Feature "Probe"	Probe	Tensile load limit [kN]	Max. rupture load [kN] ^a
Option 2, 3	Rope 4 mm (1/6 in) 316	12	20
Option M, Q	Rope 6 mm (1/4 in) 316	30	42
Option N, S	Rope 6 mm (1/4 in) PA > Steel	12	20
Option R, T	Rope 8 mm (1/3 in) PA > Steel	30	42

Table 6.1

^a The ceiling of the silo must be designed to withstand this load.

Tensile load

Bulk solids exert tensile forces on rope probes whose height increases with:

- the length of the probe, i. e. max. cover
- the bulk density of the product,
- the silo diameter and
- the diameter of the probe rope

Since the tensile forces are also heavily dependent on the viscosity of the product, a higher safety factor is necessary for highly viscous products and if there is a risk of cornice buildup. In critical cases it is better to use a 6 mm rope instead of a 4 mm one.

The same forces also act on the silo cover. On a fixed rope, the tensile forces are definitely greater, but this can not be calculated. Observe the tensile strength of the probes.

Options for reducing the tensile forces:

- Shorten the probe.
- If the maximum tensile load is exceeded, check whether it would be possible to use a non-contact ultrasonic or level-radar device.

The following diagrams show typical loads for frequently occurring bulk solids as reference values. The calculation is performed for the following conditions:

- Calculation according to DIN 1055, Part 6 for the cylindrical part of the silo.
- Suspended probe (probe end not fixed at the bottom)
- Free-flowing bulk solid, i. e. mass flow. A calculation for core flow is not possible. In the event of collapsing cornices, considerably higher loads can occur.
- The specification for tensile forces contains the safety factor 2 (in addition to the safety factors already taken into account by DIN 1055), which compensates for the normal fluctuation range in pourable bulk solids.

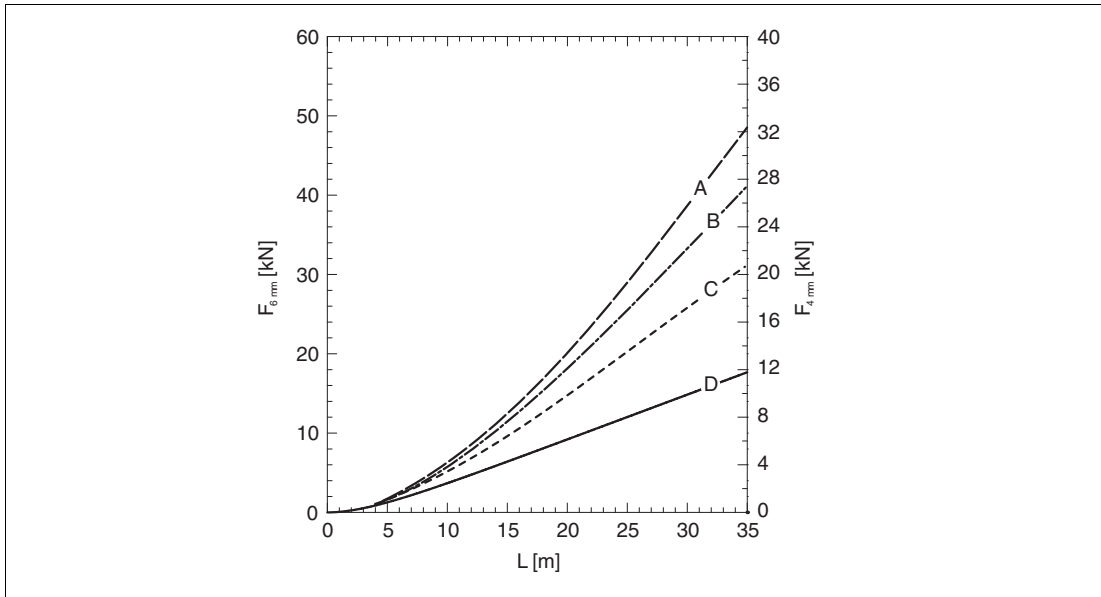

Figure 6.3 Silica sand in silo with smooth metallic walls; tensile load as a function of level L for rope diameters 6 mm (0.24 in) and 4 mm (0.16 in)

- A** Silo diameter 12 m (40 ft)
- B** Silo diameter 9 m (30 ft)
- C** Silo diameter 6 m (20 ft)
- D** Silo diameter 3 m (10 ft)

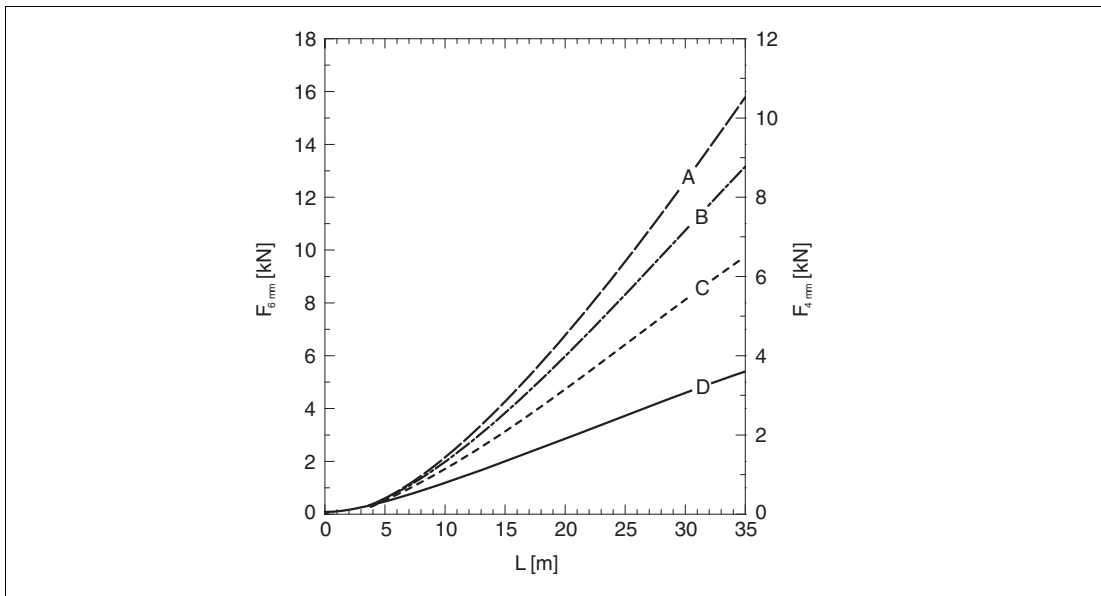

Figure 6.4 Polyethylene pellets in silo with smooth metallic walls; tensile load as a function of level L for rope diameters 6 mm (0.24 in) and 4 mm (0.16 in)

- A** Silo diameter 12 m (40 ft)
- B** Silo diameter 9 m (30 ft)
- C** Silo diameter 6 m (20 ft)
- D** Silo diameter 3 m (10 ft)

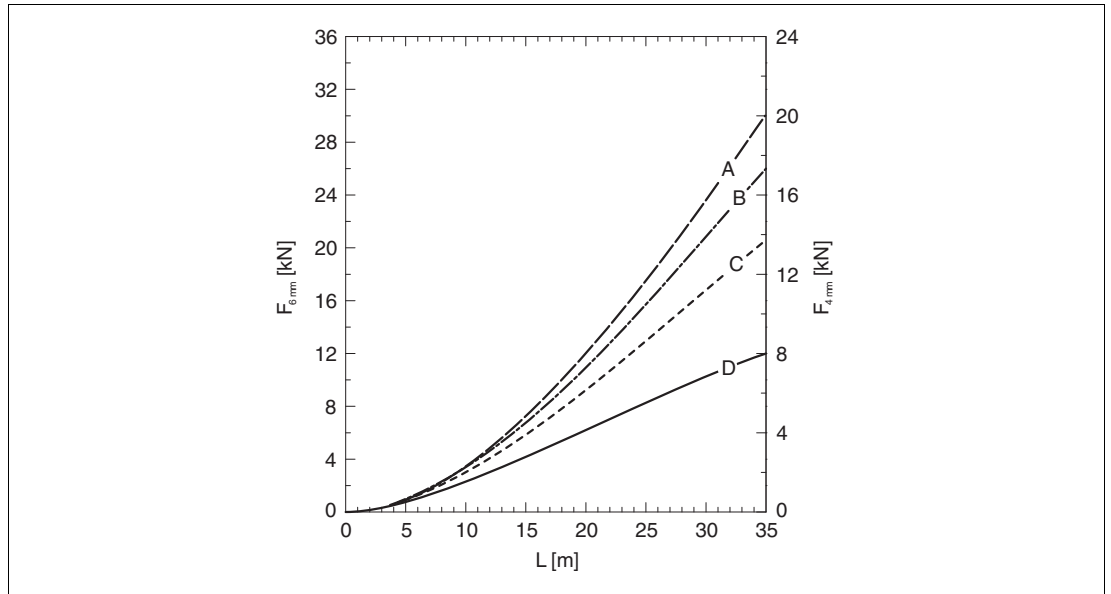

Figure 6.5 Wheat in silo with smooth metallic walls; tensile load as a function of level L for rope diameters 6 mm (0.24 in) and 4 mm (0.16 in)

- A** Silo diameter 12 m (40 ft)
- B** Silo diameter 9 m (30 ft)
- C** Silo diameter 6 m (20 ft)
- D** Silo diameter 3 m (10 ft)

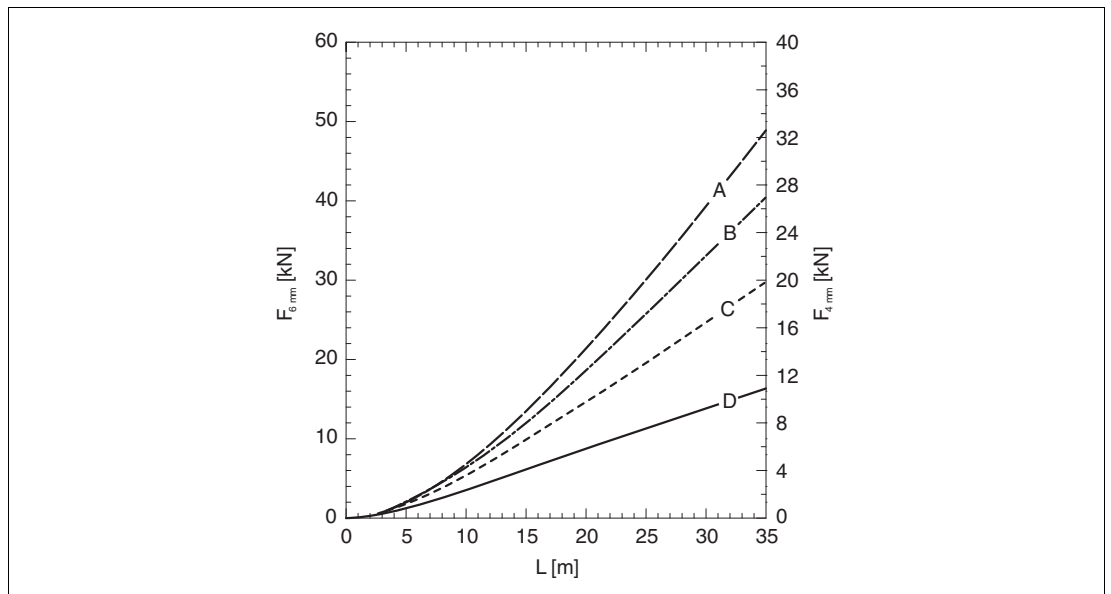

Figure 6.6 Cement in silo with smooth metallic walls; tensile load as a function of level L for rope diameters 6 mm (0.24 in) and 4 mm (0.16 in)

- A** Tank diameter 12 m (40 ft)
- B** Tank diameter 9 m (30 ft)
- C** Tank diameter 6 m (20 ft)
- D** Tank diameter 3 m (10 ft)

Bending strength of rod probes

Feature "Probe"	Probe	Bending strength [Nm]
Option L, P	Rod 16 mm (0.63 in) 316L	30

Table 6.2

6.1.4 Notes on the process connection

Probes are mounted to the process connection with threaded connections or flanges. If during this installation there is the danger that the probe end moves so much that it touches the tank floor or cone at times, the probe must, if necessary, be shortened and fixed down.

Threaded connection

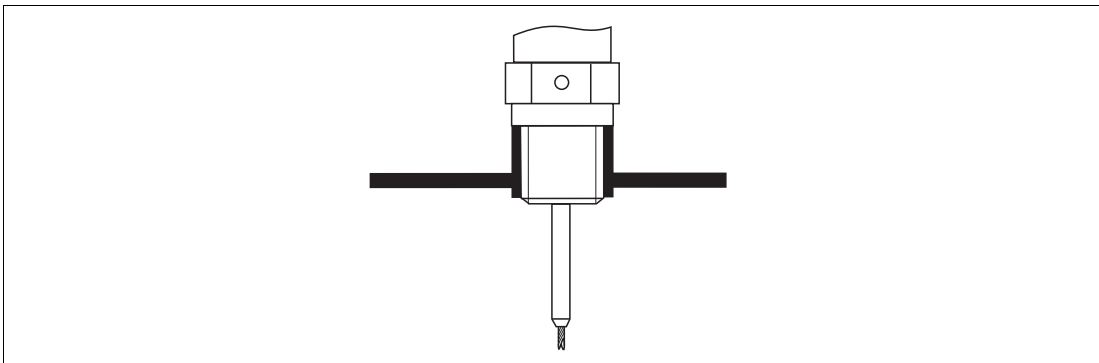

Figure 6.7 Mounting with threaded connection; flush with the container ceiling

Seal

The thread as well as the type of seal comply to DIN 3852 part 1, screwed plug form A.

They can be sealed with the following types of sealing rings:

- Thread G3/4: according to DIN 7603 with the dimensions 27 x 32 mm
- Thread G1-1/2: According to DIN 7603 with the dimensions 48 x 55 mm

Please use a sealing ring according to this standard in the form A, C or D and of a material that is resistant to the application.

Nozzle mounting

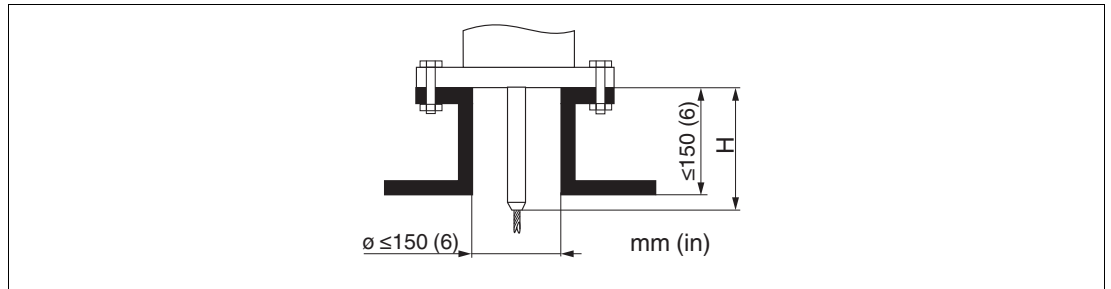

Figure 6.8

Length H of the rigid part of the rope probe

Probe	H
Rope Ø4 mm (0.16 in)	120 mm (4.7 in)
Rope Ø6 mm (0.24 in)	135 mm (5.3 in)

Table 6.3

- Permissible nozzle diameter: ≤ 150 mm (6 in).
For larger diameters the near range measuring capability may be reduced.
For nozzles \geq DN300: see next section.
- Permissible nozzle height ¹: ≤ 150 mm (6 in).
For a larger height the near range measuring capability may be reduced.
Larger nozzle heights may be possible in special cases: see next section.



Note!

With thermally insulated vessels the nozzle should also be insulated in order to prevent condensate formation.

Rod extension/centering

For devices with rope probes a rod extension/centering is available on request. It has to be used if otherwise the probe rope comes into contact with the lower edge of the nozzle.



Note!

Centering disks with small diameters (DN40 and DN50) may only be used if there is no significant build-up in the nozzle above the disk. The nozzle must not become clogged by the product.

¹ Larger nozzle heights on request.

Installation in nozzles \geq DN300

If installation in \geq 300 mm/12 in nozzles is unavoidable, installation must be carried out in accordance with the following sketch.

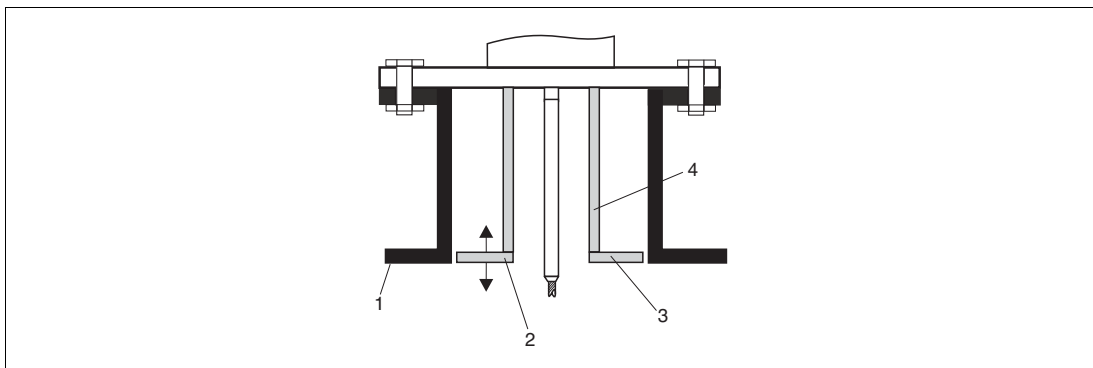

Figure 6.9

- 1 Lower edge of the nozzle
- 2 Approx. flush with the lower edge of the nozzle (\pm 50 mm/2 in)
- 3 Plate
- 4 Pipe diameter 150 to 180 mm (6 to 7 in)

Nozzle diameter	Plate diameter
300 mm (12 in)	280 mm (11 in)
\geq 400 mm (16 in)	\geq 350 mm (14 in)

Table 6.4

6.1.5 Securing the probe

Securing rope probes

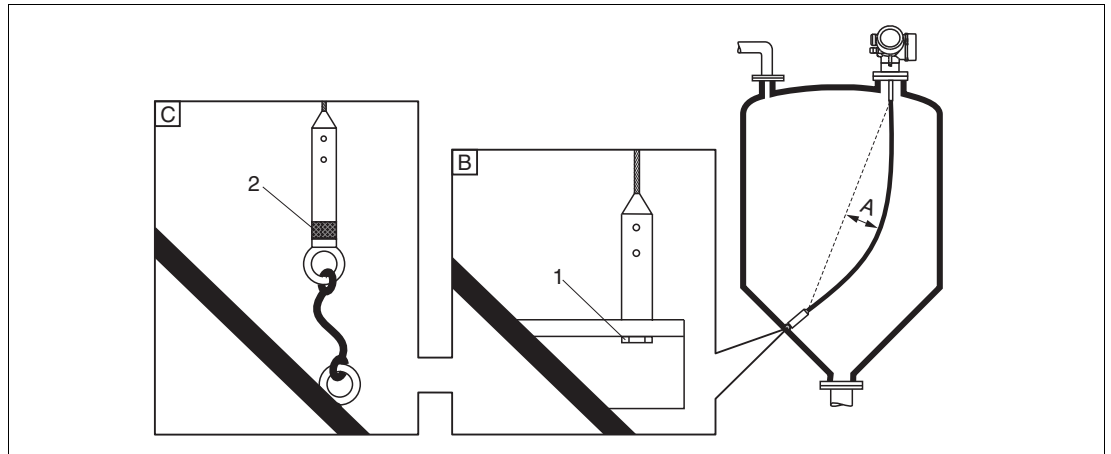

Figure 6.10

- A** Sag of the rope: ≥ 1 cm per 1 m of the probe length (0.12 in per 1 ft of the probe length)
- B** Reliably grounded end of probe
- C** Reliably isolated end of probe
- 1** Mounting and contact with a bolt
- 2** Mounting kit isolated

- The end of the probe needs to be secured under the following conditions:
 - if otherwise the probe sporadically comes into contact with the wall of the vessel, the outlet cone, internal fittings or other parts of the installation.
 - if otherwise the probe sporadically gets close to a concrete wall (minimum distance 0.5 m/20 in).
- The end of probe can be secured at its internal thread
 - rope 4 mm (1/6 in), 316: M14
 - rope 6 mm (1/4 in), 316: M20
 - rope 6 mm (1/4 in), PA > steel: M14
 - rope 8 mm (1/3 in), PA > steel: M20
- Preferably use the 6 mm (1/4 in) rope probe due to the higher tensile strength when fixing a rope probe.
- The fixing must be either reliably grounded or reliably insulated. If it is not possible to mount the probe weight with a reliably insulated connection, it can be secured using an isolated eyelet, which is available as an accessory.
- In the case of a grounded fixing the search for a positive end-of-probe signal must be activated. Otherwise an automatic probe length correction is impossible.
Navigation: Expert → Sensor → EOP evaluation → EOP search mode
Setting: **Positive EOP** option
- In order to prevent an extremely high tensile load (e. g. due to thermal expansion) and the risk of rope crack, the rope has to be slack. Make the rope longer than the required measuring range such that there is a sag in the middle of the rope that is ≥ 1 cm/(1 m rope length) [0.12 in/(1 ft rope length)].

Securing rod probes

- For Ex-approvals: For probe lengths ≥ 3 m (10 ft) a support is required.
- In general, rod probes must be supported if there is a horizontal flow (e. g. from an agitator) or in the case of strong vibrations.
- Rod probes may only be supported at the end of the probe.

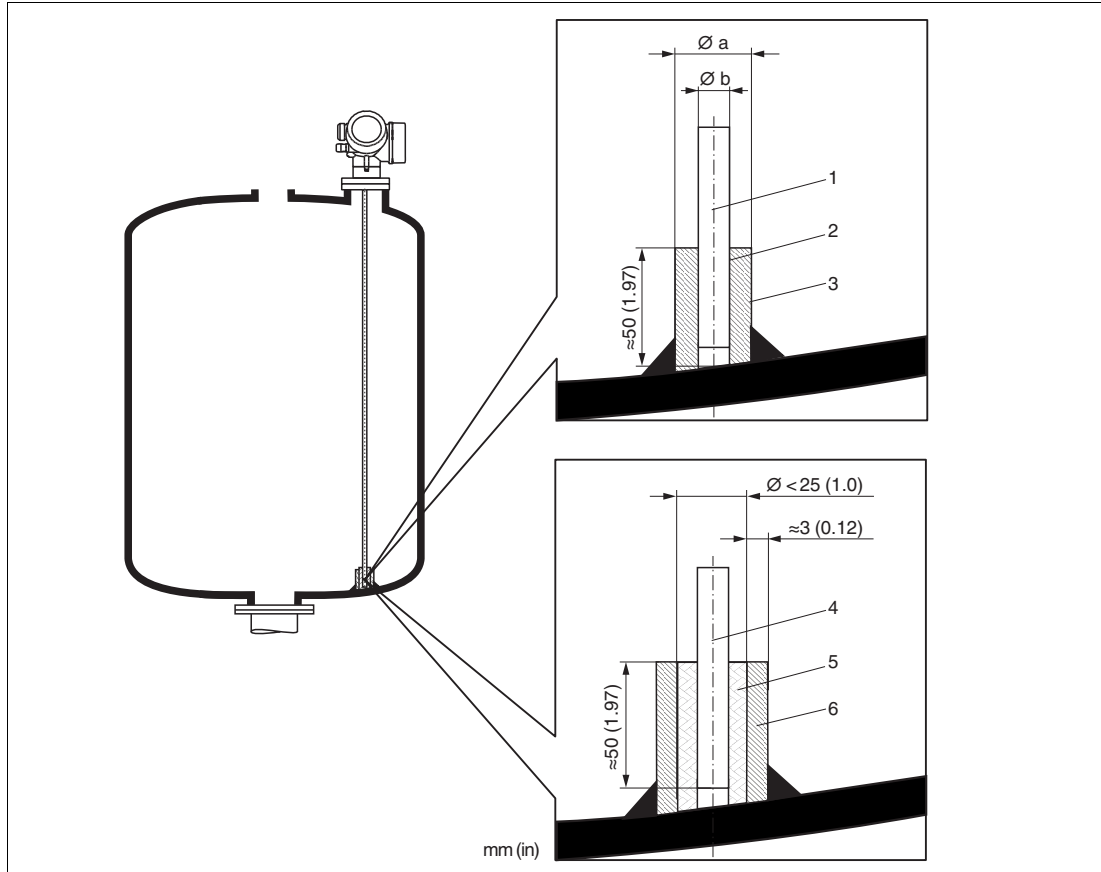

Figure 6.11

- 1 Probe rod, uncoated
- 2 Sleeve bored tight to ensure electrical contact between the rod and sleeve!
- 3 Short metal pipe, e. g. welded in place
- 4 Probe rod, coated
- 5 Plastic sleeve, e. g. PTFE, PEEK or PPS
- 6 Short metal pipe, e. g. welded in place



Warning!

Poor grounding of the end of probe may cause measuring errors.

- Apply a narrow sleeve which has good electrical contact to the probe.



Warning!

Welding may damage the main electronics module.

- Before welding: Ground the probe and dismount electronics.

6.1.6 Special mounting conditions

Concrete silos

Installation, for example, into a thick concrete ceiling should be made flush with the lower edge. Alternatively, the probe can also be installed into a pipe that must not protrude over the lower edge of the silo ceiling. The pipe should be kept at a minimum length. Installation suggestions see diagram.

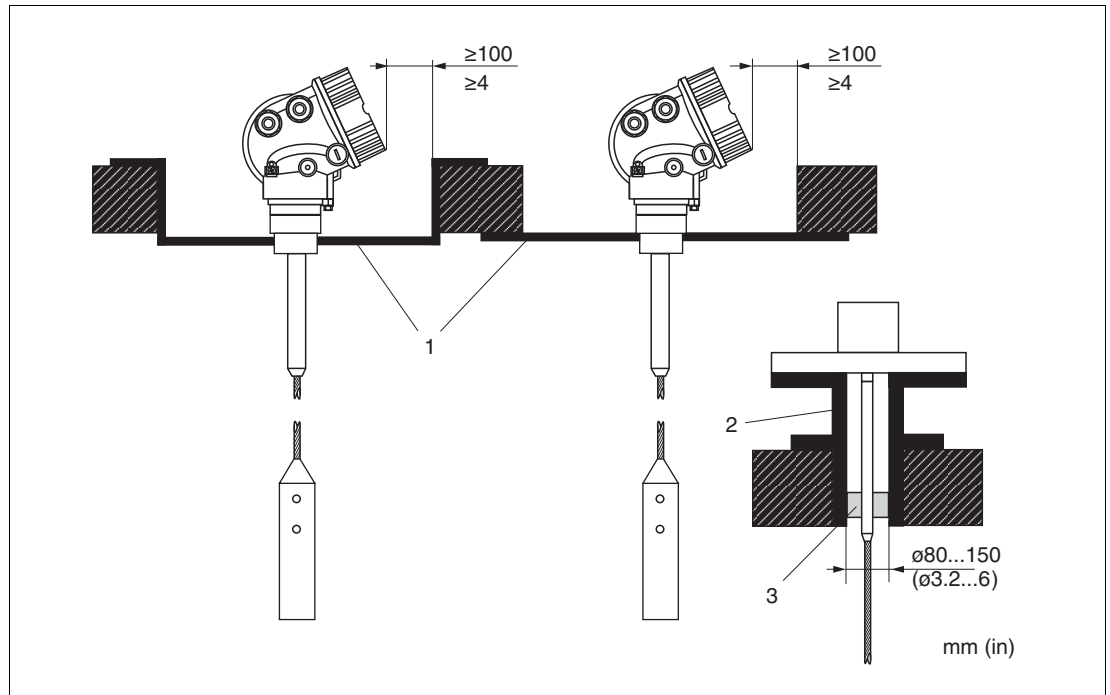

Figure 6.12

- 1 Metal sheet
- 2 Metal tube
- 3 Extension rod/centering

Note for installations with rod extension/center washer (on request): Strong dust generation can lead to build-up behind the center washer. This can cause an interference signal. For other installation possibilities please contact Pepperl+Fuchs.

Installation from the side

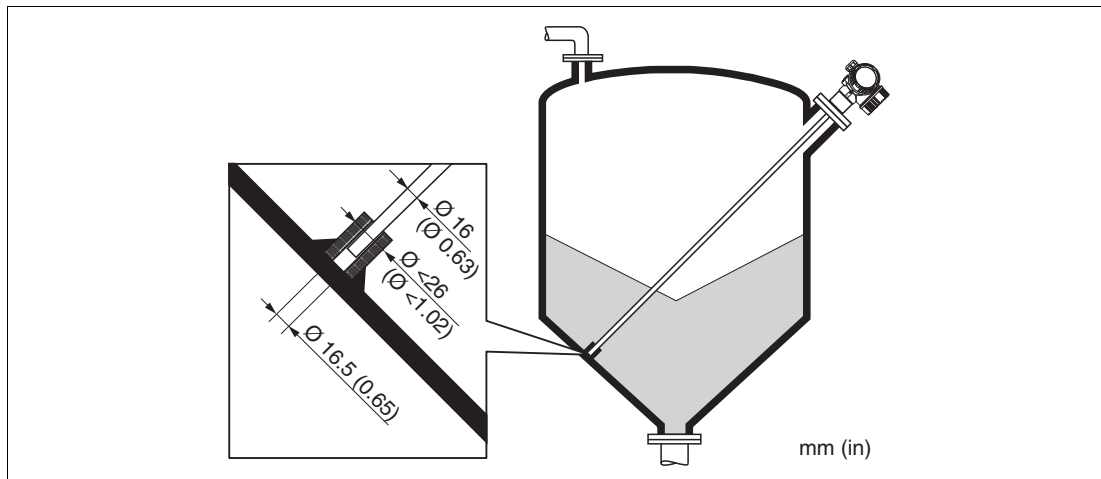

Figure 6.13

- If installation from above is not possible, the device can also be mounted from the side.
- In this case, always fix the rope probe.
- Support rod probe if the lateral load bearing capacity is exceeded. Only fix rod probes at the probe end.

Non-metallic vessels

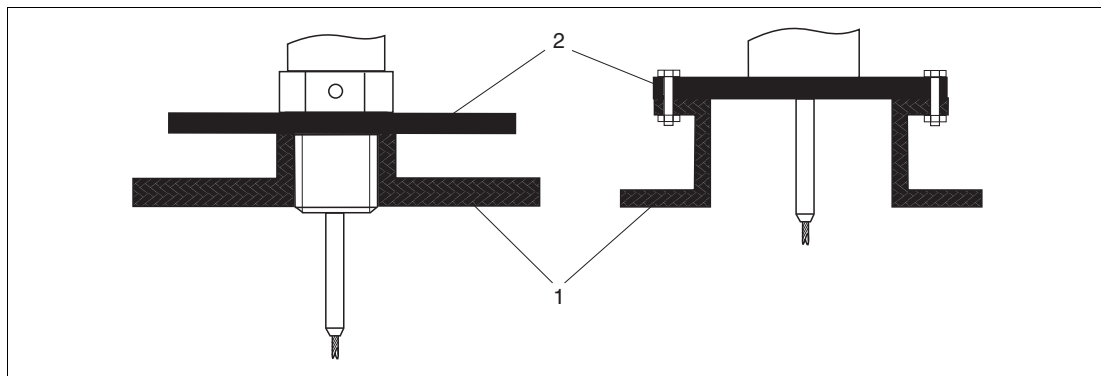

Figure 6.14

- 1 Non-metallic vessel
- 2 Metal sheet or metal flange

To measure, device with a rod probe needs a metallic surface at the process connection. Therefore:

- Select an instrument version with metal flange (minimum size DN50/2 in).
- Or: mount a metal sheet with a diameter of at least 200 mm (8 in) to the probe at the process connection. Its orientation must be perpendicular to the probe.



Vessels with heat insulation



Note!

If process temperatures are high, the device must be included in normal tank insulation to prevent the electronics heating up as a result of heat radiation or convection. The insulation may not exceed beyond the points labeled "MAX" in the drawings.

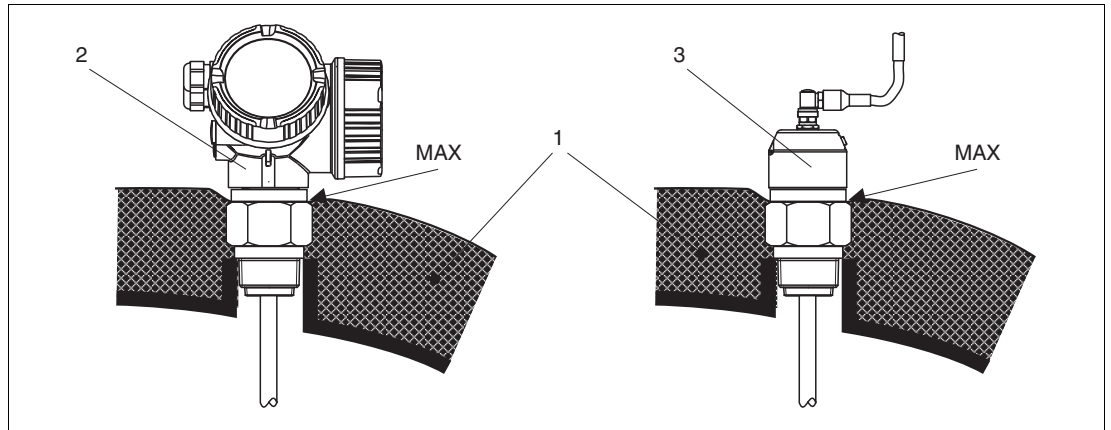

Figure 6.15 Process connection with thread

- 1 Tank insulation
- 2 Compact device
- 3 Sensor remote (feature "Probe design")

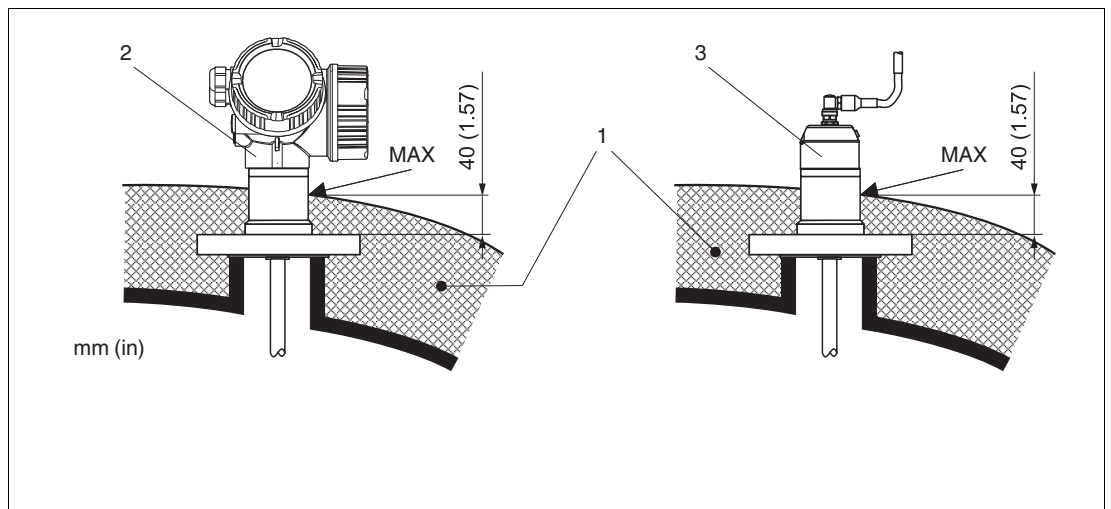

Figure 6.16 Process connection with flange

- 1 Tank insulation
- 2 Compact device
- 3 Sensor remote (feature "Probe design")

6.2 Mounting the device

6.2.1 Required mounting tools

- For mounting thread 3/4 in: Hexagonal wrench 36 mm
- For mounting thread 1-1/2 in: Hexagonal wrench 55 mm
- To shorten rod probes: Saw
- To shorten rope probes:
 - Allen key AF3 mm (for 4 mm ropes) or AF4 mm (for 6 mm ropes)
 - Saw or bolt cutter
- For flanges and other process connections: appropriate mounting tools
- To turn the housing: Hexagonal wrench 8 mm

6.2.2 Shortening the probe



Note!

When shortening the probe: Enter the new length of probe into the Quick Start Guide which can be found in the electronics housing behind the display module.

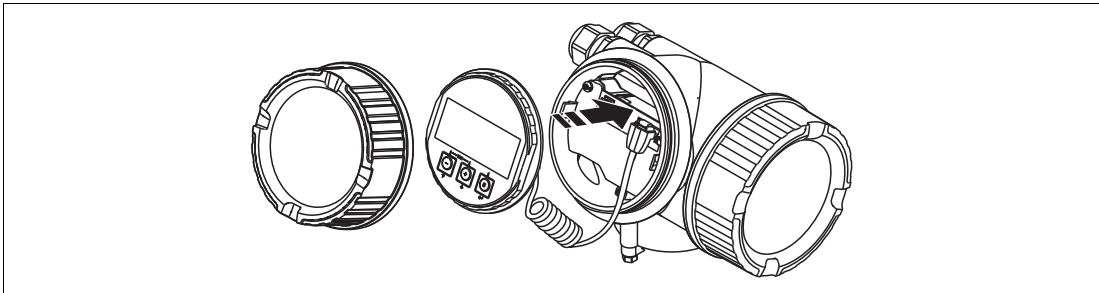

Figure 6.17

Shortening rod probes

Rod probes must be shortened if the distance to the container floor or outlet cone is less than 10 mm (0.4 in). The rods of a rod probe are shortened by sawing at the bottom end.

Shortening rope probes

Rope probes must be shortened if the distance to the container floor or outlet cone is less than 150 mm (6 in).

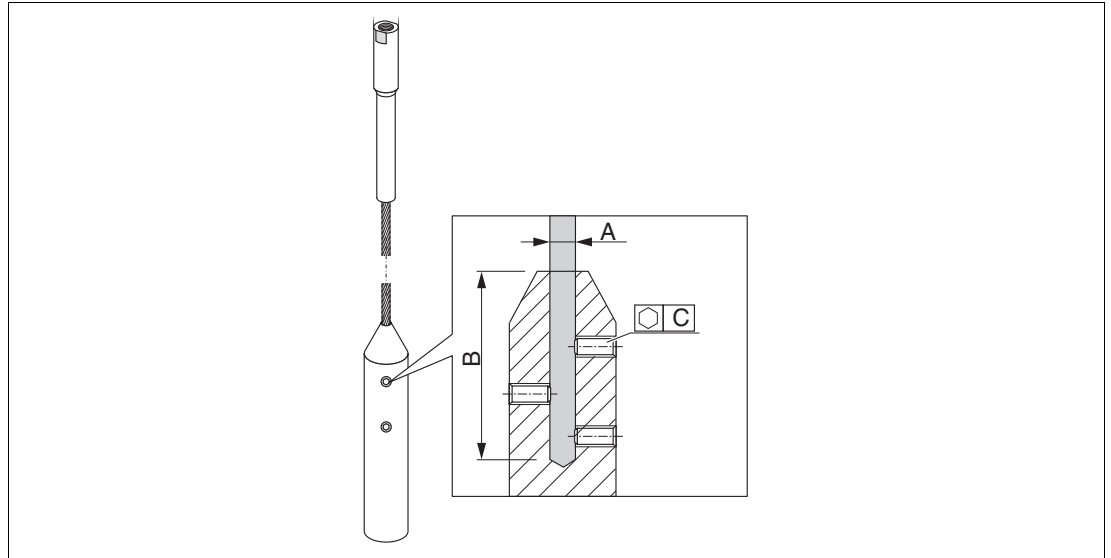

Figure 6.18

Rope material	A	B	C	Torque for set screws
316	4 mm (0.16 in)	40 mm (1.6 in)	3 mm	5 Nm (3.69 lbf ft)
316	6 mm (0.24 in)	55 mm (2.2 in)	4 mm	15 Nm (11.06 lbf ft)
PA > steel	6 mm (0.24 in)	40 mm (1.6 in)	3 mm	5 Nm (3.69 lbf ft)
PA > steel	8 mm (0.31 in)	55 mm (2.2 in)	4 mm	15 Nm (11.06 lbf ft)

Table 6.5



Shortening rope probes

- Using an Allen key, loosen the set screws at the end-of-probe weight.
Note: The set screws have got a clamping coating in order to prevent accidental loosening. Thus an increased torque might be necessary to loosen them.
- Remove released rope from the weight.
- Measure off new rope length.
- Wrap adhesive tape around the rope at the point to be shortened to prevent it from fanning out.
- Saw off the rope at a right angle or cut it off with a bolt cutter.
- Insert the rope completely into the weight.
- Screw the set screws into place. Due to the clamping coating of the setscrews application of a screw locking fluid is not necessary.

6.2.3 Mounting the device

Mounting devices with thread

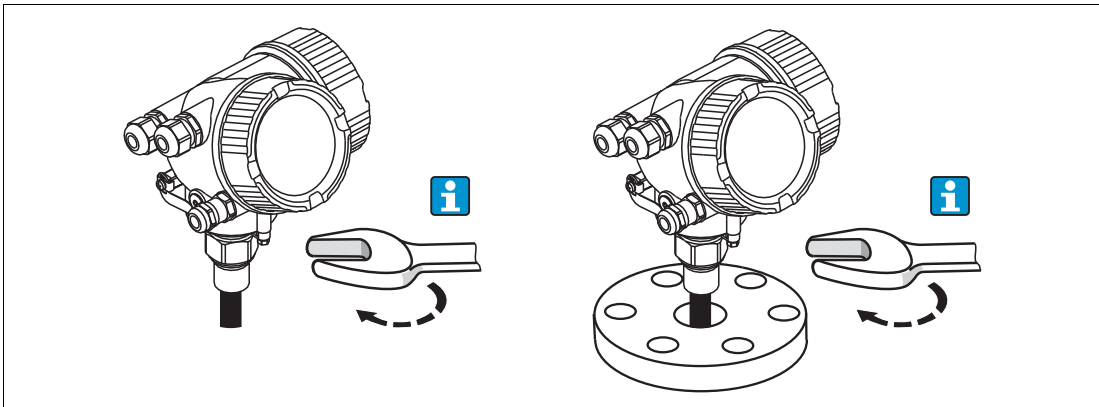

Figure 6.19

Devices with mounting thread are screwed into a welding boss or a flange and are usually also secured with these.



Note!

- Tighten with the hexagonal nut only:
 - Thread 3/4 in: Hexagonal wrench 36 mm
 - Thread 1-1/2 in: Hexagonal wrench 55 mm
- Maximum permissible torque:
 - Thread 3/4 in: 45 Nm
 - Thread 1-1/2 in: 450 Nm
- Recommended torque when using the supplied aramid fibre seal and a process pressure of 40 bar (580 psi):
 - Thread 3/4 in: 25 Nm
 - Thread 1-1/2 in: 140 Nm
- When installing in metal containers, take care to ensure good metallic contact between the process connection and container.

Flange mounting

If a seal is used, be sure to use unpainted metal bolts to ensure good electrical contact between probe flange and process flange.

Mounting rope probes



Warning!

Electrostatic discharges may damage the electronics.

- Earth the housing before lowering the rope into the vessel.

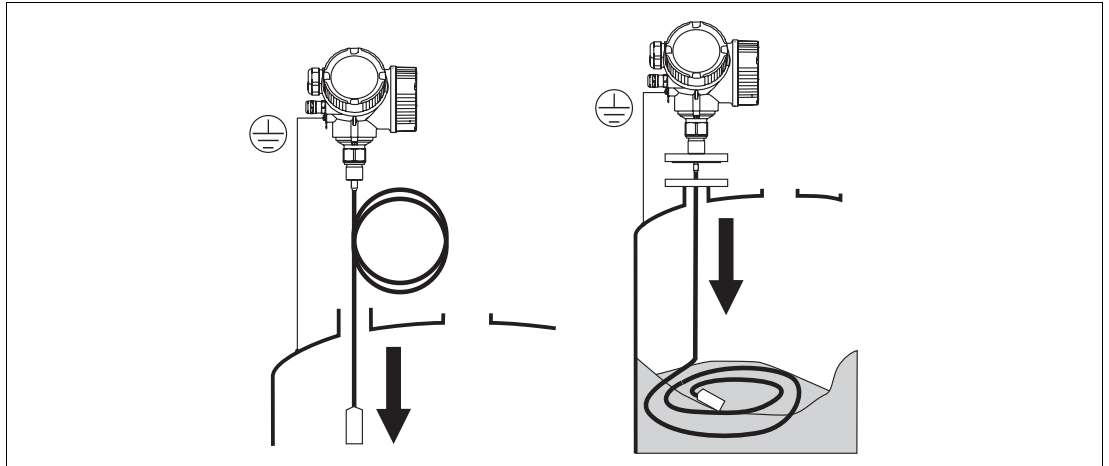

Figure 6.20

When lowering the rope probe into the vessel, observe the following:

- Uncoil rope and lower it slowly and carefully into the vessel.
- Do not kink the rope.
- Avoid any backlash, since this might damage the probe or the vessel fittings.



Note!

Mounting rope probes in a partially full silo

It is not always possible to empty a silo which is already in operation. If a minimum of 2/3 of the silo is empty, it is possible to install the probe into the partially filled silo. If possible, make a visual check after the installation to see that the rope has not tangled or is lying such that it can knot when the level falls. Before full accuracy is obtained the probe rope must hang fully extended.

6.2.4 Mounting the "Sensor remote" version



Note!

This section is only valid for devices of the version "Probe design" = "Sensor remote" (feature "Probe design", option B).

For the version "Probe design = Sensor remote" the following is supplied:

- The probe with the process connection
- The electronics housing
- The mounting bracket for wall or pipe mounting of the electronics housing
- The connection cable (length as ordered). The cable has got one straight and one angled plug (90°). Depending on the local conditions the angled plug can be connected at the probe or at the electronics housing.



Warning!

The plugs of the connection cable may be damaged by mechanical stress.

- Mount the probe and the electronics housing tightly before connecting the cable.
- Lay the cable such that it is not exposed to mechanical stress. Minimum bending radius: 100 mm (4 in).
- When connecting the cable: Connect the straight plug before the angled one. Torque for both coupling nuts: 6 Nm.



Note!

If the measuring point is exposed to strong vibrations, an additional locking compound (e. g. Loctite 243) can be applied at the plug connectors.

Mounting the electronics housing

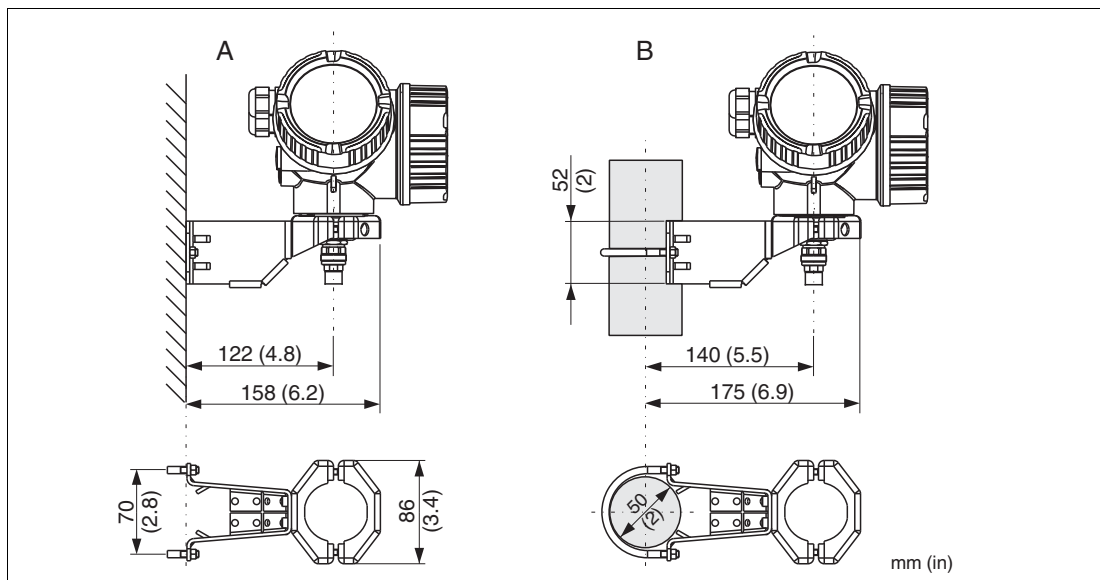

Figure 6.21

- A** Wall mounting
- B** Pipe mounting

Connecting the cable

Required tools: open-end wrench AF18

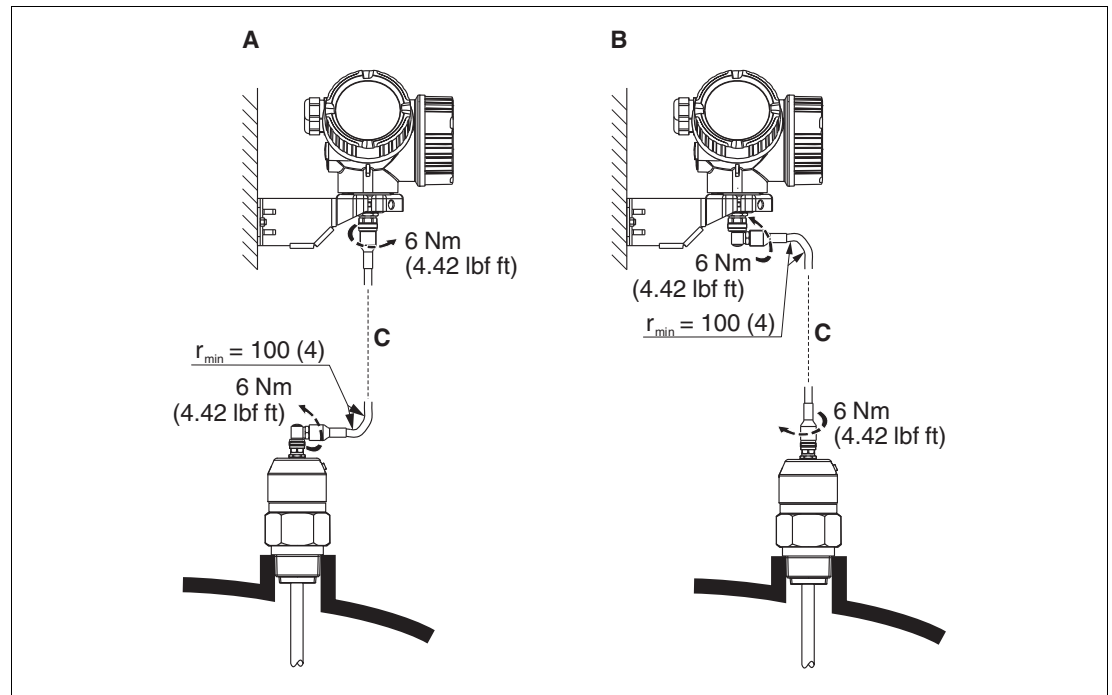

Figure 6.22

- A** Angled plug at the probe
- B** Angled plug at the electronics housing
- C** Length of the remote cable as ordered

6.2.5 Turning the transmitter housing

To provide easier access to the connection compartment or display module, the transmitter housing can be turned:

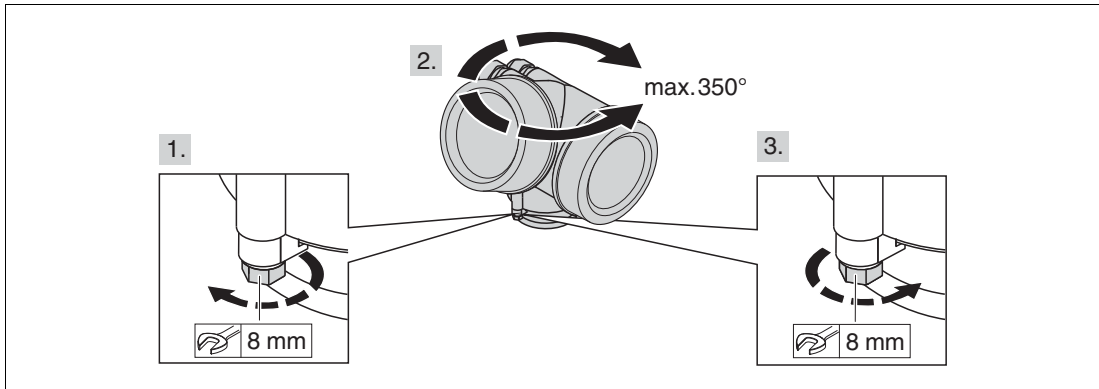

Figure 6.23

Turning the transmitter housing

1. Unscrew the securing screw using an open-ended wrench.
2. Rotate the housing in the desired direction.
3. Tighten the securing screw (1.5 Nm for plastics housing; 2.5 Nm for aluminium or stainless steel housing).

6.2.6 Turning the display module

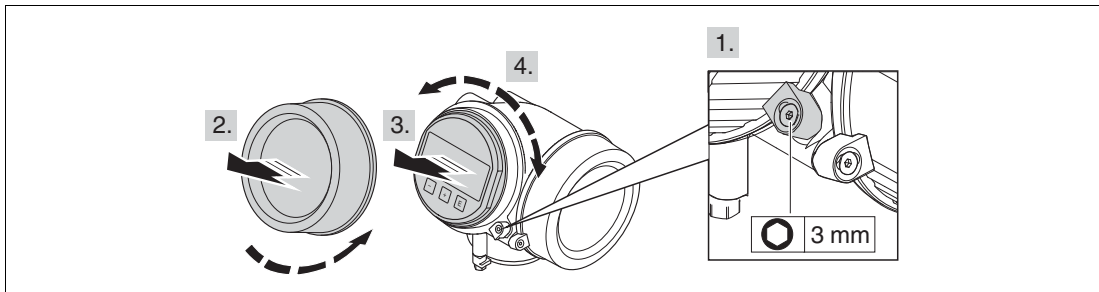

Figure 6.24

Turning the display module

1. If present: Loosen the screw of the securing clamp of the electronics compartment cover using an Allen key and turn the clamp 90° counterclockwise.
2. Unscrew cover of the electronics compartment from the transmitter housing.
3. Pull out the display module with a gentle rotation movement.
4. Rotate the display module into the desired position: Max. 8 x 45° in each direction.
5. Feed the spiral cable into the gap between the housing and main electronics module and plug the display module into the electronics compartment until it engages.
6. Screw the cover of the electronics compartment firmly back onto the transmitter housing.
7. Tighten the securing clamp again using the Allen key (torque: 2.5 Nm).



6.3

Post-installation check

- Is the device undamaged (visual inspection)?
- Does the device conform to the measuring point specifications?
For example:
 - Process temperature
 - Process pressure
 - Ambient temperature range
 - Measuring range
- Are the measuring point identification and labeling correct (visual inspection)?
- Is the device adequately protected from precipitation and direct sunlight?
- Are the securing screw and securing clamp tightened securely?

7 Electrical connection

7.1 Connection conditions

7.1.1 Terminal assignment

PROFIBUS PA

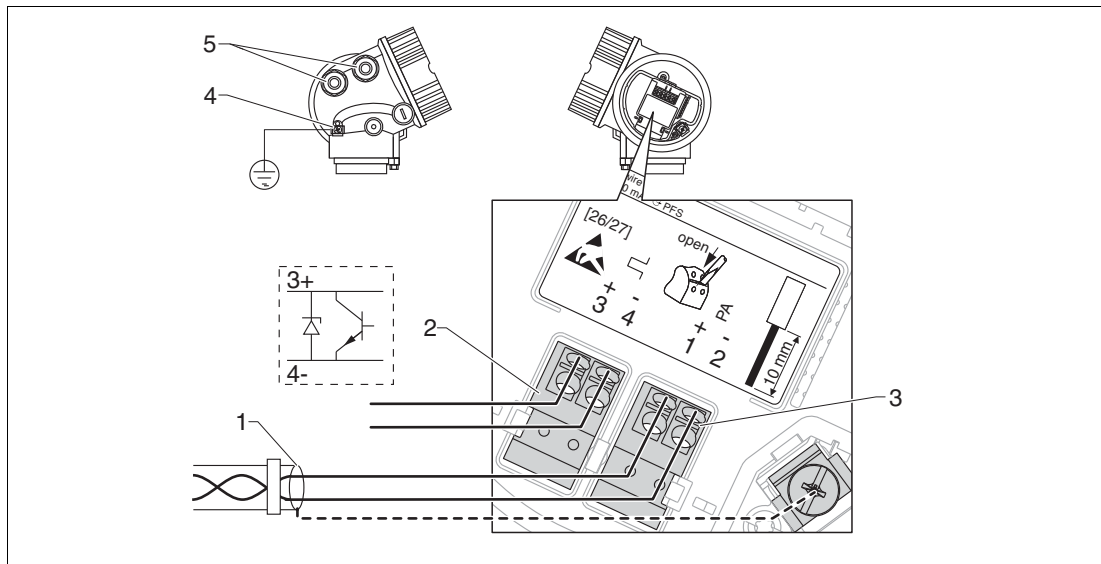

Figure 7.1 Terminal assignment PROFIBUS PA

- 1 Cable screen: observe cable specifications
- 2 Switch output (open collector): terminals 3 and 4
- 3 Connection PROFIBUS PA: terminals 1 and 2
- 4 Terminal for potential equalization line
- 5 Cable entries

Connection examples for the switch output

 <p>Connection of a relay Suitable relays (examples):</p> <ul style="list-style-type: none"> • Solid-state relay: Phoenix Contact OV-24DC/480AC/5 with mounting rail connector UMK-1 OM-R/AMS • Electromechanical relay: Phoenix Contact PLC-RSC-12DC/21 	 <p>Connection of a digital input</p> <ol style="list-style-type: none"> 1 Pull-up resistor 2 Digital input
---	--

Table 7.1



Note!

For optimum interference immunity we recommend to connect an external resistor (internal resistance of the relay or Pull-up resistor) of < 1000 Ω.

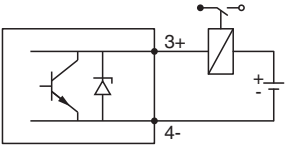
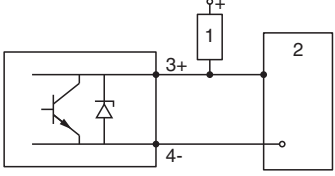
7.1.2

Cable specification

- Minimum cross-section: See the terminal specification in the Technical Information for the device.
- For ambient temperature $T_{amb} \geq 60 \text{ °C}$ (140 °F): use cable for temperature $T_{amb} + 20 \text{ K}$.

PROFIBUS PA

- Use a twisted, screened two-wire cable, preferably cable type A.



Note!

For further information on the cable specifications, see PNO Guideline 2.092 "PROFIBUS PA User and Installation Guideline" and IEC 61158-2 (MBP).

7.1.3 Device plug connectors



Note!

For the versions with fieldbus plug connector (M12 or 7/8 in), the signal line can be connected without opening the housing.

Pin assignment of the M12 plug connector

	Pin	Meaning
	1	Signal +
	2	not connected
	3	Signal -
	4	Ground

Table 7.2

Pin assignment of the 7/8 in plug connector

	Pin	Meaning
	1	Signal -
	2	Signal +
	3	not connected
	4	Screen

Table 7.3

7.1.4 Power supply

PROFIBUS PA

Electrical Output ^a	Approval ^b	Terminal voltage
PA: 2-wire; PROFIBUS PA, switch output	<ul style="list-style-type: none"> • Non-Ex • Ex nA • Ex nA(ia) • Ex ic • Ex ic(ia) • Ex d(ia)/XP • Ex ta/DIP • CSA GP 	9 ... 32 V ^c
	<ul style="list-style-type: none"> • Ex ia/IS • Ex ia + Ex d(ia)/IS + XP 	9 ... 30 V ^d

Table 7.4

^a Feature "Electrical Output" the product structure

^b Feature "Approval" of the product structure

^c Input voltages up to 35 V will not spoil the device.

^d Input voltages up to 35 V will not spoil the device.

Polarity sensitive	no
FISCO/FNICO compliant according to IEC 60079-27	yes

Table 7.5



7.1.5 **Overvoltage protection**

If the measuring device is used for level measurement in flammable liquids which requires the use of overvoltage protection according to DIN EN 60079-14, standard for test procedures 60060-1 (10 kA, pulse 8/20 μ s), overvoltage protection has to be ensured by an external overvoltage protection module.

External overvoltage protection

For detailed information please refer to www.pepperl-fuchs.com

7.2 Connecting the device



Warning!

Explosion hazard!

- Comply with the relevant national standards.
- Observe the specifications in the Safety Instructions (SI).
- Only use the specified cable glands.
- Check whether the supply voltage matches the specifications on the nameplate.
- Before connecting the device: Switch the supply voltage off.
- Before switching on the supply voltage: Connect the potential bonding line to the exterior ground terminal.

Required tools and accessories:

- For instruments with safety pin for the lid: AF3 Allen key
- Wire stripping pliers
- When using stranded wires: wire end sleeves.

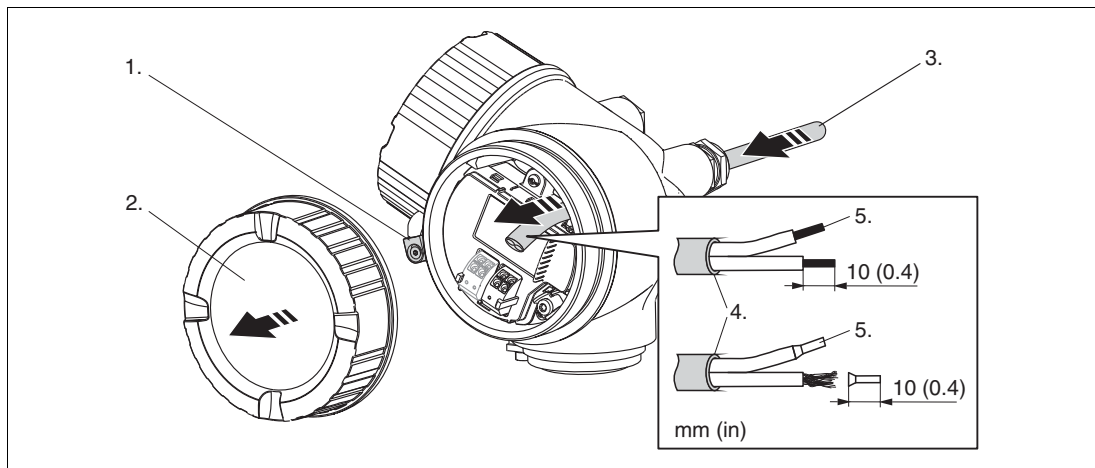

Figure 7.2

▶ Connecting the device

1. Loosen the screw of the securing clamp of the connection compartment cover and turn the clamp 90° counterclockwise.
2. Unscrew the connection compartment cover.
3. Push the cable through the cable entry. To ensure tight sealing, do not remove the sealing ring from the cable entry.
4. Strip the cable.
5. Strip the cable ends 10 mm (0.4 in). For stranded cables, also attach wire end ferrules.
6. Firmly tighten the cable glands.

7. Connect the cable in accordance with the terminal assignment. See chapter 7.1.1.

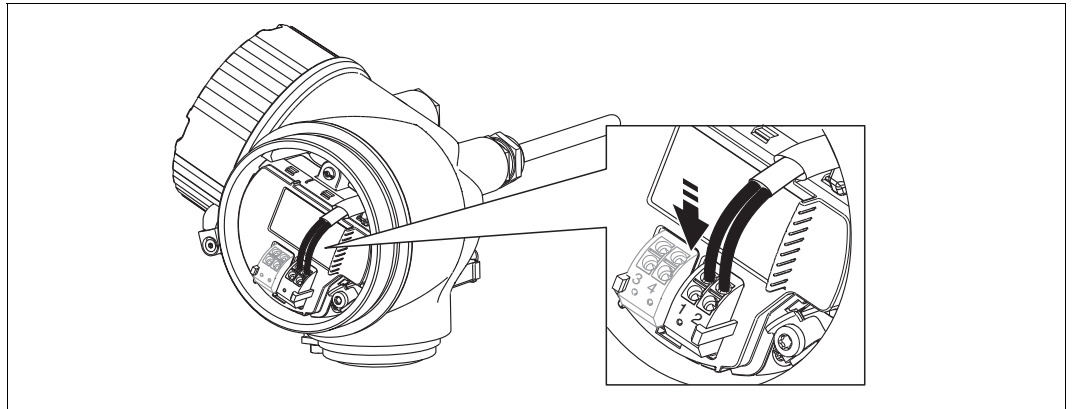

Figure 7.3

8. When using screened cable: Connect the cable screen to the ground terminal.
9. Screw the cover onto the connection compartment.
10. For instruments with safety pin for the lid: Adjust the safety pin so that its edge is over the edge of the display lid. Tighten the safety pin.

Pluggable spring-force terminals

Instruments have pluggable spring-force terminals. Rigid conductors or flexible conductors with cable sleeve can directly be inserted and are contacted automatically.

To remove cables from the terminal: Press on the groove between the terminals using a flat-tip screwdriver ≤ 3 mm (0.12 in) while pulling the cables out of the terminals.

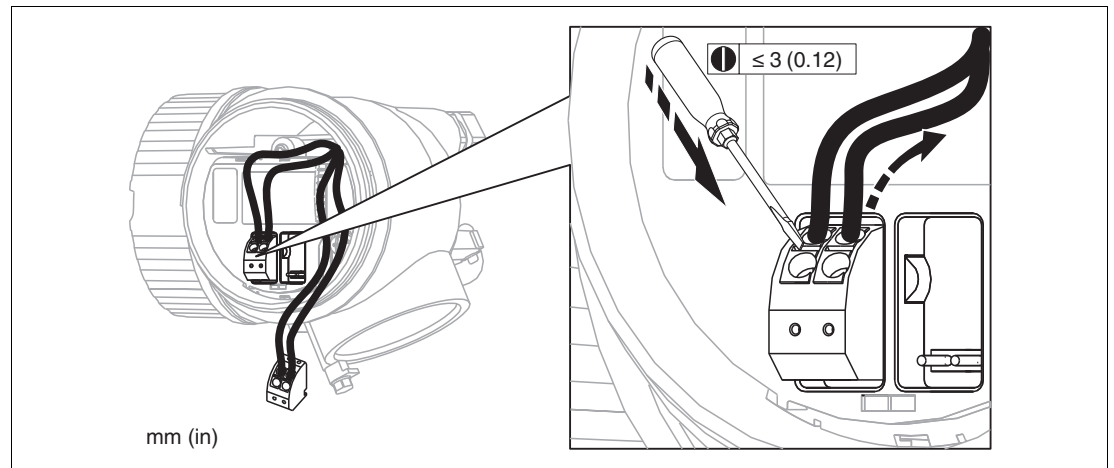

Figure 7.4



7.3

Post-connection check

- Are cables or the device undamaged (visual inspection)?
- Do the cables comply with the requirements?
- Do the cables have adequate strain relief?
- Are all cable glands installed, firmly tightened and correctly sealed?
- Does the supply voltage match the specifications on the transmitter nameplate?
- Is the terminal assignment correct? See chapter 7.1.1.
- If required: Is the protective earth connected correctly? See chapter 7.1.1.
- If supply voltage is present: Is the device ready for operation and do values appear on the display module?
- Are all housing covers installed and firmly tightened?
- Is the securing clamp tightened correctly?



8 Operating options

8.1 Overview

8.1.1 Local operation

Order code for "Display, operation", option D "SD02"		Order code for "Display, operation", option E "SD03"	
			
1	Operation with push buttons	1	Operation with touch control

Table 8.1

8.1.2 Remote operation

Via PROFIBUS PA protocol

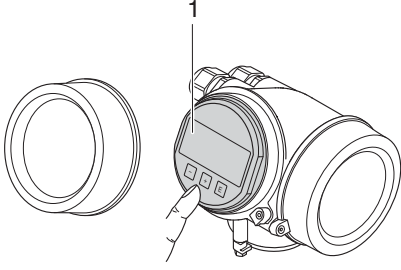
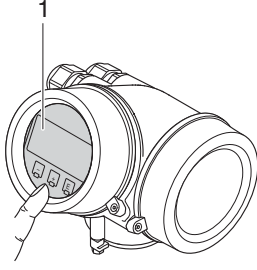
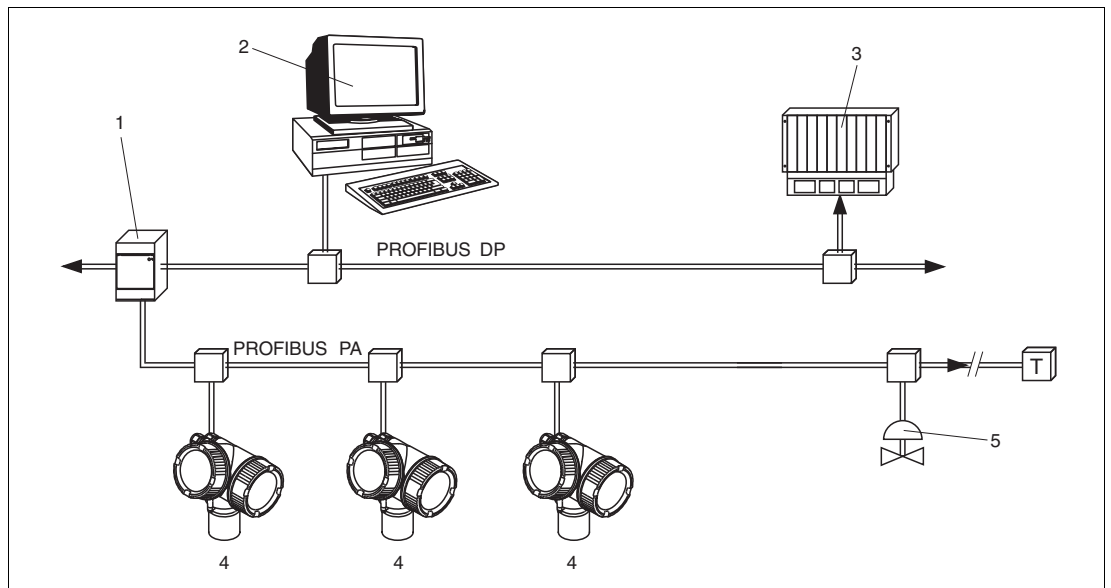

Figure 8.1

- 1 Segment coupler
- 2 Computer with Profiboard/Proficard and operating tool (e. g. PACTware)
- 3 PLC (Programmable Logic Controller)
- 4 Transmitter
- 5 Additional functions (valves etc.)



Via service interface (CDI)

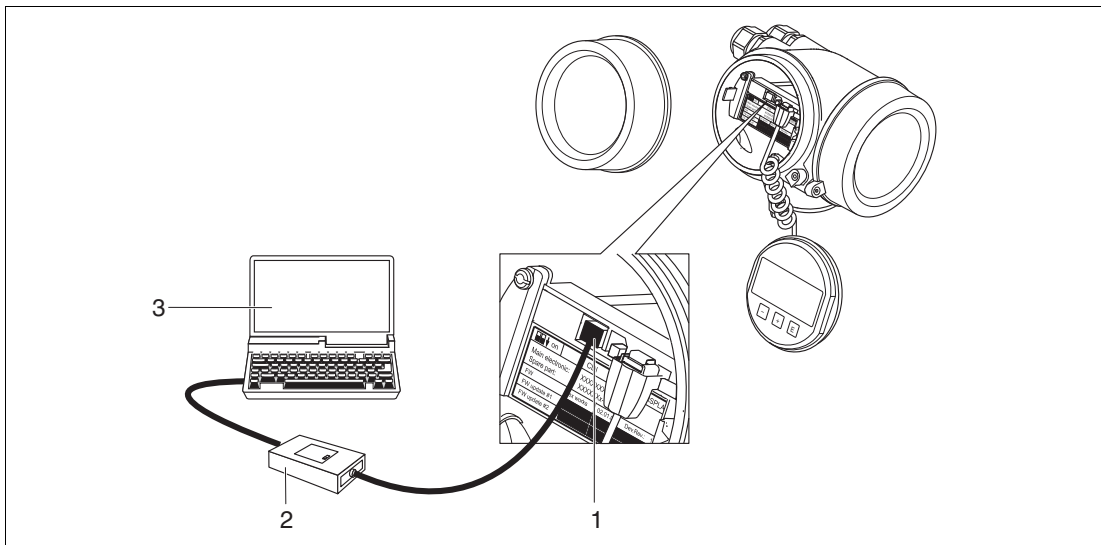

Figure 8.2

- 1 Service interface (CDI) of the measuring device (Common Data Interface)
- 2 Modem
- 3 Computer with PACTware operating tool

8.2 Structure and function of the operating menu

8.2.1 Structure of the operating menu

Menu	Parameter/submenu	Meaning
	Language parameter ^a	Defines the operating language of the on-site display.
Setup	Parameter 1 ... Parameter N	When all these parameters have been assigned appropriate values, the measured should be completely configured in a standard application.
	Advanced setup	Contains further submenus and parameters: <ul style="list-style-type: none"> to adapt the device to special measuring conditions. to process the measured value (scaling, linearization). to configure the signal output.
Diagnostics	Diagnostic list	Contains up to 5 currently active error messages.
	Event logbook ^b	Contains the last 20 messages (which are no longer active).
	Device information	Contains information needed to identify the device.
	Measured values	Contains all current measured values.
	Data logging	Contains the history of the individual measuring values.
	Simulation	Used to simulate measured values or output values.
	Device check	Contains all parameters needed to check the measurement capability of the device.
Expert. ^c Contains all parameters of the device (including those which are already contained in one of the above submenus). This menu is organized according to the function blocks of the device.	System	Contains all general device parameters which do not affect the measurement or the communication interface.
	Sensor	Contains all parameters needed to configure the measurement.
	Output	<ul style="list-style-type: none"> Contains all parameters needed to configure the current output. Contains all parameters needed to configure the switch output (PFS).
	Communication	Contains all parameters needed to configure the digital communication interface.
	Diagnostics	Contains all parameters needed to detect and analyze operational errors.

Table 8.2

^a In case of operation via operating tools (e. g. PACTware), the **Language** parameter is located at Setup → Advanced setup → Display.

^b Only available for operation via on-site display.

^c On entering the **Expert** menu, an access code is always requested. If a customer specific access code has not been defined, **0000** has to be entered.



8.2.2 User roles and related access authorization

The two user roles **Operator** and **Maintenance** have different write access to the parameters if a device-specific access code has been defined. This protects the device configuration via the local display from unauthorized access.

Access authorization to parameters

User role	Read access		Write access	
	Without access code (from the factory)	With access code	Without access code (from the factory)	With access code
Operator	x	x	x	–
Maintenance	x	x	x	x

Table 8.3

If an incorrect access code is entered, the user obtains the access rights of the **Operator** role.



Note!

The user role with which the user is currently logged on is indicated by the **Access status display** (for display operation) or **Access status tooling** (for tool operation).

8.2.3 Write protection via access code

Using the device-specific access code, the parameters for the measuring device configuration are write-protected and their values can no longer be changed via local operation.



Define access code via local display

1. Navigate to: Setup → Advanced setup → Administration → Define access code → Define access code
2. Define a max. 4-digit numeric code as an access code.
3. Repeat the same code in **Confirm access code** parameters.
 - ↳ The  symbol appears in front of all write-protected parameters.



Define access code via operating tool (e. g. PACTware)

1. Navigate to: Setup → Advanced setup → Administration → Define access code
2. Define a max. 4-digit numeric code as an access code.
 - ↳ Write protection is active.

Parameters that can always be changed

The write protection does not include certain parameters that do not affect the measurement. Despite the defined access code, they can always be modified, even if the other parameters are locked.

If no key is pressed for 10 minutes in the navigation and editing mode, the device automatically locks the write-protected parameters. If the user goes from the navigation and editing mode back to the measured value display mode, the device automatically locks the write-protected parameters after 60 s.



Note!

- If write access is activated via access code, it can be also be deactivated only via the access code.
- In the "Description of Device Parameters" documents, each write-protected parameter is identified with the  symbol.

8.2.4 Disabling write protection via access code

If the  symbol appears on the local display in front of a parameter, the parameter is write-protected by a device-specific access code and its value cannot be changed at the moment using the local display.



Disabling write protection

The locking of the write access via local operation can be disabled by entering the device-specific access code.

1. After you press , the input prompt for the access code appears.
2. Enter the access code.

↳ The  symbol in front of the parameters disappears; all previously write-protected parameters are now re-enabled.



8.2.5 Deactivation of the write protection via access code



Deactivating write protection via local display

1. Navigate to: Setup → Advanced setup → Administration → Define access code → Define access code
2. Enter **0000**.
3. Repeat **0000** in **Confirm access code** parameter.
↳ The write protection is deactivated. Parameters can be changed without entering an access code.



Deactivating write protection via operating tool (e. g. PACTware)

1. Navigate to: Setup → Advanced setup → Administration → Define access code
2. Enter **0000**.
↳ The write protection is deactivated. Parameters can be changed without entering an access code.

8.2.6 Write protection via lock switch

Unlike write protection via a user-specific access code, this allows write access to the entire operating menu – other than the **Contrast display** parameter – to be locked.

The parameter values are now read only and cannot be edited any more (exception **Contrast display** parameter) via:

- local display
- PROFIBUS PA protocol

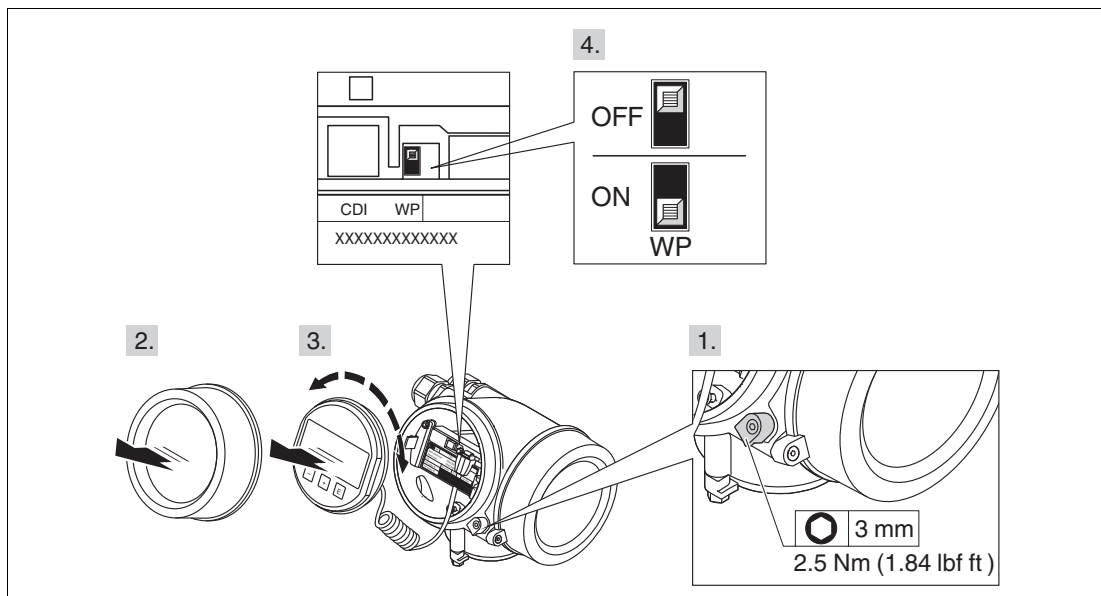

Figure 8.3



Setting write protection via lock switch

1. Loosen the securing clamp.
2. Unscrew the electronics compartment cover.
3. Pull out the display module with a gentle rotation movement. To make it easier to access the lock switch, attach the display module to the edge of the electronics compartment.

↳ Display module is attached top the edge of the electronics compartment.

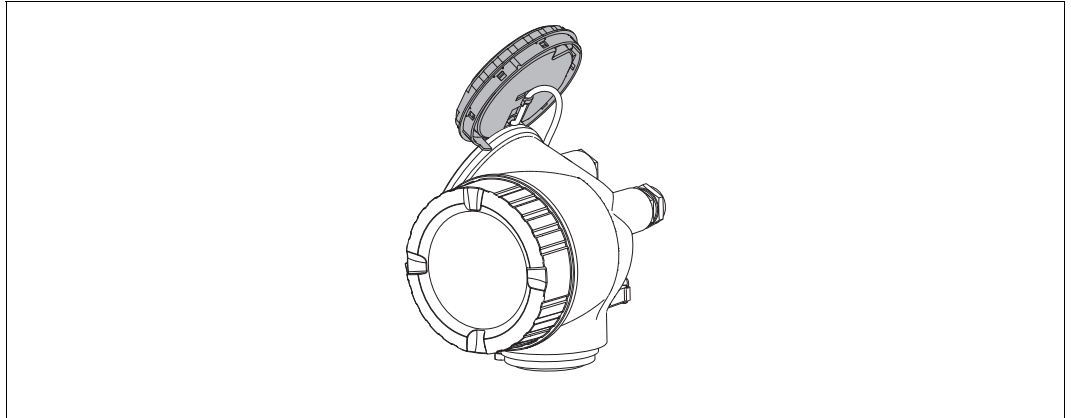



Figure 8.4

4. Set the lock switch (WP) on the main electronics module in the **ON** position enables the hardware write protection. Set the lock switch (WP) on the main electronics module in the **OFF** position (factory setting) disables the hardware write protection.

↳ If the hardware write protection is enabled: The **Hardware locked** option is displayed in the **Locking status** parameter. In addition to this, the  symbol appears in the header of the measured value display and in the navigation view in front of the parameters.

↳ If the hardware write protection is disabled: No option is displayed in the **Locking status** parameter. The  symbol disappears in the header of the measured value display and in the navigation view in front of the parameters

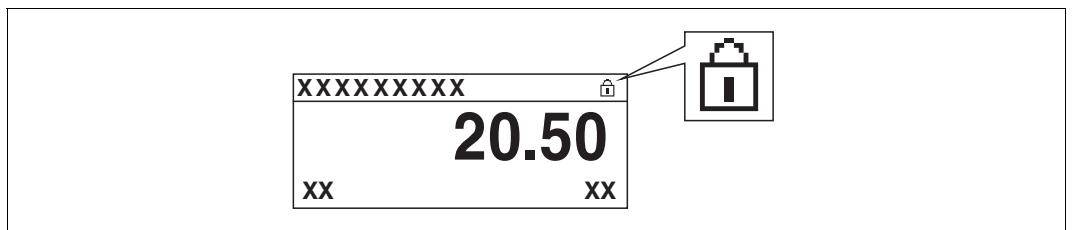

Figure 8.5

5. Feed the spiral cable into the gap between the housing and main electronics module and plug the display module into the electronics compartment in the desired direction until it engages.
6. Screw the electronics compartment cover closed and tighten the securing clamp.



8.2.7 Enabling and disabling the keypad lock

The keypad lock allows you to disable access to the entire operating menu via local operation. Thus navigating through the operating menu or modifying the values of individual parameters is no longer possible. Only the measured values on the measured value display can be read off.

The keylock is enabled and disabled via a context menu.

Enabling the keylock



Note!

SD03 display module only

The keylock is automatically enabled:

- after each restart of the device
- if the device is in the measured value display mode and has not been operated for at least one minute.



Enabling the keylock manually

The device is in the measured value display mode.

1. Press the  key for at least two seconds.
 - ↳ A context menu appears.
2. Select the **Keylock on** option from the context menu.
 - ↳ The keylock is enabled.



Note!

When attempting to access the operating menu while the keylock is enabled, the **Keylock on** message appears.



Disabling the keylock

The keylock is enabled.

1. Press the  key for at least two seconds.
 - ↳ A context menu appears.
2. Select the **Keylock off** option from the context menu.
 - ↳ The keylock is disabled.

8.3 Display and operating module

8.3.1 Display appearance

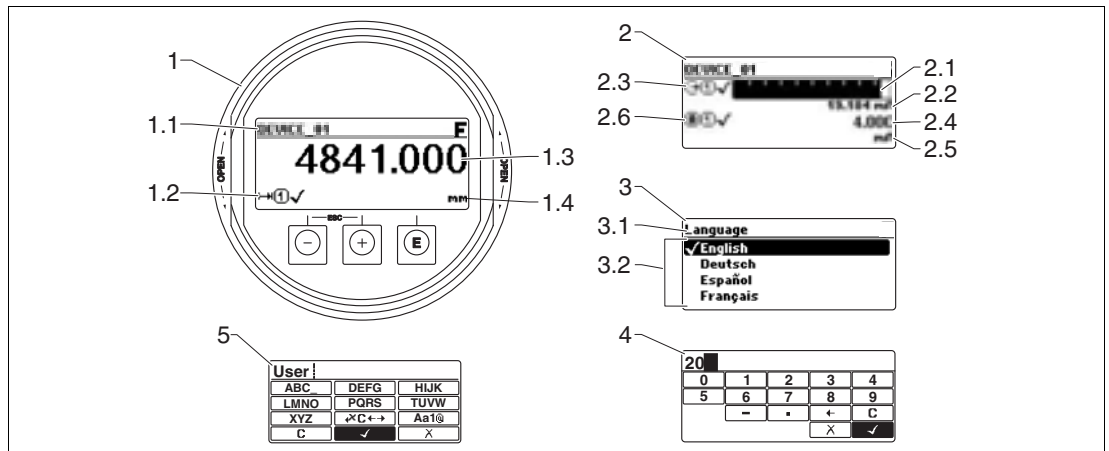

Figure 8.6 Appearance of the display and operation module for on-site operation

- 1 Measured value display (1 value max. size)
- 1.1 Header containing tag and error symbol (if an error is active)
- 1.2 Measured value symbols
- 1.3 Measured value
- 1.4 Unit
- 2 Measured value display (1 bargraph and 1 value)
- 2.1 Bargraph for measured value 1
- 2.2 Measured value 1 (including unit)
- 2.3 Measured value symbols for measured value 1
- 2.4 Measured value 2
- 2.5 Unit for measured value 2
- 2.6 Measured value symbols for measured value 2
- 3 Representation of a parameter (here: a parameter with selection list)
- 3.1 Header containing parameter name and error symbol (if an error is active)
- 3.2 Selection list; marks the current parameter value.
- 4 Input matrix for numbers
- 5 Input matrix for alphanumeric and special characters

Display symbols for the submenus





Symbol	Meaning
	Display/operation Is displayed: <ul style="list-style-type: none"> in the main menu next to the selection Display/operation in the header, if you are in the Display/operation menu
	Setup Is displayed: <ul style="list-style-type: none"> in the main menu next to the selection Setup in the header, if you are in the Setup menu
	Expert Is displayed: <ul style="list-style-type: none"> in the main menu next to the selection Expert in the header, if you are in the Expert menu
	Diagnostics Is displayed: <ul style="list-style-type: none"> in the main menu next to the selection Diagnostics in the header, if you are in the Diagnostics menu

Table 8.4

Status signals





	Failure (F) A device error is present. The measured value is no longer valid.
	Function check (C) The device is in service mode (e. g. during a simulation).
	Out of specification (S) The device is operated: <ul style="list-style-type: none"> outside of its technical specifications (e. g. during startup or a cleaning) outside of the configuration carried out by the user (e. g. level outside configured span)
	Maintenance required (M) Maintenance is required. The measured value is still valid.

Table 8.5

Display symbols for the locking state



Symbol	Meaning
	Display parameter Marks display-only parameters which can not be edited.
	Device locked <ul style="list-style-type: none"> In front of a parameter name: The device is locked via software and/or hardware. In the header of the measured value screen: The device is locked via hardware.

Table 8.6

Measured value symbols











Symbol	Meaning
Measured values	
	Level
	Distance
	Current output
	Measured current
	Terminal voltage
	Temperature of the electronics or the sensor
Measuring channels	
	Measuring channel 1
	Measuring channel 2
Status of the measured value	
	Status "Alarm" The measurement is interrupted. The output assumes the defined alarm value. A diagnostic message is generated.
	Status "Warning" The device continues measuring. A diagnostic message is generated.

Table 8.7

8.3.2 Operating elements





Key	Meaning
	<p>Minus key For menu, submenu Moves the selection bar upwards in a picklist. For text and numeric editor In the input mask, moves the selection bar to the left (backwards).</p>
	<p>Plus key For menu, submenu Moves the selection bar downwards in a picklist. For text and numeric editor In the input mask, moves the selection bar to the right (forwards).</p>
	<p>Enter key For measured value display</p> <ul style="list-style-type: none"> Pressing the key briefly opens the operating menu. Pressing the key for 2 s opens the context menu. <p>For menu, submenu</p> <ul style="list-style-type: none"> Pressing the key briefly Opens the selected menu, submenu or parameter. Pressing the key for 2 s for parameter If present, opens the help text for the function of the parameter. <p>For text and numeric editor.</p> <ul style="list-style-type: none"> Pressing the key briefly <ul style="list-style-type: none"> Opens the selected group. Carries out the selected action. Pressing the key for 2 s confirms the edited parameter value.
	<p>Escape key combination (press keys simultaneously) For menu, submenu</p> <ul style="list-style-type: none"> Pressing the key briefly <ul style="list-style-type: none"> Exits the current menu level and takes you to the next higher level. If help text is open, closes the help text of the parameter. Pressing the key for 2 s returns you to the measured value display ("home position"). <p>For text and numeric editor Closes the text or numeric editor without applying changes.</p>
	<p>Minus/Enter key combination (press and hold down the keys simultaneously) Reduces the contrast (brighter setting).</p>
	<p>Plus/Enter key combination (press and hold down the keys simultaneously) Increases the contrast (darker setting).</p>
	<p>Minus/Plus/Enter key combination (press and hold down the keys simultaneously) For measured value display Enables or disables the keypad lock.</p>

Table 8.8

8.3.3 Entering numbers and text

Numeric editor	Text editor
<p>1 2 3 4</p>	<p>Editing view Display area of the entered values Input mask Operating elements</p>

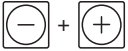
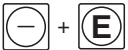
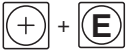
Table 8.9

Input mask

The following input symbols are available in the input mask of the numeric and text editor:

Numeric editor

Symbol	Meaning
	Selection of numbers from 0 to 9.
	Inserts decimal separator at the input position.
	Inserts minus sign at the input position.
	Confirms selection.
	Moves the input position one position to the left.
	Exits the input without applying the changes.
	Clears all entered characters.

Table 8.10



Text editor









Symbol	Meaning
  	Selection of letters from A to Z
	Toggle <ul style="list-style-type: none"> • between upper-case and lower-case letters • for entering numbers • for entering special characters
	Confirms selection.
	Switches to the selection of the correction tools.
	Exits the input without applying the changes.
	Clears all entered characters.

Table 8.11

Text correction via 





Symbol	Meaning
	Clears all entered characters.
	Moves the input position one position to the right.
	Moves the input position one position to the left.
	Deletes one character immediately to the left of the input position.

Table 8.12



8.3.4 Opening the context menu

Using the context menu, the user can call up the following menus quickly and directly from the operational display:

- Setup
- Conf. backup disp.
- Simulation



Calling up and closing the context menu

The user is in the operational display.

1. Press **⏏** for 2 s.

↳ The context menu opens.

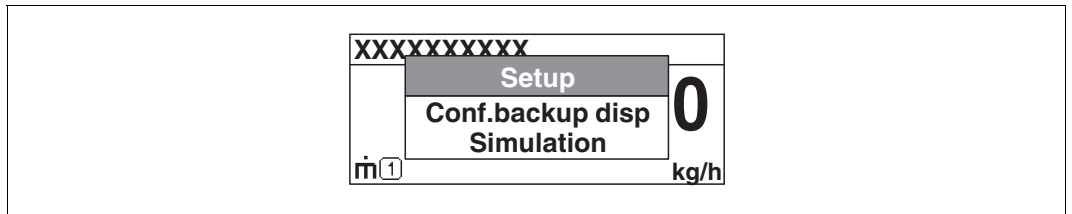

Figure 8.7

2. Press **⏏** and **⏏** simultaneously.

↳ The context menu is closed and the operational display appears.



Calling up the menu via the context menu

1. Open the context menu.
2. Press **⏏** to navigate to the desired menu.
3. Press **⏏** to confirm the selection.

↳ The selected menu opens.



8.3.5 Envelope curve on the display and operating module

In order to assess the measuring signal, the envelope curve and – if a mapping has been recorded – the mapping curve can be displayed:

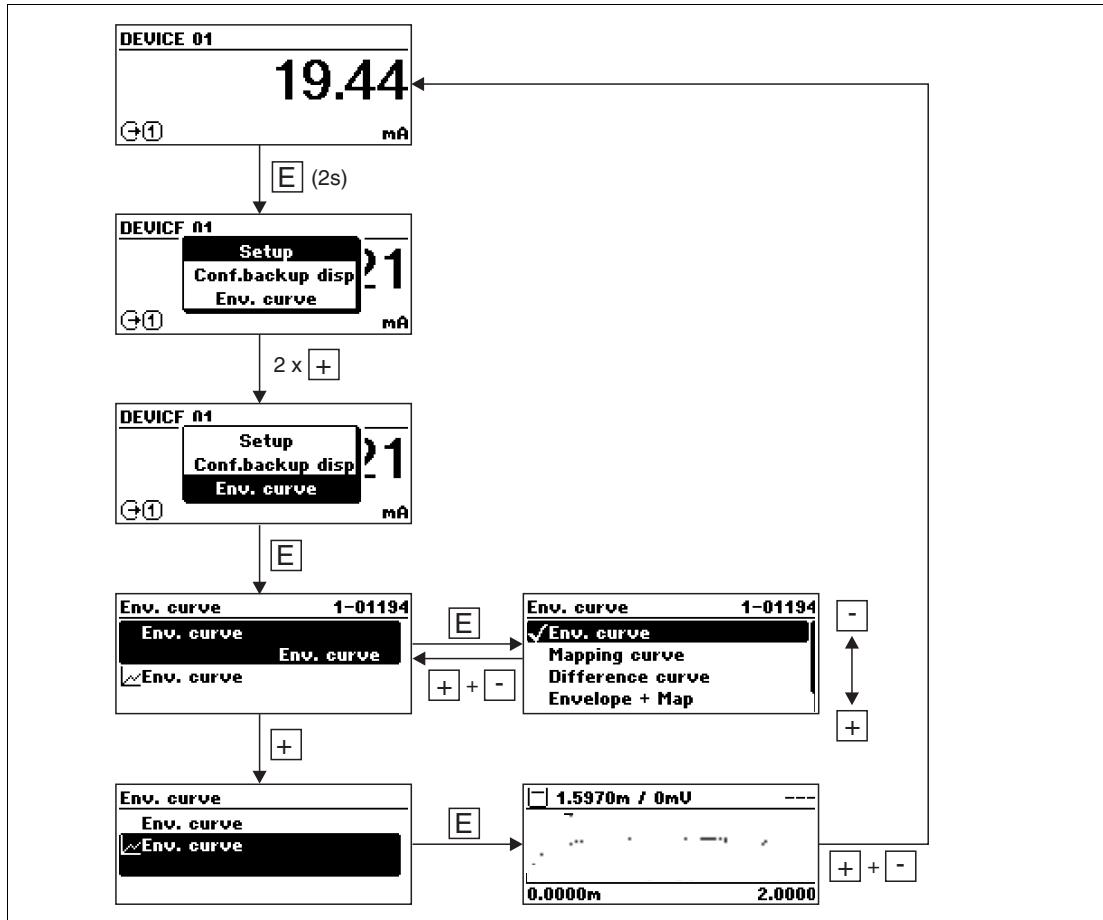

Figure 8.8

9 Integration into a PROFIBUS network

9.1 Overview of the device database files (GSD)

Manufacturer ID	93 (5D HEX)
Ident number	0E3B HEX
Profil version	3.02
GSD file	Information and files under: <ul style="list-style-type: none"> • www.pepperl-fuchs.com • www.profibus.org
GSD file version	

Table 9.1

9.2 Set device address

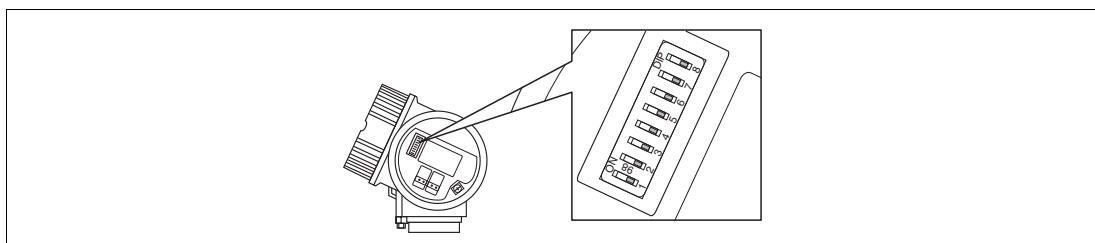

Figure 9.1 Address switches in terminal compartment

9.2.1 Hardware addressing



Setting hardware addressing

1. Set switch 8 to **OFF**.
2. Define the address with switches 1 to 7 according to the table below.

↳ The address change becomes effective after 10 seconds. The device restarts automatically.

Switch	1	2	3	4	5	6	7
Value in position ON	1	2	4	8	16	32	64
Value in position OFF	0	0	0	0	0	0	0

Table 9.2

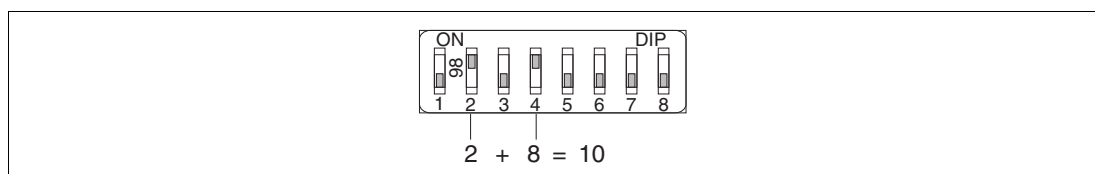

Figure 9.2 Example of hardware addressing: switch 8 is in position **OFF**; switches 1 to 7 define the address.



9.2.2

Software addressing



Setting software addressing

1. Set switch 8 to **ON**.
2. The device restarts automatically. The address remains the same as before (factory setting: 126).
3. Set the required address via the operating menu: Setup → Device address

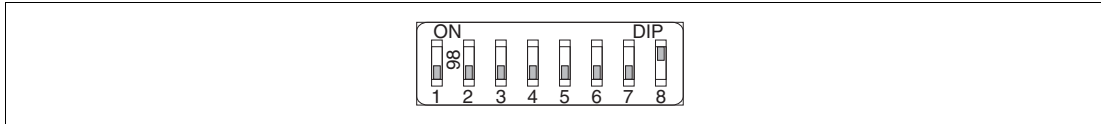

Figure 9.3 Example of software addressing; switch 8 is in position **ON**; the address is defined in the operating menu (Menu Setup → Device address)

10 Commissioning (via operating menu)

10.1 Installation and function check

Make sure that all final checks have been completed before you start up your measuring point:

- Checklist "Post-installation check", see chapter chapter 6
- Checklist "Post-connection check", see chapter chapter 7.2

10.2 Setting the operating language

Factory setting: English or ordered local language

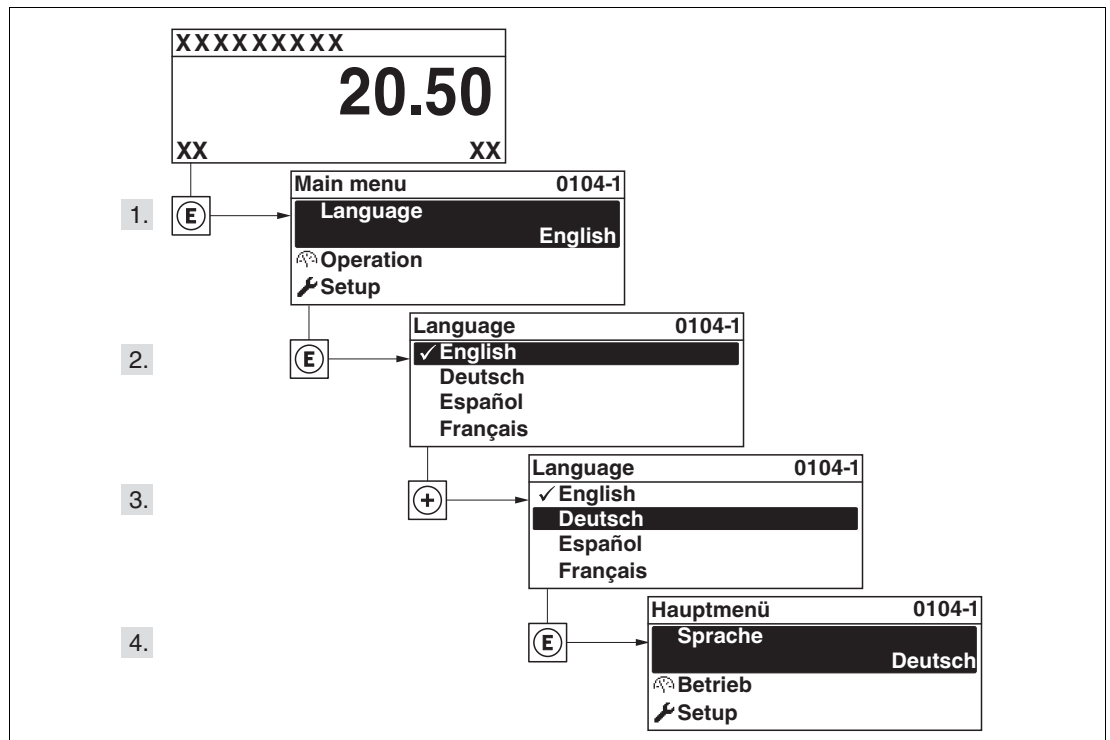

Figure 10.1 Using the example of the local display

10.3 Configuration of a level measurement

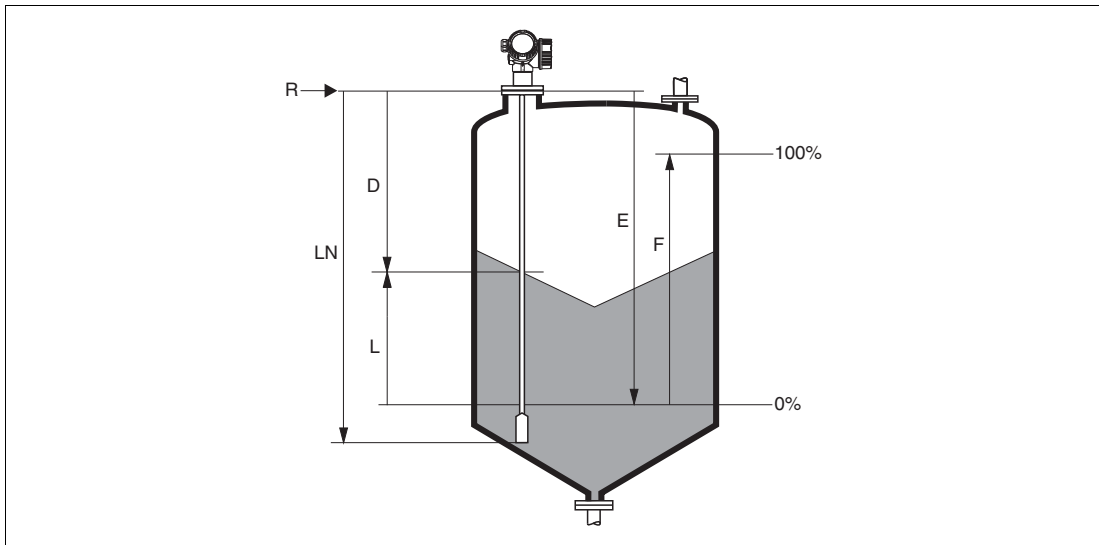

Figure 10.2 Parameters for level measurement with the guided radar

- LN** Probe length
- D** Distance
- L** Level
- R** Reference point of measurement
- E** Empty calibration (= zero)
- F** Full calibration (= span)



Note!

If for rope probes the DC value is less than 7, then measurement is not possible in the area of the straining weight. In these cases, the maximum recommended value for the empty calibration **E** is **LN** – 250 mm (**LN** – 10 in).



Configuring level measurement

1. Setup menu → Device tag
 - ↳ Enter tag for measuring point.
2. Navigate to: Setup menu → Device address
 - ↳ Enter the bus address of the device (only for software addressing).
3. Navigate to: Setup menu → Distance unit.
 - ↳ Select distance unit.
4. Navigate to: Setup menu → Bin type
 - ↳ Select bin type.
5. Navigate to: Setup menu → Empty calibration
 - ↳ Enter the distance **E** between the reference point **R** and the minimum level (0 %).
6. Navigate to: Setup menu → Full calibration.
 - ↳ Enter distance **F** between the minimum (0 %) and maximum (100 %) level.
7. Navigate to: Setup menu → Level.
 - ↳ Displays the measured level **L**.



8. Navigate to: Setup menu → Distance.
↳ Displays the distance D between the reference point R and the level L.
9. Navigate to: Setup menu → Signal quality.
↳ Displays the signal quality of the level echo.
10. For operation via local display:
Navigate to: Setup menu → Mapping → Mapping → Confirm distance
↳ Compare the displayed distance to the real distance in order to start the recording of the mapping curve if required.
11. For operation via operating tool:
Navigate to: Setup menu → Mapping → Confirm distance
↳ Compare the displayed distance to the real distance in order to start the recording of the mapping curve if required.

10.4 Recording the reference curve

After the configuration of the measurement it is recommended to record the current envelope curve as a reference curve. The reference curve can be used later on in the process for diagnostic purposes. To record the reference curve use the **Save reference curve** parameter.

Navigation: Expert → Diagnostics → Envelope diagnostics → Save reference curve

Meaning of the options

- No
No action
- Yes
The current envelope curve is saved as reference curve.



10.5 Configuration of the on-site display

10.5.1 Factory settings of the on-site display for level measurements

Parameter	Factory setting for devices with 1 current output	Factory setting for devices with 2 current outputs
Format display	1 value, max. size	1 value, max. size
Value 1 display	Level linearized	Level linearized
Value 2 display	Distance	Distance
Value 3 display	Current output 1	Current output 1
Value 4 display	None	Current output 2

Table 10.1

10.5.2 Adjustment of the on-site display

The on-site display can be adjusted in the following menu:

Navigation: Setup → Advanced setup → Display

10.6 Configuration management

After commissioning, you can save the current device configuration, copy it to another measuring point or restore the previous device configuration. You can do so using the **Configuration management** parameter and its options.

Navigation: Setup → Advanced setup → Configuration backup display → Configuration management

Meaning of the options

- **Cancel**
No action is executed and the user exits the parameter.
- **Execute backup**
A backup copy of the current device configuration in the HistoROM¹ (built-in in the device) is saved to the display module of the device. The backup copy comprises the transmitter and sensor data of the device.
- **Restore**
The last backup copy of the device configuration is copied from the display module to the HistoROM of the device. The backup copy comprises the transmitter and sensor data of the device.
- **Duplicate**
The transmitter configuration is duplicated to another device using the transmitter display module. The following parameters, which characterize the individual measuring point are **not** included in the transmitted configuration: medium type
- **Compare**
The device configuration saved in the display module is compared to the current device configuration of the HistoROM. The result of this comparison is displayed in the **Comparison result** parameter.
- **Clear backup data**
The backup copy of the device configuration is deleted from the display module of the device.



Note!

While this action is in progress, the configuration cannot be edited via the local display and a message on the processing status appears on the display.



Note!

If an existing backup is restored to a different device using the **Restore** option, it may occur that some device functionalities are no longer available. In some cases even a device reset will not restore the original status.

In order to transmit a configuration to a different device, the **Duplicate** option should always be used.

10.7 Protection of the settings against unauthorized changes

There are two ways to protect the settings against unauthorized changes:

- Via parameter settings (software locking), see chapter 8
- Via locking switch (hardware locking), see chapter 8

¹ A HistoROM is a "non-volatile" device memory in the form of an EEPROM.

11 Diagnostics and troubleshooting

11.1 General trouble shooting

11.1.1 General errors





Error	Possible cause	Remedial action
Device does not respond.	Supply voltage does not match the value indicated on the nameplate.	Connect the correct voltage.
	The cables do not contact the terminals properly.	Ensure electrical contact between the cable and the terminal.
Values on the display invisible	Contrast setting is too weak or too strong.	<ul style="list-style-type: none"> • Increase contrast by pressing  and  simultaneously. • Decrease contrast by pressing  and  simultaneously.
	The plug of the display cable is not connected correctly.	Connect the plug correctly.
	Display is defective.	Replace display.
"Communication error" is indicated on the display when starting the device or connecting the display	Electromagnetic interference	Check grounding of the device.
	Broken display cable or display plug.	Exchange display.
CDI communication does not work.	Wrong setting of the COM port on the computer.	Check the setting of the COM port on the computer and change it if necessary.
Device measures incorrectly.	Parametrization error	Check parameterization and adjust it if necessary (see next chapter).

Table 11.1

11.1.2 Parametrization errors

Error	Possible cause	Remedial action
Measured value wrong	If measured distance (Setup menu → Distance) matches the real distance: Calibration error	<ul style="list-style-type: none"> • Check and adjust the Empty calibration parameter if necessary, see page 102. • Check and adjust the Full calibration parameter if necessary, see page 102. • Check and adjust Linearization submenu if necessary, see page 116.
	If measured distance (Setup menu → Distance) does not match the real distance: An interference echo affects the measurement.	Perform mapping (Confirm distance parameter), see page 105.
No change of the measured value when emptying/filling the tank	An interference echo affects the measurement.	Perform mapping (Confirm distance parameter), see page 105.
	Build-up at the probe.	Clean the probe.
	Error in the echo tracking	Deactivate echo tracking: Expert → Sensor → Echo tracking → Evaluation mode = History off).
The Echo lost appears after switching on the supply voltage.	Noise level too high during initialization phase.	Enter Empty calibration parameter again, see page 102.
Device displays a level when the tank is empty.	Incorrect probe length	<ul style="list-style-type: none"> • Carry out probe length correction (Confirm probe length parameter), see page 130. • Carry out mapping over entire probe while the tank is empty (Confirm distance parameter), see page 105.
Wrong slope of the level in the entire measuring range	Wrong bin type selected.	Set Bin type parameter correctly, see 101.

Table 11.2 Parametrization errors for level measurements



11.2 Diagnostic information on local display

11.2.1 Diagnostic message

Faults detected by the self-monitoring system of the measuring device are displayed as a diagnostic message in alternation with the measured value display.

Measured value display in alarm condition	Diagnostic message
1	Status signal
2	Status symbol (symbol for event level)
3	Status symbol with diagnostics event
4	Event text
5	Operating elements

Table 11.3

Status signals

F	Failure (F) A device error is present. The measured value is no longer valid.
C	Function check (C) The device is in service mode (e. g. during a simulation).
S	Out of specification (S) The device is operated: <ul style="list-style-type: none"> • outside of its technical specifications (e. g. during startup or a cleaning) • outside of the configuration carried out by the user (e. g. level outside configured span)
M	Maintenance required (M) Maintenance is required. The measured value is still valid.

Table 11.4

Status symbol (symbol for event level)

	Alarm status The measurement is interrupted. The signal outputs take on the defined alarm condition. A diagnostic message is generated.
	Warning status The device continues to measure. A diagnostic message is generated.

Table 11.5

Diagnostics event and event text

The fault can be identified using the diagnostics event. The event text helps you by providing information about the fault. In addition, the corresponding symbol is displayed before the diagnostics event.

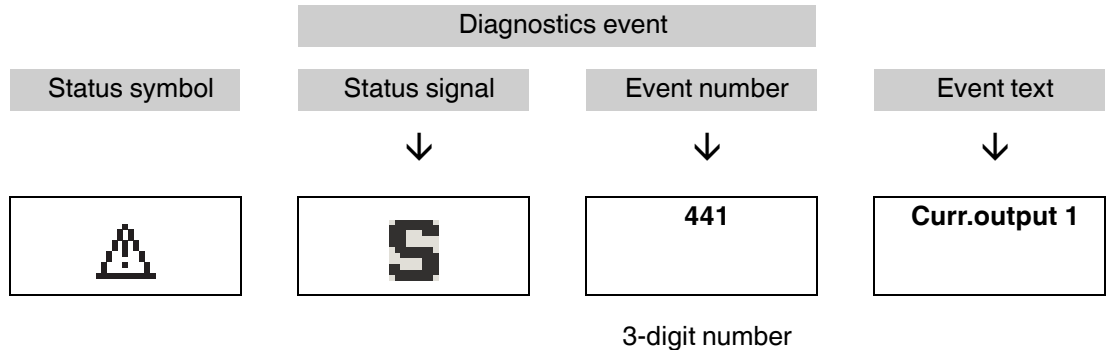

Table 11.6 Example

If two or more diagnostic messages are pending simultaneously, only the message with the highest priority is shown. Additional pending diagnostic messages can be shown in **Diagnostic list** submenu.



Note!

Past diagnostic messages that are no longer pending are shown as follows:

- On the local display: in **Event logbook** submenu
- In the software: via the Event List /HistoROM function.

Operating elements



Operating functions in menu, submenu	
	Plus key Opens the message about the remedial measures.
	Enter key Opens the operating menu.

Table 11.7

Remedial measures

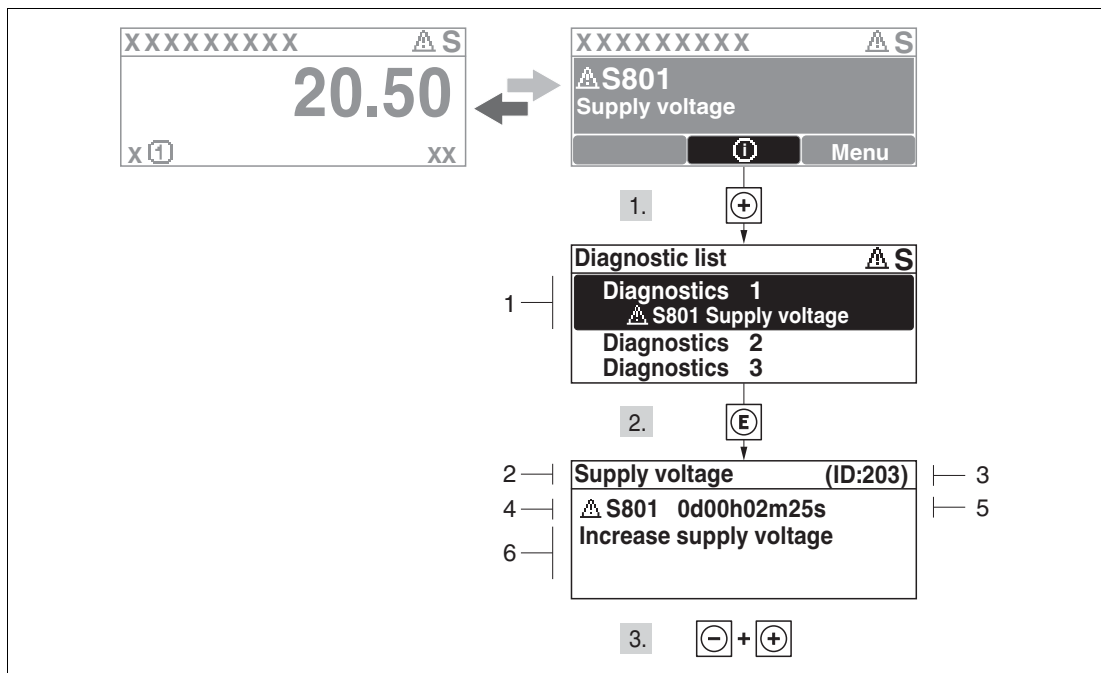

Figure 11.1 Message for remedial measures

- 1 Diagnostic information
- 2 Short text
- 3 Service ID
- 4 Diagnostic behavior with diagnostic code
- 5 Operation time of occurrence
- 6 Remedial measures



Calling up remedial measures during a diagnostic message

The user is in the diagnostic message.

1. Press (i symbol).
↳ **Diagnostic list** submenu opens.
2. Select the desired diagnostic event with or and press (i).
↳ The message for the remedial measures for the selected diagnostic event opens.
3. Press and simultaneously.
↳ The message for the remedial measures closes.



Calling up remedial measures in diagnostics menu

The user is in the **Diagnostics** menu at an entry for a diagnostics event, e. g. in **Diagnostic list** submenu or in **Previous diagnostics**.

1. Press **⏏**.
↳ The message for the remedial measures for the selected diagnostic event opens.
2. Press **⏏** and **⏏** simultaneously.
↳ The message for the remedial measures closes.

11.3

Diagnostic event in the operating tool

If a diagnostic event is present in the device, the status signal appears in the top left status in the operating tool along with the corresponding symbol for event level in accordance with NAMUR NE 107:

- Failure (F)
- Function check (C)
- Out of specification (S)
- Maintenance required (M)



Calling up remedial measures

1. Navigate to the **Diagnostics** menu.
↳ In the **Actual diagnostics** parameter, the diagnostic event is shown with event text.
2. On the right in the display range, hover the cursor over the **Actual diagnostics** parameter.
↳ A tool tip with remedial measures for the diagnostic event appears.

11.4 Diagnostic list

In the **Diagnostic list** submenu, up to 5 currently pending diagnostic messages can be displayed. If more than 5 messages are pending, the messages with the highest priority are shown on the display.

Navigation: Diagnostics → Diagnostic list



Calling up and closing the remedial measures

1. Press .
 - ↳ The message for the remedial measures for the selected diagnostic event opens.
2. Press and simultaneously.
 - ↳ The message about the remedial measures closes.

11.5 List of diagnostic events

Diagnostic number	Short text	Repairing action	Status signal (from the factory)	Diagnostic behavior (from the factory)
Diagnostic of sensor				
003	Broken probe detected	1. Check map 2. Check sensor	F	Alarm
046	Build-up detected	Clean sensor	F	Alarm
104	HF cable	1. Dry HF cable connection and check sealing 2. Change HF cable	F	Alarm
105	HF cable	1. Tighten HF cable connection 2. Check sensor 3. Change HF cable	F	Alarm
106	Sensor	1. Check sensor 2. Check HF cable 3. Contact service	F	Alarm
Diagnostic of electronic				
242	Software incompatible	1. Check software 2. Flash or change main electronics module	F	Alarm
252	Modules incompatible	1. Check electronic modules 2. Change I/O or main electronic module	F	Alarm
261	Electronic modules	1. Restart device 2. Check electronic modules 3. Change I/O module or main electronics	F	Alarm

2015-03

Diagnostic number	Short text	Repairing action	Status signal (from the factory)	Diagnostic behavior (from the factory)
262	Module connection	1. Check module connection 2. Change electronic modules	F	Alarm
270	Main electronic failure	Change main electronic module	F	Alarm
271	Main electronic failure	1. Restart device 2. Change main electronic module	F	Alarm
272	Main electronic failure	1. Restart device 2. Contact service	F	Alarm
273	Main electronic failure	1. Emergency operation via display 2. Change main electronics	F	Alarm
275	I/O module failure	Change I/O module	F	Alarm
276	I/O module failure	1. Restart device 2. Change I/O module	F	Alarm
282	Data storage	1. Restart device 2. Contact service	F	Alarm
283	Memory content	1. Transfer data or reset device 2. Contact service	F	Alarm
311	Electronic failure	1. Transfer data or reset device 2. Contact service	F	Alarm
311	Electronic failure	Maintenance required! 1. Do not perform reset 2. Contact service	M	Warning
Diagnostic of configuration				
410	Data transfer	1. Check connection 2. Retry data transfer	F	Alarm
412	Download process	Download active, please wait	C	Warning
435	Linearization	Check linearization table	F	Alarm
437	Configuration incompatible	1. Restart device 2. Contact service	F	Alarm
438	Dataset	1. Check data set file 2. Check device configuration 3. Up- and download new configuration	M	Warning
482	Block in OOS	Set block in AUTO mode	F	Alarm
484	Simulation failure mode	Deactivate simulation	C	Alarm
485	Simulation measured value	Deactivate simulation	C	Warning
494	Switch output simulation	Deactivate simulation switch output	C	Warning

Diagnostic number	Short text	Repairing action	Status signal (from the factory)	Diagnostic behavior (from the factory)
495	Diagnostics event simulation	Deactivate simulation	C	Warning
497	Block output simulation	Deactivate simulation	C	Warning
585	Simulation distance	Deactivate simulation	C	Warning
Diagnostic of process				
801	Energy too low	Increase supply voltage	S	Warning
825	Operating temperature	1. Check ambient temperature 2. Check process temperature	S	Warning
825	Operating temperature	1. Check ambient temperature 2. Check process temperature	F	Alarm
921	Change of reference	1. Check reference configuration 2. Check pressure 3. Check sensor	S	Warning
936	EMC interference	Check installation on EMC	F	Alarm
941	Echo lost	Check DC value	F	Alarm ^a
942	In safety distance	1. Check level 2. Check safety distance 3. Reset self holding	S	Alarm ^b
943	In blocking distance	Reduced accuracy Check level	S	Warning
944	Level range	Reduced accuracy Level at process connection	S	Warning
950	Advanced diagnostic 1 to 2 occurred	Maintain your diagnostic event	M	Warning ^c

Table 11.8

^a Diagnostic status is changeable.

^b Diagnostic status is changeable.

^c Diagnostic status is changeable.

11.6 Event logbook

11.6.1 Event history

A chronological overview of the event messages that have occurred is provided in the **Event list** submenu ¹.



Navigation: Diagnostics → Event logbook → Event list

A maximum of 20 event messages can be displayed in chronological order. If the advanced HistoROM function is enabled in the device (order option), up to 100 entries can be displayed.

The event history includes entries for:



- Diagnostic events
- Information events

In addition to the operation time of its occurrence, each event is also assigned a symbol that indicates whether the event has occurred or is ended:

- Diagnostic event
 - : Event has occurred
 - : Event has ended
- Information event
 - : Event has occurred



Calling up and closing the remedial measures

1. Press .
↳ The message for the remedial measures for the selected diagnostic event opens.
2. Press  and  simultaneously.
↳ The message about the remedial measures closes.

11.6.2 Filtering the event logbook

Using the **Filter options** parameter, you can define which category of event messages is displayed in the **Event list** submenu.

Navigation: Diagnostics → Event logbook → Filter options

Filter categories

- All
- Failure (F)
- Function check (C)
- Out of specification (S)
- Maintenance required (M)
- Information

¹ This submenu can only be accessed via the local display. When operating the device via Software, the event history can be displayed using **Event List /HistoROM** function.

11.6.3 List of information events

Info number	Info name
I1000	----- Device OK
I1089	Power on
I1090	Configuration reset
I1091	Configuration changed
I1092	Trend data deleted
I1110	Write protection switch changed
I1137	Electronic changed
I1151	History reset
I1154	Reset terminal voltage min/max
I1155	Reset electronic temperature
I1156	Memory error trend
I1157	Memory error event list
I1185	Display backup done
I1186	Restore via display done
I1187	Settings downloaded with display
I1188	Display data cleared
I1189	Backup compared
I1256	Display: access status changed
I1264	Safety sequence aborted
I1335	Firmware changed
I1398	CDI: access status changed
I1512	Download started
I1513	Download finished
I1514	Upload started
I1515	Upload finished

Table 11.9

11.7 Firmware history

Date	Software version	Modifications	Operating Instructions	Description of Parameters	Technical Information
07.2011	01.00.zz	Original software	BA01009O/98/EN/10.10	GP01001O/98/EN/10.10	TI01004O/98/EN/13.11
11.2014	01.01.zz	<ul style="list-style-type: none"> • Support of SD03 • additional languages • HistoROM functionality enhanced • Advanced Diagnostic function block integrated • Improvements and bugfixes 	BA01009O/98/EN/14.14	GP01001O/98/EN/13.14	TI01004O/98/EN/17.14

Table 11.10



12 Maintenance

The measuring device requires no special maintenance.

12.1 Exterior cleaning

When exterior-cleaning the device, always use cleaning agents that do not attack the surface of the housing and the seals.

13 Repairs

13.1 General information on repairs

13.1.1 Repair concept

The Pepperl+Fuchs repair concept assumes that the devices have a modular design and that repairs can be done by the Pepperl+Fuchs service or specially trained customers.

Spare parts are contained in suitable kits. They contain the related replacement instructions.

For more information on service and spare parts, contact the Service Department at Pepperl+Fuchs.

13.1.2 Repairs to Ex-approved devices

When carrying out repairs to Ex-approved devices, please note the following:

- Repairs to Ex-approved devices may only be carried out by trained personnel or by the Pepperl+Fuchs Service.
- Comply with the prevailing standards, national Ex-area regulations, safety instructions (SI) and certificates.
- Only use original spare parts from Pepperl+Fuchs.
- When ordering a spare part, please note the device designation on the nameplate. Only replace parts with identical parts.
- Carry out repairs according to the instructions. On completion of repairs, carry out the specified routine test on the device.
- Only Pepperl+Fuchs Service may convert a certified device into a different certified variant.
- Document all repair work and conversions.

13.1.3 Replacement of an electronics module

If an electronics module has been replaced, it is not necessary to perform a new basic setup as the calibration parameters are stored in the HistoROM which is located in the housing. However, after exchanging the main electronics module it may be necessary to record a new mapping (interference echo suppression).

13.1.4 Replacement of a device

After a complete device or electronic module has been replaced, the parameters can be downloaded into the instrument again in one of the following ways:

- Via the display module
Condition: The configuration of the old device has been saved in the display module.
- Via PACTware
Condition: The configuration of the old device has been saved to the computer via PACTware.

You can continue to measure without carrying out a new setup. Only a linearization and a tank map (interference echo suppression) have to be recorded again.

13.2 Spare parts

- A few interchangeable measuring device components are identified by a spare part nameplate. This contains information about the spare part.
- The connection compartment cover of the device contains a spare part nameplate that includes the following information:
 - A list of the most important spare parts for the measuring device, including their ordering information.
 - For additional information of spare parts, refer to www.pepperl-fuchs.com. There, all spare parts for the measuring device are listed, including the order code, and can be ordered. If available, the corresponding Installation Instructions can also be downloaded there.

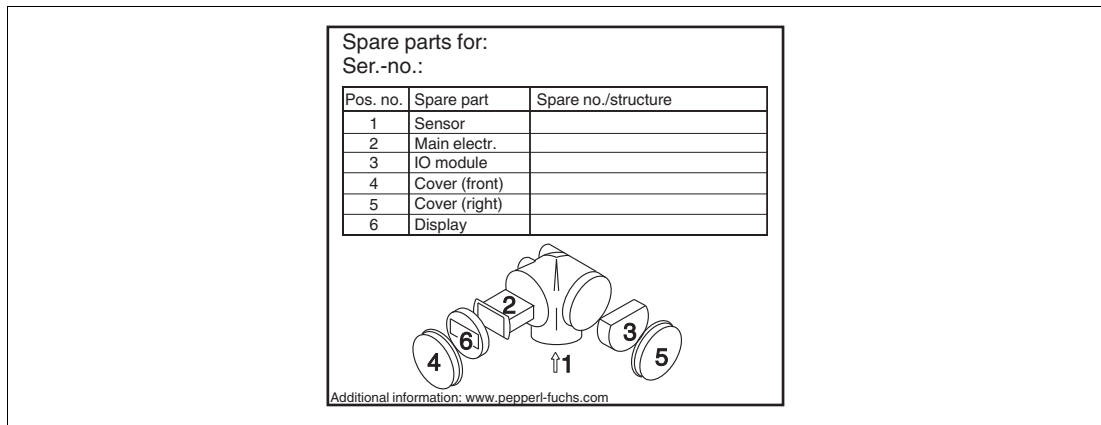

Figure 13.1 Example for spare part nameplate in connection compartment cover



Note!

Measuring device serial number:

- Is located on the device and spare part nameplate.
- Can be read out via the "Serial number" parameter in the "Device information" submenu.

13.3 Return

The measuring device must be returned if repairs or a factory calibration are required, or if the wrong measuring device has been ordered or delivered. According to legal regulations, Pepperl+Fuchs, as an ISO-certified company, is required to follow certain procedures when handling returned products that are in contact with medium.

To ensure swift, safe and professional device returns, please read the return procedures and conditions on the Pepperl+Fuchs website at (www.pepperl-fuchs.com).

13.4 Disposal

Observe the following notes during disposal:

- Observe valid federal/national regulations.
- Ensure proper separation and reuse of the device components.

14 Accessories

14.1 Device-specific accessories

14.1.1 Weather protection cover

Accessory	Description
Weather protection cover	 <p>mm (in)</p> <p>mm (in)</p> <p>a 37.8 mm (1.49 in) b 54 mm (2.13 in)</p> <p>The weather protection cover can be ordered together with the device (product structure, feature "Accessory enclosed", option B "Weather protection cover"). Alternatively, it can be separately ordered as an accessory.</p>

Table 14.1

14.1.2 Mounting bracket for the electronics housing

Accessory	Description
Mounting bracket for the electronics housing	 <p> A Wall mounting B Pipe mounting For the "Sensor remote" device version, the mounting bracket is part of the delivery. If required, it can also be ordered as an accessory. </p>

Table 14.2

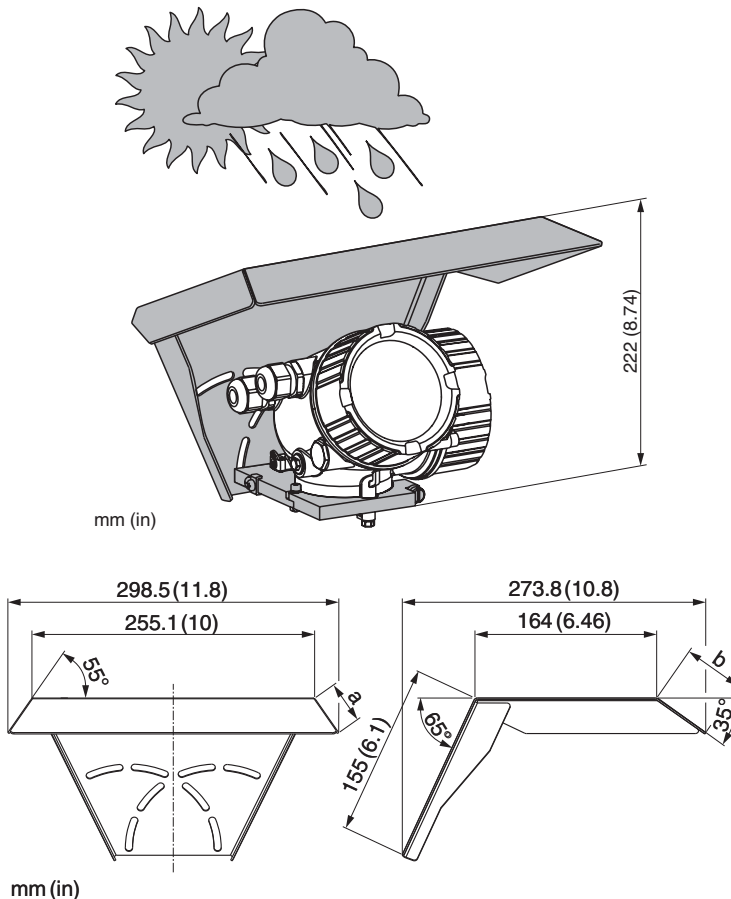
14.1.3 Mounting kit, isolated

Accessory	Description
Mounting kit, isolated	 <p> 1 Insulating sleeve 2 Eye-bolt </p> <p>For reliably insulated fixing of the probe. Maximum process temperature: 150 °C (300 °F)</p> <p>For rope probes 4 mm (1/6 in) or 6 mm (1/4 in) with PA > steel:</p> <ul style="list-style-type: none"> • Eye-bolt M8 DIN 580 • Diameter D = 20 mm (0.8 in) <p>For rope probes 6 mm (1/4 in) or 8 mm (1/3 in) with PA > steel:</p> <ul style="list-style-type: none"> • Eye-bolt M10 DIN 580 • Diameter D = 25 mm (1 in) <p>Due to the risk of electrostatic charge, the insulating sleeve is not suitable for use in hazardous areas. In these cases the fixing must be reliably grounded.</p> <p>The mounting kit can also be ordered directly with the device (see product structure, feature "Accessory enclosed", option G "Mounting kit, isolated, rope").</p>

Table 14.3

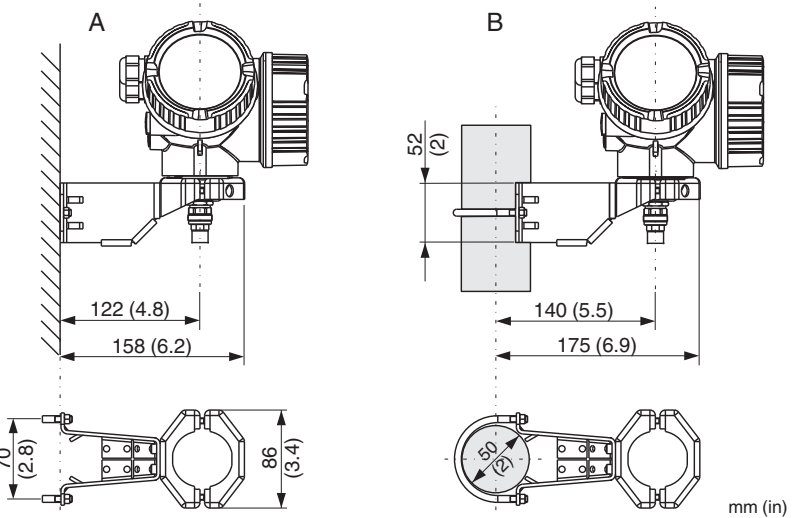
14.2 Communication-specific accessories

Accessory	Description
HART Loop Converter KFD2-HLC-Ex1.D.**	Evaluates the dynamic HART variables and converts them to analog current signals or limit values.

Table 14.4

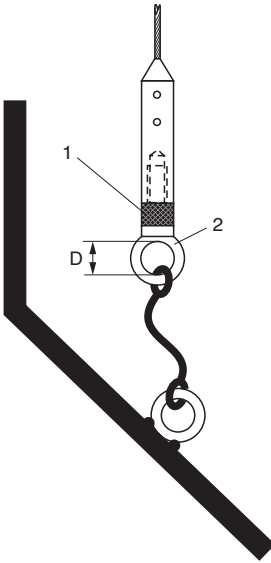
Accessory	Description
WirelessHART-Adapter WHA-ADP-F8B2-*P*-*	Connects field devices to a WirelessHART network. The WirelessHART adapter can be mounted directly at a HART device and is easily integrated into an existing HART network. It ensures safe data transmission and can be operated in parallel with other wireless networks.

Table 14.5



Note!

For details refer to data sheet on www.pepperl-fuchs.com.

14.3 Service-specific accessories

Accessory	Description
PACTware	PACTware is an operating software with graphical support (MS Windows) for intelligent transmitters with the communication protocols HART and PROFIBUS PA.

Table 14.6



Note!

For details refer to data sheet on www.pepperl-fuchs.com.

14.4 System components

Accessory	Description
KFD2-STC-Ex1	Transmitter power supply with power supply for safe isolation of 4 ... 20 mA current circuits. Provides bi-directional HART communication.

Table 14.7

Accessory	Description
KFD2-STC-1	Transmitter power supply for 2-wire sensors or transmitters exclusively for non-Ex areas. Provides bi-directional HART communication.

Table 14.8



Note!

For details refer to data sheet on www.pepperl-fuchs.com.

15 Operating menu

15.1 Overview of the operating menu (display module)

Language	page 137
Setup	page 101
Device tag	page 101
Device address	page 101
Distance unit	page 101
Bin type	page 101
Empty calibration	page 102
Full calibration	page 102
Level	page 103
Distance	page 103
Signal quality	page 104
Mapping	page 107
Confirm distance	page 107
Mapping end point	page 107
Record map	page 107
Distance	page 107
Analog inputs	
Analog input 1 to 6	page 108
Channel	page 108
PV filter time	page 108
Fail safe type	page 109
Fail safe value	page 109
Advanced setup	page 110
Locking status	page 110
Access status display	page 111
Enter access code	page 111
Level	page 112
Medium type	page 112
Medium property	page 112
Process property	page 113
Advanced process conditions	page 114
Level unit	page 114
Blocking distance	page 115
Level correction	page 115



Linearization		page 116	
	Linearization type	page 116	
	Unit after linearization	page 118	
	Free text	page 118	
	Maximum value	page 119	
	Diameter	page 119	
	Intermediate height	page 120	
	Table mode	page 121	
	Activate table	page 123	
	Edit table	page 124	
		Level	page 124
		Customer value	page 124
Safety settings		page 125	
	Output echo lost	page 125	
	Value echo lost	page 125	
	Ramp at echo lost	page 126	
	Blocking distance	page 127	
SIL/WHG confirmation		page 128	
Deactivate SIL/WHG		page 128	
	Reset write protection	page 128	
	Code incorrect	page 128	
Probe settings		page 129	
	Probe grounded	page 129	
	Probe length correction	page 131	
		Confirm probe length	page 131
		Present probe length	page 131

Switch output		page 132
	Switch output function	page 132
	Assign status	page 133
	Assign limit	page 133
	Assign diagnostic behavior	page 133
	Switch-on value	page 134
	Switch-on delay	page 135
	Switch-off value	page 135
	Switch-off delay	page 136
	Failure mode	page 136
	Switch status	page 136
	Invert output signal	page 136
Display		page 137
	Language	page 137
	Format display	page 138
	Value 1 to 4 display	page 139
	Decimal places 1 to 4	page 139
	Display interval	page 140
	Display damping	page 140
	Header	page 140
	Header text	page 141
	Separator	page 141
	Number format	page 141
	Decimal places menu	page 141
	Backlight	page 142
	Contrast display	page 142
Configuration backup display		page 143
	Operating time	page 143
	Last backup	page 143
	Configuration management	page 144
	Comparison result	page 145
Administration		page 146
	Device reset	page 147
	Define access code	page 146
	Define access code	page 148
	Confirm access code	page 148



Diagnosics	page 149
Actual diagnostics	page 149
Previous diagnostics	page 149
Operating time from restart	page 150
Operating time	page 150
Diagnostic list	page 151
Diagnostics 1 to 5	page 151
Event logbook	page 152
Filter options	page 152
Event list	page 152
Device information	page 153
Device tag	page 153
Serial number	page 153
Firmware version	page 153
Device name	page 153
Order code	page 153
Extended order code 1 to 3	page 154
Status PROFIBUS Master Config	page 154
PROFIBUS ident number	page 154
Measured values	page 155
Distance	page 155
Level linearized	page 155
Terminal voltage 1	page 155
Switch status	page 155
Analog inputs	
Analog input 1 to 6	page 156
Channel	page 156
Out value	page 156
Out status	page 157
Out status HEX	page 157
Data logging	page 158
Assign channel 1 to 4	page 158
Logging interval	page 159
Clear logging data	page 159
Display channel 1 to 4	page 160



Simulation	page 161
Assign measurement variable	page 161
Value process variable	page 161
Switch output simulation	page 161
Switch status	page 162
Simulation device alarm	page 162
Diagnostic event category	page 162
Simulation diagnostic event	page 163
Device check	page 164
Start device check	page 164
Result device check	page 164
Last check time	page 164
Level signal	page 164
Launch signal	page 165



15.2 Overview of the operating menu (operating tool)

Setup		page 101
	Device tag	page 101
	Device address	page 101
	Distance unit	page 101
	Bin type	page 101
	Empty calibration	page 102
	Full calibration	page 102
	Level	page 103
	Distance	page 103
	Signal quality	page 104
	Confirm distance	page 107
	Present mapping	page 106
	Mapping end point	page 107
	Record map	page 107
	Analog inputs	
	Analog input 1 to 6	page 108
	Channel	page 108
	PV filter time	page 108
	Fail safe type	page 109
	Fail safe value	page 109
	Advanced setup	page 110
	Locking status	page 110
	Access status tooling	page 110
	Enter access code	page 111
	Level	page 112
	Medium type	page 112
	Medium property	page 112
	Process property	page 113
	Advanced process conditions	page 114
	Level unit	page 114
	Blocking distance	page 115
	Level correction	page 115

Linearization	page 116
Linearization type	page 116
Unit after linearization	page 118
Free text	page 118
Level linearized	page 118
Maximum value	page 119
Diameter	page 119
Intermediate height	page 120
Table mode	page 121
Table number	page 122
Level	page 124
Customer value	page 124
Activate table	page 123
Safety settings	page 125
Output echo lost	page 125
Value echo lost	page 125
Ramp at echo lost	page 126
Blocking distance	page 127
SIL/WHG confirmation	page 128
Deactivate SIL/WHG	page 128
Reset write protection	page 128
Code incorrect	page 128
Probe settings	page 129
Probe grounded	page 129
Present probe length	page 131
Confirm probe length	page 131
Switch output	page 132
Switch output function	page 132
Assign status	page 133
Assign limit	page 133
Assign diagnostic behavior	page 133
Switch-on value	page 134
Switch-on delay	page 135
Switch-off value	page 135
Switch-off delay	page 136
Failure mode	page 136
Switch status	page 136
Invert output signal	page 136



Display	page 137
Language	page 137
Format display	page 138
Value 1 to 4 display	page 139
Decimal places 1 to 4	page 139
Display interval	page 140
Display damping	page 140
Header	page 140
Header text	page 141
Separator	page 141
Number format	page 141
Decimal places menu	page 141
Backlight	page 142
Contrast display	page 142
Configuration backup display	page 143
Operating time	page 143
Last backup	page 143
Configuration management	page 144
Backup state	page 144
Comparison result	page 145
Administration	page 146
Define access code	page 146
Device reset	page 147

Diagnostics	page 149
Actual diagnostics	page 149
Timestamp	page 149
Previous diagnostics	page 149
Timestamp	page 149
Operating time from restart	page 150
Operating time	page 150
Diagnostic list	page 151
Diagnostics 1 to 5	page 151
Timestamp 1 to 5	page 151
Device information	page 153
Device tag	page 153
Serial number	page 153
Firmware version	page 153
Device name	page 153
Order code	page 153
Extended order code 1 to 3	page 154
Status PROFIBUS Master Config	page 154
PROFIBUS ident number	page 154
Measured values	page 155
Distance	page 155
Level linearized	page 155
Terminal voltage 1	page 155
Switch status	page 155
Analog inputs	
Analog input 1 to 6	page 156
Channel	page 156
Out value	page 156
Out status	page 157
Out status HEX	page 157
Data logging	page 158
Assign channel 1 to 4	page 158
Logging interval	page 159
Clear logging data	page 159



Simulation	page 161
Assign measurement variable	page 161
Value process variable	page 161
Switch output simulation	page 161
Switch status	page 162
Simulation device alarm	page 162
Simulation diagnostic event	page 163
Device check	page 164
Start device check	page 164
Result device check	page 164
Last check time	page 164
Level signal	page 164
Launch signal	page 165

15.3 Setup menu



Note!

Symbols

- : Marks the navigation path to the parameter via display and operating module.
- : Marks the navigation to the parameter via operating tools (e. g. PACTware).
- : Marks parameters which can be locked by an access code.

Setup

Navigation Setup

Device tag

Blocking

Navigation Setup → Device tag

Description Enter tag for measuring point.

User entry Up to 32 alphanumeric characters (letters, numbers, special characters)

Factory settings LTC5X

Device address

Blocking

Navigation Setup → Device address

Description

- for **Address mode = Software**: Enter bus address.
- for **Address mode = Hardware**: Displays bus address.

User interface 0 to 126

Factory setting 126

Distance unit

Blocking

Navigation Setup → Distance unit

Description Select distance unit.

Selection

SI units	US units
• m	• ft
• mm	• in

Factory setting m

Bin type

Blocking

Navigation Setup → Bin type

Prerequisite **Medium type** (page 112) = **Solid**

Description Specify bin type.

Selection

- Concrete
- Plastic/wood
- Metallic
- Aluminium

Factory setting Metallic



Empty calibration

Blocking	
Navigation	Setup → Empty calibr.
Description	Specify the distance E between the process connection and the minimum level (0 %).
User entry	Depending on the probe
Factory setting	Depending on the probe
Additional information	

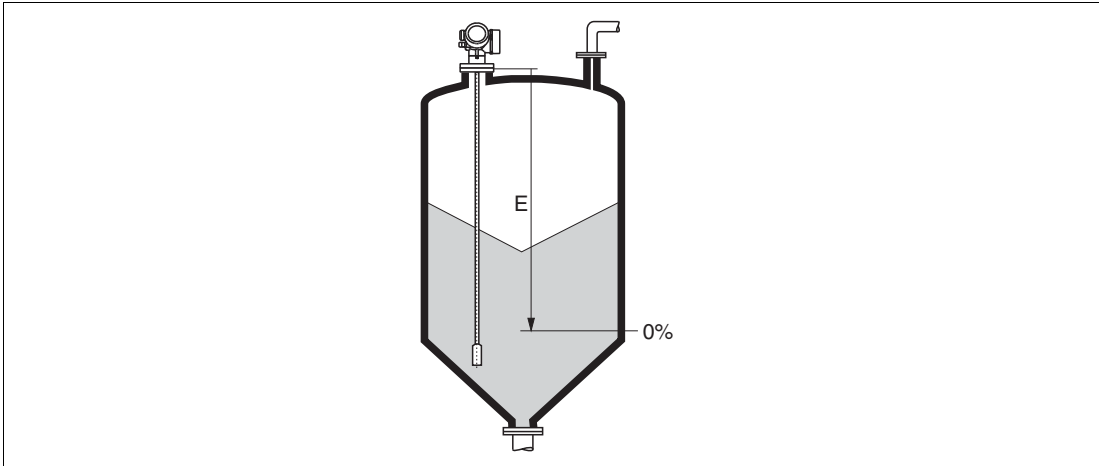

Figure 15.1 Empty calibration (E) for level measurements in bulk solids.

Full calibration

Blocking	
Navigation	Setup → Full calibr.
Description	Specify the distance F between the minimum level (0 %) and the maximum level (100 %).
User entry	Depending on the probe
Factory setting	Depending on the probe
Additional information	

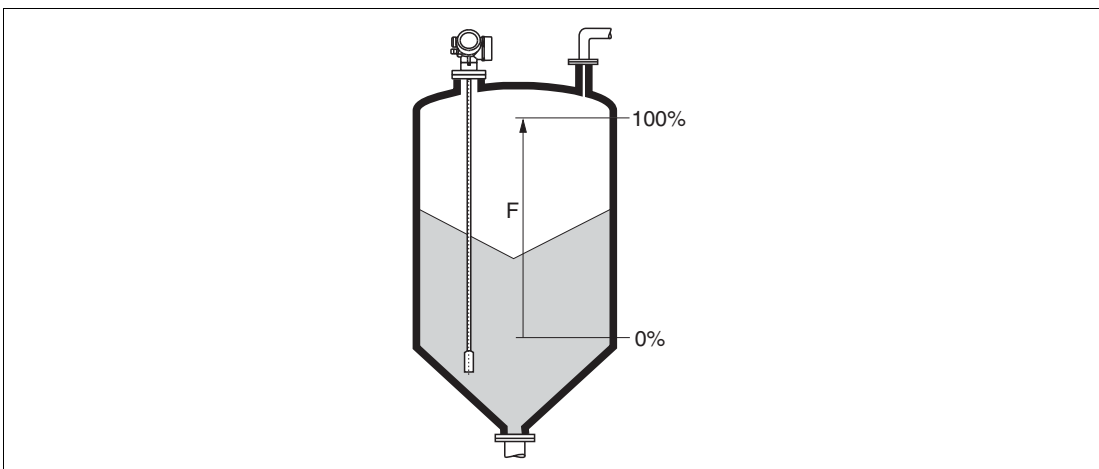

Figure 15.2 Full calibration (F) for level measurements in bulk solids

2015-03

Level

Navigation  Setup → Level

Description Displays the measured level L_L (before linearization).

Additional information **Note:** The unit is defined in the **Level unit** parameter (page 114).

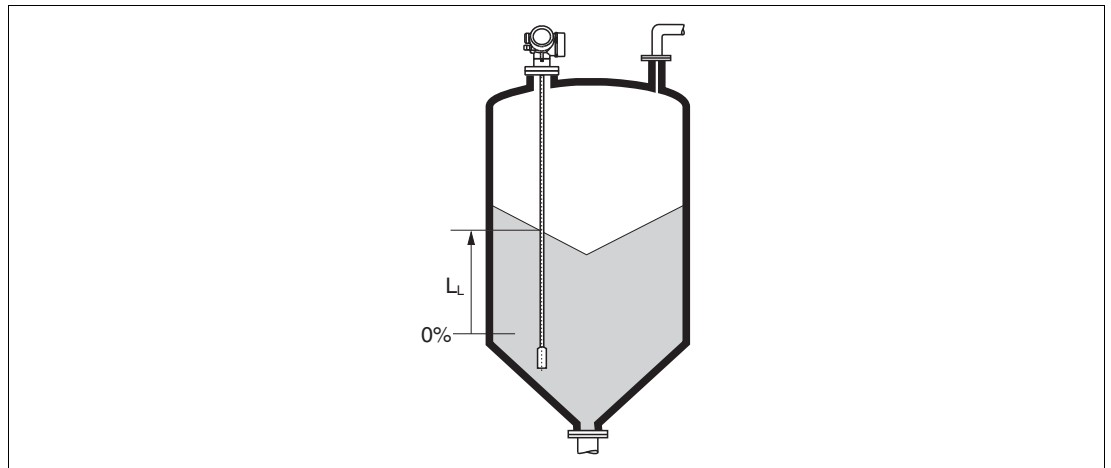

Figure 15.3 Level in case of bulk solid measurements

Distance

Navigation  Setup → Distance

Description Displays the measured distance D_L between the reference point (lower edge of the flange or threaded connection) and the level.

Additional information **Note:** The unit is defined in the **Level unit** parameter (page 101).

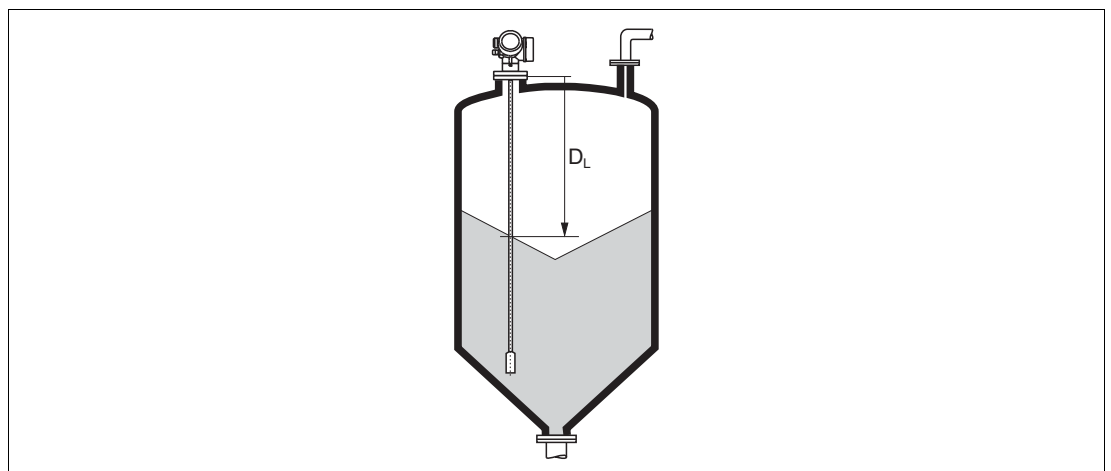



Figure 15.4 Distance for bulk solid measurements



Signal quality

Navigation

 Setup → Signal quality

Description

Displays the signal quality of the evaluated echo.

Display

- **Strong**
The evaluated echo exceeds the threshold by at least 10 mV.
- **Medium**
The evaluated echo exceeds the threshold by at least 5 mV.
- **Weak**
The evaluated echo exceeds the threshold by less than 5 mV.
- **No signal**
The device does not find a usable echo.



Additional information

The signal quality indicated in this parameter always refers to the currently evaluated echo: Either the level echo or the end-of-probe echo. To differentiate between these two, the quality of the end-of-probe echo is always displayed in brackets.

Note: In case of a lost echo (**Signal quality = No signal**) the device generates the following error message:

- F941, for **Output echo lost** (page 125) = **Alarm**.
- S941, if another option has been selected in **Output echo lost** (page 125).

Confirm distance

Blocking	
Navigation	 Setup → Confirm distance
Description	Specify, whether the measured distance matches the real distance. Depending on the selection the device automatically sets the range of mapping.
Selection	<ul style="list-style-type: none"> • Manual map • Distance OK • Distance unknown • Distance too small ^a • Distance too big ^b • Tank empty • Delete map
Factory setting	Distance unknown
Additional information	<p>Meaning of the options</p> <ul style="list-style-type: none"> • Manual map To be selected if the range of mapping is to be defined manually in the Mapping end point parameter (page 106). In this case it is not necessary to confirm the distance. • Distance OK To be selected if the measured distance matches the actual distance. The device performs a mapping. • Distance unknown To be selected if the actual distance is unknown. A mapping can not be performed in this case. • Distance too small To be selected if the measured distance is smaller than the actual distance. The device searches for the next echo and returns to the Confirm distance parameter. The distance is recalculated and displayed. The comparison must be repeated until the displayed distance matches the actual distance. After this, the recording of the map can be started by selecting Distance OK. • Distance too big To be selected if the measured distance exceeds the actual distance. The device adjusts the signal evaluation and returns to the Confirm distance parameter. The distance is recalculated and displayed. The comparison must be repeated until the displayed distance matches the actual distance. After this, the recording of the map can be started by selecting Distance OK. • Tank empty To be selected if the tank is completely empty. The device records a mapping covering the complete length of the probe. • Delete map To be selected if the present mapping curve (if one exists) is to be deleted. The device returns to the Confirm distance parameter and a new mapping can be recorded. <p>Note: When operating via the display module, the measured distance is displayed together with this parameter for reference purposes. If the teaching procedure with the Distance too small option or the Distance too big option is quit before the distance has been confirmed, a map is not recorded and the teaching procedure is reset after 60 s.</p>

^a Visibility depends on order options or device settings

^b Visibility depends on order options or device settings



Present mapping

Navigation	Setup → Present mapping
Description	Indicates up to which distance a mapping has already been recorded.

Mapping end point

Blocking	
Navigation	Setup → Map. end point
Prerequisite	Confirm distance (page 105) = Manual map or Distance too small
Description	Specify new end of the mapping.
User entry	0 to 200000.0 m
Factory setting	0.1 m
Additional information	This parameter defines up to which distance the new mapping is to be recorded. The distance is measured from the reference point, i. e. from the lower edge of the mounting flange or the threaded connection. Note: For reference purposes the Present mapping parameter (page 106) is displayed together with this parameter. It states up to which distance a mapping has already been recorded.

Record map

Blocking	
Navigation	Setup → Record map
Prerequisite	Confirm distance (page 105) = Manual map or Distance too small
Description	Start recording of the map.
Selection	<ul style="list-style-type: none"> • No • Record map • Delete map
Factory setting	No
Additional information	Meaning of the options <ul style="list-style-type: none"> • No The map is not recorded. • Record map The map is recorded. After the recording is completed, the new measured distance and the new mapping range appear on the display. When operating via the local display, these values must be confirmed by pressing <input checked="" type="checkbox"/>. • Delete map The mapping (if one exists) is deleted and the device displays the recalculated measured distance and the mapping range. When operating via the local display, these values must be confirmed by pressing <input checked="" type="checkbox"/>.



15.3.1 Mapping wizard



Note!

The **Mapping** wizard is only available when operating via the local display. When operating via an operating tool, all parameters concerning the mapping are located directly in the **Setup** menu (page 101).



Note!

In the **Mapping** wizard two parameters are displayed simultaneously on the display module at any one time. The upper parameter can be edited, whereas the lower parameter is displayed for reference purposes only.

Mapping wizard

Navigation Setup → Mapping

Confirm distance

Blocking

Navigation Setup → Mapping → Confirm distance

Description **Confirm distance** (page 105)

Mapping end point

Blocking

Navigation Setup → Mapping → Map. end point

Description **Mapping end point** (page 106)

Record map

Blocking

Navigation Setup → Mapping → Record map

Description **Record map** (page 106)

Distance

Navigation Setup → Mapping → Distance

Description **Distance** (page 103)



15.3.2 Analog input 1 to 6 submenu

Analog input 1 to 6

Note: There is an **Analog input** submenu for each AI block of the device. The AI block is used to configure the measured value transmission to the bus. Only the most basic properties of the AI blocks can be configured in this submenu. For a detailed configuration of the AI blocks refer to Expert → Analog inputs → Analog input 1 to 6.

Navigation Expert → Analog inputs → Analog input 1 to 6

Channel

Blocking

Navigation Expert → Analog inputs → Analog input 1 to 6 → Channel

Description Standard parameter **CHANNEL** of the Analog Input Block according to the PROFIBUS profile.

Selection

- Level linearized
- Distance
- Terminal voltage
- Electronic temperature
- Measured capacitance ^a
- Absolute echo amplitude
- Relative echo amplitude
- Absolute EOP amplitude
- Noise of signal
- EOP shift
- Calculated DC value ^b
- Sensor debug
- Analog output adv. diagnostics 1
- Analog output adv. diagnostics 2

Factory setting Level linearized

Additional information Allocates a measured value to the AI block.

^a Visibility depends on order options or device settings

^b Visibility depends on order options or device settings

PV filter time

Blocking

Navigation Expert → Analog inputs → Analog input 1 to 6 → PV filter time



Description Standard parameter **PV_FTIME** of the Analog Input Block according to the PROFIBUS profile

User entry Positive floating-point number



Factory setting 0

Additional information This parameter defines the damping constant τ (in seconds) for the output of the Analog Input Block.

Fail safe type

Blocking	
Navigation	 Expert → Analog inputs → Analog input 1 to 6 → Fail safe type
Description	Standard parameter FSAFE_TYPE of the Analog Input Block according to the PROFIBUS profile.
Selection	<ul style="list-style-type: none">• Fail safe value• Fallback value• Off
Factory setting	Off
Additional information	Meaning of the options This parameter specifies the output value of the Analog Input Block in the event of an error. <ul style="list-style-type: none">• Fail safe value The output value in the event of an error is defined in the Fail safe value parameter (page 109).• Fallback value The last output value that was valid before the error occurred is retained.• Off The output value follows the current measured value. The status is set to BAD.

Fail safe value

Blocking	
Navigation	 Expert → Analog inputs → Analog input 1 to 6 → Fail safe value
Prerequisite	Fail safe type (page 109) = Fail safe value
Description	Standard parameter FSAFE_VALUE of the Analog Input Block according to the PROFIBUS profile.
User entry	Signed floating-point number
Factory setting	0
Additional information	This parameter defines the output value of the Analog Input Block in case of an error.



15.3.3 Advanced setup submenu

Advanced setup

Navigation Setup → Advanced setup

Locking status

Navigation Setup → Advanced setup → Locking status

Description Indicates the write protection with the highest priority that is currently active.

- User interface**
- Hardware locked
 - SIL locked
 - WHG locked
 - Temporarily locked

Additional information Meaning and priorities of the types of write protection

- **Hardware locked (priority 1)**
The DIP switch for hardware locking is activated on the main electronics module. This locks write access to the parameters.
- **SIL locked (priority 2)**
The SIL mode is activated. Writing access to the relevant parameters is denied.
- **WHG locked (priority 3)**
The WHG mode is activated. Writing access to the relevant parameters is denied.
- **Temporarily locked (priority 4)**
Write access to the parameters is temporarily locked on account of internal processes in progress in the device (e. g. data upload/download, reset etc.).
The parameters can be modified as soon as the processes are complete.

Note: On the display module, the symbol appears in front of parameters that cannot be modified since they are write-protected.

Access status tooling

Navigation Setup → Advanced setup → Access stat.tool

Description Indicates access authorization to parameters via operating tool.

- User interface**
- Operator
 - Maintenance
 - Service

Additional information **Note:** The access authorization can be changed via the **Enter access code** parameter (page 111).

Note: If additional write protection is active, this restricts the current access authorization even further. The write protection status can be viewed via the **Locking status** parameter (page 110).

Access status display

Navigation	☰ Setup → Advanced setup → Access stat.disp
Prerequisite	The device has a local display.
Description	Indicates access authorization to parameters via local display.
User interface	<ul style="list-style-type: none">• Operator• Maintenance• Service
Additional information	<p>Note: If a ☰ symbol appears in front of a parameter, the parameter cannot be changed via the local display with the current access authorization.</p> <p>Note: The access authorization can be changed via the Enter access code parameter (page 111).</p> <p>Note: If additional write protection is active, this restricts the current access authorization even further. The write protection status can be viewed via the Locking status parameter (page 110).</p>

Enter access code

Navigation	☰☰ Setup → Advanced setup → Ent. access code
Description	Enter access code to disable write protection of parameters.
User entry	0 to 9999
Additional information	<ul style="list-style-type: none">• For local operation, the customer-specific access code, which has been defined in the Define access code parameter (page 146), has to be entered.• If an incorrect access code is entered, the user retains his current access authorization.• The write protection affects all parameters marked with the ☰ symbol in this document. On the local display, the ☰ symbol in front of a parameter indicates that the parameter is write-protected.• If no key is pressed for 10 min, or the user switches from the navigation and editing mode back to the measured value display mode, the device automatically locks the write protected parameters after another 60 s. <p>Note: Please contact your Pepperl+Fuchs Sales Center if you lose your access code.</p>



15.3.4 Level submenu

Level

Navigation  Setup → Advanced setup → Level

Medium type

Navigation  Setup → Advanced setup → Level → Medium type

Description Specify type of medium.

User interface

- Liquid
- Solid

Factory setting

- LTC50, LTC51: **Liquid**
- LTC57: **Solid**

Additional information The **Solid** option is only available for **Operating mode = Level**
Note: This parameter determines the value of several other parameters and strongly influences the complete signal evaluation. Therefore, it is strongly recommended **not to change** the factory setting.

Medium property

Blocking 

Navigation  Setup → Advanced setup → Level → Medium property

Prerequisite **EOP level evaluation ≠ Fix DC**

Description Specify relative dielectric constant ϵ_r of the medium.

Selection

- Unknown
- DC 1.4 to 1.6
- DC 1.6 to 1.9
- DC 1.9 to 2.5
- DC 2.5 to 4
- DC 4 to 7
- DC 7 to 15
- DC > 15

Factory setting Dependent on **Medium type** (page 112) and **Medium group**.



Additional information Dependency on **Medium type** and **Medium group**

Medium type	Medium group	Medium property
Liquid	Water based (DC \geq 4)	DC 4 to 7
	Others	Unknown
Solid	–	Unknown

Note: Dielectric constants of important media commonly used in the industry are summarized in the technical information (TI).

Note: For **EOP level evaluation = Fix DC**, the exact dielectric constant has to be entered into the **DC value** parameter. Therefore, the **Medium property** parameter is not available in this case.

Process property

Blocking	
Navigation	 Setup → Advanced setup → Level → Process property
Description	Specify typical rate of level change.
Selection	<p>For Medium type = Liquid</p> <ul style="list-style-type: none"> • Very fast > 10 m (400 in)/min • Fast > 1 m (40 in)/min • Standard. < 1 m (40 in)/min • Medium < 10 cm (4 in)/min • Slow < 1 cm (0.4 in)/min • No filter/test <p>For Medium type = Solid</p> <ul style="list-style-type: none"> • Very fast > 100 m (333 ft)/h • Fast > 10 m (33 ft)/h • Standard < 10 m (33 ft)/h • Medium < 1 m (3 ft)/h • Slow < 0.1 m (0.3 ft)/h • No filter/test
Factory setting	Standard < 1 m (40 in)/min
Additional information	The device adjusts the signal evaluation filters and the damping of the output signal to the typical rate of level change defined in this parameter:

For Medium type = Liquid

Process property	Step response time/s
Very fast > 10 m (400 in)/min	5
Fast > 1 m (40 in)/min	5
Standard < 1 m (40 in)/min	14
Medium < 10 cm (4 in)/min	39
Slow < 1 cm (0.4 in)/min	76
No filter/test	< 1

For Medium type = Solid

Process property	Step response time/s
Very fast > 100 m (333 ft)/h	37
Fast > 10 m (33 ft)/h	37
Standard < 10 m (33 ft)/h	74
Medium < 1 m (3ft)/h	146
Slow < 0.1 m (0.3ft)/h	290
No filter/test	< 1



Advanced process conditions

Blocking	
Navigation	Setup → Advanced setup → Level → Adv. conditions
Description	Specify additional process conditions (if required).
Selection	<ul style="list-style-type: none"> • None • Oil/water condensate ^a • Probe near tank bottom ^b • Build up • Foam (> 5 cm/0.16 ft) ^c
Factory setting	None
Additional information	<p>Meaning of the options</p> <ul style="list-style-type: none"> • Oil/water condensate Makes sure that in the case of two-phase media always the total level is detected (example: oil/condensate application). • Probe near tank bottom Improves the empty detection, especially if the probe is mounted close to the tank bottom. • Build up Increases EOP range upper area in order to ensure a safe empty-detection even if the end-of-probe signal has shifted due to build-up. Enables a safe empty-detection even if the end-of-probe signal has shifted due to build-up. • Foam (> 5 cm/0.16 ft) Optimizes the signal evaluation in applications with foam formation.

^a only for **Medium type = Liquid**
^b only for **Medium type = Liquid**
^c only for **Medium type = Liquid**

Level unit

Blocking					
Navigation	Setup → Advanced setup → Level → Level unit				
Description	Select level unit.				
Selection	<table border="0" style="width: 100%;"> <tr> <td style="width: 50%;">SI units</td> <td style="width: 50%;">US units</td> </tr> <tr> <td> <ul style="list-style-type: none"> • % • m • mm </td> <td> <ul style="list-style-type: none"> • ft • in </td> </tr> </table>	SI units	US units	<ul style="list-style-type: none"> • % • m • mm 	<ul style="list-style-type: none"> • ft • in
SI units	US units				
<ul style="list-style-type: none"> • % • m • mm 	<ul style="list-style-type: none"> • ft • in 				
Factory setting	%				
Additional information	<p>The level unit may differ from the distance unit defined in the Distance unit parameter (page 101):</p> <ul style="list-style-type: none"> • The unit defined in the Distance unit parameter is used for the basic calibration (Empty calibration (page 102) and Full calibration (page 102)). • The unit defined in the Level unit parameter is used to display the (unlinearized) level. 				

Blocking distance

Blocking	🔒
Navigation	📄 Setup → Advanced setup → Level → Blocking dist.
Description	Specify upper blocking distance UB.
User entry	0 to 200 m
Factory setting	<ul style="list-style-type: none"> • For coax probes: 0 mm (0 in) • For rod and rope probes up to 8 m (26 ft): 200 mm (8 in) • For rod and rope probes above 8 m (26 ft): 0.025 x length of probe
Additional information	No echoes are evaluated within the blocking distance UB. Therefore, UB can be used to suppress interference echos within the upper end of the probe.

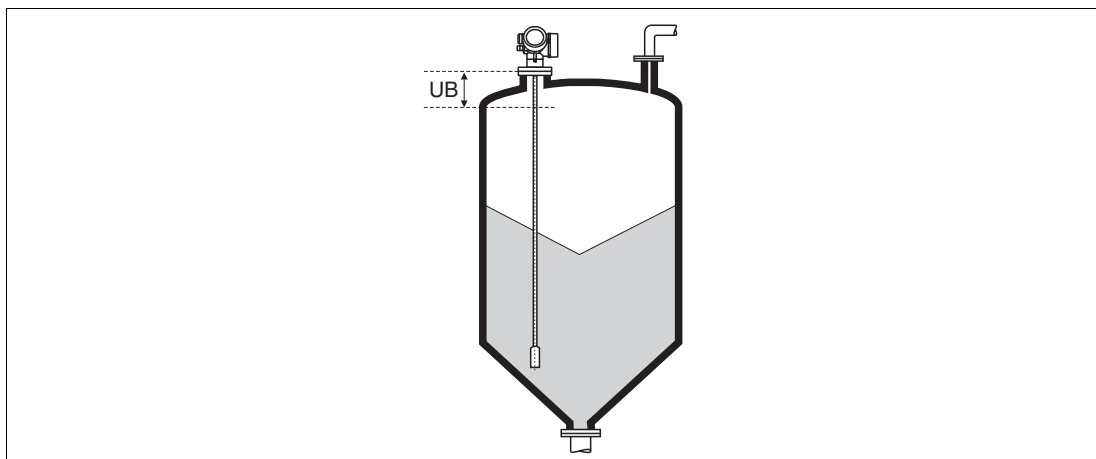

Figure 15.5 Blocking distance (UB) for bulk solid measurements

Level correction

Blocking	🔒
Navigation	📄 Setup → Advanced setup → Level → Level correction
Description	Specify level correction (if required).
User entry	-200000.0 to 200000.0 %
Factory setting	0.0 %
Additional information	The value specified in this parameter is added to the measured level (before linearization).



15.3.5 Linearization submenu

Linearization

Navigation  Setup → Advanced setup → Linearization

Linearization type

Blocking 

Navigation  Setup → Advanced setup → Linearization → Lineariz. type

Description Select linearization type.

- Selection**
- None
 - Linear
 - Table
 - Pyramid bottom
 - Conical bottom
 - Angled bottom
 - Horizontal cylinder
 - Sphere

Factory setting None

Additional information Meaning of the options

- **None**
The level is transmitted in the level unit without linearization.
- **Linear**
The output value (volume/weight) is directly proportional to the level L. This is valid, for example, for vertical cylinders. The following additional parameters have to be specified:
 - **Unit after linearization** (page 118)
 - **Maximum value** (page 119): Maximum volume or weight
- **Table**
The relationship between the measured level L and the output value (volume/weight) is given by a linearization table consisting of up to 32 pairs of values "level - volume" or "level - weight", respectively. The following additional parameters have to be specified:
 - **Unit after linearization** (page 118)
 - **Table mode** (page 121)
 - For each table point: **Level** (page 122)
 - For each table point: **Customer value** (page 122)
 - **Activate table** (page 123)
- **Pyramid bottom**
The output value corresponds to the volume or weight in a silo with pyramid bottom. The following additional parameters have to be specified:
 - **Unit after linearization** (page 118)
 - **Maximum value** (page 119): Maximum volume or weight
 - **Intermediate height** (page 120): The height of the pyramid
- **Conical bottom**
The output value corresponds to the volume or weight in a tank with conical bottom. The following additional parameters have to be specified:
 - **Unit after linearization** (page 118)
 - **Maximum value** (page 119): Maximum volume or weight
 - **Intermediate height** (page 120): The height of the conical part of the tank

Additional information • Angled bottom

The output value corresponds to the volume or weight in a silo with an angled bottom. The following additional parameters have to be specified:

- **Unit after linearization** (page 118)
- **Maximum value** (page 119): Maximum volume or weight
- **Intermediate height** (page 120): Height of the angled bottom

• Horizontal cylinder

The output value corresponds to the volume or weight in a horizontal cylinder. The following additional parameters have to be specified:

- **Unit after linearization** (page 118)
- **Maximum value** (page 119): Maximum volume or weight
- **Diameter** (page 119)

• Sphere

The output value corresponds to the volume or weight in a spherical tank. The following additional parameters have to be specified:

- **Unit after linearization** (page 118)
- **Maximum value** (page 119): Maximum volume or weight
- **Diameter** (page 119)

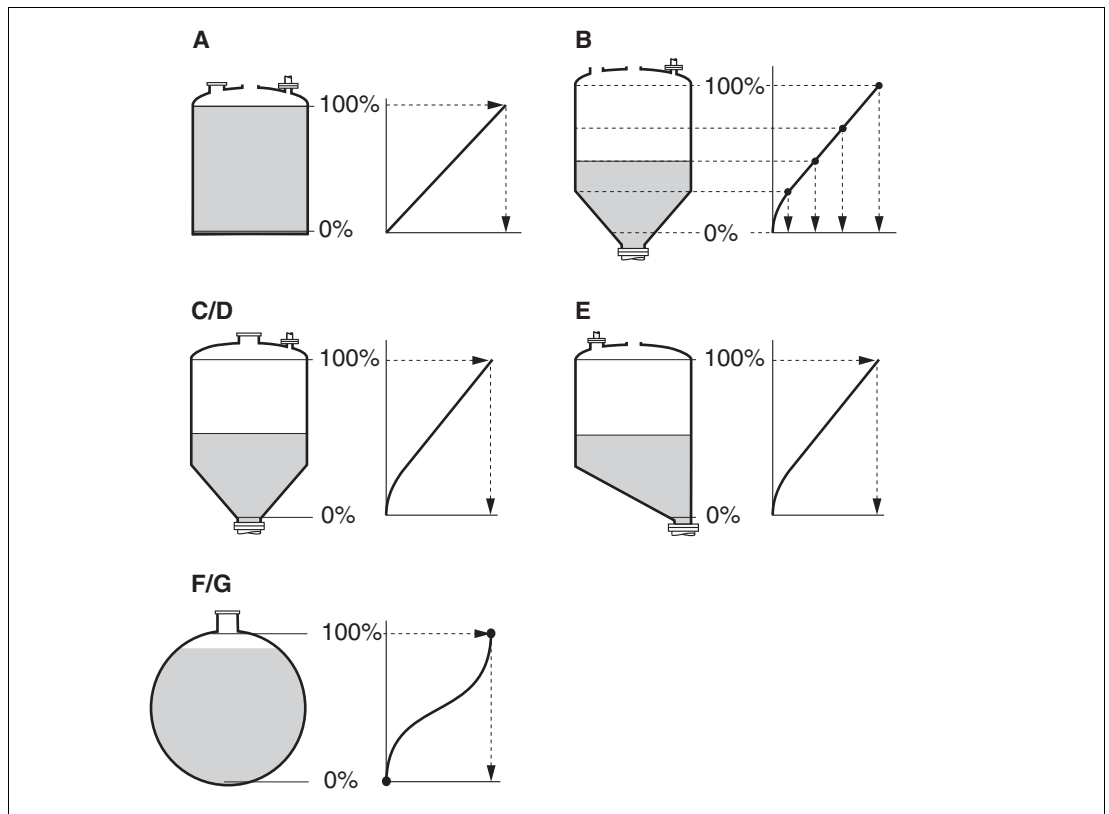

Figure 15.6 Linearization types

- A** None
- B** Table
- C** Pyramid bottom
- D** Conical bottom
- E** Angled bottom
- F** Sphere
- G** Horizontal cylinder



Unit after linearization

Blocking																																					
Navigation	Setup → Advanced setup → Linearization → Unit lineariz.																																				
Prerequisite	Linearization type (page 116) ≠ None																																				
Description	Select unit of the linearized value.																																				
Selection	<table border="0"> <thead> <tr> <th>SI units</th> <th>US units</th> <th>Imperial units</th> </tr> </thead> <tbody> <tr> <td>• STon</td> <td>• lb</td> <td>impGal</td> </tr> <tr> <td>• t</td> <td>• UsGal</td> <td></td> </tr> <tr> <td>• kg</td> <td>• ft³</td> <td></td> </tr> <tr> <td>• cm³</td> <td></td> <td></td> </tr> <tr> <td>• dm³</td> <td></td> <td></td> </tr> <tr> <td>• m³</td> <td></td> <td></td> </tr> <tr> <td>• hl</td> <td></td> <td></td> </tr> <tr> <td>• l</td> <td></td> <td></td> </tr> <tr> <td>• %</td> <td></td> <td></td> </tr> <tr> <td colspan="3">Custom-specific units</td> </tr> <tr> <td colspan="3">Free text</td> </tr> </tbody> </table>	SI units	US units	Imperial units	• STon	• lb	impGal	• t	• UsGal		• kg	• ft ³		• cm ³			• dm ³			• m ³			• hl			• l			• %			Custom-specific units			Free text		
SI units	US units	Imperial units																																			
• STon	• lb	impGal																																			
• t	• UsGal																																				
• kg	• ft ³																																				
• cm ³																																					
• dm ³																																					
• m ³																																					
• hl																																					
• l																																					
• %																																					
Custom-specific units																																					
Free text																																					
Factory setting	%																																				
Additional information	<p>The selected unit is only used to be indicated on the display. The measured value is not transformed according to the selected unit.</p> <p>Note: It is also possible to configure a distance-to-distance linearization, i. e. a transformation from the level unit to a different distance unit. To do so, select the Linear linearization mode. In order to define the new level unit, select the Free text option in the Unit after linearization parameter and enter the required unit into the Free text parameter (page 118).</p>																																				



Free text

Blocking	
Navigation	Setup → Advanced setup → Linearization → Free text
Prerequisite	Unit after linearization (page 118) = Free text
Description	Enter unit symbol.
User entry	Up to 32 alphanumerical characters (letters, numbers, special characters)
Factory setting	Free text



Level linearized

Navigation	Setup → Advanced setup → Linearization → Level linearized
Description	Displays linearized level.
Additional information	Note: The unit is defined by the Unit after linearization parameter (page 118).

Maximum value

Blocking	
Navigation	 Setup → Advanced setup → Linearization → Maximum value
Prerequisite	Linearization type (page 116) has one of the following values: <ul style="list-style-type: none">• Linear• Pyramid bottom• Conical bottom• Angled bottom• Horizontal cylinder• Sphere
Description	Specify the maximum content of the vessel (100 %) measured in the units after linearization.
User entry	-50000.0 to 50000.0 %
Factory setting	100.0 %

Diameter

Blocking	
Navigation	 Setup → Advanced setup → Linearization → Diameter
Prerequisite	Linearization type (page 116) has one of the following values: <ul style="list-style-type: none">• Horizontal cylinder• Sphere
Description	Specify tank diameter.
User entry	0 to 9999.999 m
Factory setting	2 m
Additional information	The unit is defined in the Distance unit parameter (page 101).



Intermediate height

Blocking	
Navigation	Setup → Advanced setup → Linearization → Intermed. height
Prerequisite	Linearization type (page 116) has one of the following values: <ul style="list-style-type: none">• Pyramid bottom• Conical bottom• Angled bottom
Description	Specify intermediate height H.
User entry	0 to 200 m
Factory setting	0 m
Additional information	The unit is defined in the Distance unit parameter (page 101).

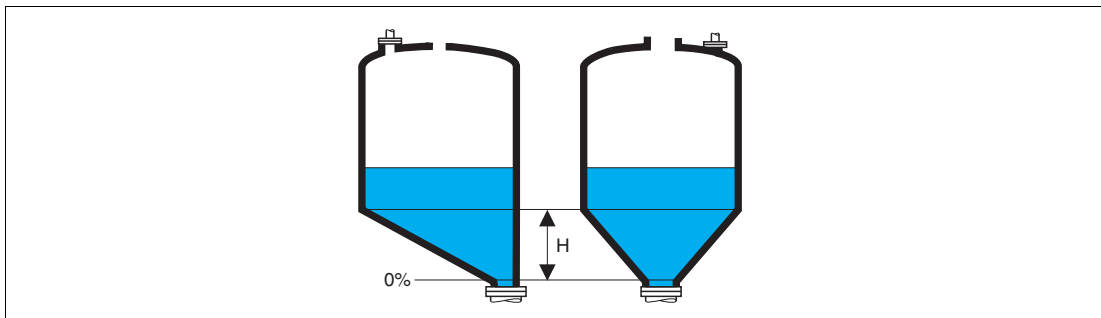



Figure 15.7

H Intermediate height

Table mode

Blocking	
Navigation	 Setup → Advanced setup → Linearization → Table mode
Prerequisite	Linearization type (page 116) = Table
Description	Select editing mode of the linearization table.
Selection	<ul style="list-style-type: none"> • Manual • Semi-automatic ^a • Clear table • Sort table
Factory setting	Manual
Additional information	<p>Meaning of the options</p> <ul style="list-style-type: none"> • Manual The level and the associated linearized value are entered manually for each linearization point. • Semi-automatic The level is measured by the device for each linearization point. The associated linearized value is entered manually. • Clear table Deletes the existing linearization table. • Sort table Rearranges the linearization points into an ascending order. <p>Conditions the linearization table must meet:</p> <ul style="list-style-type: none"> • The table may consist of up to 32 pairs of values "Level - Linearized Value". • The table must be monotonic (monotonically increasing or decreasing). • The first linearization point must refer to the minimum level. • The last linearization point must refer to the maximum level. <p>Note: Before entering a linearization table, the values for Empty calibration (page 102) and Full calibration (page 102) must be set correctly. If values of the table need to be changed after the full or empty calibration have been changed, a correct evaluation is only ensured if the existing table is deleted and the complete table is entered again. To do so delete the existing table (Table mode = Clear table). Then enter a new table.</p> <p>How to enter the table</p> <ul style="list-style-type: none"> • Via PACTware The table points can be entered via the Table number (page 122), Level (page 122) and Customer value (page 122) parameters. As an alternative, the graphic table editor may be used: Device Operation → Device Functions → Additional Functions → Linearization (Online/Offline) • Via local display Select the Edit table (page 124) submenu to call up the graphic table editor. The table is displayed and can be edited line by line. <p>Note: The factory setting for the level unit is "%". If you want to enter the linearization table in physical units, you must select the appropriate unit in the Level unit parameter (page 114) beforehand.</p>

^a Visibility depends on order options or device settings



Table number

Blocking	
Navigation	Setup → Advanced setup → Linearization → Table number
Prerequisite	Linearization type (page 116) = Table
Description	Select table point you are going to enter or change.
User entry	1 to 32
Factory setting	1

Level (Manual)

Blocking	
Navigation	Setup → Advanced setup → Linearization → Level
Prerequisite	<ul style="list-style-type: none">• Linearization type (page 116) = Table• Table mode (page 121) = Manual
Description	Enter level value of the table point (value before linearization).
User entry	Signed floating-point number
Factory setting	0 %

Level (Semi-automatic)

Navigation	Setup → Advanced setup → Linearization → Level
Prerequisite	<ul style="list-style-type: none">• Linearization type (page 116) = Table• Table mode (page 121) = Semi-automatic
Description	Displays measured level (value before linearization). This value is transmitted to the table.

Customer value

Blocking	
Navigation	Setup → Advanced setup → Linearization → Customer value
Prerequisite	Linearization type (page 116) = Table
Description	Enter linearized value for the table point.
User entry	Signed floating-point number
Factory setting	0 %



Activate table

Blocking	
Navigation	Setup → Advanced setup → Linearization → Activate table
Prerequisite	Linearization type (page 116) = Table
Description	Activate (enable) or deactivate (disable) the linearization table.
Selection	<ul style="list-style-type: none">• Disable• Enable
Factory setting	Disable
Additional information	Meaning of the options <ul style="list-style-type: none">• Disable The measured level is not linearized. If Linearization type (page 116) = Table at the same time, the device issues error message F435.• Enable The measured level is linearized according to the table. <p>Note: When editing the table, the Activate table parameter is automatically reset to Disable and must be reset to Enable after the table has been entered.</p>



15.3.6 Edit table submenu

Edit table

Note: The **Edit table** submenu is only available when operating via the local display. When operating via an operating tool, all parameters concerning the table editor are located directly in the **Linearization** submenu (page 116).

Navigation  Setup → Advanced setup → Linearization → Edit table

Level

Blocking 

Navigation  Setup → Advanced setup → Linearization → Edit table → Level

Description **Level** (page 122)

Customer value

Blocking 

Navigation  Setup → Advanced setup → Linearization → Edit table → Customer value

Description **Customer value** (page 122)

15.3.7 Safety settings submenu

Safety settings

Navigation  Setup → Advanced setup → Safety sett.

Output echo lost

Blocking 

Navigation  Setup → Advanced setup → Safety sett. → Output echo lost

Description Define the behavior of the output signal in case of a lost echo.

Selection

- Last valid value
- Ramp at echo lost
- Value echo lost
- Alarm

Factory setting Last valid value

Additional information Meaning of the options

- **Last valid value**
The last valid value is kept in the case of a lost echo.
- **Ramp at echo lost**
In the case of a lost echo the output value is continuously shifted towards 0 % or 100 %. The slope of the ramp is defined in the **Ramp at echo lost** parameter (page 126).
- **Value echo lost**
In the case of a lost echo the output assumes the value defined in the **Value echo lost** parameter (page 125).
- **Alarm**
In the case of a lost echo the device generates an alarm; see the **Failure mode** parameter (page 136).

Value echo lost

Blocking 

Navigation  Setup → Advanced setup → Safety sett. → Value echo lost

Prerequisite **Output echo lost** (page 125) = **Value echo lost**

Description Define output value in case of a lost echo.

User entry 0 to 200000.0 %

Factory setting 0.0 %

Additional information Use the unit which has been defined for the measured value output:

- without linearization: **Level unit** (page 114)
- with linearization: **Unit after linearization** (page 118)



Ramp at echo lost

Blocking

Navigation Setup → Advanced setup → Safety sett. → Ramp echo lost

Prerequisite **Output echo lost** (page 125) = **Ramp at echo lost**

Description Define the slope of the ramp in the case of a lost echo.

User entry Signed floating-point number

Factory setting 0.0 %/min

- Additional information**
- The unit for the slope of the ramp is "percentage of the measuring range per minute" (%/min).
 - For a negative slope of the ramp: The measured value is continuously decreased until it reaches 0 %.
 - For a positive slope of ramp: The measured value is continuously increased until it reaches 100 %.

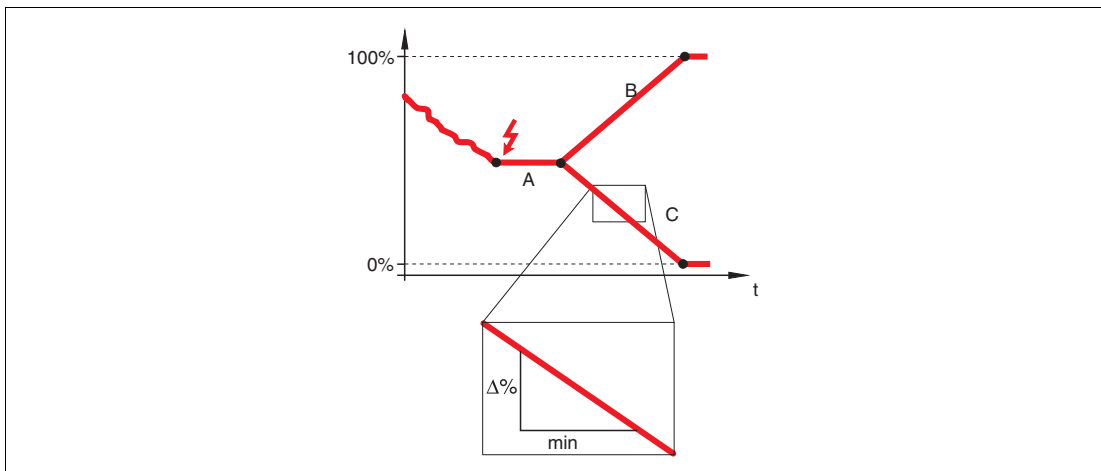

Figure 15.8

- A** Delay time echo lost
B Ramp at echo lost (positive value)
C Ramp at echo lost (negative value)

Blocking distance

Blocking	🔒
Navigation	📄 Setup → Advanced setup → Safety sett. → Blocking dist.
Description	Specify upper blocking distance UB.
User entry	0 to 200 m
Factory setting	<ul style="list-style-type: none">• For coax probes: 0 mm (0 in)• For rod and rope probes up to 8 m (26 ft): 200 mm (8 in)• For rod and rope probes above 8 m (26 ft): 0.025 x length of probe
Additional information	No echoes are evaluated within the blocking distance UB. Therefore, UB can be used to: Suppress interference echoes within the upper end of the probe.

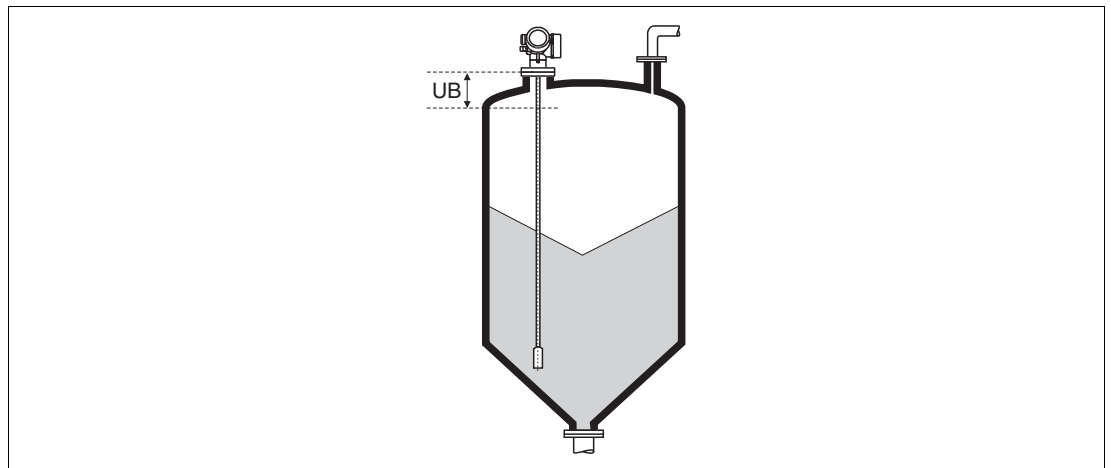



Figure 15.9 Blocking distance (UB) for bulk solid measurements



15.3.8 SIL/WHG confirmation wizard

SIL/WHG confirmation

Note: Wizard **SIL/WHG confirmation** wizard is only available for devices with SIL or WHG approval (Feature: "Additional approval", option A: "SIL" or C: "WHG overfill prevention") which are currently **not** in the SIL- or WHG-locked state. The **SIL/WHG confirmation** wizard is required to lock the device according to SIL or WHG. For details refer to the "Functional Safety Manual" of the respective device, which describes the locking procedure and the parameters of the sequence.

Navigation  Setup → Advanced setup → SIL/WHG confirm.

15.3.9 Deactivate SIL/WHG wizard

Deactivate SIL/WHG

Navigation  Setup → Advanced setup → Deactiv. SIL/WHG

Reset write protection

Blocking 

Navigation  Setup → Advanced setup → Deactiv. SIL/WHG → Res. write prot.

Description Enter unlocking code.

User entry 0 to 65535

Factory setting 0

Code incorrect

Blocking 

Navigation  Setup → Advanced setup → Deactiv. SIL/WHG → Code incorrect

Description Indicates that a wrong unlocking code has been entered. Select procedure.

Selection

- Reenter code
- Abort sequence

Factory setting Reenter code

15.3.10 Probe settings submenu

Probe settings

The **Probe settings** submenu helps to ensure that the end of probe signal within the envelope curve is correctly assigned by the evaluation algorithm. The assignment is correct if the length of probe indicated by the device matches the actual length of the probe. The automatic probe length correction can only be performed if the probe is installed in the vessel and is completely uncovered (no medium). For partially filled vessels and if the probe length is known, select **Confirm probe length** (page 130) = **Manual input** in order to enter the value manually.

Note: If a mapping (interference echo suppression) has been recorded after shortening the probe, it is no longer possible to perform an automatic probe length correction. In this case there are two options:

- Delete the map using the **Record map** parameter (page 106) before performing the automatic probe length correction. After the probe length correction, a new map can be recorded using the **Record map** parameter (page 106).
- Alternative: Select **Confirm probe length** (page 130) = **Manual input** and enter the probe length manually into the **Present probe length** parameter (page 129).

Note: An automatic probe length correction is only possible after the correct option has been selected in the **Probe grounded** parameter (page 129).

Navigation

☰ Setup → Advanced setup → Probe settings

Probe grounded

Blocking



Navigation

☰ Setup → Advanced setup → Probe settings → Probe grounded

Prerequisite

Operating mode = Level

Description

Specify whether the probe is grounded.

Selection

- No
- Yes

Factory setting

No

Present probe length

Blocking



Navigation

☰ Setup → Advanced setup → Probe settings → Pres. length

Description

- In most cases:
Displays the length of the probe according to the currently measured end-of-probe signal.
- For **Confirm probe length** (page 130) = **Manual input**:
Enter actual length of probe.



User entry

0 to 200 m

Factory setting

4 m

Confirm probe length

Blocking	
Navigation	 Setup → Advanced setup → Probe settings → Confirm length
Description	Select, whether the value displayed in the Present probe length parameter (page 129) matches the actual length of the probe. Based on this input, the device performs a probe length correction.
Selection	<ul style="list-style-type: none"> • Probe length OK • Probe length too small • Probe length too big • Probe covered • Manual input • Probe length unknown
Factory setting	Probe length OK
Additional information	<p>Meaning of the options</p> <ul style="list-style-type: none"> • Probe length OK To be selected if the indicated length is correct. An adjustment is not required. The device quits the sequence. • Probe length too small To be selected if the displayed length is smaller than the actual length of the probe. A different end of probe signal is allocated and the newly calculated length is displayed in the Present probe length parameter (page 129). This procedure has to be repeated until the displayed value matches the actual length of the probe. • Probe length too big To be selected if the displayed length is bigger than the actual length of the probe. A different end of probe signal is allocated and the newly calculated length is indicated in the Present probe length parameter (page 129). This procedure has to be repeated until the displayed value matches the actual length of the probe. • Probe covered To be selected if the probe is (partially or completely) covered. A probe length correction is impossible in this case. The device quits the sequence. • Manual input To be selected if no automatic probe length correction is to be performed. Instead, the actual length of the probe must be entered manually into the Present probe length parameter (page 129) ^a. • Probe length unknown To be selected if the actual length of the probe is unknown. A probe length correction is impossible in this case. The device quits the sequence.

^a When operated via PACTware, the **Manual input** option needs not to be selected explicitly. In PACTware the length of the probe can always be edited.



15.3.11 Probe length correction wizard

Probe length correction

Note: The **Probe length correction** wizard is only available when operating via the local display. When operating via an operating tool, all parameters concerning the probe length correction are located directly in the **Probe settings** submenu (page 129).

Navigation  Setup → Advanced setup → Probe settings → Prob.length corr

Confirm probe length

Blocking 

Navigation  Setup → Advanced setup → Probe settings → Prob.length corr → Confirm length

Description **Confirm probe length** (page 130)

Present probe length

Blocking 

Navigation  Setup → Advanced setup → Probe settings → Prob.length corr → Pres. length

Description **Present probe length** (page 129)



15.3.12 Switch output submenu

Switch output

Navigation  Setup → Advanced setup → Switch output

Switch output function

Blocking 

Navigation  Setup → Advanced setup → Switch output → Switch out funct

Description Select function for switch output.

- Selection**
- Off
 - On
 - Diagnostic behavior
 - Limit
 - Digital output



Factory setting Off

Additional information Meaning of the options



- **Off**
The output is always open (non-conductive).
- **On**
The output is always closed (conductive).
- **Diagnostic behavior**
The output is normally closed and is only opened if a diagnostic event is present. The **Assign diagnostic behavior** parameter (page 133) determines for which type of event the output is opened.
- **Limit**
The output is normally closed and is only opened if a measured variable exceeds or falls below a defined limit. The limit values are defined by the following parameters:
 - **Assign limit** (page 133)
 - **Switch-on value** (page 134)
 - **Switch-off value** (page 135)
- **Digital output**
The switching state of the output tracks the output value of a DI function block. The function block is selected in the **Assign status** parameter (page 133).

Note: The **Off** and **On** options can be used to simulate the switch output.

Assign status



Blocking	
Navigation	 Setup → Advanced setup → Switch output → Assign status
Prerequisite	Switch output function (page 132) = Digital Output
Description	Select device status for switch output.
Selection	<ul style="list-style-type: none">• Off• Digital output AD 1• Digital output AD 2• Digital output 1• Digital output 2• Digital output 3• Digital output 4
Factory setting	Off
Additional information	The Digital output AD 1 and Digital output AD 2 options refer to the Advanced Diagnostic Blocks.

Assign limit

Blocking	
Navigation	 Setup → Advanced setup → Switch output → Assign limit
Prerequisite	Switch output function (page 132) = Limit
Description	Select process variable for limit monitoring.
Selection	<ul style="list-style-type: none">• Off• Level linearized• Distance• Terminal voltage• Electronic temperature• Measured capacitance ^a• Relative echo amplitude• Absolute echo amplitude
Factory setting	Off

^a Visibility depends on order options or device settings

Assign diagnostic behavior

Blocking	
Navigation	 Setup → Advanced setup → Switch output → Assign diag. beh
Prerequisite	Switch output function (page 132) = Diagnostic behavior
Description	Select diagnostic behavior for switch output.
Selection	<ul style="list-style-type: none">• Alarm• Alarm or warning• Warning
Factory setting	Alarm



Switch-on value

Blocking	
Navigation	Setup → Advanced setup → Switch output → Switch-on value
Prerequisite	Switch output function (page 132) = Limit
Description	Enter measured value for the switch-on point.
User entry	Signed floating-point number
Factory setting	0
Additional information	The switching behavior depends on the relative position of the Switch-on value and Switch-off value parameters: Switch-on value > Switch-off value <ul style="list-style-type: none">• The output is closed if the measured value is larger than Switch-on value.• The output is opened if the measured value is smaller than Switch-off value.

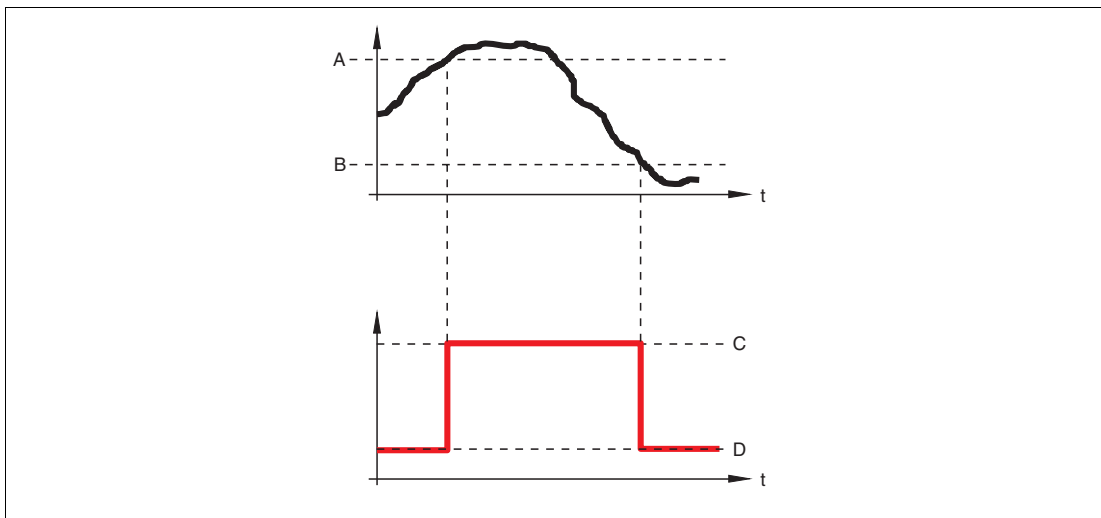

Figure 15.10

- A** Switch-on value
- B** Switch-off value
- C** Output closed (conductive)
- D** Output opened (non-conductive)

Switch-on value < Switch-off value

- The output is closed if the measured value is smaller than **Switch-on value**.
- The output is opened if the measured value is larger than **Switch-off value**.

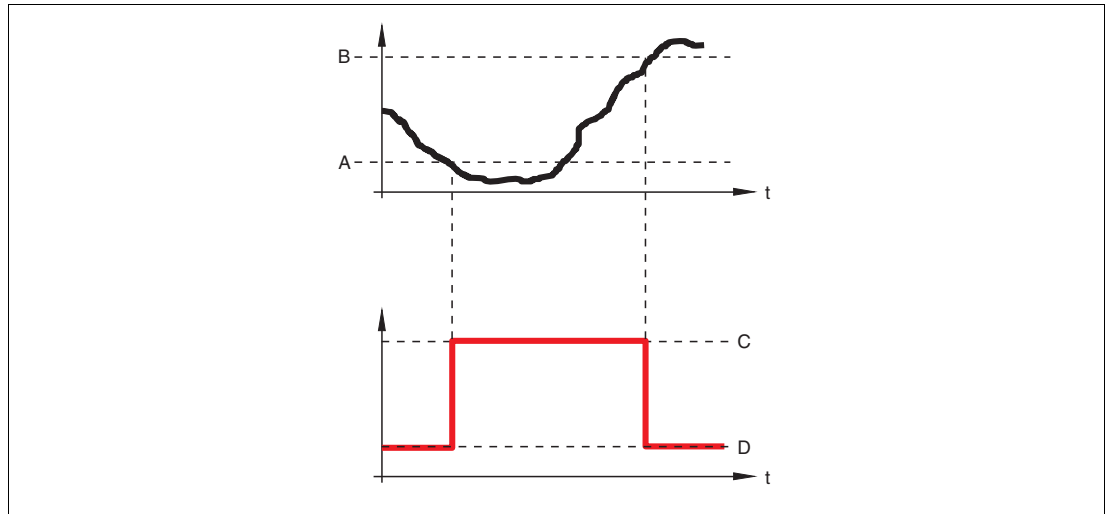

Figure 15.11

- A Switch-on value
- B Switch-off value
- C Output closed (conductive)
- D Output opened (non-conductive)

Switch-on delay

Blocking	
Navigation	Setup → Advanced setup → Switch output → Switch-on delay
Prerequisite	<ul style="list-style-type: none"> • Switch output function (page 132) = Limit • Assign limit (page 133) ≠ Off
Description	Define switch-on delay.
User entry	0.0 to 100.0 s
Factory setting	0.0 s

Switch-off value

Blocking	
Navigation	Setup → Advanced setup → Switch output → Switch-off value
Prerequisite	Switch output function (page 132) = Limit
Description	Enter measured value for the switch-off point.
User entry	Signed floating-point number
Factory setting	0
Additional information	The switching behavior depends on the relative position of the Switch-on value and Switch-off value parameters (description: see the Switch-on value parameter (page 134)).



Switch-off delay

Blocking	
Navigation	Setup → Advanced setup → Switch output → Switch-off delay
Prerequisite	<ul style="list-style-type: none">• Switch output function (page 132) = Limit• Assign limit (page 133) ≠ Off
Description	Define switch-off delay.
User entry	0.0 to 100.0 s
Factory setting	0.0 s

Failure mode

Blocking	
Navigation	Setup → Advanced setup → Switch output → Failure mode
Description	Define output behavior in alarm condition.
Selection	<ul style="list-style-type: none">• Actual status• Open• Closed
Factory setting	Open

Switch status

Navigation	Setup → Advanced setup → Switch output → Switch status
Description	Displays the current state of the switch output.
User interface	<ul style="list-style-type: none">• Open• Closed

Invert output signal

Blocking	
Navigation	Setup → Advanced setup → Switch output → Invert outp.sig.
Description	Specify whether the output signal is to be inverted.
Selection	<ul style="list-style-type: none">• No• Yes
Factory setting	No
Additional information	Meaning of the options <ul style="list-style-type: none">• No The behavior of the switch output is as described above.• Yes The states Open and Closed are inverted as compared to the description above.

15.3.13 Display submenu

Display

Note: The **Display** submenu is only visible if a display module is connected to the device.

Navigation

 Setup → Advanced setup → Display

Language

Navigation

 Setup → Advanced setup → Display → Language

Description

Set display language.

Selection ^a

- English
- Deutsch
- Français
- Español
- Italiano
- Nederlands
- Portuguesa
- Polski
- Russian
- Svenska
- Türkçe
- Chinese
- Japanese
- Korean
- Arabic
- Bahasa Indonesia
- Thai
- Vietnamese
- Czech

Factory setting

English

Additional information

The **English** option can be selected in every device. One additional operating language can be selected in the product structure when ordering a device (feature "Additional Operation Language") and will be selectable in the **Language** parameter.

^a Visibility depends on order options or device settings



Format display

Navigation

Setup → Advanced setup → Display → Format display

Description

Select how measured values are shown on the display.

Selection

- 1 value, max. size
- 1 bargraph + 1 value
- 2 values
- 1 value large + 2 values
- 4 values

Factory setting

1 value, max. size

Additional information

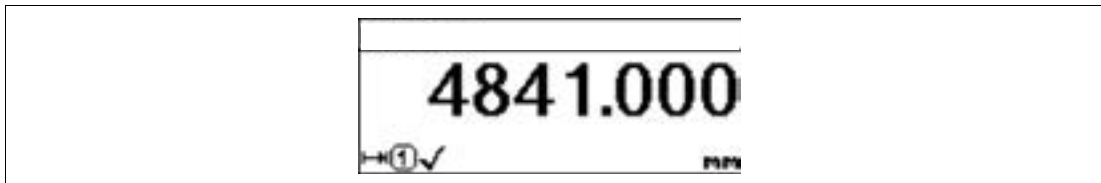

Figure 15.12 1 value, max. size

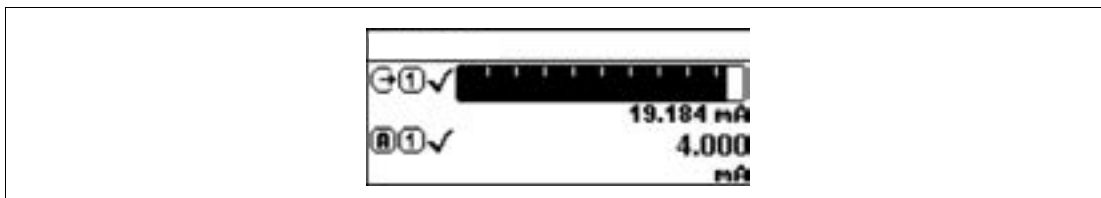

Figure 15.13 1 bargraph + 1 value

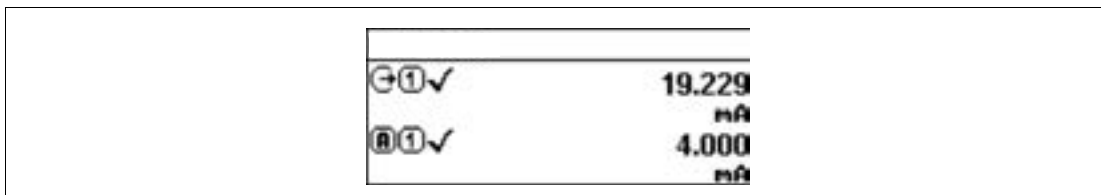

Figure 15.14 2 values

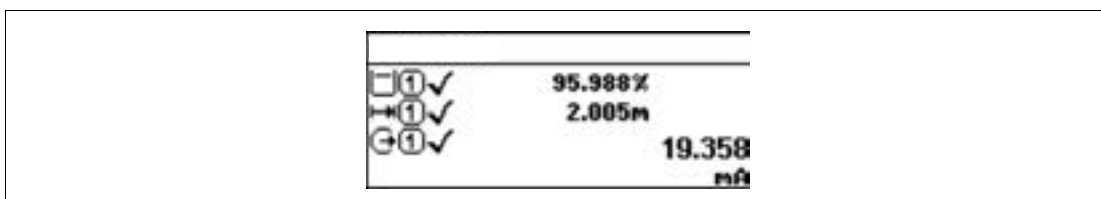

Figure 15.15 1 value large + 2 values

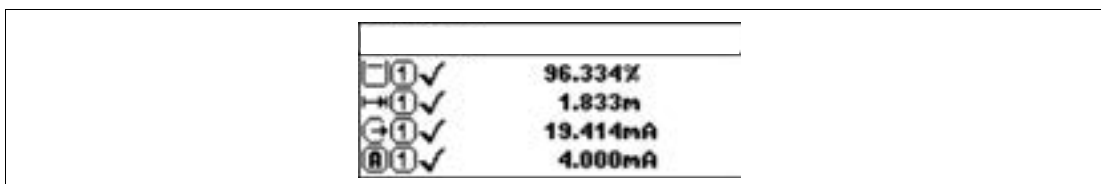



Figure 15.16 4 values

Note:

- The **Value 1 to 4 display** parameters (page 139) specify which measured values are shown on the display and in which order.
- If more measured values are specified than the current display mode permits, the values alternate on the device display. The display time until the next change is configured in the **Display interval** parameter (page 140).



Value 1 to 4 display

Blocking	
Navigation	 Setup → Advanced setup → Display → Value 1 display
Description	Select the measured value that is shown on the local display.
Selection	<ul style="list-style-type: none"> • None ^a • Level linearized • Distance • Current output 1 ^b • Measured current • Current output 2 • Terminal voltage • Electronic temperature • Analog output adv diagnostics 1 • Analog output adv diagnostics 2
Factory setting	<p>For level measurements</p> <ul style="list-style-type: none"> • Value 1 display: Level linearized • Value 2 display: Distance • Value 3 display: Current output 1 • Value 4 display: None

^a can not be selected for the **Value 1 display** parameter

^b Visibility depends on order options or device settings

Decimal places 1 to 4

Blocking	
Navigation	 Setup → Advanced setup → Display → Decimal places 1
Description	Select the number of decimal places for the display value.
Selection	<ul style="list-style-type: none"> • x • x.x • x.xx • x.xxx • x.xxxx
Factory setting	x.xx
Additional information	The setting does not affect the accuracy of the measurement or the calculations.



Display interval

Navigation	Setup → Advanced setup → Display → Display interval
Description	Set time measured values are shown on display if display alternates between values.
User entry	1 to 10 s
Factory setting	5 s
Additional information	The Display interval parameter is only relevant if the number of measured values defined exceeds the number of values the selected display format can display simultaneously.

Display damping

Blocking	
Navigation	Setup → Advanced setup → Display → Display damping
Description	Define display reaction time to fluctuations in the measured value.
User entry	0.0 to 999.9 s
Factory setting	0.0 s

Header

Blocking	
Navigation	Setup → Advanced setup → Display → Header
Description	Select header contents on local display.
Selection	<ul style="list-style-type: none"> • Device tag • Free text
Factory setting	Device tag
Additional information	<p>Meaning of the options</p> <ul style="list-style-type: none"> • Device tag Is defined in the Device tag parameter (page 101). • Free text Is defined in the Header text parameter (page 141).

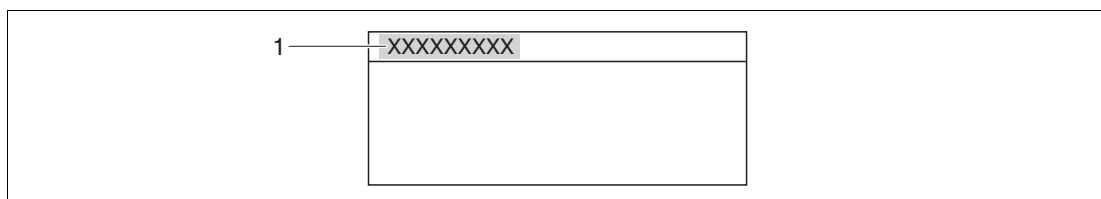





Figure 15.17

- 1 Position of the header text on the display



Header text

Blocking	
Navigation	 Setup → Advanced setup → Display → Header text
Prerequisite	Header (page 140) = Free text
Description	Enter display header text.
Factory setting	_____
Additional information	The number of characters displayed depends on the characters used.



Separator

Blocking	
Navigation	 Setup → Advanced setup → Display → Separator
Description	Select decimal separator for displaying numerical values.
Selection	<ul style="list-style-type: none"> • . • ,
Factory setting	.

Number format

Blocking	
Navigation	 Setup → Advanced setup → Display → Number format
Description	Choose number format for the display.
Selection	<ul style="list-style-type: none"> • Decimal • ft-in-1/16"
Factory setting	Decimal
Additional information	The ft-in-1/16" option is only valid for distance units.

Decimal places menu

Blocking	
Navigation	 Setup → Advanced setup → Display → Dec. places menu
Description	Select number of decimal places for the representation of numbers within the operating menu.
Selection	<ul style="list-style-type: none"> • x • x.x • x.xx • x.xxx • x.xxxx
Factory setting	x.xxxx
Additional information	<ul style="list-style-type: none"> • Is only valid for numbers in the operating menu (e. g. Empty calibration, Full calibration), but not for the measured value display. The number of decimal places for the measured value display is defined in the Decimal places 1 to 4 parameters (page 139). • The setting does not affect the accuracy of the measurement or the calculations.



Backlight

Navigation	Setup → Advanced setup → Display → Backlight
Prerequisite	The device has the SD03 local display (with optical keys).
Description	Switch the local display backlight on and off.
Selection	<ul style="list-style-type: none">• Disable• Enable
Factory setting	Disable
Additional information	Meaning of the options <ul style="list-style-type: none">• Disable Switches the backlight off.• Enable Switches the backlight on. <p>Note: Regardless of the setting in this parameter the backlight may be automatically switched off by the device if the supply voltage is too low.</p>

Contrast display

Navigation	Setup → Advanced setup → Display → Contrast display
Description	Adjust local display contrast setting to ambient conditions (e. g. lighting or reading angle).
User entry	20 to 80 %
Factory setting	Dependent on the display.
Additional information	<p>Note: Setting the contrast via push-buttons:</p> <ul style="list-style-type: none">• Darker: Press the and buttons simultaneously.• Brighter: Press the and buttons simultaneously.

15.3.14 Configuration backup display submenu

Configuration backup display

Note: This submenu is only visible if a display module is connected to the device. The configuration of the device can be saved to the display module at a certain point of time (backup). The saved configuration can be restored to the device if required, e. g. in order to bring the device back into a defined state. The configuration can also be transferred to a different device of the same type using the display module.

Navigation  Setup → Advanced setup → Conf.backup disp

Operating time

Navigation  Setup → Advanced setup → Conf.backup disp → Operating time

Description Indicates how long the device has been in operation.

User interface Days (d), hours (h), minutes (m), seconds (s)

Additional information Maximum time: 9999 d (≈ 27 years)

Last backup

Navigation  Setup → Advanced setup → Conf.backup disp → Last backup

Description Indicates when the last data backup was saved to the display module.

User interface Days (d), hours (h), minutes (m), seconds (s)



Configuration management

Blocking	
Navigation	Setup → Advanced setup → Conf.backup disp → Config. managem.
Description	Select action for managing the device data in the display module.
Selection	<ul style="list-style-type: none"> • Cancel • Execute backup • Restore • Duplicate • Compare • Clear backup data
Factory setting	Cancel
Additional information	<p>Meaning of the options</p> <ul style="list-style-type: none"> • Cancel No action is executed and the user exits the parameter. • Execute backup A backup copy of the current device configuration in the HistoROM (built-in in the device) is saved to the display module of the device. • Restore The last backup copy of the device configuration is copied from the display module to the HistoROM of the device. • Duplicate The transmitter configuration is duplicated to another device using the transmitter display module. The following parameters, which characterize the individual measuring point are not included in the transmitted configuration: medium type. • Compare The device configuration saved in the display module is compared to the current device configuration of the HistoROM. The result of this comparison is displayed in the Comparison result parameter (page 145). • Clear backup data The backup copy of the device configuration is deleted from the display module of the device. <p>Note: While this action is in progress, the configuration cannot be edited via the local display and a message on the processing status appears on the display.</p> <p>Note: If an existing backup is restored to a different device using the Restore option, it may occur that some device functionalities are no longer available. In some cases even a device reset will not restore the original status (page 147). In order to transmit a configuration to a different device, the Duplicate option should always be used.</p>

Backup state

Navigation	Setup → Advanced setup → Conf.backup disp → Backup state
Description	Displays which backup action is currently in progress.

Comparison result

Navigation	 Setup → Advanced setup → Conf.backup disp → Compar. result
Description	Displays the comparison result between the device and the display.
Additional information	<p>Meaning of the display options</p> <ul style="list-style-type: none">• Settings identical The current device configuration of the HistoROM is identical to the backup copy in the display module.• Settings not identical The current device configuration of the HistoROM is not identical to the backup copy in the display module.• No backup available There is no backup copy of the device configuration of the HistoROM in the display module.• Backup settings corrupt The current device configuration of the HistoROM is corrupt or not compatible with the backup copy in the display module.• Check not done The device configuration of the HistoROM has not yet been compared to the backup copy in the display module.• Dataset incompatible The data sets are incompatible and can not be compared. <p>Note: To start the comparison, set Configuration management (page 144) = Compare.</p> <p>Note: If the transmitter configuration has been duplicated from a different device by Configuration management (page 144) = Duplicate, the new device configuration in the HistoROM is only partially identical to the configuration stored in the display module: Sensor specific properties (e. g. the mapping curve) are not duplicated. Thus, the result of the comparison will be Settings not identical.</p>



15.3.15 Administration submenu

Administration

Navigation  Setup → Advanced setup → Administration

Define access code



Blocking 

Navigation  Setup → Advanced setup → Administration → Def. access code



Description Define release code for write access to parameters.

User entry 0 to 9999

Factory setting 0

Additional information **Note:** If the factory setting is not changed or 0 is defined as the access code, the parameters are not write-protected and the configuration data of the device can then always be modified. The user is logged on in the Maintenance role.
Note: The write protection affects all parameters marked with the  symbol in this document. On the local display, the  symbol in front of a parameter indicates that the parameter is write-protected.
Note: Once the access code has been defined, write-protected parameters can only be modified if the access code is entered in the **Enter access code** parameter (page 111).
Note: Please contact your Pepperl+Fuchs Sales Center if you lose your access code.
Note: For display operation: The new access code is only valid after it has been confirmed in the **Confirm access code** parameter (page 148).

Device reset

Blocking	
Navigation	 Setup → Advanced setup → Administration → Device reset
Description	Select to which state the device is to be reset.
Selection	<ul style="list-style-type: none">• Cancel• To factory defaults• To delivery settings• Of customer settings• To transducer defaults• Restart device
Factory setting	Cancel
Additional information	Meaning of the options <ul style="list-style-type: none">• Cancel No action.• To factory defaults All parameters are reset to the order-code specific factory setting.• To delivery settings All parameters are reset to the delivery setting. The delivery setting may differ from the factory default if customer specific settings have been ordered. This option is only visible if customer specific settings have been ordered.• Of customer settings All customer parameters are reset to their factory setting. Service parameters, however, remain unchanged.• To transducer defaults Every measurement-related parameter is reset to its factory setting. Service parameters and communication-related parameters, however, retain their current value.• Restart device The restart resets every parameter which is stored in the volatile memory (RAM) to the factory setting (e. g. measured value data). The device configuration remains unchanged.



15.3.16 Define access code wizard

Define access code

Note: The **Define access code** wizard is only available when operating via the local display. When operating via an operating tool, the **Define access code** parameter is located directly in the **Administration** submenu. The **Confirm access code** parameter is not available for operation via operating tool.

Navigation  Setup → Advanced setup → Administration → Def. access code

Define access code

Blocking 

Navigation  Setup → Advanced setup → Administration → Def. access code
→ Def. access code

Description **Define access code** (page 146)

Confirm access code

Blocking 

Navigation  Setup → Advanced setup → Administration → Def. access code
→ Confirm code

Description Confirm the entered access code.

User entry 0 to 9999

Factory setting 0

15.4 Diagnostics menu

Diagnostics

Navigation  Diagnostics

Actual diagnostics

Navigation  Diagnostics → Actual diagnos.

Description Displays current diagnostic message.

Additional information The display consists of:

- Symbol for event behavior
- Code for diagnostic behavior
- Operating time of occurrence
- Event text

Note: If several messages are active at the same time, the messages with the highest priority is displayed.

Note: Information on what is causing the message, and remedy measures, can be viewed via the  symbol on the display.

Timestamp

Navigation  Diagnostics → Timestamp

Description Displays timestamp for the **Actual diagnostics** parameter (page 149).

User interface Days (d), hours (h), minutes (m), seconds (s)

Previous diagnostics

Navigation  Diagnostics → Prev.diagnostics

Description Displays the last diagnostic message which has been active before the current message.

Additional information The display consists of:

- Symbol for event behavior
- Code for diagnostics behavior
- Operating time of occurrence
- Event text

Note: The condition displayed may still apply. Information on what is causing the message, and remedy measures, can be viewed via the  symbol on the display.

Timestamp

Navigation  Diagnostics → Timestamp

Description Displays timestamp for the **Previous diagnostics** parameter (page 149).

User interface Days (d), hours (h), minutes (m), seconds (s)



Operating time from restart

- Navigation**  Diagnostics → Time fr. restart
- Description** Displays the time the device has been in operation since the last device restart.
- User interface** Days (d), hours (h), minutes (m), seconds (s)

Operating time

- Navigation**  Diagnostics → Operating time
- Description** Indicates how long the device has been in operation.
- User interface** Days (d), hours (h), minutes (m), seconds (s)
- Additional information** Maximum time: 9999 d (\approx 27 years)



15.4.1 Diagnostic list submenu

Diagnostic list

Navigation  Diagnostics → Diagnostic list

Diagnostics 1 to 5

Navigation  Diagnostics → Diagnostic list → Diagnostics 1 to 5

Description Display the current diagnostics messages with the highest to fifth-highest priority.

Additional information The display consists of:

- Symbol for event behavior
- Code for diagnostic behavior
- Operating time of occurrence
- Event text

Timestamp 1 to 5

Navigation  Diagnostics → Diagnostic list → Timestamp

Description Displays timestamp for the **Diagnostics 1 to 5** parameter (page 151).

User interface Days (d), hours (h), minutes (m), seconds (s)



15.4.2 Event logbook submenu

Event logbook

Note: The **Event logbook** submenu is only available when operating via the local display. When operating via PACTware, the event list can be displayed in the PACTware function **Event List/HistoROM**.

Navigation Diagnostics → Event logbook

Filter options

Blocking

Navigation Diagnostics → Event logbook → Filter options

Description Select category (status signal) whose event messages are displayed in the events list.

- Selection**
- All
 - Failure (F)
 - Function check (C)
 - Out of specification (S)
 - Maintenance required (M)
 - Information (I)

Factory setting All

- Additional information**
- This parameter is used only when operating via the local display.
 - The status signals are categorized according to NAMUR NE 107.

15.4.3 Event list submenu

Event list

The **Event list** submenu displays the history of past events of the category selected in the **Filter options** parameter (page 152). A maximum of 20 events are displayed in chronological order. If the advanced HistoROM functionality has been activated in the device, the event list may comprise up to 100 entries.

The following symbols indicate whether an event has occurred or has ended:

- : Event has occurred
- : Event has ended

Note: Information on what is causing the message, and remedy measures, can be viewed via the button.

Display format

- For event messages in category I: information event, event text, "recording event" symbol and time the event occurred
- For event messages in category F, M, C, S (status signal): diagnostics event, event text, "recording event" symbol and time the event occurred

Navigation Diagnostics → Event logbook → Event list

15.4.4 Device information submenu

Device information

Navigation  Diagnostics → Device info

Device tag

Navigation  Diagnostics → Device info → Device tag

Description Enter tag for measuring point.

Factory setting LTC5X

Serial number

Navigation  Diagnostics → Device info → Serial number

Description Displays serial number of the device.

Additional information **Note:** Uses of the serial number

- To identify the device quickly, e. g. when contacting Pepperl+Fuchs.
- To obtain specific information on the device: See www.pepperl-fuchs.com.

Note: The serial number is also indicated on the nameplate.

Firmware version

Navigation  Diagnostics → Device info → Firmware version

Description Displays Firmware version of the device.

User interface xx.yy.zz

Additional information **Note:** For firmware versions differing only in the last two digits ("zz") there is no difference concerning functionality or operation.

Device name

Navigation  Diagnostics → Device info → Device name

Description Displays device name.

Order code

Navigation  Diagnostics → Device info → Order code

Description Displays order code of the device.

Additional information The order code is generated from the extended order code, which defines all device features of the product structure. In contrast, the device features can not be read directly from the order code.



Extended order code 1 to 3

- Navigation**  Diagnostics → Device info → Ext. order cd. 1 to 3
- Description** Display the three parts of the extended order code.
- Additional information** The extended order code indicates the version of all the features of the product structure and thus uniquely identifies the device.

Status PROFIBUS Master Config

- Navigation**  Diagnostics → Device info → Stat Master Conf
- Description** Indicates whether PROFIBUS master configuration is active for the device.
- User interface**
- Active
 - Not active

PROFIBUS ident number

- Navigation**  Diagnostics → Device info → Ident number
- Description** Indicates the ident number of the device.
- Additional information** The **Ident number selector** parameter can be used to define which ident number is used.

15.4.5 Measured values submenu

Measured values

Navigation  Diagnostics → Measured val.

Distance

Navigation  Diagnostics → Measured val. → Distance

Description Displays the measured distance D_L between the reference point (lower edge of the flange or threaded connection) and the level.

Additional information **Note:** The unit is defined in the **Level unit** parameter (page 101).

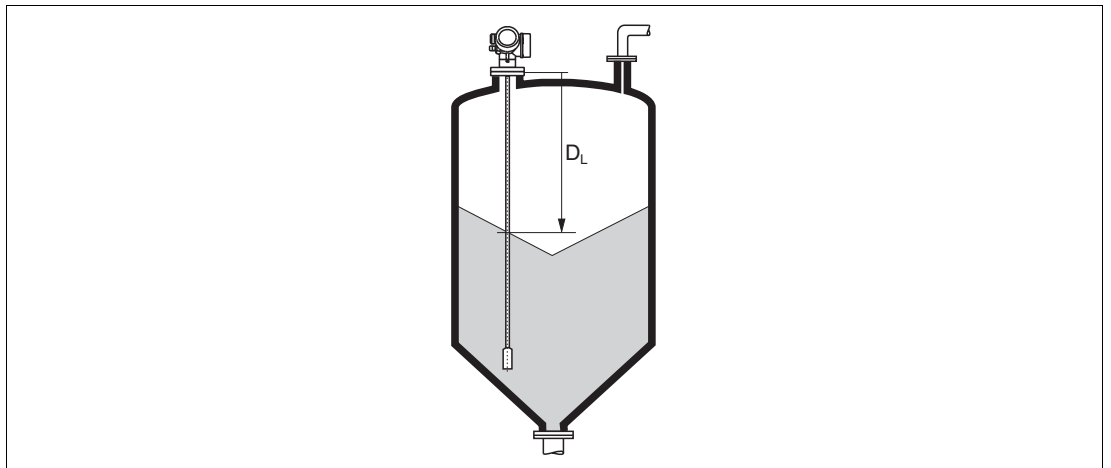



Figure 15.18 Distance for bulk solid measurements

Level linearized

Navigation  Diagnostics → Measured val. → Level linearized

Description Displays linearized level.

Additional information **Note:** The unit is defined by the **Unit after linearization** parameter (page 118).

Terminal voltage 1

Navigation  Diagnostics → Measured val. → Terminal volt. 1

Description Displays terminal voltage at the output.

Switch status

Navigation  Diagnostics → Measured val. → Switch status

Description Displays the current state of the switch output.



15.4.6 Analog input 1 to 6 submenu

Analog input 1 to 6

Note: There is an **Analog input** submenu for each AI block of the device. The AI block is used to configure the measured value transmission to the bus. Only the most basic properties of the AI blocks can be configured in this submenu. For a detailed configuration of the AI blocks refer to Expert → Analog inputs → Analog input 1 to 6.

Navigation Diagnostics → Analog inputs → Analog input 1 to 6

Channel

Blocking

Navigation Diagnostics → Analog inputs → Analog input 1 to 6 → Channel

Description Standard parameter **CHANNEL** of the Analog Input Block according to the PROFIBUS profile.

Selection

- Level linearized
- Distance
- Terminal voltage
- Electronic temperature
- Measured capacitance ^a
- Absolute echo amplitude
- Relative echo amplitude
- Absolute EOP amplitude
- Noise of signal
- EOP shift
- Calculated DC value ^b
- Sensor debug
- Analog output adv. diagnostics 1
- Analog output adv. diagnostics 2

Factory setting Level linearized

Additional information Allocates a measured value to the AI block.

^a Visibility depends on order options or device settings

^b Visibility depends on order options or device settings

Out value

Navigation Diagnostics → Analog inputs → Analog input 1 to 6 → Out value

Description Element **Value** of the standard parameter **OUT** in the Analog Input Block according to the PROFIBUS profile.

User entry Signed floating-point number

Factory setting 0

Additional information

- For **Mode block actual = Man**: Enter the output value of the Analog Input Block.
- Else: Displays the output value of the Analog Input Block.



Out status

Navigation	Diagnostics → Analog inputs → Analog input 1 to 6 → Out status
Description	Element Status of the standard parameter OUT in the Analog Input Block according to the PROFIBUS profile.
Factory setting	<ul style="list-style-type: none">• Good• Uncertain• Bad
Additional information	Only the two quality bits are evaluated in this parameter.

Out status HEX

Navigation	Diagnostics → Analog inputs → Analog input 1 to 6 → Out status HEX
Description	Element Status of the standard parameter OUT in the Analog Input Block according to the PROFIBUS profile.
User entry	0 to 255
Factory setting	128
Additional information	The complete status byte is displayed in the form of a two-digit hexadecimal number in this parameter.



15.4.7 Data logging submenu

Data logging

Note: The **Data logging** submenu is only available if the advanced functionality of the HistoROM has been activated in the device.

Navigation  Diagnostics → Data logging

Assign channel 1 to 4

Blocking 

Navigation  Diagnostics → Data logging → Assign chan. 1 to 4

Description Allocate a process variable to the respective data logging channel.

- Selection**
- Off
 - Level linearized
 - Distance
 - Unfiltered distance
 - Terminal voltage
 - Electronic temperature
 - Measured capacitance ^a
 - Absolute echo amplitude
 - Relative echo amplitude
 - Absolute EOP amplitude
 - EOP shift
 - Noise of signal
 - Calculated DC value ^b
 - Analog output adv. diagnostics 1
 - Analog output adv. diagnostics 2

Factory setting Off

Additional information A total of 500 measured values can be logged. This means:

- 500 data points if 1 logging channel is used
- 250 data points if 2 logging channels are used
- 166 data points if 3 logging channels are used
- 125 data points if 4 logging channels are used



If the maximum number of data points is reached, the oldest data points in the data log are cyclically overwritten in such a way that the last 500, 250, 166 or 125 measured values are always in the log (ring memory principle).

Note: The logged data are deleted if a new option is selected in this parameter.

^a Visibility depends on order options or device settings

^b Visibility depends on order options or device settings

Logging interval



Blocking	
Navigation	 Diagnostics → Data logging → Logging interval
Description	Define logging interval t_{log} .
User entry	1.0 to 3600.0 s
Factory setting	30.0 s
Additional information	<p>This parameter defines the interval between the individual data points in the data log, and thus the maximum loggable process time T_{log}:</p> <ul style="list-style-type: none"> • If 1 logging channel is used: $T_{log} = 500 \times t_{log}$ • If 2 logging channels are used: $T_{log} = 250 \times t_{log}$ • If 3 logging channels are used: $T_{log} = 166 \times t_{log}$ • If 4 logging channels are used: $T_{log} = 125 \times t_{log}$ <p>Once this time elapses, the oldest data points in the data log are cyclically overwritten such that a time of T_{log} always remains in the memory (ring memory principle).</p> <p>Note: The logged data are deleted if this parameter is changed.</p>

Example

When using 1 logging channel

- $T_{log} = 500 \times 1 \text{ s} = 500 \text{ s} \approx 8.5 \text{ min}$
- $T_{log} = 500 \times 10 \text{ s} = 5000 \text{ s} \approx 1.5 \text{ h}$
- $T_{log} = 500 \times 80 \text{ s} = 40000 \text{ s} \approx 11 \text{ h}$
- $T_{log} = 500 \times 3600 \text{ s} = 1800000 \text{ s} \approx 20 \text{ d}$

Clear logging data

Blocking	
Navigation	 Diagnostics → Data logging → Clear logging
Description	Initiate a deletion of the complete logging memory.
Selection	<ul style="list-style-type: none"> • Cancel • Clear data
Factory setting	Cancel



15.4.8 Display channel 1 to 4 submenu

Display channel 1 to 4

Note: The **Display channel 1 to 4** submenu is only available for operation via the local display. When operating via PACTware, the logging diagram can be displayed in the PACTware function **Event List/HistoROM**.

The **Display channel 1 to 4** submenu invokes a diagram of the logging history of the respective channel.

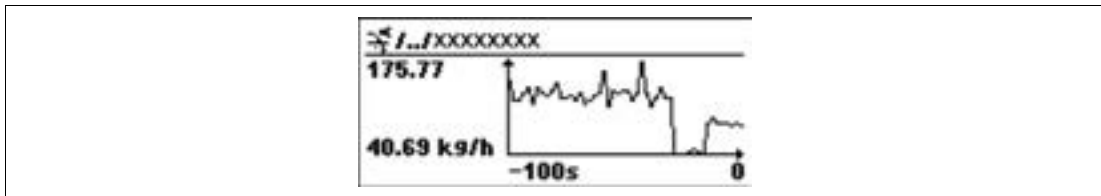

Figure 15.19

- X-axis: Depending on the number of selected channels, 250 to 1000 measured values of a process variable are displayed.
- Y-axis: Covers the approximate measured value span and constantly adapts this to the measurement.

Note: To return to the operating menu, press and simultaneously.

Navigation

Diagnostics → Data logging → Display chan. 1 to 4

15.4.9 Simulation submenu

Simulation

Navigation  Diagnostics → Simulation

Assign measurement variable

Blocking 

Navigation  Diagnostics → Simulation → Assign meas.var.

Description Select process variable to be simulated.

Selection

- Off
- Level
- Level linearized

Factory setting Off

Additional information

- The value of the variable to be simulated is defined in the **Value process variable** parameter (page 161).
- If **Assign measurement variable** ≠ **Off**, a simulation is active. This is indicated by a diagnostic message of the **Function check (C)** category.

Value process variable

Blocking 

Navigation  Diagnostics → Simulation → Value proc. var.

Prerequisite **Assign measurement variable** (page 161) ≠ **Off**

Description Specify value of the process value being simulated.

User entry Signed floating-point number

Factory setting 0

Additional information Downstream measured value processing and the signal output use this simulation value. In this way, users can verify whether the measuring device has been configured correctly.

Switch output simulation

Blocking 

Navigation  Diagnostics → Simulation → Switch sim.

Description Switch the simulation of the switch output on or off.

Selection

- Off
- On

Factory setting Off



Switch status

Blocking	
Navigation	Diagnostics → Simulation → Switch status
Prerequisite	Switch output simulation (page 161) = On
Description	Define the switch state to be simulated.
Selection	<ul style="list-style-type: none">• Open• Closed
Factory setting	Open
Additional information	The switch status assumes the value defined in this parameter. This helps to check correct operation of connected control units.

Simulation device alarm

Blocking	
Navigation	Diagnostics → Simulation → Sim. alarm
Description	Switch alarm simulation on or off.
Selection	<ul style="list-style-type: none">• Off• On
Factory setting	Off
Additional information	When selecting the On option, the device generates an alarm. This helps to check the correct output behavior of the device in the case of an alarm. An active simulation is indicated by a diagnostic message of the Function check (C) category.

Diagnostic event category

Navigation	Diagnostics → Simulation → Event category
Prerequisite	Access status display (page 111)/ Access status tooling (page 110) = Service
Description	Select event category for the simulation.
Selection	<ul style="list-style-type: none">• Sensor• Electronics• Configuration• Process
Factory setting	Process
Additional information	Only events of the selected category are available in the selection list of the Simulation diagnostic event parameter (page 163). When operated via tool, all diagnostic messages are always available in Simulation diagnostic event parameter. Therefore, Diagnostic event category parameter appears only on the local display.



Simulation diagnostic event

Navigation	 Diagnostics → Simulation → Sim. diag event
Prerequisite	Access status display (page 111)/ Access status tooling (page 110) = Service
Description	Select diagnostic event to be simulated.
Factory setting	Off
Additional information	When operated via the local display, the selection list can be filtered according to the event categories (Diagnostic event category parameter see page 162)).



15.4.10 Device check submenu

Device check

Navigation  Diagnostics → Device check

Start device check

Blocking 

Navigation  Diagnostics → Device check → Start dev. check

Description Start a device check.

Selection

- No
- Yes

Factory setting No

Additional information In the case of a lost echo a device check can not be performed.

Result device check

Navigation  Diagnostics → Device check → Result dev.check

Description Displays the result of the device check.

Additional information Meaning of the display options

- **Installation OK**
Measurement possible without restrictions.
- **Accuracy reduced**
A measurement is possible. However, the measuring accuracy may be reduced due to the signal amplitudes.
- **Measurement capability reduced**
A measurement is currently possible. However, there is the risk of an echo loss. Check the mounting position of the device and the dielectric constant of the medium.
- **Check not done**
No device check has been performed.

Last check time

Navigation  Diagnostics → Device check → Last check time

Description Displays the operating time at which the last device check has been performed.

Level signal

Navigation  Diagnostics → Device check → Level signal

Prerequisite Device check has been performed.

Description Displays result of the device check for the level signal.

User interface

- Check not done
- Check not OK
- Check OK

Additional information For **Level signal = Check not OK**: Check the mounting position of the device and the dielectric constant of the medium.



Launch signal

Navigation	 Diagnostics → Device check → Launch signal
Prerequisite	Device check has been performed.
Description	Displays result of the display check for the launch signal.
User interface	<ul style="list-style-type: none">• Check not done• Check not OK• Check OK
Additional information	For Launch signal = Check not OK : Check the mounting position of the device. In non-metallic vessels use a metal plate or a metal flange.



A	
Access authorization to parameters	52
Access code	52
Access status display (parameter)	111
Access status tooling (parameter)	110
Activate table (parameter)	123
Actual diagnostics (parameter)	149
Administration (submenu)	146
Advanced process conditions (parameter)	114
Advanced setup (submenu)	110
Analog input 1 to 6 (submenu)	108, 156
Application	11
Assign channel 1 to 4 (parameter)	158
Assign diagnostic behavior (parameter)	133
Assign limit (parameter)	133
Assign measurement variable (parameter)	161
Assign status (parameter)	133
B	
Backlight (parameter)	142
Backup state (parameter)	144
Basic safety instructions	11
Bin type (parameter)	101
Blocking distance (parameter)	115, 127
C	
CE mark	12
Channel (parameter)	108, 156
Clear logging data (parameter)	159
Code incorrect (parameter)	128
Comparison result (parameter)	145
Configuration backup display (submenu)	143
Configuration management (parameter)	144
Confirm access code (parameter)	148
Confirm distance (parameter)	105, 107
Confirm probe length (parameter)	131
Confirm probe length parameter)	130
Context menu	63
Contrast display (parameter)	142
Customer value (parameter)	122, 124

D

Data logging (submenu)	158
Deactivate SIL/WHG (wizard)	128
Deactivating write protection	54
Decimal places 1 to 4 (parameter)	139
Decimal places menu (parameter)	141
Declaration of Conformity	12
Define access code	53
Define access code (parameter)	146, 148
Define access code (wizard)	148
Define write protection	53
Design	13
Designated use	11
Designated use, borderline cases	11
Designated use, incorrect use	11
Designated use, residual risk	12
Device address	65
Device address (parameter)	101
Device check (submenu)	164
Device database files (GSD)	65
Device information (submenu)	153
Device name (parameter)	153
Device reset (parameter)	147
Device tag (parameter)	101, 153
Diagnostic event	77
Diagnostic event category (parameter)	162
Diagnostic list	78
Diagnostic list (submenu)	151
Diagnostic message	74
Diagnostics (menu)	149
Diagnostics 1 to 5 (parameter)	151
Diagnostics event	75
Diagnostics menu	149
Diameter (parameter)	119
DIP switch	54
Disabling write protection	53
Display (submenu)	137
Display channel 1 to 4 (submenu)	160
Display damping (parameter)	140
Display interval (parameter)	140
Display module	57
Display symbols	58



Disposal	86
Distance (parameter)	103, 107, 155
Distance unit (parameter)	101
Document function	6
E	
Edit table (submenu)	124
Electronics housing	14
Empty calibration (parameter)	102
Enabling the keylock	56
Enter access code (parameter)	111
Envelope curve display	64
Event history	81
Event level, explanation	74
Event list	81
Event list (submenu)	152
Event logbook (submenu)	152
Event text	75
Extended order code 1 to 3 (parameter)	154
Exterior cleaning	84
F	
Fail safe type (parameter)	109
Fail safe value (parameter)	109
Failure mode (parameter)	136
Filter options (parameter)	152
Filtering the event logbook	81
Firmware version (parameter)	153
Flange	36
Format display (parameter)	138
Free text (parameter)	118
Full calibration (parameter)	102
H	
Header (parameter)	140
Header text (parameter)	141
Heat insulation	33
Housing design	14
I	
Input mask	61
Intermediate height (parameter)	120
Invert output signal (parameter)	136

L

Language (parameter)	137
Last backup (parameter)	143
Last check time (parameter)	164
Launch signal (parameter)	165
Level (Manual) (parameter)	122
Level (parameter)	103, 124
Level (Semi-automatic) (parameter)	122
Level (submenu)	112
Level correction (parameter)	115
Level linearized (parameter)	118, 155
Level measurement configuration	68
Level signal (parameter)	164
Level unit (parameter)	114
Linearization (submenu)	116
Linearization type (parameter)	116
Local display	57
Local operation	49
Lock switch	54
Locking state	58
Locking status (parameter)	110
Logging interval (parameter)	159

M

Maintenance	84
Mapping end point (parameter)	106, 107
Mapping wizard (wizard)	107
Maximum value (parameter)	119
Measured materials	11
Measured value symbols	59
Measured values (submenu)	155
Medium property (parameter)	112
Medium type (parameter)	112
Menu, structure	51
Mounting position for level measurements	20

N

Non-metallic vessels	32
Number format (parameter)	141

O

Operating elements	60
Operating elements for diagnostics message	75
Operating menu	51



Operating module	57
Operating time (parameter)	143, 150
Operating time from restart (parameter)	150
Operational safety	12
Order code (parameter)	153
Out status (parameter)	157
Out status HEX (parameter)	157
Out value (parameter)	156
Output echo lost (parameter)	125
Overvoltage protection	45
P	
Present mapping (parameter)	106
Present probe length (parameter)	129, 131
Previous diagnostics (parameter)	149
Probe grounded (parameter)	129
Probe length correction (wizard)	131
Probe settings (submenu)	129
Process property (parameter)	113
Product safety	12
PROFIBUS ident number (parameter)	154
PROFIBUS network	65
PV filter time (parameter)	108
R	
Ramp at echo lost (parameter)	126
Record map (parameter)	106, 107
Registered trademarks	15
Remedial measures	76
Remote operation	49
Repair concept	85
Replacing a device	85
Requirements for the personnel	11
Reset write protection (parameter)	128
Result device check (parameter)	164
Return	86
Rod probe, design	13
Rod probes, bending strength	26
Rod probes, shortening	34
Rope probe, design	13
Rope probes, mounting	37
Rope probes, shortening	35
Rope probes, tensile load	23

S

Safety settings (submenu)	125
Securing rod probes	30
Securing rope probes	29
Separator (parameter)	141
Serial number (parameter)	153
Service interface (CDI)	50
Setting the operating language	67
Settings, manage device configuration	71
Setup (menu)	101
Signal quality (parameter)	104
SIL/WHG confirmation (wizard)	128
Simulation (submenu)	161
Simulation device alarm (parameter)	162
Simulation diagnostic event (parameter)	163
Software addressing	66
Spare parts	86
Start device check (parameter)	164
Status display for diagnostic message	74
Status PROFIBUS Master Config (parameter)	154
Status signals	58, 74
Switch output (submenu)	132
Switch output function (parameter)	132
Switch output simulation (parameter)	161
Switch status (parameter)	136, 155, 162
Switch-off delay (parameter)	136
Switch-off value (parameter)	135
Switch-on delay (parameter)	135
Switch-on value (parameter)	134
Symbols	58, 61

T

Table mode (parameter)	121
Table number (parameter)	122
Terminal voltage 1 (parameter)	155
Text and numeric editor	61
Threaded connection	26, 36
Timestamp (parameter)	149
Timestamp 1 to 5 (parameter)	151
Tools	34
Trouble shooting	72
Turning the display module	40
Turning the housing	40



U	
Unit after linearization (parameter)	118
V	
Value 1 to 4 display (parameter)	139
Value echo lost (parameter)	125
Value process variable (parameter)	161
W	
Workplace safety	12
Write access	52







PROCESS AUTOMATION – PROTECTING YOUR PROCESS



Worldwide Headquarters

Pepperl+Fuchs GmbH
68307 Mannheim · Germany
Tel. +49 621 776-0
E-mail: info@de.pepperl-fuchs.com

For the Pepperl+Fuchs representative
closest to you check www.pepperl-fuchs.com/contact

www.pepperl-fuchs.com

Subject to modifications
Copyright PEPPERL+FUCHS • Printed in Germany

BA01009O/98/EN/14.14

 **PEPPERL+FUCHS**
PROTECTING YOUR PROCESS

DOCT-3996
03/2015