

IUH-F192-V1-*

Read/Write Head for
IDENTControl

Manual



IDENTControl

Your automation, our passion.

PEPPERL+FUCHS

With regard to the supply of products, the current issue of the following document is applicable:
The General Terms of Delivery for Products and Services of the Electrical Industry, published
by the Central Association of the Electrical Industry (Zentralverband Elektrotechnik und Elek-
troindustrie (ZVEI) e.V.) in its most recent version as well as the supplementary clause:
"Expanded reservation of proprietorship"

Worldwide

Pepperl+Fuchs Group
Lilienthalstr. 200
68307 Mannheim
Germany
Phone: +49 621 776 - 0
E-mail: info@de.pepperl-fuchs.com

North American Headquarters

Pepperl+Fuchs Inc.
1600 Enterprise Parkway
Twinsburg, Ohio 44087
USA
Phone: +1 330 425-3555
E-mail: sales@us.pepperl-fuchs.com

Asia Headquarters

Pepperl+Fuchs Pte. Ltd.
P+F Building
18 Ayer Rajah Crescent
Singapore 139942
Phone: +65 6779-9091
E-mail: sales@sg.pepperl-fuchs.com
<https://www.pepperl-fuchs.com>

1	Introduction.....	6
1.1	Content of this Document.....	6
1.2	Target Group, Personnel	6
1.3	Symbols Used	7
2	Certificates and approvals.....	8
2.1	Declaration of Conformity (RE Directive 2014/53/EU)	8
2.2	FCC-Information.....	8
2.3	IC-Information	9
2.4	UL Information	9
2.5	Additional country-specific approvals	9
3	Product Description	10
3.1	RFID Frequency Bands	10
3.2	UHF general.....	10
3.2.1	Advantages of UHF	10
3.2.2	Applications for UHF systems.....	10
3.2.3	Tag Memory Structure	11
3.2.4	Elektronic Product Code EPC.....	12
3.2.5	Influence of various materials on the sensing range	13
3.2.6	Dense Reader Mode (DRM)	13
3.2.7	Frequency Hopping Spread Spectrum	14
3.2.7.1	China	14
3.2.7.2	USA	14
3.2.8	Relevant Standards for UHF	15
3.3	Countries of Use	15
3.3.1	European Union.....	16
3.3.2	Argentina	16
3.3.3	Australia.....	16
3.3.4	Brazil	16
3.3.5	Canada.....	16
3.3.6	China	17
3.3.7	Hong Kong.....	17
3.3.8	India.....	17
3.3.9	Japan.....	17
3.3.10	Colombia	17
3.3.11	Malaysia	18
3.3.12	Morocco	18
3.3.13	Mexico	18
3.3.14	New Zealand	18
3.3.15	Singapore	19
3.3.16	South Korea.....	19
3.3.17	Thailand.....	19
3.3.18	United States of America	20
3.4	General Functions and Features	20

3.5	Indicators and Operating Elements	21
3.6	Connection	21
3.7	Scope of Delivery	22
3.8	Accessories	23
3.8.1	IDENTControl.....	23
3.8.2	Read/Write Tags.....	24
3.8.3	Connection Cable for Read/Write Devices and Trigger Sensors	24
3.8.4	Cable connectors for the power supply	25
3.8.5	Installation accessories.....	25
4	Installation	26
4.1	Storage and Transportation	26
4.2	Unpacking.....	26
4.3	Mounting	26
4.3.1	Room Orientation.....	28
4.3.2	Minimum Distances	29
4.3.3	Polarization	29
4.4	Connection	30
4.5	EMC Concept.....	30
5	Commissioning	31
5.1	Definitions.....	31
5.1.1	Display	31
5.1.2	Legend.....	31
5.2	Initial Commissioning.....	32
5.3	Sensor Settings.....	34
5.4	Operation via the Command Interface.....	34
6	Operation	37
6.1	General.....	37
6.2	Interference Due to Multipath Propagation	37
6.3	Command Overview	38
6.4	Read/Write Commands.....	39
6.5	Filter Commands.....	43
6.6	Configuration Commands.....	46
6.6.1	ChangeTag Command.....	47
6.6.2	Read and Write Parameters	48
6.6.3	Parameters	49
6.7	Error/Status Messages.....	60

7	Service and Maintenance	61
8	Troubleshooting.....	62
9	Appendix	63
9.1	Dimensions.....	63
9.2	ASCII table.....	63
9.3	Detection Range	64

1 Introduction

1.1 Content of this Document

This document contains information required to use the product in the relevant phases of the product life cycle. This may include information on the following:

- Product identification
- Delivery, transport, and storage
- Mounting and installation
- Commissioning and operation
- Maintenance and repair
- Troubleshooting
- Dismounting
- Disposal



Note

For full information on the product, refer to the further documentation on the Internet at www.pepperl-fuchs.com.



Note

For specific device information such as the year of construction, scan the QR code on the device. As an alternative, enter the serial number in the serial number search at www.pepperl-fuchs.com.

The documentation comprises the following parts:

- This document
- Datasheet

In addition, the documentation may comprise the following parts, if applicable:

- EU-type examination certificate
- EU declaration of conformity
- Attestation of conformity
- Certificates
- Control drawings
- Instruction manual
- Functional safety manual
- Other documents

1.2 Target Group, Personnel

Responsibility for planning, assembly, commissioning, operation, maintenance, and dismantling lies with the plant operator.

Only appropriately trained and qualified personnel may carry out mounting, installation, commissioning, operation, maintenance, and dismantling of the product. The personnel must have read and understood the instruction manual and the further documentation.

Prior to using the product make yourself familiar with it. Read the document carefully.

1.3 Symbols Used

This document contains symbols for the identification of warning messages and of informative messages.

Warning Messages

You will find warning messages, whenever dangers may arise from your actions. It is mandatory that you observe these warning messages for your personal safety and in order to avoid property damage.

Depending on the risk level, the warning messages are displayed in descending order as follows:



Danger!

This symbol indicates an imminent danger.

Non-observance will result in personal injury or death.



Warning!

This symbol indicates a possible fault or danger.

Non-observance may cause personal injury or serious property damage.



Caution!

This symbol indicates a possible fault.

Non-observance could interrupt the device and any connected systems and plants, or result in their complete failure.

Informative Symbols



Note

This symbol brings important information to your attention.



Action

1. This symbol indicates a paragraph with instructions. You are prompted to perform an action or a sequence of actions.

2 Certificates and approvals

2.1 Declaration of Conformity (RE Directive 2014/53/EU)

This product was developed and manufactured under observance of the applicable European standards and guidelines.



Note

A Declaration of Conformity can be requested from the manufacturer or downloaded from www.pepperl-fuchs.com.

The product manufacturer, Pepperl+Fuchs SE, 68307 Mannheim, has a certified quality assurance system that conforms to ISO 9001.



2.2 FCC-Information

This device complies with Part 15 of the FCC Rules. Operation is subject to the following two conditions:

1. this device may not cause harmful interference, and
2. this device must accept any interference received, including interference that may cause undesired operation.

Attention:

Changes or modifications not expressly approved by the party responsible for compliance could void the user's authority to operate the equipment.

Note:

This equipment has been tested and found to comply with the limits for a Class A digital device, pursuant to part 15 of the FCC Rules. These limits are designed to provide reasonable protection against harmful interference when the equipment is operated in a commercial environment. This equipment generates, uses, and can radiate radio frequency energy and, if not installed and used in accordance with the instruction manual, may cause harmful interference to radio communications. Operation of this equipment in a residential area is likely to cause harmful interference in which case the user will be required to correct the interference at his own expense.

FCC Notice

To comply with FCC part 15 rules in the United States, the system must be professionally installed to ensure compliance with the Part 15 certification. It is the responsibility of the operator and professional installer to ensure that only certified systems are deployed in the United States. The use of the system in any other combination (such as co-located antennas transmitting the same information) is expressly forbidden.

FCC Exposure Information

To comply with FCC RF exposure compliance requirements, the antennas used for this transmitter must be installed to provide a separation distance of at least 35 cm from all persons and must not be co-located or operated in conjunction with any other antenna or transmitter.

2.3 IC-Information

This device complies with Industry Canada licence-exempt RSS standard(s) and with part 15 of the FCC Rules. Operation is subject to the following two conditions:

1. this device may not cause interference, and
2. this device must accept any interference, including interference that may cause undesired operation of the device.

Le présent appareil est conforme aux CNR d'Industrie Canada applicables aux appareils radio exempts de licence. L'exploitation est autorisée aux deux conditions suivantes :

1. l'appareil ne doit pas produire de brouillage, et
2. l'utilisateur de l'appareil doit accepter tout brouillage radioélectrique subi, même si le brouillage est susceptible d'en compromettre le fonctionnement.

IC Exposure Information

To comply with IC RF exposure compliance requirements, the antennas used for this transmitter must be installed to provide a separation distance of at least 35 cm from all persons and must not be co-located or operated in conjunction with any other antenna or transmitter.

2.4 UL Information

Technical Data and Environmental Conditions

This device is for indoor use only.

This device may be operated in altitudes up to 2000 m.

The ambient temperature range is from -20 °C to +70 °C for operation with non-transmission periods, or -20 °C to +60 °C for continuous transmission mode. The pollution degree is 2.

The maximum relative humidity is 80 % for temperatures up to 31 °C, decreasing linearly to 50 % relative humidity at 40 °C.

Nominal power supply voltage is 24 V_{DC}, voltage range is 20 ... 30 V_{DC}. Supply must be PELV (Protective Extra Low Voltage). The overvoltage category II is applied. This is the case if Pepperl+Fuchs IDENTControl control interface is used.

Protection class IP67 is not included in the UL approval. The protection class is tested by Pepperl+Fuchs AG.

The external circuits intended to be connected to this unit must be galvanically isolated from the mains supply or hazardous live voltage by reinforced or double insulation and fall within the limits specified in clauses 6.3 and 9.4 of UL 61010-1.

2.5 Additional country-specific approvals

For all current approvals see the data sheet of your read / write head under www.pepperl-fuchs.com.

3 Product Description

3.1 RFID Frequency Bands

The following diagram shows the different frequency bands used for RFID. The devices described in this manual operate in the frequency range from 865 MHz ... 868 MHz, and from 902 MHz ... 928 MHz, which is highlighted.

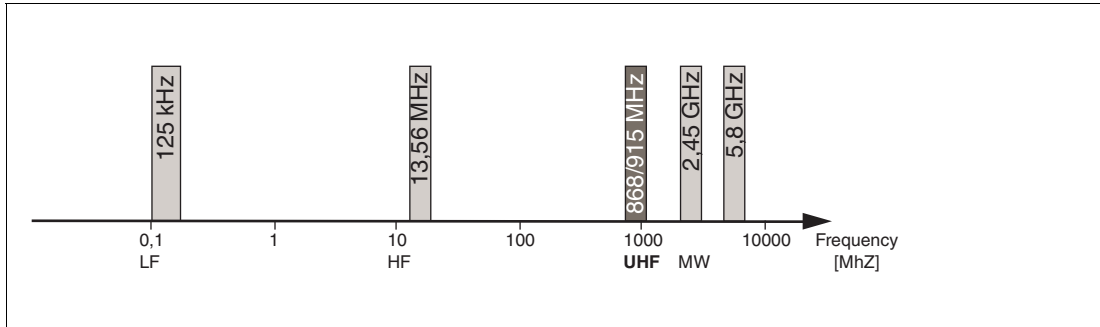

- 100 kHz ... 135 kHz: low frequency LF
- 13.56 MHz: high frequency HF
- 865 MHz ... 868 MHz (Europe), 902 MHz ... 928 MHz (USA), 920 MHz ... 925 MHz (China): ultra-high frequency UHF
- 2.45 GHz and 5.8 GHz: microwave MW

3.2 UHF general

3.2.1 Advantages of UHF

- Long detection range
- UHF tags are available as cheap and space-saving adhesive labels
- High transfer rates
- Tag is available with a large working memory (user memory)
- Bulk detection

3.2.2 Applications for UHF systems

- Identification in galvanic coating or painting systems used in automotive production,
- Identification feasible over greater distances than with LF and HF systems,
- Identification of automotive superstructures in automotive production,
- Pallet identification and measurement of goods movements in the logistics sector, and
- Access control at unloading stations with HGV identification.

3.2.3 Tag Memory Structure

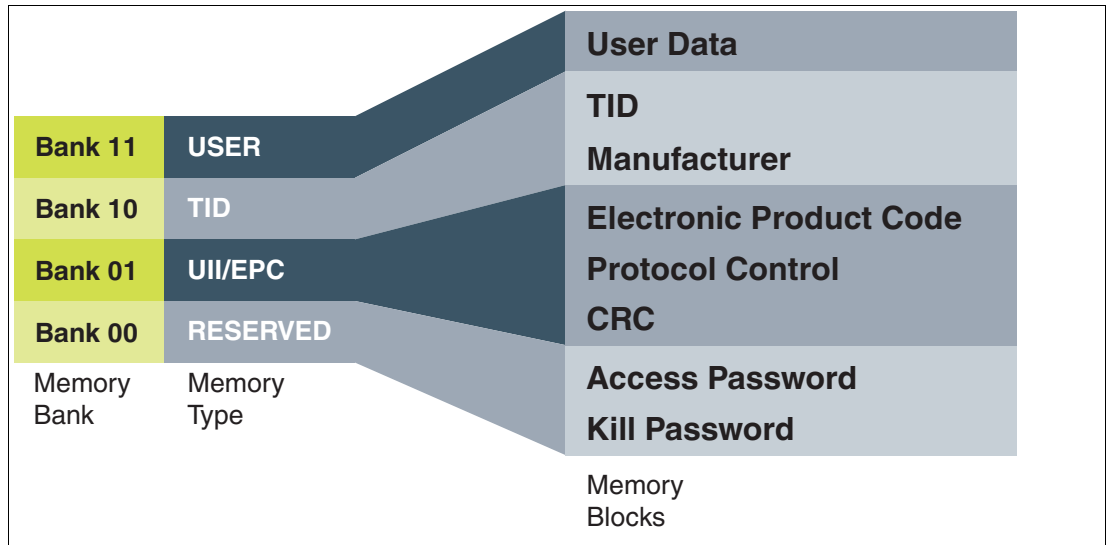

The memory of an EPC Gen2 (ISO/IEC 18000-63) tag is split into four memory banks. The main contents of these memory banks are:

Memory bank	Storage type	Memory blocks
Bank 00 (00 _{bin} = 0 _{dec})	RESERVED	Password management
Bank 01 (01 _{bin} = 1 _{dec})	UII/EPC	Unique Item Identifier (UII) Electronic Product Code (EPC)
Bank 10 (10 _{bin} = 2 _{dec})	TID	Tag ID (TID)
Bank 11 (11 _{bin} = 3 _{dec})	USER	User memory

Bank 00: RESERVED

Bank 00 contains the password management information. It comprises the access password and the kill password. This area is available depending on the chip type.

Bank 01: UII/EPC

In addition to the Unique Item Identifier (UII), **Bank 01** contains a calculated checksum CRC (Cyclic Redundancy Check) for verifying data on the tag and the protocol control (PC) area. The PC area contains:

- The length of the UII
- The Application Family Identifier (AFI) field
- A bit switch for an EPC sequence of numbers in accordance with ISO in Bank 01
- A bit switch for data stored in Bank 11, if available

Bank 10: TID

Bank 10 contains the tag identifier (TID), consisting of the part number and optional serial number of the tag. This data is permanently stored without being changed. The first byte denotes the class of the tag with E0_{hex}, E2_{hex}, or E3_{hex}. The rest of the TID depends on the class, and can be derived from standard ISO/IEC 18000-63.

For example:

All tags with the class EPC Gen2 (ISO/IEC 18000-63) are marked with $E2_{\text{hex}}$. The TID is comprised as follows:

- 4 bytes: Tag part number
 - 1 byte: Marking
 - 12 bits: Tag Mask Designer Identifier (MDID)
 - 12 bits: Tag model number (TMN), defined by the manufacturer
- 4 or 8 bytes: Tag serial number
Depending on the manufacturer, the serial numbers do not have to be unique or may even be omitted.

Bank 11: User memory

Bank 11 contains a memory that the user can freely access. The size of this memory depends on the chip type, or this memory may not be present.

3.2.4 Elektronische Product Code EPC

The electronic product code EPC is a unique identifier in the form of a sequence of numbers. The number sequence has a set structure and a length of 64 bits, 80 bits, 96 bits, or longer, depending on the EPC used. This number sequence is saved to the RFID tag, offering worldwide unique identification of the tagged object.

The EPC was defined by GS1 for use in inventory management. Tags with memory banks for EPC codes must be programmed by the user. The memory of new tags must not contain any valid EPC codes. The EPC numbers are managed and assigned by GS1. To obtain EPC numbers, please contact the GS1 branch in your country (www.gs1.com/contact).

The EPC is defined by GS1 with at present 13 different encoding schemes. SGTIN-96 (serialized global trade item number) is given here as an example of a frequently used encoding scheme. SGTIN-96 has a defined format, and is structured as follows:

1. **Header:** The header specifies the EPC standard used, and denotes the number sequence.
2. **Filter value:** Denotes the unit of the product, for example, end product, additional packaging, pallet.
3. **Partition:** Denotes the point at which the following company prefix ends and the object data begins.
4. **Company Prefix:** Assigned sequence of numbers that identifies the producer.
5. **Object class:** Sequence of numbers that describes the object, e.g., item number.
The company prefix and the object class are each of variable length, but together are always 44 bits long.
6. **Serial number:** Sequence of numbers that identifies the item, e.g., the sequential serial number of the item.

	Header	Filter value	Partition	Company Prefix	Objekt class	Serial number
Length [Bit]	8	3	3	20 ... 40	4 ... 24	38
Value	48_{dez}	0_{dez}	5_{dez}	4050143_{dez}	124_{dez}	203886_{dez}

Table 3.1

3.2.5 Influence of various materials on the sensing range

In the UHF range, the nature of the surrounding area and the surface to which the transponder is secured have a serious influence on the range that the system can attain. The UHF transponder cannot be mounted on metal without requiring adaptations. Glass has a negative influence on the sensing range when used as a mounting surface. If a UHF transponder is mounted on damp material, the sensing range is much poorer than the range of a transponder mounted on dry material. The mounting surface often affects the read range much more than the material between the transponder and the read/write device. The graph shows the effect of different materials on the sensing range.

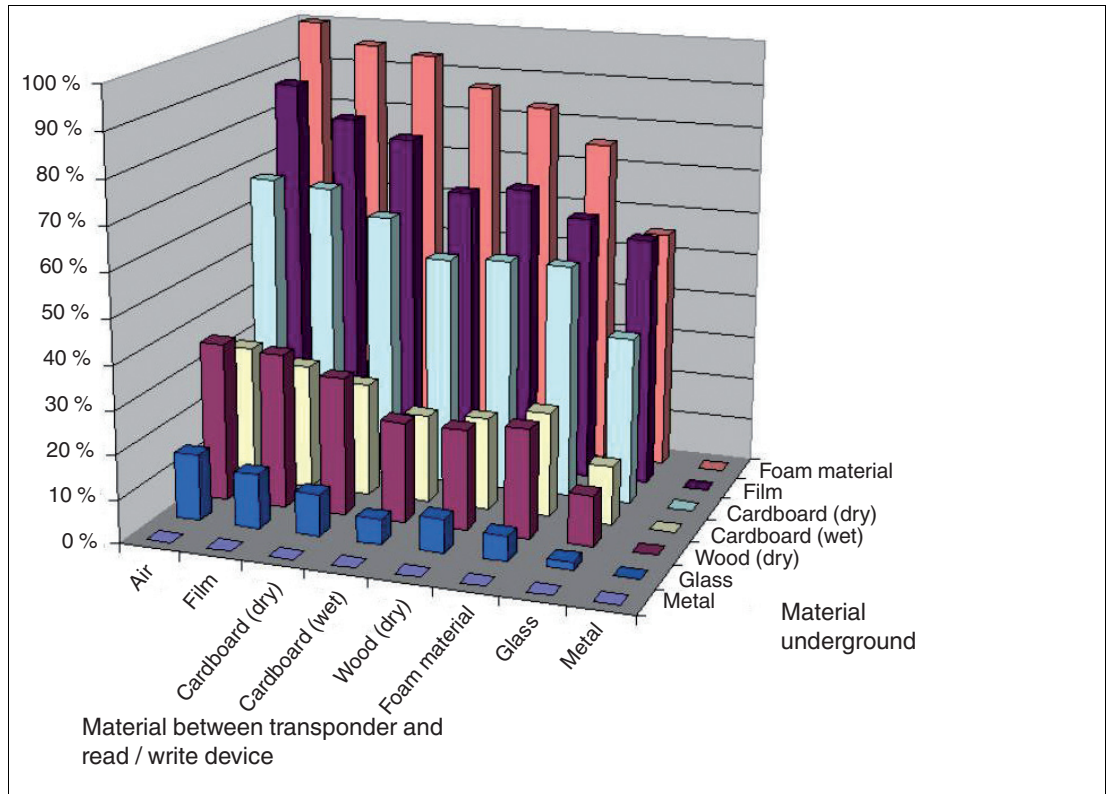

Figure 3.1

3.2.6 Dense Reader Mode (DRM)

Europe

A special operating mode for read/write tags in accordance with the specification EPC Gen 2 (ISO/IEC 18000-63) allows several read/write devices to be operated close to each other simultaneously without interference.

In accordance with EN 302208, the read/write device uses only channels 4, 7, 10, and 13 in this mode for transmission (read/write head → read/write tag communication path). The transmission power is a maximum of 2 W_{erp} in accordance with EN 302208.

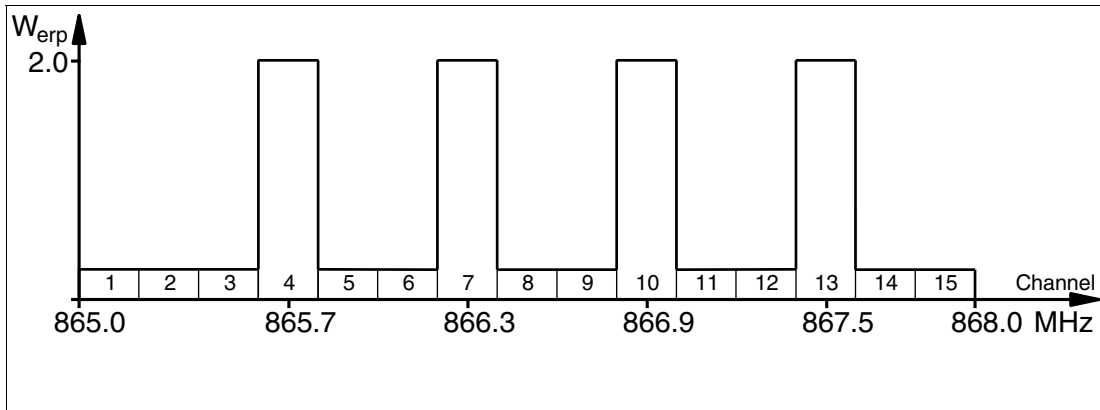

Figure 3.2

The response from the read/write tag appears via the frequency offset, which is achieved by the modulation used in this mode on the two adjacent channels. Due to the high level difference between the transmission channels and the response channels, this technology offers major benefits for reusing frequencies.

3.2.7 Frequency Hopping Spread Spectrum

With FHSS (Frequency Hopping Spread Spectrum), the information to be transmitted is distributed successively through multiple channels. Only one frequency channel is used at any one time. This results in a larger bandwidth for the entire signal, in spite of the fact that each channel has a smaller bandwidth. In this section the channel assignment for China and the USA is shown graphically. For both assignments, different parameters apply, such as channel number and channel bandwidth. Different parameterizations apply in other countries.

3.2.7.1 China

In China, the frequency range 920 MHz ... 925 MHz is available for UHF-RFID read/write devices. The range is split into channels, each with a bandwidth of 250 kHz. A maximum of 2 W_{erp} is permitted on 16 of the available channels. The transmission power is indicated in W_{erp} . FHSS is used with a maximum retention time of two seconds. The UHF RFID read/write device for China uses channel 2 to 17.

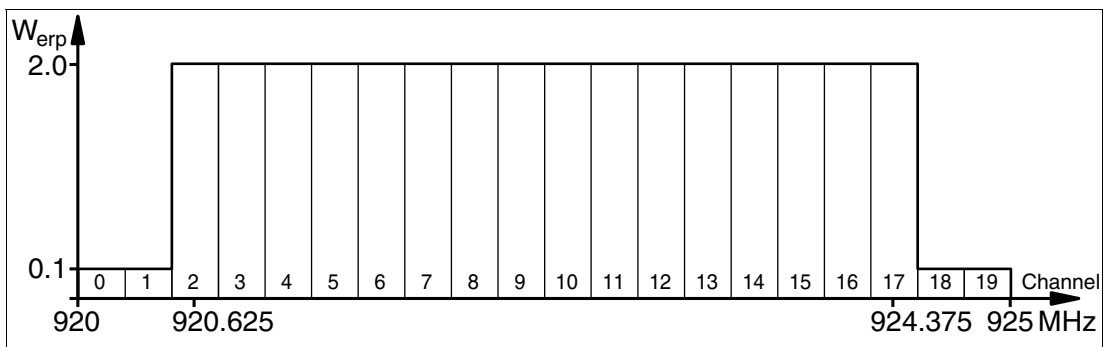

Figure 3.3

3.2.7.2 USA

The ISM band from 902 MHz ... 928 MHz is available in the USA. The band is split into 50 channels, each with a 500 kHz bandwidth. FHSS with a maximum retention time of 0.4 seconds is used. All channels must be used. Channel restriction is not permitted.

In contrast to the read/write devices for Europe and China, the transmission power is indicated in W_{eirp} . A maximum of 4 W_{eirp} is permitted on all channels.

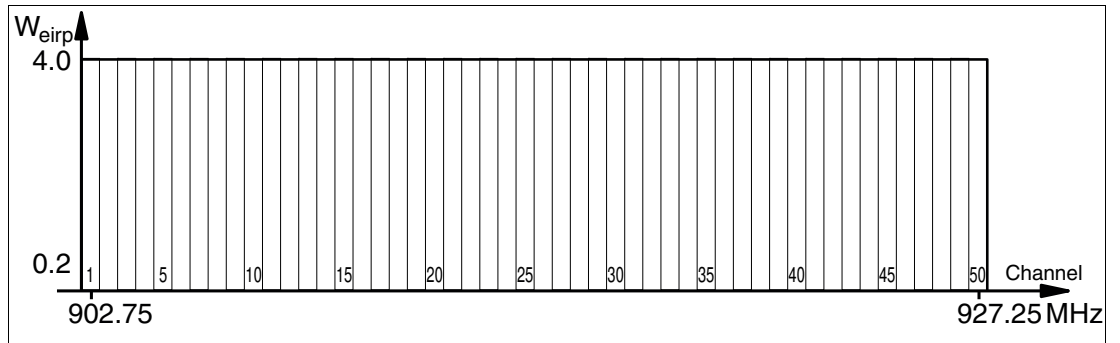

Figure 3.4

3.2.8 Relevant Standards for UHF

European radio standards: EN 300220 and EN 302208

Usage recommendations for RFID type labels, information about recycling, installation of readers and antennae: ISO/IEC TR 24729 parts 1-4

Installation and commissioning of UHF-RFID systems: ETSI TR 102436

Description of air interface: EPC Gen 2 (ISO/IEC 18000-63)

3.3 Countries of Use



Note

Country Identifier

All IUH-F192-V1-* read/write heads operate within their maximum frequency range with the appropriate settings for the relevant country. You must set the correct country identifier when commissioning for the first time. See chapter 5.2.



Note

If you wish to use the IUH-F192-V1-* read/write head in a country not included in this chapter, make sure the relevant values for the read/write head are consistent with the local conditions before use.



Note

Transmission License

A country-specific transmission license is required to operate the read/write head. In the European Union and Turkey, the manufacturer's EU declaration of conformity constitutes an adequate license. A currently valid transmission license may not exist for all countries of use listed in this chapter, as transmission licenses are temporary in some countries. All currently valid transmission licenses can be found in the data sheet for the respective read/write head at www.pepperl-fuchs.com

The country identifier also defines the frequency access method used.

Frequency Access Method

- In many countries, including the USA and China, a frequency hopping spread spectrum is used. See chapter 3.2.7. The number and position of the frequencies is fixed and cannot be changed by the user. All channels are used.
- A programmable frequency list is used in other countries, including the European Union, Singapore and India. You can compile this frequency list from a specified set of channels. Four channels are specified in the European Union as appropriate for dense reader mode in accordance with EN 302208. See chapter 3.2.6. When selecting this country identifier, you can configure one or more channels, or all four channels.

3.3.1 European Union

In the European Union, the use of RFID in the UHF range is regulated by EN 302208.

- UHF frequency range: 865 MHz ... 868 MHz
- Radiated power: 10 mW ... 2000 mW_{ERP}; Default = 500 mW_{ERP} (IUH-F192-V1-FR1)
- Channel bandwidth: 200 kHz
- Channel spacing: 600 kHz
- Frequency access method: programmable frequency list
- Number of predefined channels: 4
 Programmable channels: 4, 7, 10, 13
 Center frequencies: 865.7 MHz, 866.3 MHz, 866.9 MHz, 867.5 MHz
 Up to four channels can be parameterized and used in sequence.
 Default: dense reader mode on channel 4, 10, 7, 13. See chapter 3.2.6.

3.3.2 Argentina

The regulations for the UHF frequency range in Argentina are the same as the regulations for the UHF frequency range in the USA. See chapter 3.3.18.

3.3.3 Australia

In Australia, the use of RFID in the UHF range is regulated as follows:

- UHF frequency range: 920 MHz ... 926 MHz
- Radiated power: 10 mW ... 4000 mW_{EIRP}; Default = 800 mW_{EIRP} (IUH-F192-V1-FR2)
- Channel bandwidth: 500 kHz
- Channel spacing: 500 kHz
- Frequency access method: frequency hopping spread spectrum. See chapter 3.2.7.
- Number of channels: 12
 Channels used: 1, 2, 3, ... 12
 Center frequencies: 919.75 MHz + (M x 0.5) MHz
 All 12 channels are always used.

3.3.4 Brazil

In Brazil, the use of RFID in the UHF range is regulated as follows:

- UHF frequency range: 915 MHz ... 928 MHz
- Radiated power: 10 mW ... 4000 mW_{EIRP}; Default = 800 mW_{EIRP} (IUH-F192-V1-FR2)
- Channel bandwidth: 250 kHz
- Channel spacing: 250 kHz
- Frequency access method: frequency hopping spread spectrum. See chapter 3.2.7.
- Number of channels: 52
 Channels used: 1, 2, 3, ... 52
 Center frequencies: 914.875 MHz + (M x 0.25) MHz
 All 52 channels are always used.

3.3.5 Canada

The regulations for the UHF frequency range in Canada are the same as the regulations for the UHF frequency range in the USA. See chapter 3.3.18.

3.3.6 China

In China, the use of RFID in the UHF range is regulated by the provisions of the China Ministry of Industry and Information Technology (CMIIT).

- UHF frequency range: 920 MHz ... 925 MHz
- Radiated power: 6 mW ... 2000 mW_{ERP}; Default = 500 mW_{ERP} (IUH-F192-V1-FR2)
- Channel bandwidth: 250 kHz
- Channel spacing: 250 kHz
- Frequency access method: frequency hopping spread spectrum (China). See chapter 3.2.7.
- Number of channels: 16
Channels used: 2, 3, 4, ... 17
Center frequencies: 920.125 MHz + (M x 0.25) MHz
All 16 channels are always used.

3.3.7 Hong Kong

The regulations for the UHF frequency range of 865 MHz to 868 MHz in Hong Kong are the same as the regulations for the UHF frequency range in the European Union. See chapter 3.3.1.

The regulations for the UHF frequency range of 920 MHz to 925 MHz in Hong Kong are the same as the regulations for the UHF frequency range in Thailand. See chapter 3.3.17.

3.3.8 India

In India, the use of RFID in the UHF range is regulated in accordance with EN 302208.

- UHF frequency range: 865 MHz ... 867 MHz
- Radiated power: 10 mW ... 2000 mW_{ERP}; Default = 500 mW_{ERP} (IUH-F192-V1-FR1)
- Channel bandwidth: 200 kHz
- Channel spacing: 200 kHz
- Frequency access method: programmable frequency list
- Number of predefined channels: 10
Programmable channels: 1, 2, 3, ... 10
Center frequencies: 865.1 MHz, 865.3 MHz, 865.5 MHz, 865.7 MHz, 865.9 MHz, 866.1 MHz, 866.3 MHz, 866.5 MHz, 866.7 MHz, 866.9 MHz
Up to ten channels can be parameterized and used in sequence.
Default: dense reader mode on channel 1, 7, 4, 10. See chapter 3.2.6.

3.3.9 Japan

In Japan, the use of RFID in the UHF range is regulated as follows:

- UHF frequency range: 916.7 MHz ... 920.5 MHz
- Radiated power: 10 mW ... 4000 mW_{EIRP}; Default = 800 mW_{EIRP} (IUH-F192-V1-FR2)
- Channel bandwidth: 200 kHz
- Channel spacing: 1200 kHz
- Frequency access method: programmable frequency list.
- Number of predefined channels: 4
Programmable channels: 5, 11, 17, 23
Center frequencies: 916.8 MHz, 918.0 MHz, 919.2 MHz, 920.4 MHz
Up to four channels can be parameterized and used in sequence.
Default: dense reader mode on channel 5, 17, 11, 23. See chapter 3.2.6.

3.3.10 Colombia

The regulations for the UHF frequency range in Colombia are the same as the regulations for the UHF frequency range in Brazil. See chapter 3.3.4.

3.3.11 Malaysia

In Malaysia, the use of RFID in the UHF range is regulated as follows:

- UHF frequency range: 919 MHz ... 923 MHz
- Radiated power: 6 mW ... 2000 mW_{ERP}; Default = 500 mW_{ERP} (IUH-F192-V1-FR2)
- Channel bandwidth: 500 kHz
- Channel spacing: 500 kHz
- Frequency access method: frequency hopping spread spectrum. See chapter 3.2.7.
- Number of channels: 8
Channels used: 1, 2, 3, ... 8
Center frequencies: 918.75 MHz + (M x 0.5) MHz
All 8 channels are always used.

3.3.12 Morocco

In Morocco, the use of RFID in the UHF range is regulated in accordance with EN 302208:

- UHF frequency range: 867.6 ... 868.0 MHz
- Radiated Power: 3 ... 500 mW_{erp}; Default = 50 mW_{erp}
- Channel bandwidth: 200 kHz
- Channel spacing: 200 kHz
- Frequency access method: programmable frequency list.
- Number of predefined channels: 1
Programmable channels: 1, 2
Center frequencies: 867.7 MHz, 867.9 MHz
Up to two channels can be parameterized simultaneously and used in sequence.
Default: dense reader mode on channel 1, 2. See chapter 3.2.6.

3.3.13 Mexico

The regulations for the UHF frequency range in Mexico are the same as the regulations for the UHF frequency range in the USA. See chapter 3.3.18.

3.3.14 New Zealand

In New Zealand, the use of RFID in the UHF range is regulated as follows:

- UHF frequency range: 921.5 MHz ... 928 MHz
- Radiated power: 10 mW ... 4000 mW_{EIRP}; Default = 800 mW_{EIRP} (IUH-F192-V1-FR2)
- Channel bandwidth: 500 kHz
- Channel spacing: 500 kHz
- Frequency access method: frequency hopping spread spectrum. See chapter 3.2.7.
- Number of channels: 13
Channels used: 1, 2, 3, ... 13
Center frequencies: 921.25 MHz + (M x 0.5) MHz
All 13 channels are always used.

3.3.15 Singapore

In Singapore, the use of RFID in the UHF range of 866 MHz to 868 MHz is regulated in accordance with EN 302208.

- UHF frequency range: 866 MHz ... 868 MHz
- Radiated power: 10 mW ... 500 mW_{ERP}; Default = 500 mW_{ERP} (IUH-F192-V1-FR1)
- Channel bandwidth: 200 kHz
- Channel spacing: 200 kHz
- Frequency access method: programmable frequency list
- Number of predefined channels: 10
 Programmable channels: 1, 2, 3, ... 10
 Center frequencies: 866.1 MHz, 866.3 MHz, 866.5 MHz, 866.7 MHz, 866.9 MHz, 867.1 MHz, 867.3 MHz, 867.5 MHz, 867.7 MHz, 867.9 MHz
 Up to ten channels can be parameterized and used in sequence.
 Default: dense reader mode on channel 1, 7, 4, 10. See chapter 3.2.6.

In Singapore, the use of RFID in the UHF range of 920 MHz to 925 MHz is regulated as follows.

- UHF wavelength: 920 MHz ... 925 MHz
- Radiated power: 6 mW ... 2000 mW_{ERP}; Default = 500 mW_{ERP} (IUH-F192-V1-FR2)
- Channel bandwidth: 500 kHz
- Channel spacing: 500 kHz
- Frequency access method: frequency hopping spread spectrum. See chapter 3.2.7.
- Number of channels: 10
 Channels used: 1, 2, 3, ... 10
 Center frequencies: 919.75 MHz + (M x 0.5) MHz
 All ten channels are always used.

3.3.16 South Korea

In South Korea, the use of RFID in the UHF range is regulated as follows:

- UHF frequency range: 917.2 MHz ... 920.4 MHz
- Radiated power: 10 mW ... 4000 mW_{EIRP}; Default = 800 mW_{EIRP} (IUH-F192-V1-FR2)
- Channel bandwidth: 200 kHz
- Channel spacing: 600 kHz
- Frequency access method: frequency hopping spread spectrum. See chapter 3.2.7.
- Number of channels: 6
 Channels used: 1, 4, 7, 10, 13, 16
 Center frequencies: 917.1 MHz + (M x 0.20) MHz
 All 6 channels are always used.

3.3.17 Thailand

In Thailand, the use of RFID in the UHF range is regulated as follows:

- UHF frequency range: 920 MHz ... 925 MHz
- Radiated power: 10 mW ... 4000 mW_{EIRP}; Default = 800 mW_{EIRP} (IUH-F192-V1-FR2)
- Channel bandwidth: 500 kHz
- Channel spacing: 500 kHz
- Frequency access method: frequency hopping spread spectrum. See chapter 3.2.7.
- Number of channels: 10
 Channels used: 1, 2, 3, ... 10
 Center frequencies: 919.75 MHz + (M x 0.5) MHz
 All ten channels are always used.

3.3.18 United States of America

In the USA, the use of RFID in the UHF range is regulated in accordance with the provisions set out by the Federal Communications Commission (FCC).

- UHF frequency range: 902 MHz ... 928 MHz
- Radiated power: 10 mW ... 4000 mW_{EIRP}; Default = 800 mW_{EIRP} (IUH-F192-V1-FR2-02)
- Channel bandwidth: 500 kHz
- Channel spacing: 500 kHz
- Frequency access method: frequency hopping spread spectrum (USA). See chapter 3.2.7.
- Number of channels: 50
Channels used: 1, 2, 3, ... 50
Center frequencies: 902.25 MHz + (M x 0.5) MHz
All 50 channels are always used.

3.4 General Functions and Features

IUH-F192-V1-FR*



Figure 3.5

Functions

The read/write head was developed for reading and writing passive read/write tags with an ultra-high operating frequency.

Detection Range

The detection range is typically 4 meters. Tags that comply with EPC Gen 2 (ISO/IEC 18000-63) are supported.

Maximum Frequency Range

The IUH-F192-V1-FR1 read/write head can be operated in the frequency range from 865 MHz to 868 MHz. The IUH-F192-V1-FR2 read/write head can be operated in the frequency range from 902 MHz to 928 MHz.

Features

The read/write head has the following features:

- 2 x 3 function indicator LEDs
- Industrial housing
- Bulk detection
- Connects to the IDENTControl via connector V1 (M12 x 1)
- Protected against electrostatic discharge

Integrated antenna

The IUH-F192-V1-FR1 and IUH-F192-V1-FR2 read/write heads have a linear dual-polarized antenna. The read/write heads can transmit and receive waves with horizontal and vertical polarization.

Electrical specifications

Operating voltage U	20 ... 30 V _{DC}
Current consumption I	< 350 mA
Power consumption P ₀	≤ 10 W

3.5 Indicators and Operating Elements

The IUH-F192-V1-* read/write head has 2 x 3 LEDs, which are green/blue/yellow. The various indicators denote:

- Green LED:
Continuously on - Power on
Flashing - Region code must be set. See chapter 5.2.
- Yellow LED: Read/write operation successful
- Blue LED: Transmission mode

3.6 Connection



Caution!

Cable specifications

The maximum permissible temperature of the connection cable must be at least +80 °C.

The minimum diameter of the connection cable must be 22 AWG or 0.34 mm².

IUH-F190-V1-*

The IUH-F190-V1-* read/write head is connected to the IDENTControl control interface via the M12 x 1 connector.

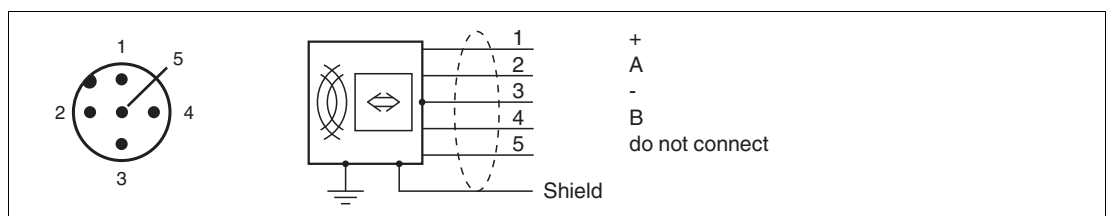

Figure 3.6

- | | |
|---|--|
| 1 | + < 30 V _{DC} , < 450 mA (20 ... 30 V _{DC}) |
| 2 | Data input/output A, RS-485, -7 V ... +12 V |
| 3 | 0 V |
| 4 | Data input/output B, RS-485, -7 V ... +12 V |
| 5 | Data output 0 ... 3.3 V _{DC} |

IUT-F190-R4-V1-*

The IUT-F190-R4-V1-* read/write head is connected to an RS-485 serial interface of the parent device via the M12 x 1 connector via a point-to-point connection. The read/write head has an internal terminator on the RS-485 interface. For this reason, only one read/write head is provided within an RS-485 network. It is not possible to build an RS-485 network with multiple read/write heads. The factory-set transfer rate of the interface is 38,400 bit/s.

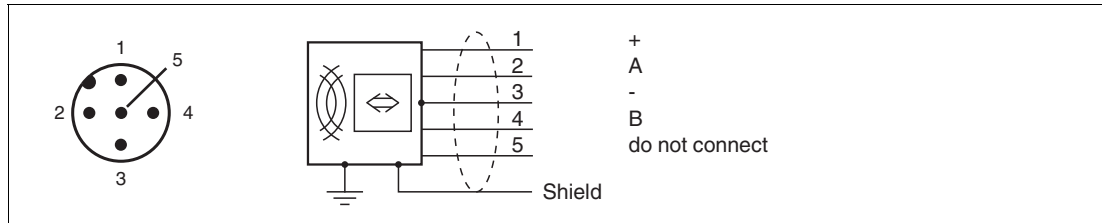



Figure 3.7

- | | |
|---|--|
| 1 | + < 30 V _{DC} , < 450 mA (20 ... 30 V _{DC}) |
| 2 | Data input/output A, RS-485, -7 V ... +12 V |
| 3 | 0 V |
| 4 | Data input/output B, RS-485, -7 V ... +12 V |
| 5 | Data output 0 ... 3.3 V _{DC} |

Ground connection

The ground connection of the read/write head is positioned on the right-hand side when viewed from the front, if the cable outlet is facing downward. The ground conductor is screwed to the housing with a crimp connector. In order to guarantee safe grounding, mount the serrated washer between the crimp connectors and the housing.

The screw connection, which is marked with the symbol  or  depending on the device type, is used to connect the functional earth.

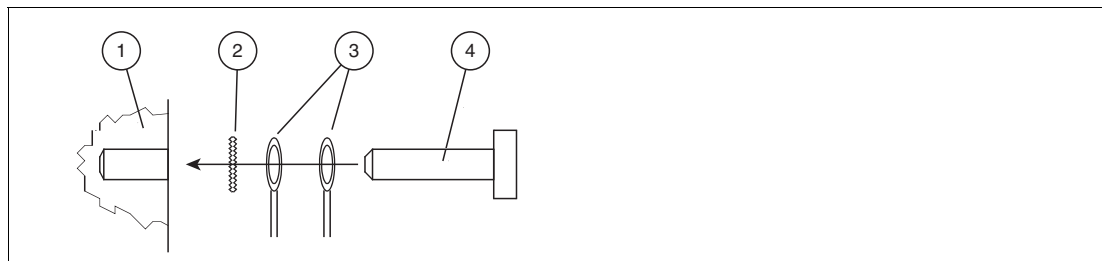

- | | |
|---|----------------------|
| 1 | Housing |
| 2 | Serrated lock washer |
| 3 | Crimp connector |
| 4 | Lock screw |

Use a ground conductor lead with a cross-section of at least 4 mm².
Tighten the retaining bolt to a tightening torque of 1.6 Nm ± 0.4 Nm.

3.7 Scope of Delivery

- Read/write head
- Quick start guide

3.8 Accessories

3.8.1 IDENTControl

The read/write device is connected to Pepperl+Fuchs IDENTControl control interfaces.



Figure 3.8



Figure 3.9

Interface	Designation
4 read/write devices:	
Ethernet	IC-KP-B17-AIDA1
2 read/write devices:	
PROFIBUS	IC-KP2-2HB6-V15B
Ethernet	IC-KP2-2HB17-2V1D
EtherCAT	IC-KP2-2HB21-2V1D
Serial	IC-KP2-2HRX-2V1
1 read/write device:	
PROFIBUS	IC-KP2-1HB6-V15B IC-KP2-1HB6-2V15B
Ethernet	IC-KP2-1HB17-2V1D
Serial	IC-KP2-1HRX-2V1

Table 3.2

3.8.2 Read/Write Tags

Type	Designation
EPC Gen 2 (ISO/IEC 18000-63)	IUC76-F157-T17-M-FR1 IUC76-F157-T17-M-FR2 IUC76-F157-T18-M-FR1 IUC76-F157-T18-M-FR2 IUC76-F157-T19-M-FR1 IUC76-F157-T19-M-FR2 IUC77-25L100-GBL 1000pcs IUC76-50-FR1 IUC76-50-FR2 IUC76-28L90-M-FR1 25pcs IUC76-28L90-M-FR2 25pcs IUC76-34-M-FR1 IUC76-34-M-FR2

Table 3.3

3.8.3 Connection Cable for Read/Write Devices and Trigger Sensors

Compatible connection cables with shielding are available to connect the read/write devices and trigger sensors.



Figure 3.10

Accessories	Description
2 m long (straight female, angled male)	V1-G-2M-PUR-ABG-V1-W
5 m long (straight female, angled male)	V1-G-5M-PUR-ABG-V1-W
10 m long (straight female, angled male)	V1-G-10M-PUR-ABG-V1-W
20 m long (straight female, angled male)	V1-G-20M-PUR-ABG-V1-W

2024-08

Accessories	Description
Field attachable female connector, straight, shielded	V1-G-ABG-PG9
Field attachable male connector, straight, shielded	V1S-G-ABG-PG9
Field attachable female connector, angled, shielded	V1-W-ABG-PG9
Field attachable male connector, angled, shielded	V1S-W-ABG-PG9
Dummy plug M12x1	VAZ-V1-B3

3.8.4 Cable connectors for the power supply

Compatible M12 sockets with an open cable end for connecting the IDENTControl to a power supply are available in different lengths.

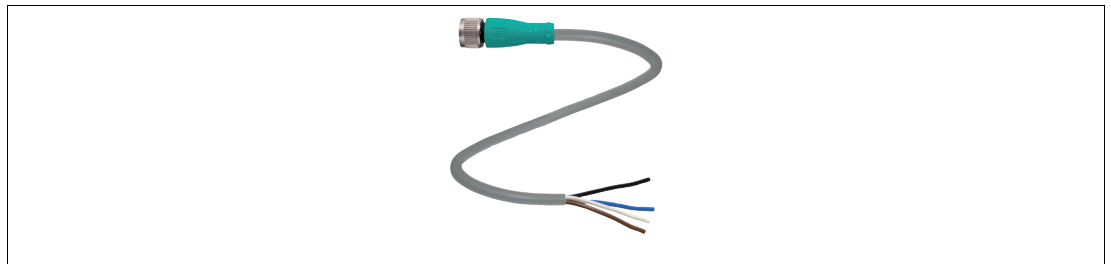

Figure 3.11

Accessories	Designation
Length 2 m (straight socket)	V1-G-2M-PUR
Length 5 m (straight socket)	V1-G-5M-PUR
Length 10 m (straight socket)	V1-G-10M-PUR

3.8.5 Installation accessories

Two different mounting brackets are available to mount the read/write head on a wall or pole.



Figure 3.12 IUZ-MH10

Accessories	Designation
Mounting bracket for wall attachment	IUZ-MH10
Mounting bracket for pipe installation (pipe with maximum diameter of 40 mm)	IUZ-MH11

4 Installation

4.1 Storage and Transportation

Keep the original packaging. Always store and transport the device in the original packaging. Store the device in a clean and dry environment. The permitted ambient conditions must be considered, see datasheet.

4.2 Unpacking

Check the product for damage while unpacking. In the event of damage to the product, inform the post office or parcel service and notify the supplier.

Check the package contents against your purchase order and the shipping documents for:

- Delivery quantity
- Device type and version in accordance with the type label
- Any accessories ordered

Retain the original packaging in case you have to store or ship the device again at a later date. Should you have any questions, please contact Pepperl+Fuchs.

4.3 Mounting



Warning!

Malfunctions with pacemakers

This device does **not** exceed the permissible limits for electromagnetic fields. Maintain a minimum distance of 25 cm between the device and your pacemaker.

Inadequate distance from the read/write head can result in inhibitions, reprogramming, or incorrect stimulation pulses.



Warning!

Hot surfaces

Caution, risk of burns when handling the device! Allow the device to cool for at least half an hour after it has been switched off before you touch it.

The read/write head is intended for wall mounting or mounting on brackets in internal areas. Please mount the read/write head using only the holes provided in the housing. The preferred mounting direction is with the cable connection facing vertically downwards.



Note

Do not lay the connection cable in the main beam direction of the antenna.

To attach the read/write head, use four screws with a diameter of 6 mm, as well as mounting materials that are suitable for the type of mounting surface. The tightening torque of the screws depends on the type of mounting.



Caution!

Mounting the read/write head

Make sure that the read/write head is firmly attached to the mounting surface.



Note

The installation recommendations made in this document are based on favorable conditions. Pepperl+Fuchs GmbH provides no guarantee of correct function in cross environments.

Mounting the read/write head

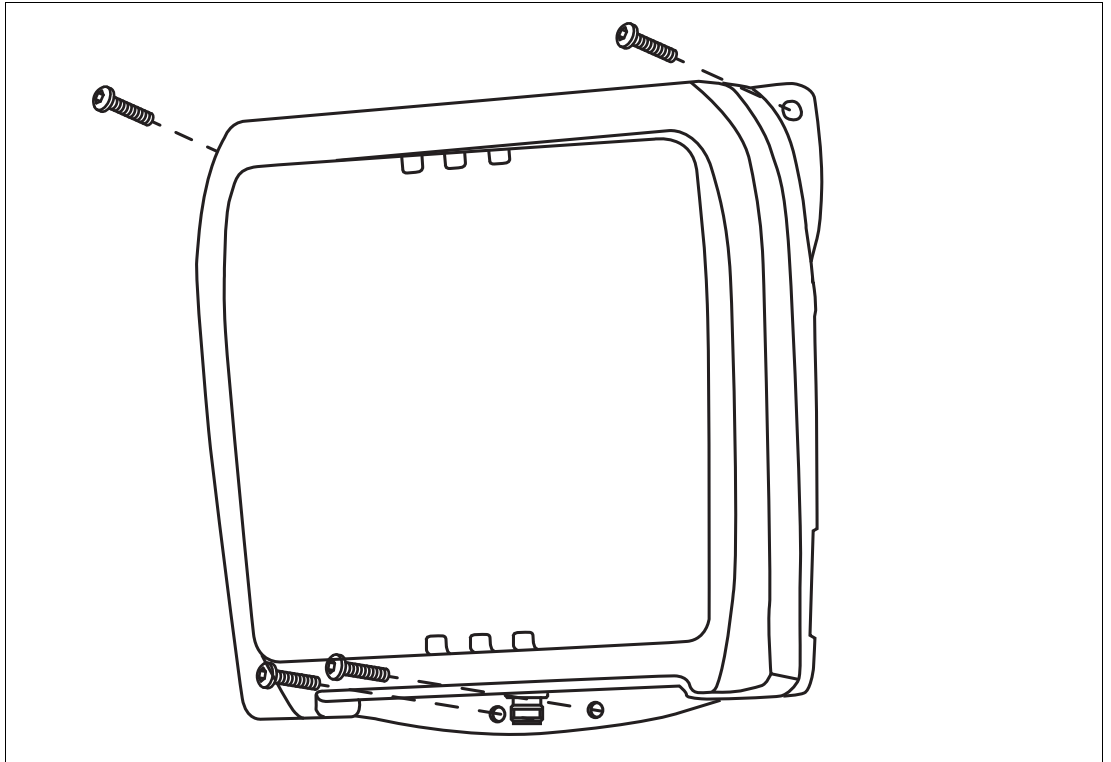
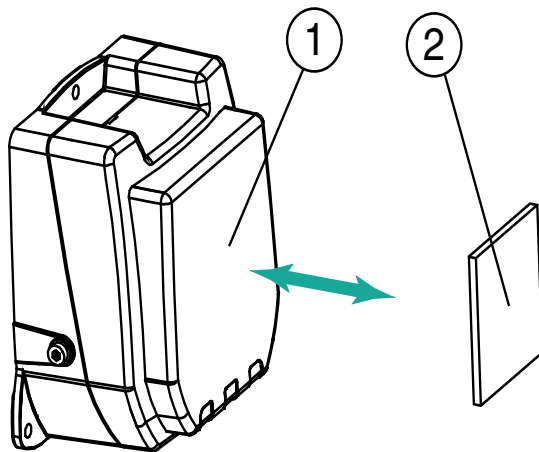

Figure 4.1

4.3.1 Room Orientation

The alignment of the read/write tag antennae in relation to the antennae of the read/write device influences the detection range of the system. Make sure the antennae are aligned parallel to each other.



Optimum alignment of the tag

- Good communication between the read/write device and tag

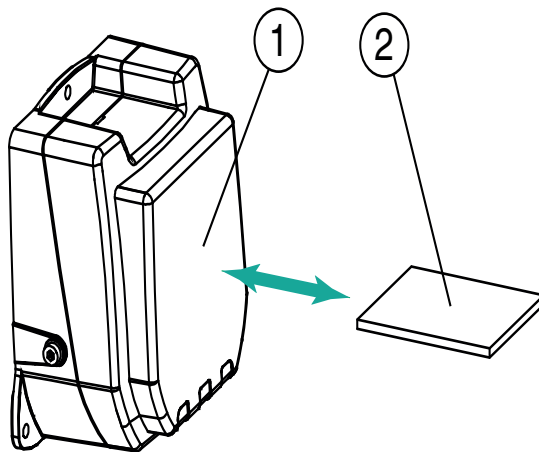

Poor alignment of the tag

- Insufficient communication between the read/write device and tag

- 1 Read/Write Device
2 Tag

4.3.2 Minimum Distances

When positioning the read/write device, please observe the minimum distances. The lateral distance between the read/write device and metals or liquids should be at least 50 cm. The distance between the read/write device and the ground should be at least 50 cm.

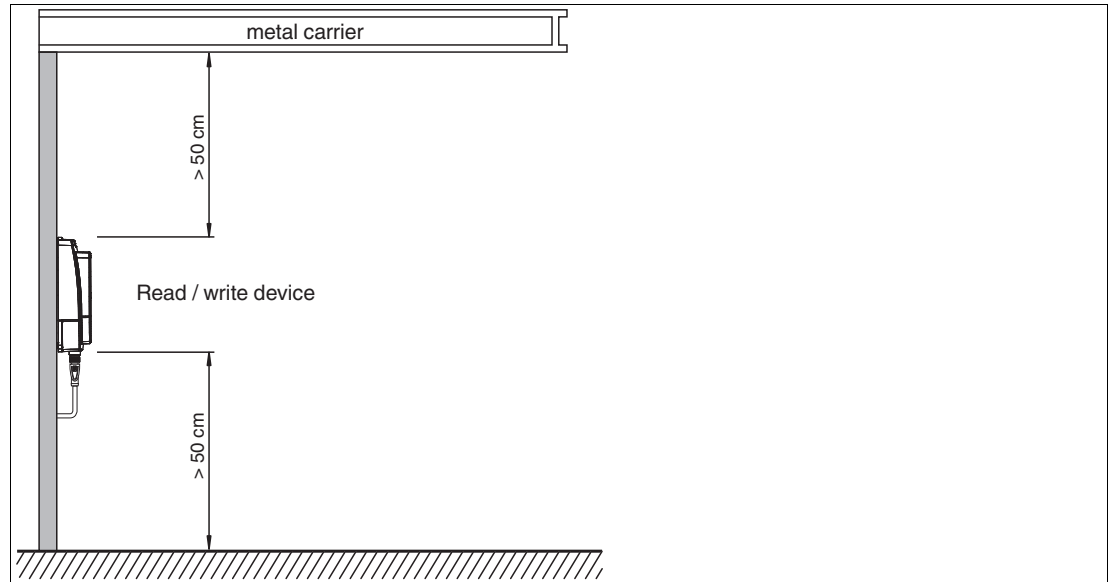

Figure 4.2

During simultaneous operation of several read/write devices, only one read/write device may ever communicate with a tag at any given time. When arranging the read/write devices, make sure that the measurement ranges do not overlap. You can enlarge or reduce the size of the measurement range by changing the transmitting power. Determine the measurement range of each read/write device at the mounting location.



Note

During mounting, take into account how the read/write devices may cause interference with each other. The further the transmission channels of the read/write devices are from each other, the lower the risk of interference.

4.3.3 Polarization

The polarization of the electromagnetic wave emitted by an antenna depends on the electromagnetic field component and the position of the antenna. Polarization can be either linear or circular. To achieve the maximum detection range for a UHF system, the polarization of the read/write head must match the polarization of the tag. Refer to the relevant data sheet to find the polarization of the tag.

- **Linear polarization:** When an electromagnetic wave has linear polarization, the direction of the vector of the electromagnetic field component is constant. Linear polarization can be either vertical or horizontal. This characteristic depends on the position of the antenna.
- **Circular polarization:** When an electromagnetic wave has circular polarization, the vector of the electromagnetic field component rotates around an axis parallel to the direction of emission. The rotation of the antenna around the transmission axis has no effect.

The integrated antenna of the IUH-F192-V1-* read/write head has dual linear polarization. The read/write head operates in combined mode by default. In combined mode, both horizontal and vertical polarization are used for each read/write access. This increases the reading reliability of tags with an unknown location in the room.

If the orientation of the tags is known, you can optimize the access time by setting a fixed polarization. To do this, you can switch the polarization to horizontally linear polarization or vertically linear polarization via the IDENTControl control interface software. The linear polarization plane refers to the preferred mounting direction with the cable connection mounted vertically downwards.

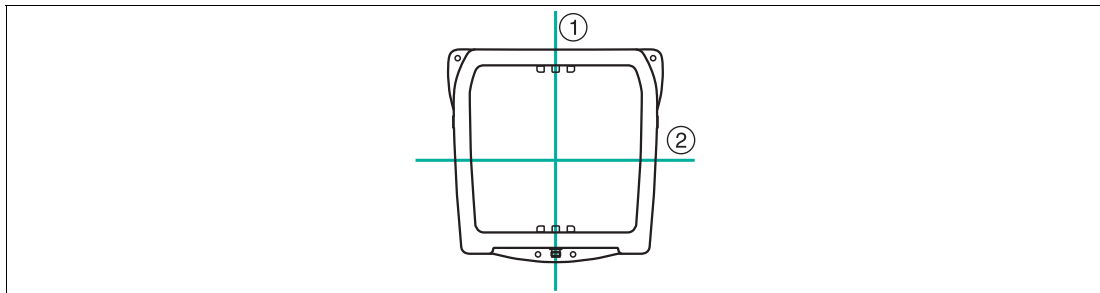

Figure 4.3 1 = Vertical polarization plane
2 = Horizontal polarization plane

4.4 Connection

Connect the IUH-F190-V1-* read/write head to the IDENTControl control interface using a shielded cordset (see chapter 3.8.3). Ensure that the shield fully encapsulates the connection cable to avoid EMC interference. (see chapter 4.5)

Connect the IUT-F190-R4-V1-* read/write head to the higher level control unit using a shielded cordset. Ensure that the shield is fully encapsulating so that interference is dissipated via the protective earth connections to avoid EMC disturbances.



Warning!

Incorrect electrical connection

Damage to the device or plant caused by incorrect electrical connection.

Check all connections in the plant before commissioning the device.

After connecting the supply voltage, the POWER LED on the device lights up green. If the LED does not light up on the device, the power supply is not connected correctly.

4.5 EMC Concept

The outstanding noise immunity of the IDENTControl against emission and immission is based on its consistent shielding design, which uses the principle of the Faraday cage. Interference is caught in the shield and safely diverted via the ground connections.

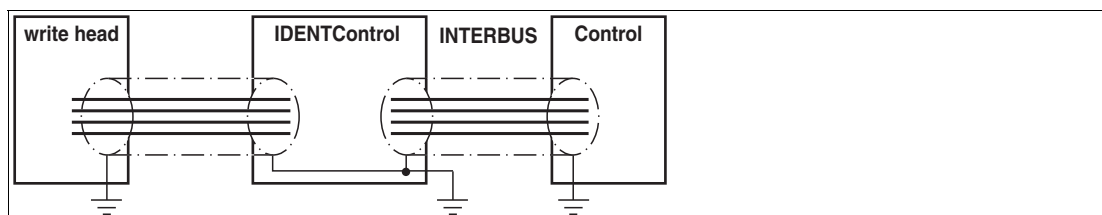

The cable shielding is used to discharge electromagnetic interference. When shielding a cable, you must connect both sides of the shield to ground with low resistance and low inductance.

Note

If cables with double shields are used, e.g. wire mesh and metalized foil, the both shields must be connected together, with low resistance, at the ends when making up the cable.

Power supply cables are the source of much interference, e.g. from the supply lines of 3-phase electric motors. For this reason, the parallel laying of power supply cables with data and signal cables should be avoided, particularly in the same cable duct.

Note

The circuit ground is conductively connected to the housing of the write/read head and to the protective ground. (Connection image → see Figure 3.6 on page 21)

5 Commissioning

5.1 Definitions

5.1.1 Display

Angle brackets contain the abbreviated meaning of a command structure, e.g., <Data>

The index _{hex} or .xx denotes a hexadecimal number.

hex_{ASCII} denotes a value in the hexadecimal system, specified in ASCII characters.

Example: 10_{dec} corresponds to A_{hex}; A_{ASCII} corresponds to 41_{hex}. see chapter 9.2

5.1.2 Legend

<ChanNo>:	IDENT <i>Control</i> channel
<CHCK>:	1 byte, 8-bit check sum with the addition of all preceding characters, without overflow
<Data>:	Data with the size <WordNum> multiplied by 4 bytes
<DataLength>:	Length of the data specified to a command, 2 characters binary, HighByte, LowByte
eirp:	equivalent isotropically radiated power
erp:	effective radiated power
<ETX>:	1 byte = 03 _{hex}
<read-only code>:	TID, 4 bytes + an optional 4 or 8 bytes
<Ldata>:	Length of the data in bytes, 2 bytes Use in multiframe protocol
<Length>	1 character hex _{ASCII} = number of data bytes Permitted values in the read/write head IUH*: 2, 4, 6, 8, A, C, E
<Luii>:	Length of the UII in bytes, 2 bytes Use in multiframe protocol
<LogicalOperation>:	Links several filters; OR = 0; AND = 1 If one filter only is used, this value is ignored
<MaskData>:	Mask specification
<MaskLength>:	Mask length in bits, values: 00...FF
<MemBank>:	Number of the memory bank (see parameter MB)
<ParamTyp>:	Parameter type, 2 bytes, or 2 ASCII characters
<Negate>:	Negates the mask comparison; not negated = 0; negated = 1
<PC>:	Protocol control word according to EPC Gen 2 (ISO/IEC 18000-63), 2 bytes, describes characteristics such as the length of the UI/EPC
<SpecialFixcode>:	<PC> & <UII/EPC>
<Status>:	1 ASCII character (see chapter 6.7)
<StartAddress>:	Start address in the selected memory bank in bits, values: 0000...FFFF
<SystemCode>:	= U (for read/write head IUH*)
<TagType>:	2 ASCII characters
<UII/EPC>:	Unique Item Identifier, memory area of a tag in accordance with EPC Gen 2 (ISO/IEC 18000-63), in which the EPC code is stored

<WordAddr>:	Word start address in the read/write tag, 4 hex _{ASCII} characters, range from "0000h" to "FFFF", depending on tag type
<WordNum>:	Number of words to be read or written, 2 hex _{ASCII} characters. Range from "01" through "20" depending on the tag type, word lengths are 4 bytes

5.2 Initial Commissioning



Note

Transmission License

A country-specific transmission license is required to operate the read/write head. In the European Union and Turkey, the manufacturer's EU declaration of conformity constitutes an adequate license. A currently valid transmission license may not exist for all countries of use listed in this chapter, as transmission licenses are temporary in some countries. All currently valid transmission licenses can be found in the data sheet for the respective read/write head at www.pepperl-fuchs.com



Warning!

Malfunctions with pacemakers

This device does **not** exceed the permissible limits for electromagnetic fields. Maintain a minimum distance of 30 cm between the device and your pacemaker.

Inadequate distance from the read/write head can result in inhibitions, reprogramming, or incorrect stimulation pulses.

All IUH-F192-V1-* read/write heads operate within their maximum frequency range from 865 MHz to 868 MHz, or from 902 MHz to 928 MHz, with the appropriate settings for the relevant country. This enables the following parameters to be set according to the applicable regulations for the relevant country:

- The maximum occupied bandwidth
- The channel bandwidth
- The channel plan used
- The frequency access method
- The maximum power setting



Note

Country Identifier

The IUH-F192-V1-FR* read/write head has no valid country identifier by default. This status is indicated by the flashing green LED. In this state, the read/write head will accept only the command for setting the relevant country identifier. Once you have parameterized a valid country identifier, you can begin using the read/write head.

The IUH-F192-V1-FR2-02 is supplied ex-works with the country identifier "02" for the USA, Canada, and Mexico. Due to legal regulations, you cannot change this country identifier in the IUH-F192-V1-FR2-02.



Note

The country identifier set is saved in the read/write head as non-volatile. The country identifier setting is not affected by a reset to the factory settings. It can be overwritten with another valid country identifier at any time.

Country identifiers for IUH-F192-V1-FR1

(The currently valid transmission licenses can be found in the data sheet at pepperl-fuchs.com)

Country Identifier	Occupied Frequency Bandwidth Frequency Access Method	Country or Region
01	865.6 MHz – 867.6 MHz Parameterizable frequency list	EU and other countries subject to EN 302208
04	865.0 MHz – 867.0 MHz Parameterizable frequency list	India
05	866.0 MHz – 868.0 MHz Parameterizable frequency list	Singapore
15	867.6 MHz – 868.0 MHz Parameterizable frequency list	Morocco

Country identifiers for IUH-F192-V1-FR2

(The currently valid transmission licenses can be found in the data sheet at pepperl-fuchs.com)

Country Identifier	Occupied Frequency Bandwidth Frequency Access Method	Country or Region
02	902 MHz – 928 MHz Frequency hopping spread spectrum	USA Canada Mexico Argentina
03	920 MHz – 925 MHz Frequency hopping spread spectrum	China
07	915 MHz – 928 MHz Frequency hopping spread spectrum	Brazil, Columbia
08	916.7 MHz – 920.5 MHz Parameterizable frequency list	Japan
09	917.2 MHz – 920.4 MHz Frequency hopping spread spectrum	South Korea
10	920 MHz – 926 MHz Frequency hopping spread spectrum	Australia
11	921.5 MHz – 928 MHz Frequency hopping spread spectrum	New Zealand
12	920 MHz – 925 MHz Frequency hopping spread spectrum	Hong Kong Thailand
13	919 MHz – 923 MHz Frequency hopping spread spectrum	Malaysia
14	920 MHz – 925 MHz Frequency hopping spread spectrum	Singapore

For technical details regarding the regional settings, see chapter 3.3. For an example of reading and writing the country identifier, see chapter 5.3.

5.3 Sensor Settings



Warning!

Device not configured or configured incorrectly

Configure the device prior to commissioning. A device that has not been configured or configured incorrectly may lead to faults in the plant.



Warning!

L'appareil non configuré ou mal configuré

Configurez l'appareil avant de l'utiliser. Un périphérique mal configuré peut provoquer des erreurs dans le système.

You must configure the control interface before commissioning the IUH-F190-V1-* read/write head. To do so, refer to the "Commissioning" chapter of the manual for your control interface.

Configure the read/write heads with the described system commands (). For a parameterization example, see see chapter 5.4.



Caution!

Uncontrolled triggered processes

Before commissioning the device, make sure that all processes are running smoothly; otherwise damage may occur in the plant.



Caution!

Processus déclenchés incontrôlés

Avant la mise en service de l'appareil, assurez-vous que tous les processus fonctionnent de manière contrôlée, sinon vous risquez d'endommager le système.

5.4 Operation via the Command Interface

This section shows you how to commission the IUH-F190-V1-* read/write head using an IDENTControl control interface with serial interface. The commissioning procedure described relates to the RS-232 interface and involves a PC. The examples include the syntax for coding the commands and parameters via the Ethernet TCP/IP and PROFIBUS/PROFINET interfaces. Further details about these codes and the factory settings for your IDENTControl control interface can be found in the corresponding manual.

The commissioning of the IUT-F190-R4-V1-* read/write head with integrated RS-485 interface is also carried out using the above commands and parameters. For details regarding the IUT F190-R4-V1-* read/write head

Example:

In the examples below, the read/write head is connected to channel 1 of the control interface.

The outputs follow the multiframe protocol, see table "Responses Depending on Protocol Mode QV" on page 55.



Reading Tags

Enhanced Read Read-Only Code

Send the enhanced read read-only code command to the read/write head. The "RF ON" LED on the read/write head lights up blue.

	Serial	Ethernet	PROFIBUS/PROFINET
Command:	EF1	.00.04.1D.03	.1D.03
Confirmation:	-	.00.06.1D.03.FF.0B	.1D.03.FF.0B
Response:	.35.31	.00.06.1D.03.05.0C	.1D.03.05.0C

Table 5.1 Enhanced read read-only code, no tag in the detection range

Move a tag into the read/write head's detection range. When the tag has been detected and the read-only code has been read out, the "READ / WRITE" LED on the read/write head lights up yellow. The read-only code is displayed in the terminal program.

	Serial	Ethernet	PROFIBUS/PROFINET
Response:	.30.31.00.0E.30.00.30.14.F7.33.7C.00.1F.00.00.00.00.01.00.08.E2.00.60.03.14.42.D6.D1	.00.20.1D.03.00.0D.00.0E.30.00.30.14.F7.33.7C.00.1F.00.00.00.01.00.08.E2.00.60.03.14.42.D6.D1	.1D.03.00.0D.00.0E.30.00.30.14.F7.33.7C.00.1F.00.00.00.01.00.08.E2.00.60.03.14.42.D6.D1

Table 5.2 Enhanced read read-only code, tag is entering the detection range



Describing Tags

Single Write Special Read-Only Code

Send the single write special read-only code command to the read/write head while a tag is in the detection range. See "Single Write Special Read-Only Code SP" on page 40 and see chapter 3.2.4.

	Serial	Ethernet	PROFIBUS/PROFINET
Command:	SP1E.30.00.30.14.F7.33.7C.00.1F.00.00.03.1C.6E	.00.14.0D.E3.00.00.30.00.30.14.F7.33.7C.00.1F.00.00.03.1C.6E	.0D.E3.00.00.30.00.30.14.F7.33.7C.00.1F.00.00.03.1C.6E
Confirmation:	-	.00.06.0D.E3.FF.2D	.0D.E3.FF.2D
Response:	.30.31.00.0E.30.00.30.14.F7.33.7C.00.1F.00.00.03.1C.6E.46.31.30.30.30.31	.00.16.0D.03.00.2E.00.0E.30.00.30.14.F7.33.7C.00.1F.00.00.03.1C.6E.00.0A.0D.03.0F.2F.30.30.30.31	0D.03.00.2E.00.0E.30.00.30.14.F7.33.7C.00.1F.00.00.03.1C.6E.0D.03.0F.2F.30.30.30.31

Single Read Special Read-Only Code

As confirmation, read out the read-only code of the tag within the read/write head's detection range via the single read special read-only code command. See "Single Read Special Read-Only Code SS" on page 39.

	Serial	Ethernet	PROFIBUS/PROFINET
Command:	SS10	.00.04.0A.02	.0A.02
Confirmation:	-	.00.06.0A.02.FF.30	.0A.02.FF.30
Response:	.30.31.00.0E.30. 00.30.14.F7.33.7 C.00.1F.00.00.03 .1C.6E .46.31.30.30.30.3 1	.00.16.0A.02.00.31.00.0E. 30.00.30.14.F7.33.7C.00.1 F.00.00.03.1C.6E .00.0A.0A.02.0F.32.30.30. 30.31	.0A.02.00.31.00.0E.30.00. 30.14.F7.33.7C.00.1F.00.0 0.03.1C.6E .0A.02.0F.32.30.30.30.31



Parameterizing the Read/Write Head

Requesting and Setting the Transmission Power

Read out the read/write head's transmission power with the read parameter PT command:

	Serial	Ethernet	PROFIBUS/PROFINET
Command:	RP1UPT.00.00	.00.0A.BE.03.00.55.50.54. 00.00	.BE.03.00.55.50.54.00.00
Confirmation:	-	.00.06.BE.03.FF.33	.BE.03.FF.33
Response:	.30.31.00.32	.00.0A.BE.03.00.34.00.02. 00.32	.BE.03.00.34.00.02.00.32

The read/write head's set transmission power is 50 mW (32_{hex} corresponding to 50_{dec}).

Change the transmission power of the read/write head to 100 mW (100_{dec} corresponding to 64_{hex}) via the write parameter PT command:

	Serial	Ethernet	PROFIBUS/PROFINET
Command:	WP1UPT.00.02.0 0.64	.00.0C.BF.03.00.55.50.54. 00.02.00.64	.BF.03.00.55.50.54.04.00. 02.00.64
Confirmation:	-	.00.06.BF.03.FF.35	.BF.03.FF.35
Response:	.30.31	.00.06.BF.03.00.36	.BF.03.00.36

6 Operation

6.1 General

The sections below contain information about the commands that relate to your read/write head. The commands are described using the example of an IDENTControl control interface with serial interface. All other generally applicable commands and error messages or status messages can be found in the manual for your IDENTControl control interface.

Commissioning of the IUT-F190-R4-V1-* read/write head with integrated RS-485 interface is also carried out using the commands and parameters described. For details regarding the IUT F190-R4-V1-* read/write head

6.2 Interference Due to Multipath Propagation

The electromagnetic waves radiated by the read/write device do not just follow the direct route to the tag, but are also reflected off objects in the vicinity, meaning that multiple partial waves overlap with the waves radiated by the read/write device.

This overlap causes interference (i.e., exaggeration and dampening of the reception field strength), leading to almost complete degradation. Depending on the environment, several reflections may occur with differing intensity and distance. These different reflections lead to a field strength in the measurement range that is difficult to predict. In the areas of degradation, the prevailing field strength is weaker than the minimum detection field strength of the tag. As a result, the tag cannot be activated for communication. Exaggeration of the field strength may lead to unwanted excessive detection ranges.

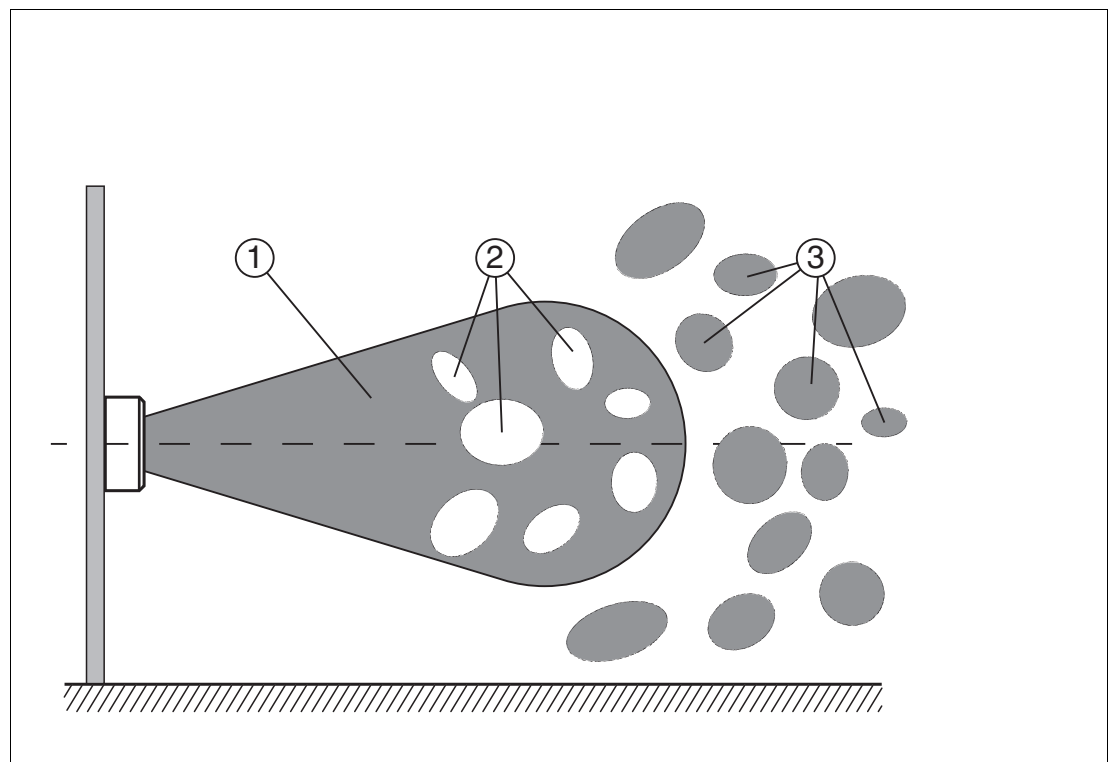

1. Detection range
2. Degradation
3. Excessive detection ranges

The reflections and the resulting spatial inhomogeneity of the field strength depend on the frequency used. The absolute value of the field strength depends on the transmission power. Since the tags move in the measurement range of the read/write device, and the environment can change, it is advisable to repeat the commands at different transmission frequencies and at varying power. Different transmission frequencies are advisable, since the manufacturing tolerances and the immediate environment of the tag have an effect on the tag's resonance frequency.

6.3 Command Overview

The commands in the list are described in detail on the following pages.

The following uses the command syntax for the IUH-F190-V1-* read/write heads with IDENT-Control serial control interface. The channel number <ChanNo> is always included in the commands. The command syntax is identical to the syntax of the IUT-F190-R4-V1-* read/write heads with integrated RS-485 interface, except for the channel number. For the IUT-F190-R4-V1-* read/write heads, the channel number <ChanNo> is not included in single-drop mode. In multi-drop mode, the channel number <ChanNo> is replaced by the device address <DeviceNo>.

Read/Write Commands

Abbreviation	Command description
SF	See "Single Read Read-Only Code SF" on page 39
EF	See "Enhanced Read Read-Only Code EF" on page 39
SS	See "Single Read Special Read-Only Code SS" on page 39
ES	See "Enhanced Read Special Read-Only Code ES" on page 40
SP	See "Single Write Special Read-Only Code SP" on page 40
SR, #SR	See "Single Read Words SR" on page 41
ER, #ER	See "Enhanced Read Words ER" on page 41
SW, #SW	See "Single Write Words SW" on page 42
EW, #EW	See "Enhanced Write Words EW" on page 42
KI	See "Kill UHF Tag KI" on page 43

Filter Commands

Abbreviation	Command description
FI	See "Set Filter Mask FI" on page 43
MF	See "Activate/Deactivate Filter MF" on page 45

Configuration Commands

Abbreviation	Command description
RP	See "Read Parameters" on page 49
WP	See "Write Parameters" on page 49

6.4 Read/Write Commands

The tag's memory structure is based on the following read/write commands in accordance with EPC Gen 2 (ISO/IEC 18000-63). See chapter 3.2.3.

Single Read Read-Only Code SF

One attempt is made to read a read-only code (TID). The read-only code is 4, 8, or 12 bytes long, and comprises a 4-byte part number, which denotes the tag type, and optionally a tag with a unique serial number of 4 or 8 bytes. Details see chapter 3.2.3.

Command: SF <ChanNo> <CHCK> <ETX>
 Response: <Status> <ChanNo> <Luii> <Ull> <Length> <Fixcode> <CHCK> <ETX>
 F <ChanNo> 0001 <CHCK> <ETX>

<Length> = Length of the <Fixcode> in ASCII_{hex}

Example:

SF1 reads the read-only code to IDENT*Control* channel 1.

Enhanced Read Read-Only Code EF

This command continuously attempts to read a read-only code (TID). If a read-only code is read, this is reported once. If there is no tag in the detection range, or if the tag leaves the detection range, a status 5 message is reported.

Command: EF <ChanNo> <CHCK> <ETX>
 Response: <Status> <ChanNo> <Luii> <Ull> <Length> <Fixcode> <CHCK> <ETX>

<Length> = Length of the <Fixcode> in ASCII_{hex}

Example:

EF1 continuously reads the read-only code to IDENT*Control* Channel 1

Single Read Special Read-Only Code SS

This command reads the Ull segment from tags according to EPC Gen2 (ISO/IEC 18000-63).

Command: SS <ChanNo> 0 <CHCK> <ETX>
 Response: <Status> <ChanNo> <Length> <SpecialFixcode> <CHCK> <ETX>
 F <ChanNo> 0001 <CHCK> <ETX>

Example:

SS10 reads the entire Ull segment.

The tag type determines the maximum length of the Ull/EPC. The actual length of the Ull/EPC is defined via the protocol control word <PC>. The data is structured as follows:

<Length> = Length of the <SpecialFixcode> in ASCII_{hex}

<SpecialFixcode> = <PC> & <Ull/EPC>

<PC> corresponds to the protocol control word in accordance with EPC Gen 2 (ISO/IEC 18000-63), 2 bytes long.

<Ull/EPC> contains the usage data.

Note

Ull/EPC

If there are multiple tags in the measurement range with the same Ull/EPC, the identical tags are reported with Status A.



Enhanced Read Special Read-Only Code ES

This command continuously attempts to read the UII segment from tags according to EPC Gen 2 (ISO/IEC 18000-63). If the <SpecialFixcode> of a tag is read, this is reported once. If there is no tag in the detection range, or if the tag leaves the measurement range, a status 5 is reported.

Command: ES <ChanNo> 0 <CHCK> <ETX>

Response: <Status> <ChanNo> <Length> <SpecialFixcode> <CHCK> <ETX>

Example:

ES10 continuously reads the UII segment.

The tag type determines the maximum length of the UII/EPC. The actual length of the UII/EPC is defined via the protocol control word <PC>. The data is structured as follows:

<Length> = Length of the <SpecialFixcode> in ASCII_{hex}

<SpecialFixcode> = <PC> & <UII/EPC>

<PC> corresponds to the protocol control word in accordance with EPC Gen 2 (ISO/IEC 18000-63), 2 bytes long.

<UII/EPC> contains the usage data.

Note

UII/EPC

If there are multiple tags in the measurement range with the same UII/EPC, the identical tags are reported with Status A.

Single Write Special Read-Only Code SP

This command writes a <Length> octet long UII/EPC code to tags according to EPC Gen 2 (ISO/IEC 18000-63).

Command: SP <ChanNo> <Length> <SpecialFixcode> <CHCK> <ETX>

Response: <Status> <ChanNo> <NUL> <Length> <SpecialFixcode> <CHCK>
<ETX> F <ChanNo> 0001 <CHCK> <ETX>

The data length <Length> must be a whole number multiple of 2 octets because in accordance with EPC Gen 2 (ISO/IEC 18000-63), <UII/EPC> must be written in 16-bit words. Only the lengths 2_{dec} , 4_{dec} , ... 14_{dec} ($= 2_{ASCII}$, 4_{ASCII} , ..., E_{ASCII}) are permissible. The length is shown in hexadecimal format, and includes the length of PC and UII/EPC. If a UII/EPC of 96 bits is written, this results in $2 + 12 = 14$ octets = E_{ASCII} octet.

<Length> = Length of the <SpecialFixcode> in ASCII_{hex}

<SpecialFixcode> = <PC> & <UII/EPC>

<PC> corresponds to the protocol control word in accordance with EPC Gen 2 (ISO/IEC 18000-63), 2 octets long.

<UII/EPC> contains the usage data.

Example:

SP1E.30.00.30.14.F7.33.7C.00.1F.00.00.03.1C.6E writes the value ".30.00" for <PC>, and the UII/EPC code ".30.14.F7.33.7C.00.1F.00.00.03.1C.6E" with a length of $2 + 12$ octets = 14 octets to IDENTControl channel 1.

When using this command, make sure that the protocol control word contains the correct length of the following UII/EPC. If this is not executed correctly, the complete data is not output on the subsequent read operation because the command SS uses the length in the protocol control word for the output.

In accordance with EPC Gen 2 (ISO/IEC 18000-63), the protocol control word consists of two octets. The five highest value bits denote the length of the <UII/EPC> in words ($= 16$ bit):

2024-08

00000 _{bin}	No word	0 bits
00001 _{bin}	One word	16 bits
00010 _{bin}	Two words	32 bits
...
11111 _{bin}	31 words	496 bits

The meaning of the remaining bits is described in EPC Gen 2 (ISO/IEC 18000-63). If a UII/EPC has the length 12 octets, i.e., 6 words (00110_{bin}), and all other bits are equal to 0, the protocol control word corresponds to 00110000 00000000_{bin} or 3000_{hex}. If some of the other bits are not equal to 0, this produces a different protocol control word.



Note

Several Tags in the Measurement Range

If there is more than one tag in the measurement range when this command is run, the UII is written to the first tag only. Status A is output for all other tags.

Single Read Words SR

One attempt is made to read <WordNum> 32-bit words from address <WordAddr>.

Command: SR <ChanNo> <WordAddr> <WordNum> <CHCK> <ETX>
 Response: <Status><ChanNo><Luii><UII><Ldata><Data><CHCK> <ETX>
 F <ChanNo> 0001<CHCK> <ETX>

Example:

SR1000101 reads a 4-byte word from memory address "0001".



Note

The memory bank (**MB**) parameter defines the bank accessed by this command. see "Memory Module for Tag Accesses to the "Memory Bank" MB" on page 52.

Enhanced Read Words ER

Continuous attempts are made to read <WordNum> 32-bit words from the address <WordAddr>. Only changing data is transferred via the interface. When a read/write tag leaves the read range, status 5 is output.

Command: ER <ChanNo> <WordAddr> <WordNum> <CHCK> <ETX>
 Response: <Status><ChanNo><Luii><UII><Ldata><Data><CHCK> <ETX>

Example:

ER1000101 continuously reads a 4-byte word from memory address "0001".



Note

The memory bank (**MB**) parameter defines the bank accessed by this command. see "Memory Module for Tag Accesses to the "Memory Bank" MB" on page 52.

Single Write Words SW

One attempt is made to write <WordNum> 32-bit words from the address <WordAddr>.

Command: SW <ChanNo> <WordAddr> <WordNum> <Data> <CHCK> <ETX>
 Response: <Status> <ChanNo> <Luii> <UII> <CHCK> <ETX>
 F <ChanNo> 0001 <CHCK> <ETX>

Example:

SW1000101ABCD writes the 4-byte-long word "ABCD" from memory address "0001".



Note

The memory bank (**MB**) parameter defines the bank accessed by this command. see "Memory Module for Tag Accesses to the "Memory Bank" MB" on page 52.



Note

When writing to the UII/EPC area (MB = 1), note that it is not possible to write to the CRC. The first writable address is 0x0001. The protocol control word <PC> begins at this address. Use the command #SW.

Enhanced Write Words EW

This command continuously attempts to write <WordNum> 32-bit words from the address <WordAddr>. If the command was executed successfully, a status 0 is reported. If there is no tag in the detection range, or if the tag leaves the detection range, a status 5 is reported.

Command: EW <ChanNo> <WordAddr> <WordNum> <Data> <CHCK> <ETX>
 Response: <Status> <ChanNo> <Luii> <UII><CHCK> <ETX>

Example:

EW1000101ABCD continuously writes the 4-byte long word "ABCD" from memory address "0001".



Note

The memory bank (**MB**) parameter defines the bank accessed by this command. see "Memory Module for Tag Accesses to the "Memory Bank" MB" on page 52.



Note

16-Bit Read/Write Commands

The read/write commands SR, ER, SW, and EW are interpreted as 16-bit versions by means of a preceding # symbol.

The 16-bit read/write commands behave in the same way as the 32-bit versions.

- 16-bit commands write or read a word with a length of 2 bytes.
- 32-bit commands write or read a word with a length of 4 bytes.

Example:

#SW1000202ABCD corresponds to SW1000101ABCD

Kill UHF Tag KI

This command sets a UHF tag to a state where no further access is possible. The command can be executed only if a valid password has previously been set in segment Bank 00 via the command SW. See chapter 3.2.3. The password must have at least 1 non-zero bit.

Command: KI <ChanNo>.30.30 <UllLength>< UIIData> <PassWord> <RecomBits>
<CHCK> <ETX>
Response: <Status> <ChanNo> <Luii> <UII> <CHCK> <ETX>
F <ChanNo> 0001 <CHCK> <ETX>

<UllLength> = Mask length for the UII/EPC in bits, values: 00 ... FF, always begins at Address 0. The information is entered as 2 hex_{ASCII} characters.

<UIIData> = Specification of the mask for the UII, in octets

<PassWord> = Password for killing a UHF tag, 4 octets

<RecomBits> = Recommission bits, always set to zero

Example:

KI10018.E2.00.90abcd.00 kills a UHF tag with a UII starting ".E2.00.90" and using the password "abcd."

6.5 Filter Commands

Each read or write command can access one, several, or all tags in a measurement range. The process is controlled by filter masks, which are managed via the commands Set Filter Mask (FI) and Activate/Deactivate Filter (MF). These commands allow you to detect specific tags in the measurement range. see chapter 6.5.

Set Filter Mask FI

Using command FI, you can define a filter mask for accessing the tags located in the box. You can define up to 3 filters (0-2). The following syntax is used:

Command: FI <ChanNo> <FilterNumber> <MemBank> <Negate> <LogicalOperation> 0 <StartAddress> <MaskLength> <MaskData> <CHCK> <ETX>
Response: <Status> <ChanNo> <CHCK> <ETX>

<MemBank> = Memory segment to which the filter is to be applied. The information is entered as one hex_{ASCII} character.

<StartAddress> = Address of the bit at which the filter mask begins. Specified in hex_{ASCII}. Values: 0000 ... FFFF

<MaskLength> = Length of the mask in bits. The information is entered as 2 hex_{ASCII} characters.

<MaskData> = Defines the actual filter mask

Example:

There are three tags in the measurement range of the read/write head. Each tag has a unique identifier of <PC> & <UII/EPC>:

	<PC> & <UII/EPC>
1. Tag	.34.00.E2.00.92.01.20.51.70.00.00.00.02.76
2. Tag	.34.00.E2.00.92.01.20.51.70.00.00.00.02.66
3. Tag	.34.00.E2.00.90.51.33.02.00.92.18.20.56.15

If you want to detect the 3rd tag, the filter mask is: **FI101000001028.34.00.E2.00.90**

Meaning of Bits

Command	FI	=	Command
<ChanNo>	1	=	Channel 1
<FilterNumber>	0	=	First filter used, filter number = 0
<MemBank>	1	=	Memory bank 01; should be filtered to UII/EPC
<Negate>	0	=	Not negated
<LogicalOperation>	0	=	OR link not relevant here because only one filter is set
0	0	=	Value is always 0
<StartAddress>	0010	=	Start address 10 _{hex} or bit 16
<MaskLength>	28	=	Mask length, 28 _{hex} = 40 _{dec} , i.e., 40 bits
<MaskData>	34.00.E2.00.90	=	Actual Mask

Owing to the structure of the memory bank for UII/EPC (→ see image on page 11), the start address is located at bit 16. The CRC-16 value occupies the memory position from bit 0 through bit 15; the PC starts at bit 16.

If you activate the filter with the command MF, and then execute command SS10, you receive only one response from the corresponding tag even if other tags are located in the measurement range:

```
.34.00.E2.00.90.51.33.02.00.92.18.20.56.15
```

The value <Negate> controls the mask comparison. 0 = not negated, 1 = negated. If you negate the filtering by setting the value <Negate> in the command FI101100001028.34.00.E2.00.90, you receive a response from the tags that does not match the filter:

```
.34.00.E2.00.92.01.20.51.70.00.00.00.02.76
```

```
.34.00.E2.00.92.01.20.51.70.00.00.00.02.66
```

If you prefer to filter only at the start of <UII/EPC>, and ignore the <PC>, send the command FI10100000**2018**.E2.00.90. The start address is 20_{hex}, the mask length has 24 bits, and the mask is .E2.00.90.

The value <LogicalOperation> logically links several filters with each other and is evaluated only if more than one filter is used. If only one filter is used, this value is ignored. 0 = OR, 1 = AND

Other examples include:

FI102000000018.**E2.00.10** sets filter 0 so that all tags with a TID beginning with .E2.00.10 are detected.

FI111100002008.22 sets filter 1 so that all tags whose UII/EPC do not begin .22 are detected.

FI1010100010700.**00123456789012** sets filter 0 so that the tag with the SpecialFixcode (PC+UII/EPC) 0.00123456789012 is detected.

The letter x can be used as a wildcard for the channel and filter number. Command FIxx0000000000 resets the three filters for all IDENT*Control* channels.

Activate/Deactivate Filter MF

Command MF activates or deactivates the filter masks.

Command: MF<ChanNo><Value><CHCK><ETX>

Response: <Status><ChanNo><CHCK><ETX>

The following values are possible:

0 = Deactivate filter masks

1 = Activate filter masks - mode 1

2 = Activate filter masks - mode 2

Example:

MF11 activates the filter masks for IDENTControl channel 1

Command MF - Mode 1

In total, there are 15 tags in the measurement range of the read/write head, with three groups of five marked as either A, B, or C. The filter is now set to "B" by the command FI.

If you execute command MF11 (Activate Filter - Mode 1), this command affects all subsequent commands.

If a write command is executed next, all "B" tags in the measurement range are selected and are assigned a 'Selected' flag. The write command is executed only for tags with a Selected flag.

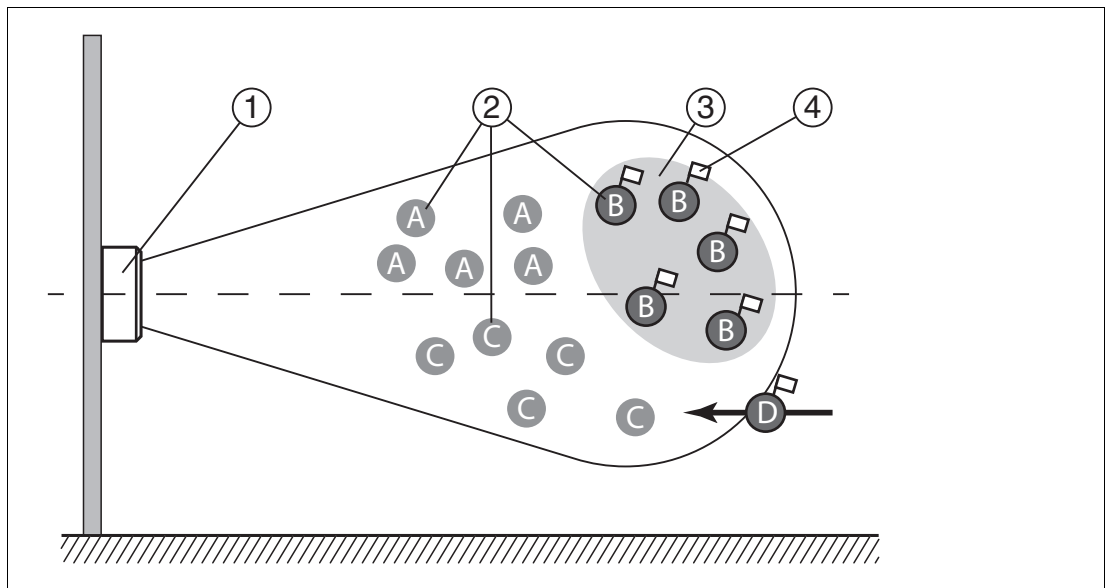

When the filter is set to "B", command MF11 (Filter Activated - Mode 1) selects all "B" tags; the following commands address the selected "B" tags.

- 1 Read/write head
- 2 Tags "A", "B", "C"
- 3 Filter mask
- 4 Selected flag

Command MF - Mode 2

In total, there are 15 tags in the measurement range of the read/write head, with three groups of five marked as either A, B, or C. The filter is set to "B" by command FI.

If you execute command MF12 (Activate Filter - Mode 2), this command affects all subsequent commands.

If a write command is executed next, all tags in the measurement range that are not "B" tags are selected. These tags are assigned a 'Selected' flag. The write command is executed only for tags with no Selected flag.

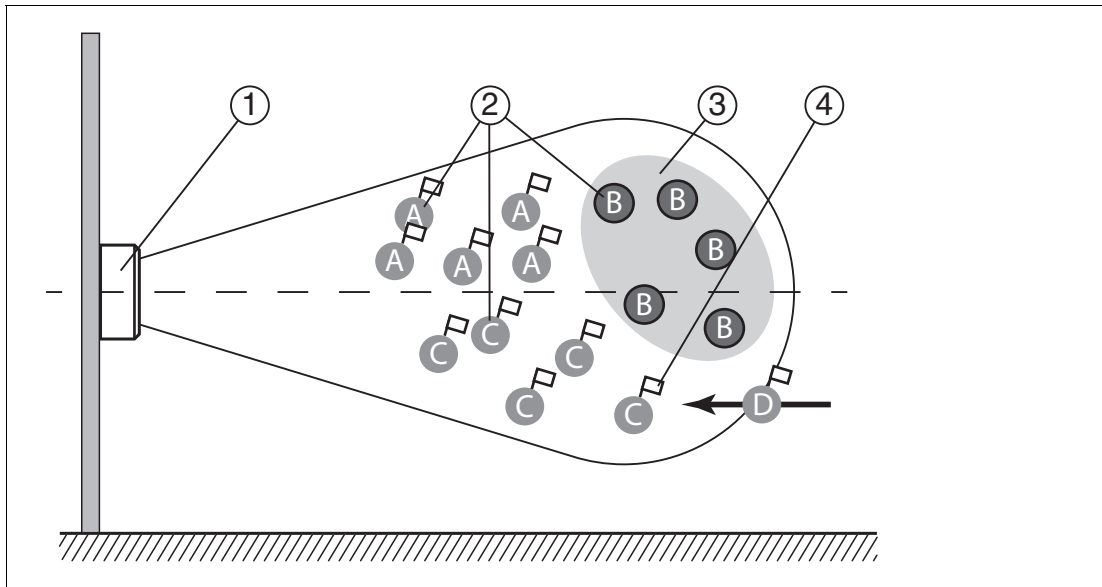

When the filter is set to "B," command MF12 (Filter Activated - Mode 2) selects all "A" and "C" tags, and the following commands address the **unselected** "B" tags.

- 1 Read/write head
- 2 Tags "A", "B", "C"
- 3 Filter mask inverted
- 4 Selected flag

Difference Between Command MF - Mode 1 and Command MF - Mode 2

In both cases, the subsequent commands are applied only to the "B" tags in the measurement range.

With MF11, "B" tags are assigned a Selected flag. With MF12, "B" tags are not assigned a Selected flag.

If a "D" tag with a Selected flag from the operation of a different read/write head enters the measurement range, this "D" tag will execute the subsequent commands if MF11 is activated. If MF12 is activated, this "D" tag will not execute the subsequent commands.

6.6 Configuration Commands

The response to a configuration command is a status message from the read/write device. During the read operation, a status message and the corresponding data are received as the response.

6.6.1 ChangeTag Command

This command tells the R/W system with which tag type to communicate.

Command: CT <ChanNo> <TagType> <CHCK> <ETX>

Response: <Status> <ChanNo> <CHCK> <ETX>

Default: 80

Example:

CT180 sets the tag type for IDENTControl channel 1 to IUC80

CT180 sets a generally valid tag type, which allows the read-only code to be read out for each tag, and therefore provides information about the chip type of the tag.



Note

The read/write head uses only tag type 80.

Tag Types, UHF

Tag type	Chip		Peperl+ Fuchs des- ignation	Bank 00 [bit]	UII/EPC [bit]	TID		User data [octet]
	Type	Designation				Type	Unique?	
72	EPC Class 1 Gen 2	NXP UCode- EPC-G2XM	IUC72	32 + 32	240	E2006003 _{hex} + seq. no.	Yes	64
76	EPC Class 1 Gen 2	Alien Higgs-3	IUC76	32 + 32	96 – 480 ²⁾	E2003412 _{hex} + seq. no.	Yes	8 – 64 ²⁾
77	EPC Class 1 Gen 2	Impinj Monza 4QT	IUC77	32 + 32	128	E2801105 _{hex} + seq. no.	Yes	64
78	EPC Class 1 Gen 2	Impinj Monza 5	IUC78	32 + 32	128	E2801130 _{hex} + seq. no.	Yes	4
79	EPC Class 1 Gen 2	NXP UCode G2iM	IUC79	32 + 32	256	E2800680A _{hex} + seq. no.	Yes	64
80	EPC Class 1 Gen 2	Read/write tag conforms with Class 1 Gen 2	IUC80	1)	1)	E2xxxxxx _{hex} + seq. no.	1)	1)

Table 6.1

Tag types

1) = depending on the tag type

2) = EPC expandable to max. 480 bits. If a 480 bit EPC format is used, the user data is reduced from 64 octets to 8 octets.

6.6.2 Read and Write Parameters

With the read parameter (**RP**) and write parameter (**WP**) configuration commands, you can read/write the following parameters:

Abbreviation	Page	Parameter IUH-F192-V1-FR*
AP	See "Antenna Polarization AP" on page 49	Readable/writeable
CD	See "CD Transmission Channels" on page 50	Readable/writeable for RC = 1, 4, 5, 6, 8 Readable for RC = 2, 3, 7, 9, 10, 11, 12, 13, 14
E5	See "Number of Unsuccessful Attempts until Status 5 "Enhanced Status 5" E5" on page 50	Readable/writeable
FL	See "Read Out Filter Mask "Filter List" FL" on page 51	Readable
IF	See "Output Additional Information, "Information" IF" on page 51	Readable/writeable
MB	See "Memory Module for Tag Accesses to the "Memory Bank" MB" on page 52	Readable/writeable
MD	See "Retrieve Additional Information MD" on page 52	Readable
MF	See "Measurement of Reflected Transmitting Power "Measure Reflection" MF" on page 52	Readable
NC	See "Number of Channels NC" on page 53	Readable/writeable for RC = 2, 3, 7, 9, 10, 11, 12, 13, 14 Readable for RC = 1, 4, 5, 6, 8
NT	See "Search Algorithm Cancellation Criteria "number of tags to find" NT" on page 53	Readable/writeable
PT	See "Transmission Power "Power Transmit" PT" on page 53	Readable/writeable
QV	See "Protocol Mode QV" on page 54	Readable/writeable
QW	See "Q Value QW" on page 56	Readable/writeable
RC	See "Country Identifier, "Region Code" RC" on page 56	Readable/writeable ¹
RD	See "Reset to Default, RD" on page 58	Writeable
SM	See "Transmission Pauses in "Sensing Mode" SM" on page 59	Readable/writeable
TA	See "Number of Attempts "Tries Allowed" TA" on page 59	Readable/writeable

1. Readable only for IUH-F192-V1-FR2-02

The parameters are saved in the read/write head as nonvolatile.

Read Parameters

The RP command reads configuration parameters from the read/write head.

Command: RP <ChanNo> <SystemCode> <ParamTyp> <DataLength> <Data>
<CHCK> <ETX>

Response: <Status> <ChanNo> <Data> <CHCK> <ETX>

<SystemCode> = U_{ASCII} for IUH-*

<ParamTyp> = 2 bytes ASCII

<DataLength> = Length of <Data> in command, 2 bytes binary

<Data> = Optional additional information

Example:

RP1UE5.00.00 outputs the number of unsuccessful read attempts until status 5.

Write Parameters

Command WP writes configuration parameters to the read/write head.

Command: WP <ChanNo> <SystemCode> <ParamTyp> <DataLength> <Data>
<CHCK> <ETX>

Response: <Status> <ChanNo> <CHCK> <ETX>

<SystemCode> = U_{ASCII} for IUH-*

<ParamTyp> = 2 bytes ASCII

<DataLength> = Length of <Data>, 2 bytes binary

<Data> = Optional additional information

Example:

WP1UE5.00.01.05 sets the number of unsuccessful read attempts to status 5 on 5 attempts.

6.6.3 Parameters

Antenna Polarization AP

This parameter switches polarization to horizontally linear, vertically linear, or combined mode, or reads out the polarization currently set.

ParamTyp: AP

Default: AP = C

Value range: C = combined ¹
H = Horizontally linear
V = Vertically linear

1. Combined horizontally linear and vertically linear for each read/write attempt

Example:

WP1UAP.00.01H switches the polarization to horizontally linear

WP1UAP.00.01C switches the polarization to combined mode

RP1UAP.00.00 reads out the set polarization

Set the polarization to combined mode if the tag's orientation is not known. In combined mode, horizontal polarization and then vertical polarization is used for each read/write attempt. This achieves the same results as when circular polarization is used. The duration of the read/write operation is extended in combined mode.

CD Transmission Channels

Programmable frequency list frequency access method:

This parameter sets the number and sequence of transmission channels or reads out the number and sequence of transmission channels.

Frequency hopping spread spectrum frequency access method:

This parameter reads out the number and sequence of transmission channels for the frequency hopping spread spectrum.

ParamTyp:	CD
Default:	Depends on the country identifier set, see chapter 3.3.
Value range:	Depends on the country identifier set, see chapter 3.3.

Example:

WP1UCD.00.04.07.0A.04.0D defines the sequence 7, 10, 4, and 13 as the permitted transmission channels

WP1UCD.00.01.0A allows the read/write head to use only transmission channel 10

RP1UCD.00.00 reads out the sequence of permitted transmission channels



Tip

If you have parameterized several transmission channels with the parameter CD, the read/write head executes each write or read command on all defined transmission channels sequentially according to the defined sequence. If several additional transmission power values are parameterized (), all set transmission powers are executed on each transmission channel for each read or write command. See chapter 6.2.

Number of Unsuccessful Attempts until Status 5 "Enhanced Status 5" E5

This parameter sets the number of unsuccessful read/write attempts until a status 5 is output for an enhanced command, or outputs the number.

Status 0 and status A depend on this parameter, and are output immediately.

ParamTyp:	E5
Default:	E5 = 5
Value range:	0 ... 252

Example:

WP1UE5.00.01.05 sets the number to 5 unsuccessful read/write attempts until a status 5 is output

RP1UE5.00.00 outputs the number

If the number of read/write attempts is reduced:

- ⊕ Faster response time in enhanced mode.
- ⊖ Status 5 messages in the event of unstable tag reading.

Read Out Filter Mask "Filter List" FL

Parameter FL contains the current configuration of the filter masks as set during execution of command FI. The output format corresponds to the data input format of command FI without the filter number. The parameter can only be read, but not set.

ParamTyp: FL
Value range: 0 ... 2

Example:

RP1UFL.00.01.02 outputs the current configuration of filter 2

Response: <Status><ChanNo><MemBank><Negate><LogicalOperation>0<StartAddress><MaskLength><MaskData><CHCK><ETX>

Output Additional Information, "Information" IF

Parameter IF allows you to output additional information providing that the reading was successful and the multiframe protocol is activated. See "Protocol Mode QV" on page 54. The additional information is the RSSI value of the reading, the transmission channel used, and transmitting power of this reading.

ParamTyp: IF
Default: IF = 0
Value range: 0, 1

Example:

WP1UIF.00.01.01 prompts the read/write head to output additional information after each successful reading.

RP1UIF.00.00 outputs the value of parameter IF.

The additional information is output in the following format:
B<ChanNo> <InfoTyp> <RSSI> <TxChannel> <TxPower>

To distinguish the additional information from the standard outputs, the output begins with the status B as the first ASCII character, followed by the IDENT*Control* channel. This is followed by the <InfoTyp>, which indicates that this is a type .01 information frame. The output ends with the RSSI value (1 byte), the transmission channel used (1 byte), and the power used (2 bytes). The RSSI value is between 0 (= low) and 100 (= high).

Meaning of the bytes in response .42.31.01.1A.0D.00.14

.42	=	Status B _{ASCII} to identify the additional information
.31	=	1 _{ASCII} , IDENT <i>Control</i> channel 1
.01	=	The information type
.1A	=	26 _{dec} , RSSI value
.0D	=	13 _{dec} , tag access to transmission channel 13
.00.14	=	20 _{dec} , transmission power 20 mW

Memory Module for Tag Accesses to the "Memory Bank" MB

This parameter specifies the bank accessed by the read/write commands SR, ER, SW, and EW. See chapter 3.2.3.

ParamTyp:	MB
Default:	MB = .03 = User Memory
Value range:	.00 = reserved (password area) .01 = Ull/EPC .02 = TID .03 = User Memory

Example:

WP1UMB.00.01.03 sets the bank to User Memory

Retrieve Additional Information MD

This parameter allows you to retrieve information about the last successful tag access. This returns the RSSI value with a length of 1 byte, the transmission channel used with a length of 1 byte, and the transmitting power with a length of 2 bytes. The RSSI value may be between 0 (= low) and 100 (= high).

Parameter MD allows the same data to be accessed in the single-frame protocol as is available in the multiframe protocol with parameter IF. See "Protocol Mode QV" on page 54 and see "Output Additional Information, "Information" IF" on page 51.

ParamTyp:	MD
-----------	----

Example:

RP1UMD.00.01.01 returns the response .30.01.13.04.00.32

Explanation of the response:

<Status> = 0

<ChanNo> = 1

<RSSI> = . 13 = 19_{dec}

<TXChannel> = . 04

<TXPower> = .00.32 = 50_{dec} mW

Measurement of Reflected Transmitting Power "Measure Reflection" MF

This parameter measures the reflected transmitting power of the antenna and the environment.

The results are output as one byte per transmission channel. The transmission channels are dependent on the country-specific settings, .

The parameter is not output for the "combined" antenna polarization.

To obtain the reflected power in dBm, subtract the value 100 from the return value in decimal notation.

ParamTyp:	MF
Value range:	-18 .. +21 dBm ¹

¹ 0 or 255 is returned for values outside the value range

Example:

If the country identifier RC = 01 (= 4 channels), RP1UMF.00.00 returns the response 01.63.64.67.65

Explanation of the response:

<Status> = 0

<ChanNo> = 1

<PCh04> = .63 = 99_{dec} results in 99 - 100 = -1 dBm

<PCh07> = .64 = 100_{dec} results in 100 - 100 = 0 dBm

<PCh10> = .67 = 103_{dec} results in 103 - 100 = +3 dBm

<PCh13> = .65 = 101_{dec} results in 101 - 100 = +1 dBm

Number of Channels NC

Frequency Access Method **Frequency hopping spread spectrum**:

Parameter NC indicates the number of channels on which a write or read attempt is performed. If the value 4 is set, the read/write head attempts to read the tag on 4 different frequencies when a read command is given. The parameter can be read and written.

Frequency Access Method **Parameterizable frequency list**:

The parameter can be read only. The parameter specifies the number of transmission channels that are set with parameter CD.

ParamTyp:	NC
Default:	NC = 4
Value range:	1 ... 50

Example:

WP1UNC.00.01.02 allows two channels for a read attempt.

RP1UNC.00.00 reads out the number of channels set.

Search Algorithm Cancellation Criteria "number of tags to find" NT

Parameter NT specifies the number of tags in the measurement range that the read/write head searches for. Each command is repeated in accordance with the parameters Transmission Power (PT), Transmission Channel (CD) or Number of Channels (NC), and Number of Attempts (TA) (see chapter 6.2). If the number of tags found during the repeat operations reaches or exceeds the NT value, all further runs are canceled. The command is canceled, and the data is output.

If the number of tags is set to 255 (= .FF), the function is deactivated. This parameter does not affect "enhanced" commands, but only "single" commands.

ParamTyp:	NT
Default:	NT = 255
Value range:	0 ... 254, 255 = off

Example:

The value WP1UNT.00.01.05 sets the number of tags in the measurement range for which the read/write head searches to 5.

RP1UNT.00.00 outputs the set value.

Transmission Power "Power Transmit" PT

This parameter sets the transmission power in mW or reads out the transmission power set.

ParamTyp:	PT
Default:	Depends on the country identifier set, see chapter 3.3.
Value range:	Depends on the country identifier set, see chapter 3.3.

Example:

WP1UPT.00.02.00.32 sets the transmission power to 50 mW

RP1UPT.00.00 reads out the transmission power currently set

- ⊕ Higher detection range if you increase the transmission power.
- ⊖ Possible excessive detection ranges if you increase the transmission power.
- ⊖ Lower detection range in reflective environments if you increase the transmission power.
- ⊖ Adjacent read/write heads might be affected due to increased detection range.



Note

You can operate the IUH-F192-V1-* read/write head only with internally specified transmission power. You can use the command WP1UPT.00.02.xx.xx in the software to enter any transmission power within the specified range of values. The read/write head automatically sets the transmission power to the next lowest value available. Any entries outside the specified value range are returned as errors. Command RP1UPT.00.00 allows you to read out the power value that is currently set.



Tip

You can parameterize the read/write head with several transmission power values:

Command WP1UPT.00.06.00.14.00.32.00.64 sets three transmission power values for 20 mW, 50 mW, and 100 mW. Each read and write command is executed in succession for all three transmission power values. If one or more tags are found and successfully read/written for the first transmission power, the command is still executed with all other transmission powers to reach any other tags that may be available.

You can specify a maximum of ten transmission power values. If several additional transmission channels are selected (), all set powers are executed on each transmission channel for each read or write command. See chapter 6.2.

Protocol Mode QV

Parameter QV toggles the output protocol between single frame and multiframe.

In single-frame protocol, the output corresponds to the Pepperl+Fuchs standard in LF and HF systems. If there is more than one tag in the measurement range, status A is output as a warning.

In the multiframe protocol, each tag that responded is output. An output is then issued which begins with status F, contains the number of responses, and completes the full command output.

ParamTyp:	QV
Default:	QV = .4D
Value range:	.53 = S for single-frame protocol .4D = M for multiframe protocol

Example:

WP1UQV.00.01.4D sets the protocol to multiframe.

RP1UQV.00.00 outputs the set protocol mode.

If QV = M, the following responses are made to a single read command (SR):

```
Response: 0<ChanNo><Luii><UII1><Ldata><data><CHCK><ETX>
          0<ChanNo><Luii><UII2><Ldata><data><CHCK><ETX>
          0<ChanNo><Luii><UII3><Ldata><data><CHCK><ETX>
          F<ChanNo>0003<CHCK><ETX>
```

One read command was executed to which three tags responded. For each tag, the status, the IDENTControl channel, the length of the Ull, the Ull, the length of the data, and the read data are output. Then an output is issued with status F, the IDENTControl channel, and the number of tags that responded.

<Luii> = Length of <Ull> in bytes, 2 bytes

<Ldata> = Length of <data> in bytes, 2 bytes

Responses Depending on Protocol Mode QV

Command	Parameter QV	
	Single-frame protocol	Multiframe protocol
	Responses	
SS	No tag: 5<ChanNo> One tag: 0<ChanNo><Ull> Two tags: A<ChanNo>	No tag: F<ChanNo>0000 Two tags: 0<ChanNo><Luii><Ull1> 0<ChanNo><Luii><Ull2> F<ChanNo>0002
SR, #SR SF	No tag: 5<ChanNo> One tag: 0<ChanNo><data> Two tags: A<ChanNo>	No tag: F<ChanNo>0000 Two tags: 0<ChanNo><Luii><Ull1><Ldata><data> 0<ChanNo><Luii><Ull2><Ldata><data> F<ChanNo>0002
SW, #SW	No tag: 5<ChanNo> One tag: 0<ChanNo> Two tags: A<ChanNo>	No tag: F<ChanNo>0000 Two tags: 0<ChanNo><Luii><Ull1> 0<ChanNo><Luii><Ull2> F<ChanNo>0002
ES	No tag: 5<ChanNo> One tag added: 0<ChanNo><Ull> One tag added: A<ChanNo> One tag removed: 0<ChanNo><Ull> All tags removed: 5<ChanNo>	No tag: 5<ChanNo> Two tags added: 0<ChanNo><Luii><Ull1> 0<ChanNo><Luii><Ull2> Tag 1 removed: 5<ChanNo><Luii><Ull1> Tag 3 added: 0<ChanNo><Luii><Ull3> Tag 4 added (Ull same as tag 2): A<ChanNo><Luii><Ull2> All tags removed: 5<ChanNo><Luii><Ull2> 5<ChanNo><Luii><Ull3> 5<ChanNo><Luii><Ull2>
SP	No tag: 5<ChanNo> One tag: 0<ChanNo> Two tags: A<ChanNo>	No tag: F<ChanNo>0000 One tag: 0<ChanNo><NUL><Luii><Ull1> F<ChanNo>0001 Two tags: 0<ChanNo><NUL><Luii><Ull1> A<ChanNo><NUL><Luii><Ull2> F<ChanNo>0002

Table 6.2 <CHCK><ETX> omitted at the end of each response due to space requirements

Q Value QW

In accordance with EPC Gen 2 (ISO/IEC 18000-63), the slotted ALOHA principle is used for anticollision. The number of time slots is defined as 2^Q . The parameter QW defines the Q value. As a guide, the number of time slots should roughly correspond to the number of expected tags in the measurement range.

ParamTyp:	QW
Default:	QW = 2
Value range:	0 ... 7

Example:

WP1UQW.00.01.04 sets the Q value to 4. The read/write head therefore works with $2^4 = 16$ time slots.

RP1UQW.00.00 outputs the set Q value.

Country Identifier, "Region Code" RC

Parameter RC sets a country identifier or reads out the current country identifier.

The country identifier consists of two bytes:

- 1. Byte = 00
You can change the country identifier
- 1. Byte = 80
You cannot change the country identifier

The country identifier can be set to write-protected by the manufacturer only. The first byte is then set to 80. The second byte defines the country identifier. For all the available country identifiers, see chapter 5.2, and for the corresponding technical details, see chapter 3.3.

ParamTyp:	RC
Default setting:	.00.00 (green LED flashes)
Value range:	See chapter 5.2

Note

Once you have set the country identifier, the read/write head automatically resets all other parameters to their respective default values. When programming or configuring parameters manually, always set the correct country identifier before changing any other parameters.

Note

The country identifier remains unchanged when the default status is restored.

Note

The IUH-F192-V1-FR2-02 is supplied ex-works with the country identifier "02" for the USA, Canada, and Mexico. Due to legal regulations, you cannot change this country identifier in the IUH-F192-V1-FR2-02.

Example:

WP1URC.00.02.00.03 sets the country identifier to China.

RP1URC.00.00 reads out the country identifier set.

The serial response .30.31.00.01 indicates the country identifier for Europe, which you can modify.

The serial response .30.31.80.02 indicates the country identifier for the IUH-F192-V1-FR2-02, which is set by the manufacturer. You cannot change this country identifier.

Reset to Default, RD

This parameter returns all settings of the read/write head to the default configuration.

ParamTyp: RD

Example:
WP1URD.00.00

Default Value Parameters

Abbreviation	Parameter	Default value
AP	Antenna Polarization AP	Combined mode (C)
CD	Transmission Channels	Depending on the country-specific settings,
E5	Number of unsuccessful attempts up to Status 5	5
FL	Read Out Filter Mask	No filter set (0)
IF	Output Additional Information	Off (0)
MB	Memory Bank	User Memory (3)
MD	Retrieve Additional Information MD	Not applicable
MF	Measurement of Reflected Transmission Power	Not applicable
NC	Number of Channels	Depending on the country-specific settings,
NT	Search Algorithm Cancellation Criteria	Off (255)
PT	Power Transmit	Depending on the country-specific settings,
QV	Protocol Mode QV	Multiframe Protocol (M)
QW	Q Value	2
RC	Country Identifier, "Region Code"	Not applicable
RD	Reset to Default	Not applicable
SM	Transmission Pauses in "Sensing Mode"	0
TA	Number of Attempts, "Tries Allowed" TA	2

Transmission Pauses in "Sensing Mode" SM

The parameter SM defines a pause time in milliseconds. This pause time is executed once all runs are complete.

This parameter is especially useful for continuous operation with "enhanced" commands (see chapter 6.4). If you specify transmission pauses, you can operate the read/write head at higher ambient temperatures.

ParamTyp:	SM
Default:	SM = 100 ms ¹ SM = 0 ms ²
Value range:	100 ms ... 65,535 ms, 2 bytes ³ 0 ms ... 65,535 ms, 2 bytes ⁴

1. For all FR1 read/write heads

2. For all FR2 read/write heads

3. For all FR1 read/write heads

4. For all FR2 read/write heads

Example:

WP1USM.00.02.27.10 sets the pause time to 10,000 ms = 10 seconds.

RP1USM.00.00 reads out the pause time.

Number of Attempts "Tries Allowed" TA

This parameter sets the permitted number of read or write attempts, or reads out the permitted number of attempts.

ParamTyp:	TA
Default:	TA = 1
Value range:	1 ... 255

Example:

WP1UTA.00.01.01 permits precisely one attempt (= no repeats)

WP1UTA.00.01.03 permits three attempts

RP1UTA.00.00 reads out the permitted number of attempts

If the permitted number of read or write attempts between the read/write head and the tag is increased, this results in:

⊕ More reliable reading and writing.

⊖ Increased response time.

6.7 Error/Status Messages

Status	Description
0	The command was executed correctly.
1	Reserved
2	Switch-on message, reset was executed.
3	Reserved
4	The command is incorrect or incomplete. The parameter is not in the valid area.
5	No read/write tag in the measurement range.
6	Hardware error, e.g., error during self-test or read/write head defective.
7	Internal device error.
8	Reserved
9	The parameterized tag type is not compatible with the connected read head.
A	Singleframe protocol: there are multiple tags in the measurement range (IUH*). Multiframe protocol: There are multiple tags in the measurement range that have the same UII/EPC (IUH*).
B	Indicates the output of additional information (see "Output Additional Information, "Information" IF" on page 51).
C	Reserved
D	Reserved
E	Internal buffer overflow; execute reset.
F	Indicates the end of an output in the multiframe protocol (see "Protocol Mode QV" on page 54).

7 Service and Maintenance

The device is designed and constructed to function stable over long periods of time. For this reason, regular cleaning or maintenance is unnecessary.

8 Troubleshooting

Problem	Solution
Interference from several read/write heads in the direct vicinity	<ul style="list-style-type: none">• Change the setting of the transmission channels• Reduce the transmission power
Status A message	<ul style="list-style-type: none">• Check whether there are multiple tags in the detection range: Remove the tag from the detection range by placing the tag in a sealed metal container Repeat the read or write operation• Use filter commands• Determine whether multiple tags have the same UII/EPC
Device not responding, green LED flashing	<ul style="list-style-type: none">• Set the correct country identifier. See chapter 5.2 and see chapter 3.3.

9 Appendix

9.1 Dimensions

IUH-F192-V1-*

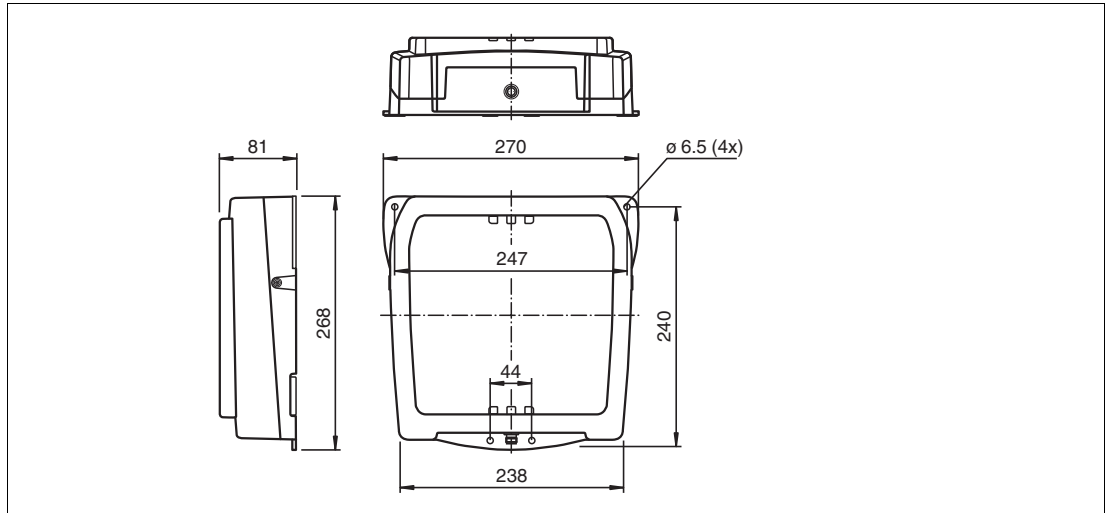

Figure 9.1

9.2 ASCII table

hex	dec	ASCII	hex	dec	ASCII	hex	dec	ASCII	hex	dec	ASCII
00	0	NUL	20	32	Space	40	64	@	60	96	'
01	1	SOH	21	33	!	41	65	A	61	97	a
02	2	STX	22	34	"	42	66	B	62	98	b
03	3	ETX	23	35	#	43	67	C	63	99	c
04	4	EOT	24	36	\$	44	68	D	64	100	d
05	5	ENQ	25	37	%	45	69	E	65	101	e
06	6	ACK	26	38	&	46	70	F	66	102	f
07	7	BEL	27	39	'	47	71	G	67	103	g
08	8	BS	28	40	(48	72	H	68	104	h
09	9	HT	29	41)	49	73	I	69	105	i
0A	10	LF	2A	42	*	4A	74	J	6A	106	j
0B	11	VT	2B	43	+	4B	75	K	6B	107	k
0C	12	FF	2C	44	,	4C	76	L	6C	108	l
0D	13	CR	2D	45	-	4D	77	M	6D	109	m
0E	14	SO	2E	46	.	4E	78	N	6E	110	n
0F	15	SI	2F	47	/	4F	79	O	6F	111	o
10	16	DLE	30	48	0	50	80	P	70	112	p
11	17	DC1	31	49	1	51	81	Q	71	113	q
12	18	DC2	32	50	2	52	82	R	72	114	r
13	19	DC3	33	51	3	53	83	S	73	115	s
14	20	DC4	34	52	4	54	84	T	74	116	t
15	21	NAK	35	53	5	55	85	U	75	117	u
16	22	SYN	36	54	6	56	86	V	76	118	v
17	23	ETB	37	55	7	57	87	W	77	119	w

hex	dec	ASCII	hex	dec	ASCII	hex	dec	ASCII	hex	dec	ASCII
18	24	CAN	38	56	8	58	88	X	78	120	x
19	25	EM	39	57	9	59	89	Y	79	121	y
1A	26	SUB	3A	58	:	5A	90	Z	7A	122	z
1B	27	ESC	3B	59	;	5B	91	[7B	123	{
1C	28	FS	3C	60	<	5C	92	\	7C	124	
1D	29	GS	3D	61	=	5D	93]	7D	125	}
1E	30	RS	3E	62	>	5E	94	^	7E	126	~
1F	31	US	3F	63	?	5F	95	_	7F	127	DEL

9.3 Detection Range

The read/write head has a typical detection range of around 1 meter; this range is determined by the tag used and can be adjusted by selecting the transmission power. Other influencing factors include the setup and installation of the specific application, interference from any materials present (in particular metal), and the ambient conditions. The read and write distances for the relevant tag, which are detailed separately, have been established in a test laboratory under ideal conditions. For this reason, the combination of read/write head and tag must be tested for the intended application under real conditions.

Please note the distance tables. The distance tables and additional information regarding your product can be found at <http://www.pepperl-fuchs.com>. Simply enter the product name or model number in the **Search** box and then click the **Search** key.

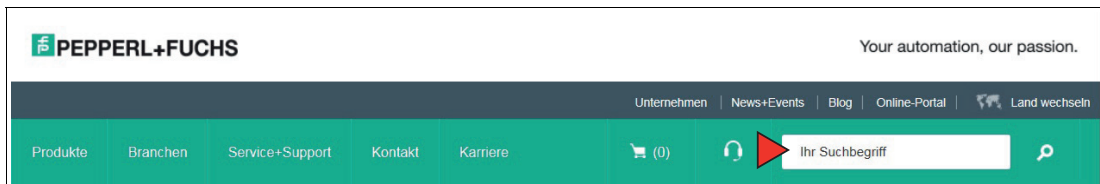

Select your product from the list of search results. Click on the information you require in the product information list, e.g., **Technical documents**.



A list of all available documents is displayed.

Antenna Diagram

The antenna diagrams show the electric field strength in the far field depending on the direction. The front of the read/write head points towards 0°.

IUH-F192-V1-FR1 (865 MHz... 868 MHz) and IUH-F192-V1-FR2 (902 MHz... 928 MHz)

Horizontal Cut¹

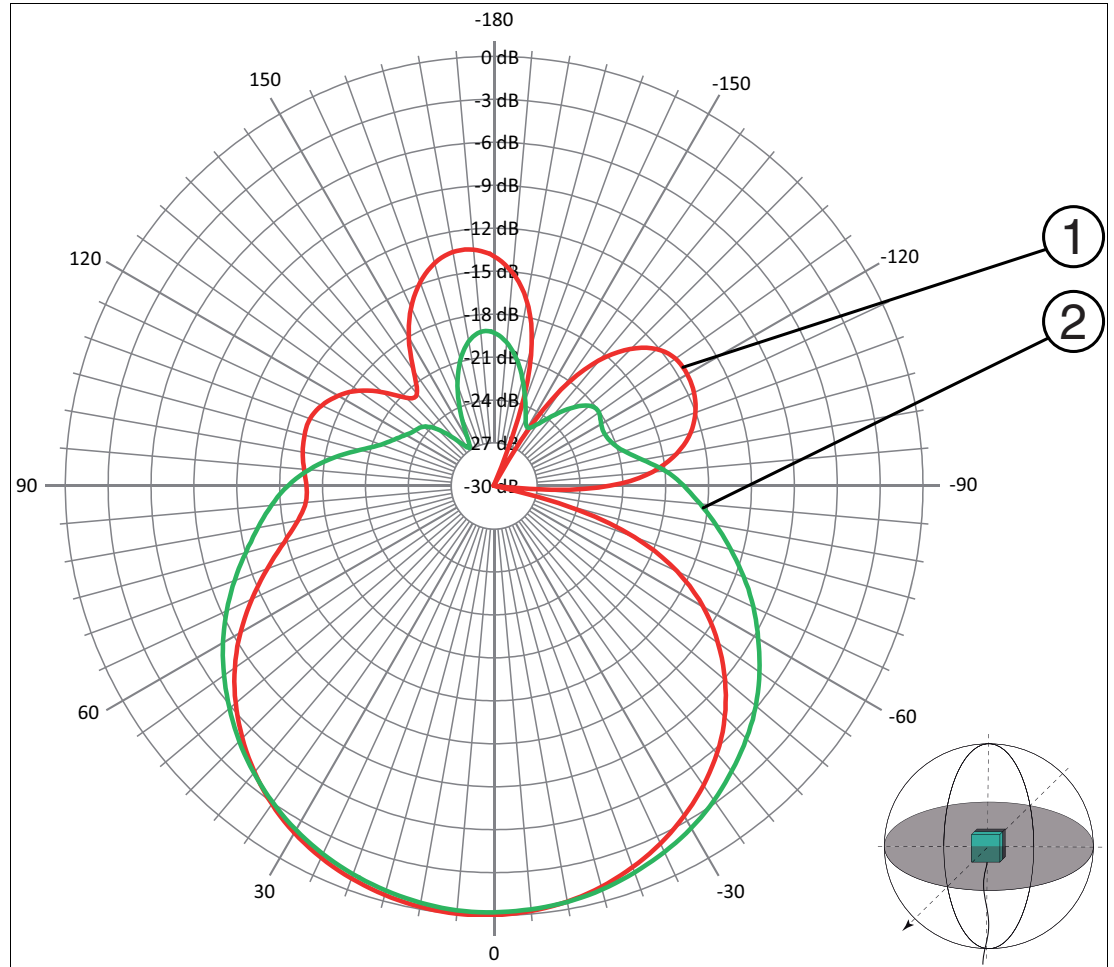

1. Read/write head points towards 0°

Figure 9.2 1 - Horizontal polarization
 2 - Vertical polarization

Vertical Cut¹

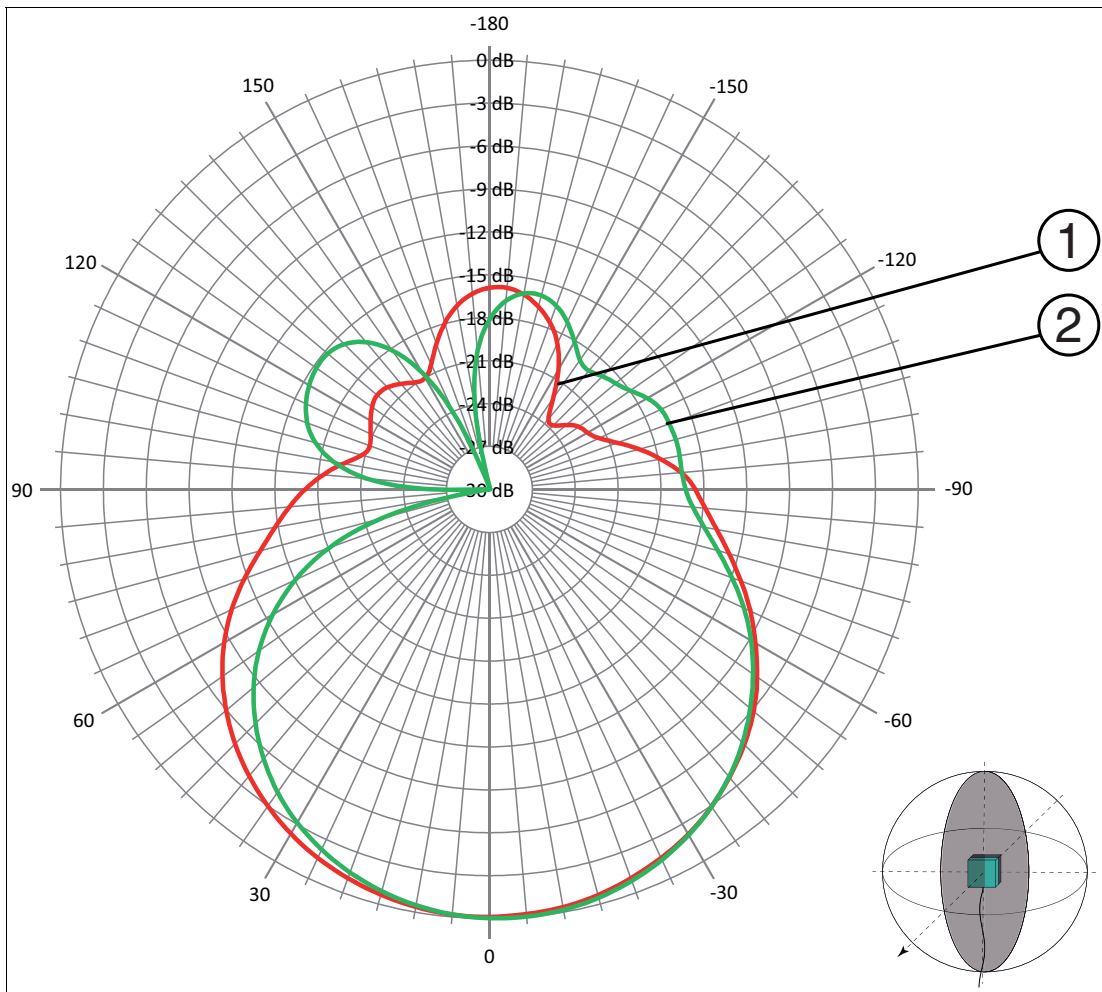

1. Read/write head points towards 0°

Figure 9.3 1 - Horizontal polarization
 2 - Vertical polarization

Your automation, our passion.

Explosion Protection

- Intrinsic Safety Barriers
- Signal Conditioners
- FieldConnex® Fieldbus
- Remote I/O Systems
- Electrical Ex Equipment
- Purge and Pressurization
- Industrial HMI
- Mobile Computing and Communications
- HART Interface Solutions
- Surge Protection
- Wireless Solutions
- Level Measurement

Industrial Sensors

- Proximity Sensors
- Photoelectric Sensors
- Industrial Vision
- Ultrasonic Sensors
- Rotary Encoders
- Positioning Systems
- Inclination and Acceleration Sensors
- Fieldbus Modules
- AS-Interface
- Identification Systems
- Displays and Signal Processing
- Connectivity

Pepperl+Fuchs Quality

Download our latest policy here:

www.pepperl-fuchs.com/quality

