

MANUAL

Absolute Rotary Encoder with PROFIBUS Interface





With regard to the supply of products, the current issue of the following document is applicable: The General Terms of Delivery for Products and Services of the Electrical Industry, published by the Central Association of the Electrical Industry (Zentralverband Elektrotechnik und Elektroindustrie (ZVEI) e.V.) in its most recent version as well as the supplementary clause: "Expanded reservation of proprietorship"

1	Introduction.....	5
1.1	Content of this Document	5
1.2	Target Group, Personnel.....	5
1.3	Symbols Used	5
2	Declaration of Conformity.....	7
2.1	CE Conformity	7
3	Sicherheit	8
3.1	Symbols Relevant to Safety	8
3.2	Intended Use	8
3.3	General Safety Instructions.....	8
4	General Information on System Integration	9
4.1	Using This Manual	9
4.2	Absolute Rotary Encoders	9
4.3	Communication via PROFIBUS.....	9
4.3.1	General Information on Communication via PROFIBUS.....	9
4.3.2	Project Planning Using Device Description	10
4.3.3	PROFIBUS Address	10
5	Installation.....	11
5.1	Instructions for Mechanical and Electrical Installation.....	11
5.2	Electrical Connection	12
5.3	Configuring Subscriber Addresses	14
5.4	Configuring/Connecting the Terminator	15
5.5	LED Indicators	15
6	Device Profiles for PROFIBUS.....	17
6.1	Device Profile in Accordance with PROFIBUS Encoder Profile	17
6.2	Manufacturer-Specific Device Profile	20

7	Configuring the Rotary Encoder Using Step7	24
7.1	Introduction.....	24
7.2	Installing the GSD File	24
7.3	Select the Rotary Encoder and Assign the DP Address.....	25
7.4	Select the Device Class.	27
7.5	Adjusting the Rotary Encoder Parameters in Accordance with Device Class 1	28
7.6	Adjusting the Rotary Encoder Parameters in Accordance with Device Class 2	31
7.7	Adjusting the Rotary Encoder Parameters in Accordance with Device Class P+F V2.1	36
7.8	Adjusting the Rotary Encoder Parameters in Accordance with Device Class P+F V2.2	42
7.9	Download to PLC Module	48
8	Commissioning Mode	50
8.1	Introduction.....	50
8.2	Setting the Counting Direction.....	50
8.3	Setting the Step Number via Teach-In	52
8.4	Setting the Preset Value.....	58
9	Diagnostic Messages	62
9.1	Overview.....	62
9.2	Displaying Diagnostic Messages with the Project Planning Tool .	63
9.3	Supported Diagnostic Messages.....	64

1 Introduction

1.1 Content of this Document

This document contains information required to use the product in the relevant phases of the product life cycle. This may include the following:

- Product identification
- Delivery, transport, and storage
- Assembly and installation
- Commissioning and operation
- Maintenance and repair
- Troubleshooting
- Dismounting
- Disposal

The documentation comprises the following parts:

- Present document
- Datasheet

In addition, the documentation may comprise the following parts, if applicable:

- EC-Type Examination Certificate
- EC Declaration of Conformity
- Attestation of conformity
- Certificates
- Control drawings
- Other documents

1.2 Target Group, Personnel

Responsibility for planning, assembly, commissioning, operation, maintenance, and dismounting lies with the plant operator.

Only appropriately trained and qualified personnel may carry out mounting, installation, commissioning, operation, maintenance, and dismounting of the product. The personnel must have read and understood the instruction manual and the further documentation.

Prior to using the product make yourself familiar with it. Read the document carefully.

1.3 Symbols Used

This document contains symbols for the identification of warning messages and of informative messages.

Warning Messages

You will find warning messages, whenever dangers may arise from your actions. It is mandatory that you observe these warning messages for your personal safety and in order to avoid property damage.

Depending on the risk level, the warning messages are displayed in descending order as follows:



Danger!

This symbol indicates an imminent danger.

Non-observance will result in personal injury or death.



Warning!

This symbol indicates a possible fault or danger.

Non-observance may cause personal injury or serious property damage.



Caution!

This symbol indicates a possible fault.

Non-observance could interrupt the device and any connected systems and plants, or result in their complete failure.

Informative Symbols



Note!

This symbol brings important information to your attention.



Action

This symbol indicates a paragraph with instructions. You are prompted to perform an action or a sequence of actions.



2 Declaration of Conformity

2.1 CE Conformity

This product was developed and manufactured under observance of the applicable European standards and guidelines.



Note!

A declaration of conformity can be requested from the manufacturer.

3 Safety

3.1 Symbols Relevant to Safety



Danger!

This symbol indicates an imminent danger.
Non-observance will result in personal injury or death.



Warning!

This symbol indicates a possible fault or danger.
Non-observance may cause personal injury or serious property damage.



Caution!

This symbol indicates a possible fault.
Non-observance could interrupt the device and any connected systems and plants, or result in their complete failure.

3.2 Intended Use

Absolute rotary encoders detect the rotation angle—and, in the case of a multiturn absolute rotary encoder, the revolutions of the rotary encoder shaft—with high precision and resolution. The absolute position value derived from this is provided by the rotary encoder via the PROFIBUS interface in accordance with the standard from the "PROFIBUS & PROFINET International (PI)" organization. The rotary encoder is to be integrated into a PROFIBUS network and should be used only in this way. Typical applications include positioning tasks and length measurement, for example, for cranes, construction machinery, elevators, and packaging machines.

Read through these instructions thoroughly. Familiarize yourself with the device before installing, mounting, or operating.

Always operate the device as described in these instructions to ensure that the device and connected systems function correctly. The protection of operating personnel and plant is only guaranteed if the device is operated in accordance with its intended use.

3.3 General Safety Instructions

Responsibility for planning, assembly, commissioning, operation, maintenance, and dismantling lies with the plant operator.

Installation and commissioning of all devices may be performed only by trained and qualified personnel.

User modification and or repair are dangerous and will void the warranty and exclude the manufacturer from any liability. If serious faults occur, stop using the device. Secure the device against inadvertent operation. In the event of repairs, return the device to your local Pepperl+Fuchs representative or sales office.



Note!

Disposal

Electronic waste is hazardous waste. When disposing of the equipment, observe the current statutory requirements in the respective country of use, as well as local regulations.

4 General Information on System Integration

4.1 Using This Manual

This manual describes how Pepperl+Fuchs absolute rotary encoders equipped with a PROFIBUS interface are integrated into a PROFIBUS network.

The manual is valid for the following absolute rotary encoder types:

- ENA58IL-...B06...
- Pxx58x...
- PVx78E...

The descriptions for the following topic areas cover all the important aspects for a simple PROFIBUS integration:

- Integration into the PROFIBUS master interface connection
- Setting the physical parameters
- Activating PROFIBUS communication
- Communication with the absolute rotary encoder



Note!

Further information on technical data, mechanical data, connection layouts, and available connection lines for the relevant absolute rotary encoder types "ENA58IL-...B06...", "Pxx58x...", and "PVx78E" can be found in the corresponding datasheet.

4.2 Absolute Rotary Encoders

Absolute rotary encoders output a uniquely coded numerical value at each shaft position. Depending on the design type, the measured value is recorded via the optical scanning of a transparent code disc (Pxx58x..., PVx78E...) or via a magnetic sensing principle (ENA58IL-...B06...).

The maximum steps per revolution is 65,536 steps (16 bits). The multiturn version can detect up to 16,384 revolutions (14 bits). As such, the highest possible resolution is 30 bit.

4.3 Communication via PROFIBUS

4.3.1 General Information on Communication via PROFIBUS

PROFIBUS is a manufacturer-independent, open fieldbus standard defined by the EN 50170 and EN 50254 international standards. Three PROFIBUS variants exist: DP, FMS and PA. Absolute rotary encoders support the DP (decentralized peripheral) variant for controlling sensors and actuators through a central controller. This variant is designed for transfer rates of up to 12 Mbit/s.

The device profile in accordance with "PROFIBUS profile for encoders" provides a manufacturer-independent and binding specification of the interface for rotary encoders. This profile specifies the functions used and how they must be used. In addition to device profile classes 1 and 2 from PROFIBUS-Nutzerorganisation e. V., absolute rotary encoders from Pepperl+Fuchs support manufacturer-specific device profiles with additional functions.

The "PROFIBUS Encoder Profile" device profile can be ordered from PROFIBUS-Nutzerorganisation e. V. in Karlsruhe with order number 3.062. Further information on PROFIBUS (functionality, manufacturers, products) and on standards and profiles is also available here (see <http://www.profibus.com>).

PROFIBUS-Nutzerorganisation e. V.
Haid-und-Neu-Strasse 7
76131 Karlsruhe
Germany

4.3.2 Project Planning Using Device Description

As with PROFIBUS DP, a field device is integrated into the project planning tool by way of a device description. The properties of the field device are described in the device description GSD (Generic Station Description) file. The GSD file contains the field device data (technical features and information for communication) that you need to operate the device in a PROFIBUS network. To enable you to configure the absolute rotary encoder in accordance with application requirements, you will need to load the GSD file corresponding to your absolute rotary encoder in the project planning tool.

Downloading the GSD File

You can find the relevant GSD file in the **Software** section of the product detail page for the device.

To access the product detail page for the device, go to <http://www.pepperl-fuchs.com> and type information about the device (e.g., the product description or the item number) into the search function.

4.3.3 PROFIBUS Address

Every PROFIBUS subscriber must have a unique address for communication within the network. PROFIBUS addresses can be selected in the range 0 ... 127 and are coded in one byte. Master station addresses are in the low address range, with slave subscriber addresses following these addresses. Certain addresses are reserved for special applications.

For absolute rotary encoders, you can set an address from the address range 1 ... 99 via the rotary switch (please see chapter "Installation").

PROFIBUS Addressing Concept

Address	Application
0	Typically reserved for diagnostic purposes, such as. programming units
1 ... n	The addresses of master subscribers should begin at the lowest addresses. An individual master therefore has the address 1. Additional master subscribers have the addresses 2, 3, etc.
n ... 125	A maximum of 124 addresses is therefore available for the slave subscribers in a PROFIBUS network with a master.
126	Reserved as factory setting for stations with addresses that can be configured via the PROFIBUS.
127	Reserved as "broadcast address" for addressing to all nodes.

Table 4.1

5 Installation

5.1 Instructions for Mechanical and Electrical Installation



Note!

Further installation-relevant information on technical data, mechanical data, and available connection cables for the relevant absolute rotary encoder types "ENA58IL-...B06...", "Pxx58x...", and "PVx78E..." can be found in the corresponding datasheet.

Please observe the following instructions to ensure safe operation of the absolute rotary encoder:



Warning!

Work must only be performed by trained and qualified personnel.

Commissioning and operation of this electrical equipment must only be performed by trained and qualified personnel. This means individuals who are qualified to commission (in accordance with safety technology), connect to ground, and label devices, systems, and circuits.



Warning!

Only perform work when the system is in a de-energized state.

De-energize your device before performing work on the electrical connections. Short circuits, voltage peaks, and similar events can lead to faults and undefined statuses. This presents a significant risk of personal injury and property damage.



Warning!

Check electrical connections before switching on the system.

Check all electrical connections before switching on the system. Incorrect connections present a significant risk of personal injury and property damage. Incorrect connections can lead to malfunctions.



Caution!

Do not remove the rotary encoder housing.

Do not remove the rotary encoder housing under any circumstances, as damage and contamination can occur as a result of taking improper action. It is, however, permitted to remove connector covers.



Caution!

Do not perform any electrical modifications.

It is not permitted to perform electrical modifications on the rotary encoders. If you open or modify the device yourself, not only are you endangering yourself and others but you will also void any warranty and absolve the manufacturer of any liability.



Caution!

Ensure that the data cable and power supply cable are physically separate.

Route the cordset of the rotary encoder so that it is a suitable distance away from power supply cables to avoid faults. Shielded cables must be used to ensure reliable data transfer. A perfect ground connection must also be ensured.

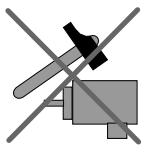

Do not allow the rotary encoder to fall or expose it to strong vibrations. The rotary encoder is a precision instrument.

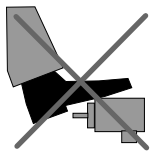

Rotary encoders from Pepperl+Fuchs are robust; however, they should nevertheless be protected against damage from the environment by taking appropriate protective measures. In particular, the devices must not be installed in a location where they could be misused as a handle or climbing aid.

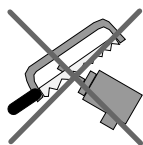

Do not make any alterations to the drive shaft or the housing of the rotary encoder.



Note!

For rotary encoders with solid shaft, the shaft must be connected to the drive shaft on the part to be measured via a suitable coupling. The coupling is required to protect the drive shaft on the rotary encoder against excessive levels of force, to compensate for shaft offset, and to reduce the impact of vibrations. Suitable couplings are available as accessories from Pepperl+Fuchs.

5.2 Electrical Connection

Depending on the version, absolute rotary encoders have a connection cover or connector. This means the PROFIBUS connection and line termination are performed in different ways.



Absolute Rotary Encoder with Connection Cover



Note!

The absolute rotary encoder is connected in the field environment via the connection cover for the PROFIBUS connection. The connection cover is connected to the rotary encoder via a 15-pin D-sub connector. A terminal block for electrical connection is located in the connection cover.

1. Loosen the screws of the connection cover on the rear of the device and remove the cover.
2. Route the bus and supply lines through the cable glands of the connection cover.
3. Connect the lines to the terminals of the connection cover according to the following table and figure.



Note!

The supply lines only need to be connected once (regardless of terminal). The additional bus is disconnected when the terminator is switched on.

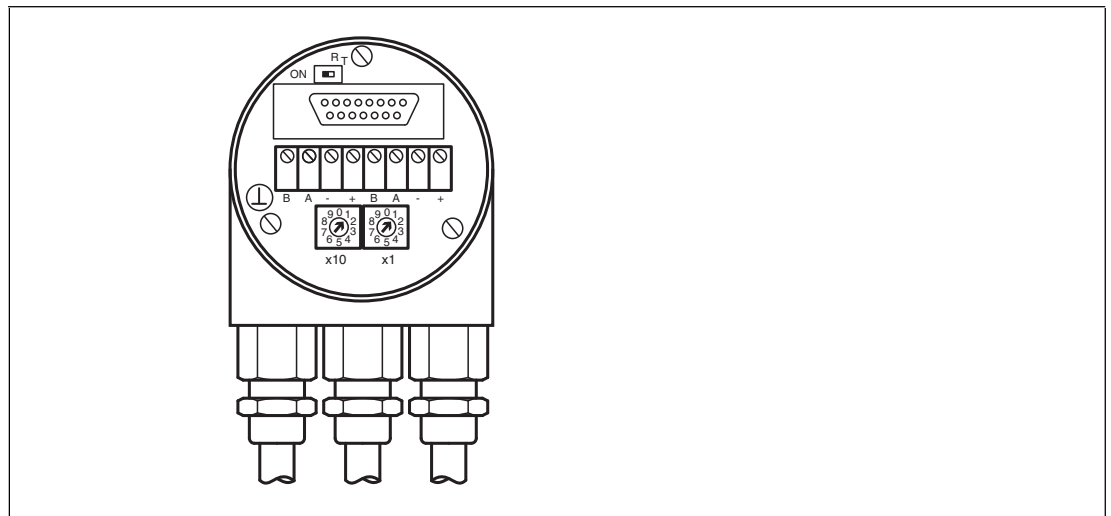

Figure 5.1

Terminal assignment

Terminal	Explanation
⊥	Ground connection for supply voltage
B (left)	Data line B (pair 1), bus in
A (left)	Data line A (pair 1), bus in
(-)	0 V
(+)	10 V ... 30 V
B (right)	Data line B (pair 2), bus out
A (right)	Data line A (pair 2), bus out
(-)	0 V
(+)	10 V ... 30 V

Table 5.1



Absolute Rotary Encoder with Connector



Note!

The absolute rotary encoder is connected in the field environment via the connector plug/socket for the PROFIBUS connection. No internal terminator is present in the absolute rotary encoder. The external 220-Ω ICZ-TR-V15B terminator (see datasheet) can be plugged into the device if necessary.

1. Connect the bus line and supply line to the absolute rotary encoder.
2. Connect the 220-Ω terminator to the "BUS Out" connector if necessary.

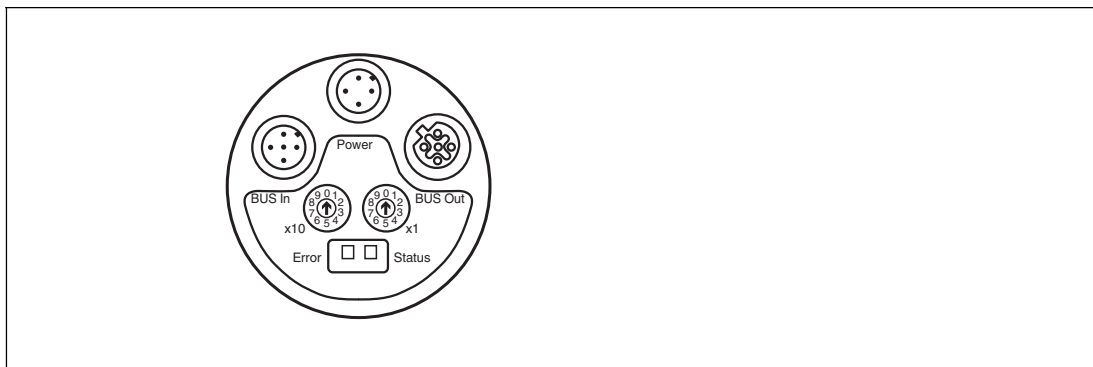
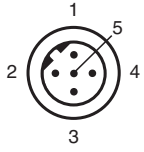
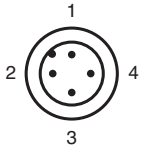
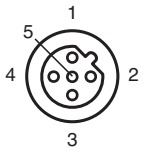

Figure 5.2

Connection	BUS In	Power	BUS Out
1	Not used	Operating voltage $+U_B$	+ 5 for terminator (2P5)
2	Data line A, bus IN	Not used	Data line A, bus OUT
3	Not used	0 V	GND for terminator (2M)
4	Data line B, bus IN	Not used	Data line B, bus OUT
5	Not used	-	Not used
			
Note	Connector plug, M12 x 1, 5-pin, B-coded	Connector plug, M12 x 1, 4-pin, A-coded	Connector socket, M12 x 1, 5-pin, B-coded

5.3 Configuring Subscriber Addresses

PROFIBUS subscriber addresses are configured via decimal rotary switches on the device. Dependent on the device version, the rotary switches are located on the rear of the device or in the connection cover.

Possible addresses are in the range between 1 and 99, and each address may only occur once in the system. The value (x 10 or x 1) is shown on the rotary switch.

The device address is read in when the power supply of the rotary encoder is switched on. Modification of the address by the master ("Set_Slave_Add") is not supported.

The figure below shows the rotary switches using the example of a device with PVM58 connection cover.

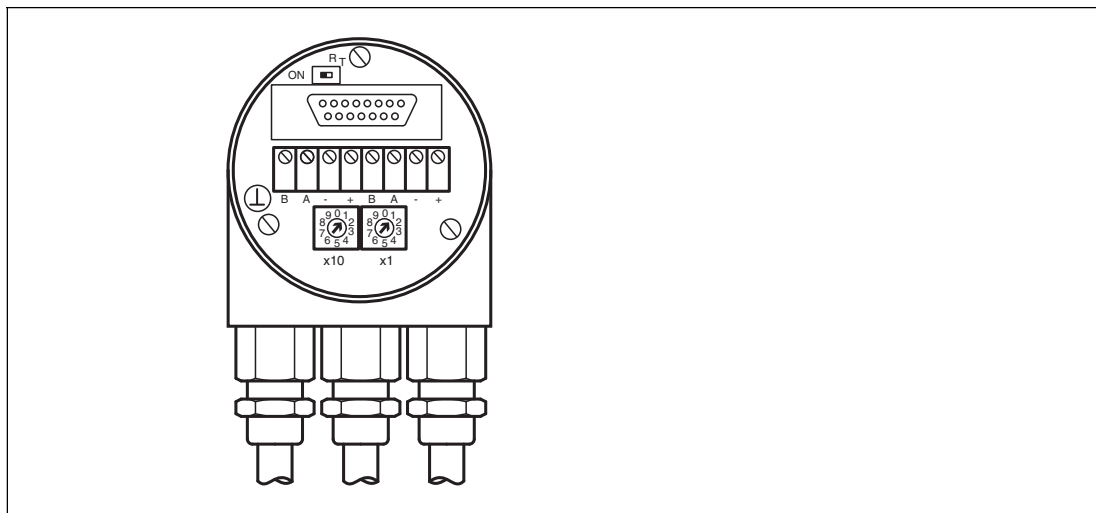

Figure 5.3

5.4 Configuring/Connecting the Terminator

To ensure a secure signal transfer, both ends within a PROFIBUS segment must be closed with a terminator. If the rotary encoder is installed in the segment as the final device, a terminator must be set. Depending on the construction of the rotary encoder, this can be connected either in the connection cover or, for the version with connector, via an external terminator.

Absolute Rotary Encoder with Connection Cover

If the rotary encoder is installed in the segment as the final device, the 220-Ω terminator integrated in the device must be connected. This is performed via the sliding switch in the connection cover.



Figure 5.4



Note!

The bus is only correctly connected if the rotary encoder is mounted on the connection cover. If the encoder needs to be replaced during operation, then the use of a separate active terminator is advised. When the terminator is activated, the additional bus (bus out) is disconnected!

Absolute Rotary Encoder with Connector

No internal terminator is present in the absolute rotary encoder. The ICZ-TR-V15B external 220-Ω terminator (see datasheet) can be connected to the "BUS out" connector as needed. See chapter "Electrical Connection."

5.5 LED Indicators

The absolute rotary encoder features 2 LED indicators for displaying the operating status (green) and diagnostic information in case of a fault (red).

Red LED	Green LED	Description
Off	Off	No power supply
On	On	Rotary encoder ready for operation; no configuration data yet received. Possible causes: <ul style="list-style-type: none"> ■ Incorrect address configured ■ Bus line incorrectly connected
On	Flashes	Parameterization or configuration error. The rotary encoder is receiving inconsistent data or data of the wrong length. Possible causes: <ul style="list-style-type: none"> ■ Total resolution set too high
Flashes	On	The rotary encoder is ready for operation but not activated by the master (e.g. incorrect address configured).
On	Off	The rotary encoder has not received any data for a long time (> 40 s) (e.g. data line interrupted).
Off	On	Normal operation, data exchange mode
Off	Flashes	Commissioning mode in data exchange mode

Table 5.2

6 Device Profiles for PROFIBUS

6.1 Device Profile in Accordance with PROFIBUS Encoder Profile

The PROFIBUS profile for encoders (PNO order number 3.062) provides a manufacturer-independent and binding specification of the interface for rotary encoders. This profile specifies the functions used and how they must be used. This enables an open, manufacturer-independent bus system.

The device profile defines the following two device classes.

Device Class 1

"Class 1" describes all the basic functions that must be supported by the PROFIBUS absolute rotary encoder. The following configurable functionality is defined for "Class 1":

Designation	Cyclic Data Exchange	Configurable Parameters	Other
Class 1 Singleturn	Position value – 16-bit input	Counting direction	
Class 1 Multiturn	Position value – 32-bit input	Counting direction	

Table 6.1

According to the Class 1 device profile, the absolute rotary encoder outputs only 16 diagnostic bytes instead of the standard 57 diagnostic bytes.

Device Class 2

"Class 2" specifies extended functions that must be supported by the absolute rotary encoder (mandatory) or that are optional. A "Class 2" absolute rotary encoder therefore supports all "Class 1" and all "Class 2 mandatory" functions. The manufacturer is responsible for implementing the optional functions. The following configurable functionality is defined for "Class 2":

Designation	Cyclic Data Exchange	Configurable Parameters	Other
Class 2 Singleturn	<ul style="list-style-type: none"> ■ Position value – 16-bit input ■ Preset value – 16-bit output 	<ul style="list-style-type: none"> ■ Counting direction ■ Scaling 	Preset function (set rotary encoder zero point to system zero point)
Class 2 Multiturn	<ul style="list-style-type: none"> ■ Position value – 32-bit input ■ Preset value – 32-bit output 	<ul style="list-style-type: none"> ■ Counting direction ■ Scaling 	Preset function (set rotary encoder zero point to system zero point)

Table 6.2

According to the Class 2 device profile, the absolute rotary encoder outputs the standard number of 57 diagnostic bytes.

Data Exchange in Normal Operation

"DDLM_Data_Exchange_Mode" is the normal system state. On request, the absolute rotary encoder sends the current position values to the master. Conversely, the absolute rotary encoder can also receive data transferred cyclically from the master, such as the preset value for Class 2.

The multiturn rotary encoder transfers the current position value as a 32-bit value (word32) to the master. The singleturn rotary encoder transfers only a 16-bit value (word) to the master.

Word	Word 1		Word 2	
Function	Position value			
Bit	31	30	29 ... 16	15 ... 0
	0	0	X ... X	X ... X

Preset value in normal operation

You can also set a preset value as a reference value for the absolute rotary encoder, to adjust the zero point of the rotary encoder to the mechanical zero point of the system, for example. When the preset value is set, the actual value of the rotary encoder is set to the desired preset value. The necessary zero point shift is calculated by the absolute rotary encoder and permanently saved in the EEPROM of the device (< 40 ms). Before setting the preset value, the system must be moved to the desired reference point and must then be at a standstill. The preset value is activated by setting bit 31 in the output word32 (transfer with rising edge).

	Status bits							Data bits
	31	30	29	28	27	26	25	24 ... 0
Master -> rotary encoder	1	0	0	0	0	0	0	Transfer of the desired value for the preset value
Rotary encoder -> master	1	0	0	0	0	0	0	The desired preset value is transferred as the process actual value.
Master -> rotary encoder	0	0	0	0	0	0	0	Reset of bit 31

Table 6.3

A variable table VAT_1 was created by way of illustration. Setting the preset value is described in detail by means of an example using this variable table. The "preset" control bit was defined for this example. The input word32 with example input address ED 100 and output word32 with example output address AD 100 are shown in hexadecimal and binary form.



Setting the Preset Value



Note!

The system must be at a standstill in order to set the preset value, as the current actual value of the rotary encoder is offset.

1. Move the system to the desired reference point, such as the zero point of the system.

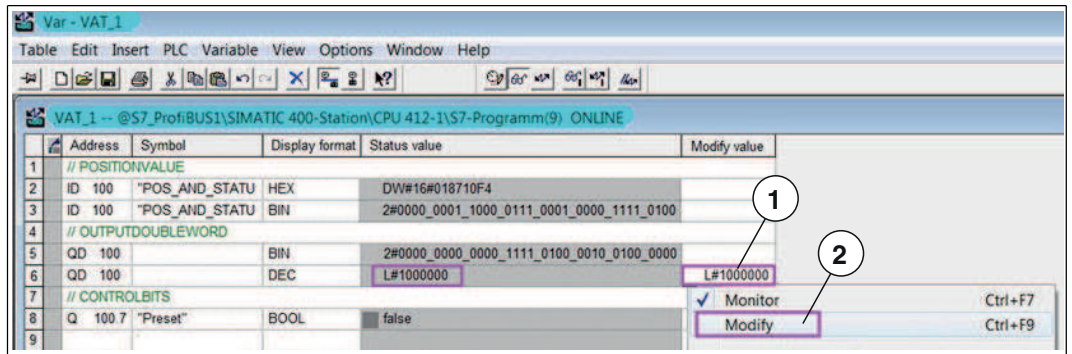

Figure 6.1

2. Enter the desired preset value as a decimal number in the AD100 control word (1), here 1000000
3. Use "Modify" (2) to transfer the preset value entered in the control word to AD100.

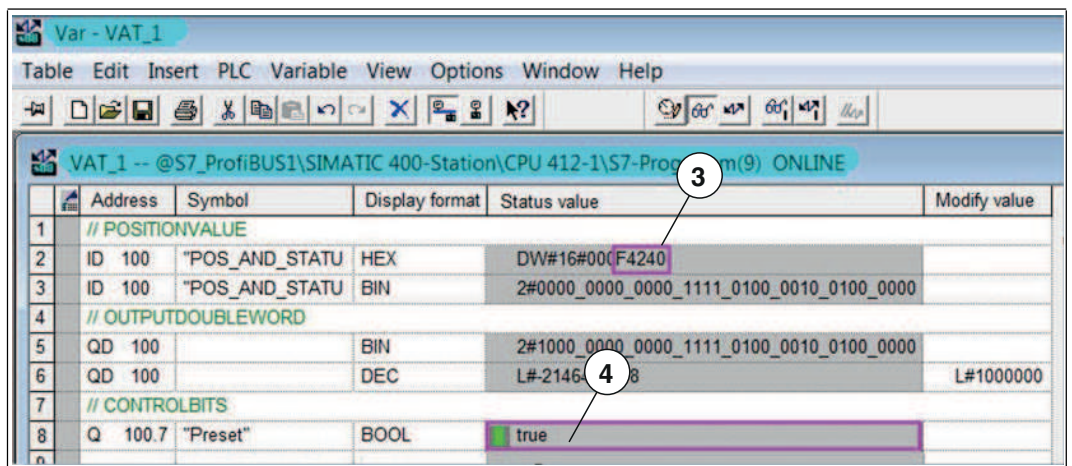

Figure 6.2

4. Change the "Preset" control bit (4) from "false" to "true."
 ↳ When the control bit is set, the value entered is applied as the current output value of the absolute rotary encoder (3). The absolute rotary encoder now outputs the position value, here 0x000F4240h (decimal value 1000000). The absolute rotary encoder calculates the necessary zero point shift or the offset value, and saves this value permanently in the EEPROM of the device.

- Once the absolute rotary encoder has applied the preset value as the new position value, change the "Preset" control bit (5) back from "true" to "false."

The screenshot shows the SIMATIC Manager Variable View for a device named 'VAT_1'. The table below represents the data shown in the screenshot:

Address	Symbol	Display format	Status value	Modify value
// POSITIONVALUE				
ID 100	"POS_AND_STATU	HEX	DW#16#000F4240	
ID 100	"POS_AND_STATU	BIN	2#0000_0000_0000_1111_0100_0010_0100_0000	
// OUTPUTDOUBLEWORD				
QD 100		BIN	2#0000_0000_0000_1111_0100_0010_0100_0000	
QD 100		DEC	L#1000000	L#1000000
// CONTROLBITS				
Q 100.7	"Preset"	BOOL	false	

Figure 6.3



Note!

The procedure described also applies to the singleturn version. In this case, bit 15 is used to activate the preset value. However, a preset value cannot be set for a "Class 2" 16-bit singleturn rotary encoder because bit 15 is used to activate the preset value. If preset functionality is required, one of the P+F manufacturer-specific versions must be used. The preset value is transferred in 32-bit format in these versions, even for singleturn encoders.

6.2 Manufacturer-Specific Device Profile

With the manufacturer-specific **P+F Version 2.1** and **P+F Version 2.2 device classes**, the rotary encoder offers functions such as commissioning mode (teach-in), velocity output and software limit switches in addition to the functions according to the encoder profile of the PROFIBUS user organization.

P+F Version 2.1

The manufacturer-specific parameters in accordance with P+F Version 2.1 determine the following functionality:

Designation	Cyclic Data Exchange	Configurable Parameters	Other
P+F 2.1 Singleturn	<ul style="list-style-type: none"> ■ Position value – 32-bit input ■ Preset value/teach-in – 32-bit output 	<ul style="list-style-type: none"> ■ Counting direction ■ Scaling ■ Gear factor via "Measuring units per revolution" and "Total measuring range" parameters ■ Shorter/longer diagnostics (16/57-byte) ■ Software limit switches 	<ul style="list-style-type: none"> ■ Preset function (set rotary encoder zero point to system zero point) ■ Commissioning mode
P+F 2.1 Multiturn	<ul style="list-style-type: none"> ■ Position value – 32-bit input ■ Preset value/teach-in – 32-bit output 	<ul style="list-style-type: none"> ■ Counting direction ■ Scaling ■ Gear factor via "Measuring units per revolution" and "Total measuring range" parameters ■ Shorter/longer diagnostics (16/57-byte) ■ Software limit switches 	<ul style="list-style-type: none"> ■ Preset function (set rotary encoder zero point to system zero point) ■ Commissioning mode

Table 6.4

P+F Version 2.2

In addition to the parameters described in the "P+F Version 2.1" section, P+F Version 2.2 makes it possible to generate a velocity value for the absolute rotary encoder.

The manufacturer-specific parameters in accordance with P+F Version 2.2 determine the following functionality:

Designation	Cyclic Data Exchange	Configurable Parameters	Other
P+F 2.2 Singleturn	<ul style="list-style-type: none"> ■ Position value – 32-bit input ■ Preset value/teach-in – 32-bit output ■ Velocity 16-bit input 	<ul style="list-style-type: none"> ■ Counting direction ■ Scaling ■ Gear factor via "Measuring units per revolution" and "Total measuring range" parameters ■ Shorter/longer diagnostics (16/57-byte) ■ Software limit switches ■ Unit of the velocity output 	<ul style="list-style-type: none"> ■ Preset function (set rotary encoder zero point to system zero point) ■ Commissioning mode ■ Velocity output
P+F 2.2 Multiturn	<ul style="list-style-type: none"> ■ Position value – 32-bit input ■ Preset value/teach-in – 32-bit output ■ Velocity 16-bit input 	<ul style="list-style-type: none"> ■ Counting direction ■ Scaling ■ Gear factor via "Measuring units per revolution" and "Total measuring range" parameters ■ Shorter/longer diagnostics (16/57-byte) ■ Software limit switches ■ Unit of the velocity output 	<ul style="list-style-type: none"> ■ Preset function (set rotary encoder zero point to system zero point) ■ Commissioning mode ■ Velocity output

Table 6.5

Data Exchange in Normal Operation

The transfer of actual process values as a message is listed in the following table.

In the case of the P+F Version 2.1 and P+F Version 2.2 manufacturer-specific device classes, the position value for the multiturn rotary encoder is generally transferred as 32-bit values (word32). In addition to the 25 bits intended for the position value, 7 further bits are used as status bits. In the (peripheral) output word32, the master sends the preset value and also control bits to the absolute rotary encoder. Depending on the total resolution, more than 25-bit absolute position data may be available for PROFIBUS absolute rotary encoders. In manufacturer-specific device classes P+F Version 2.1 and P+F Version 2.2, position values >

25 bit are not supported. The higher-value bits are overwritten by the status bits. If manufacturer-specific device classes are used with absolute rotary encoders with a physical resolution exceeding 25 bit, the user must assign parameters such that the physical position value is scaled to a maximum output value < 33554432. If absolute values > 25 bit are necessary, device Class 2 must be chosen.

The transfer of actual process values as a message is listed in the following table.

In the case of device class **P+F 2.2**, the current velocity value is transferred in an additional (peripheral) input word:

Identifier	F1 hex				D0 hex	
Rotary encoder >> master	Status + position value				Velocity	
	Status + 2 ²⁴	2 ²³ ... 2 ¹⁶	2 ¹⁵ ... 2 ⁸	2 ⁷ ... 2 ⁰	2 ¹⁵ ... 2 ⁸	2 ⁷ ... 2 ⁰

Table 6.6

For both singleturn and multiturn absolute rotary encoders, the velocity is a 16-bit value (word).

Identifier				
Master >> rotary encoder	Control bits + preset value			
	Control + 2 ²⁴	2 ²³ ... 2 ¹⁶	2 ¹⁵ ... 2 ⁸	2 ⁷ ... 2 ⁰

Table 6.7

The status bits in the input word³² have the following meaning:

Bit	Meaning
25	Readiness for operation <ul style="list-style-type: none"> ■ 0 = rotary encoder not ready for operation ■ 1 = rotary encoder ready for operation
26	Operating mode <ul style="list-style-type: none"> ■ 0 = commissioning mode ■ 1 = normal mode
27	Software limit switches <ul style="list-style-type: none"> ■ 0 = lower limit switch ≤ actual value ≤ upper limit switch ■ 1 = actual value > upper limit switch, or actual value < lower limit switch
28	Counting direction <ul style="list-style-type: none"> ■ 0 = increasing clockwise (when looking at the shaft) ■ 1 = increasing counterclockwise (when looking at the shaft)

Table 6.8

7 Configuring the Rotary Encoder Using Step7

7.1 Introduction

The following pages provide an example of how to configure a Pepperl+Fuchs absolute rotary encoder using the SIMATIC Manager Step7 (Version 5.5 SP4) project planning tool from SIEMENS.

The following hardware components are used:

- PVM58 absolute rotary encoder (PROFIBUS)
- SIMATIC S7-400 CPU 412-1 (with integrated PROFIBUS interface)



Note!

Before starting configuration with the project planning tool, the relevant GSD file must be downloaded from Pepperl+Fuchs and imported into the project planning tool.

Steps for Integrating the Rotary Encoder

To ensure correct installation, configuration, and parameterization of the rotary encoder, you must carry out the steps described on the following pages in the specified order:

- Install the GSD file
- Select the rotary encoder and assign the DP address
- Select the device class.
- Set the parameters for the rotary encoder in accordance with the device class (Class 1, Class 2, P+F 2.1, P+F 2.2)
- Download to PLC module



Note!

If you want to use more than one rotary encoder in this PROFINET network, you must assign each rotary encoder with its own name and carry out the steps listed for each rotary encoder individually.

7.2 Installing the GSD file

Downloading the GSD file



Note!

How to find GSD file?

You can find the appropriate GSD file in the **Software** section of the product detail page for the device.

To access the product detail page, go to <http://www.pepperl-fuchs.com> and type information about the device (e. g. product description or the item number) into the search function.

1. Download the appropriate GSD file for your absolute rotary encoder and store this in any directory.
2. Start the SIMATIC Manager.

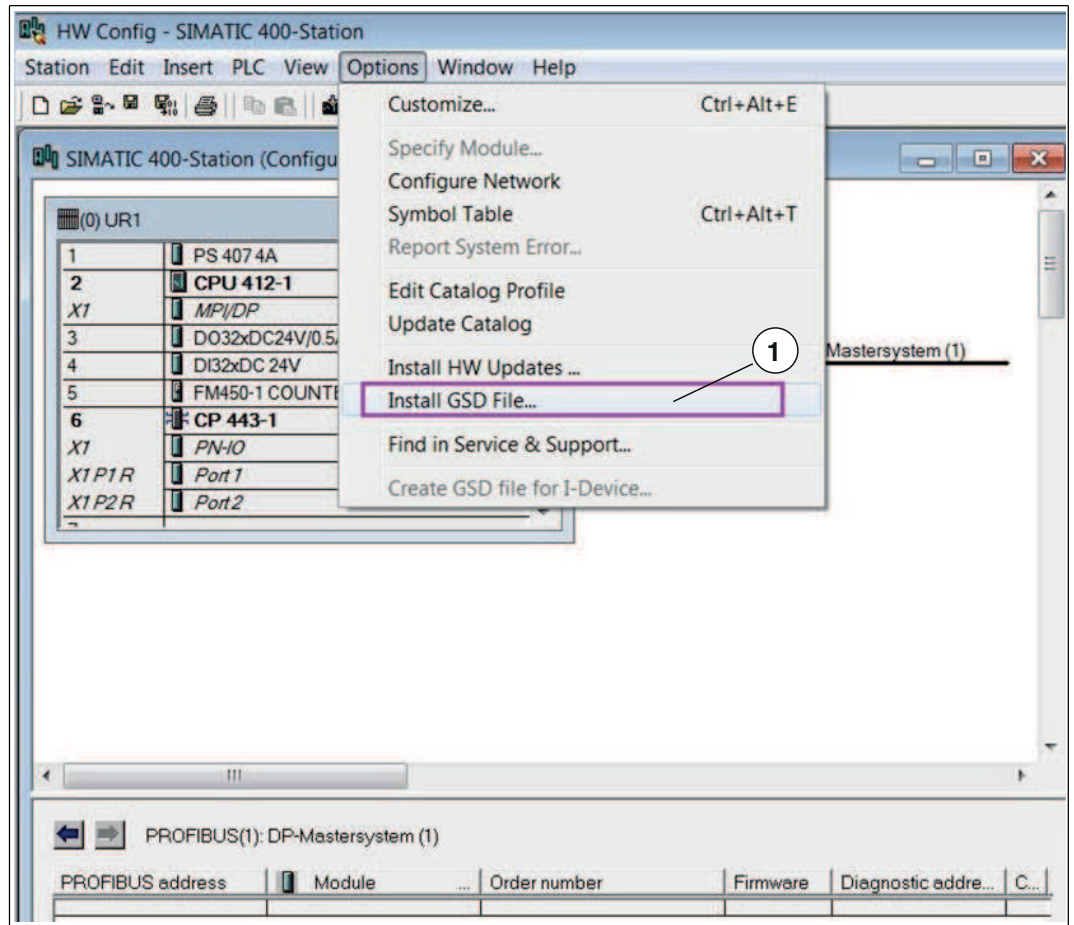

Figure 7.1

3. Select "Options >> Install GSD file ..." (1). Proceed through the following relevant menus and install the required GSD file.

7.3 Select the Rotary Encoder and Assign the DP Address

Prerequisite: A PROFIBUS DP master system has already been created for the project.

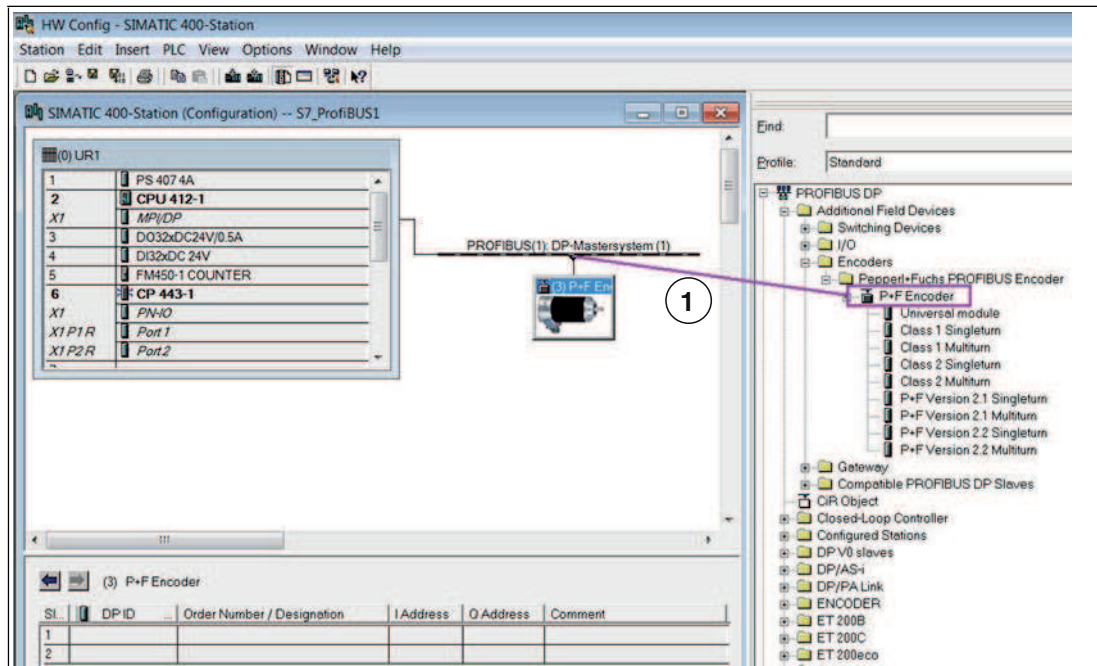

Figure 7.2



Selecting a Rotary Encoder

1. In the area on the right (catalog), select the desired rotary encoder type (1).
2. Click and hold on this rotary encoder type, and drag it to the left into the existing PROFIBUS DP master system.

↳ When the mouse button is released, the following menu opens automatically so that the DP address (subscriber address) of the absolute rotary encoder can be entered.



Note!

The "P+F Encoder" symbol on the PROFIBUS segment is displayed only once you have entered the DP address (subscriber address) in the project planning tool.



Assigning a DP Address

1. In the menu (1), set the DP address (subscriber address) that is configured on the connection cover of the absolute rotary encoder.

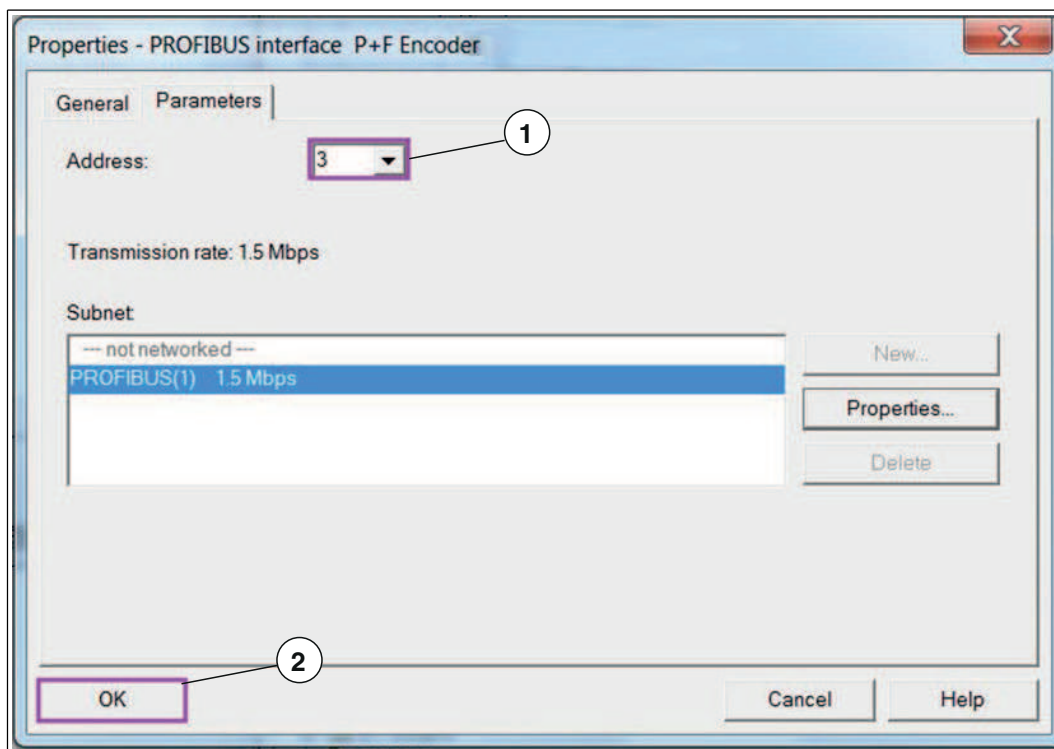

Figure 7.3

2. Click the OK button (2) to confirm the entry.

7.4

Select the Device Class.

Overview

As described in "Device Profiles for PROFIBUS" chapter, the functionality of the device depends on the device class selected. Once you have integrated the device in the PROFIBUS network as described, you can assign the desired device class in the next step.

The following device classes can be selected as versions for singleturn or multiturn absolute rotary encoders:

- Class 1
- Class 2
- P+F Version 2.1
- P+F Version 2.2



Assigning the Device Class

As an example for all instances, a description for assigning the device class "Class 1 Multiturn" follows.

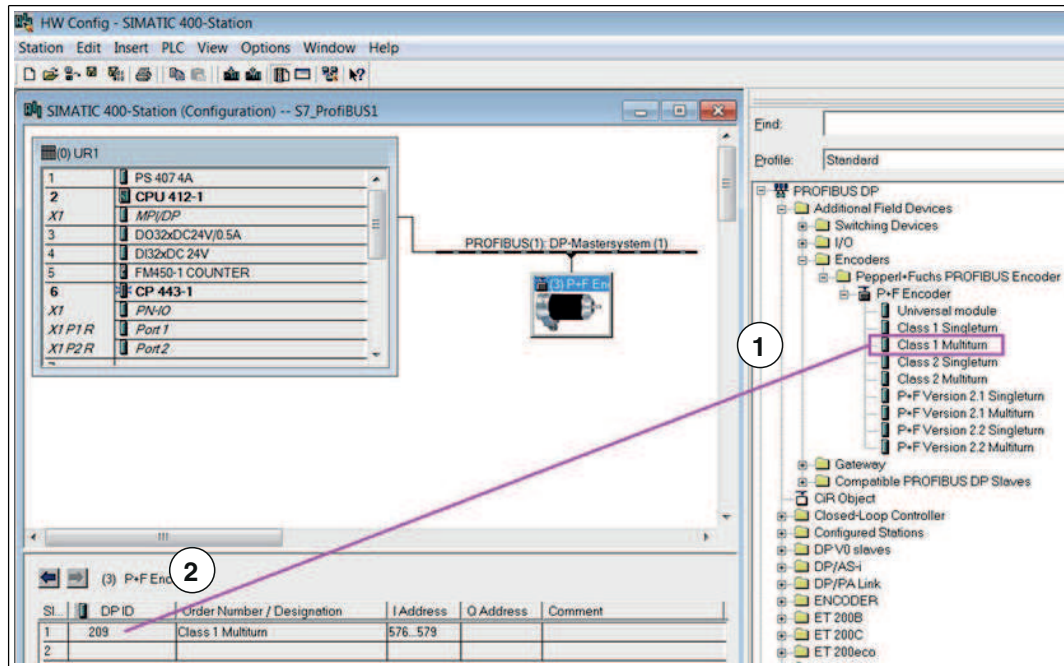

Figure 7.4

3. Click and hold the mouse button on the desired device class (1), and drag it to slot 1 (2) at the bottom left.

7.5 Adjusting the Rotary Encoder Parameters in Accordance with Device Class 1



Checking the Prerequisite



Note!

If device Class 1 is selected, only the counting direction can be parameterized. A preset is not possible. The absolute output position value corresponds to the basic resolution of the absolute rotary encoder according to the information on the nameplate.

Prerequisite: Device Class 1 is selected (1).

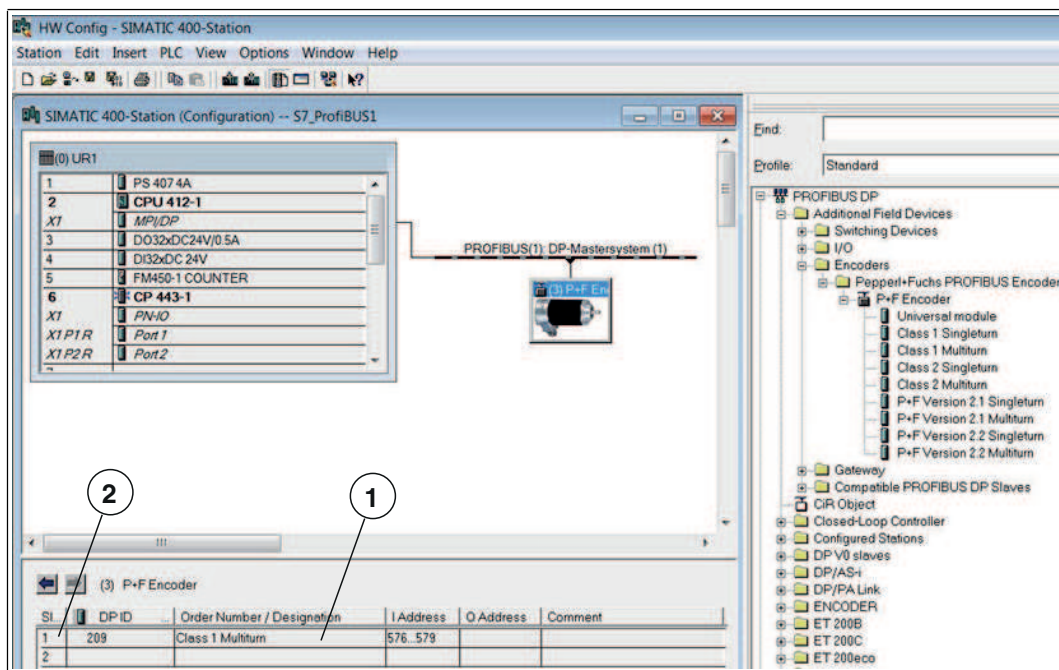

Figure 7.5

4. Double-click on **Slot 1** in the table (2).

↳ The **Properties - DP ID** menu is displayed.



Entering Addresses for Inputs

1. Enter the desired addresses of the inputs (1) in the **Address/ID** tab. "100" is selected here as an example.

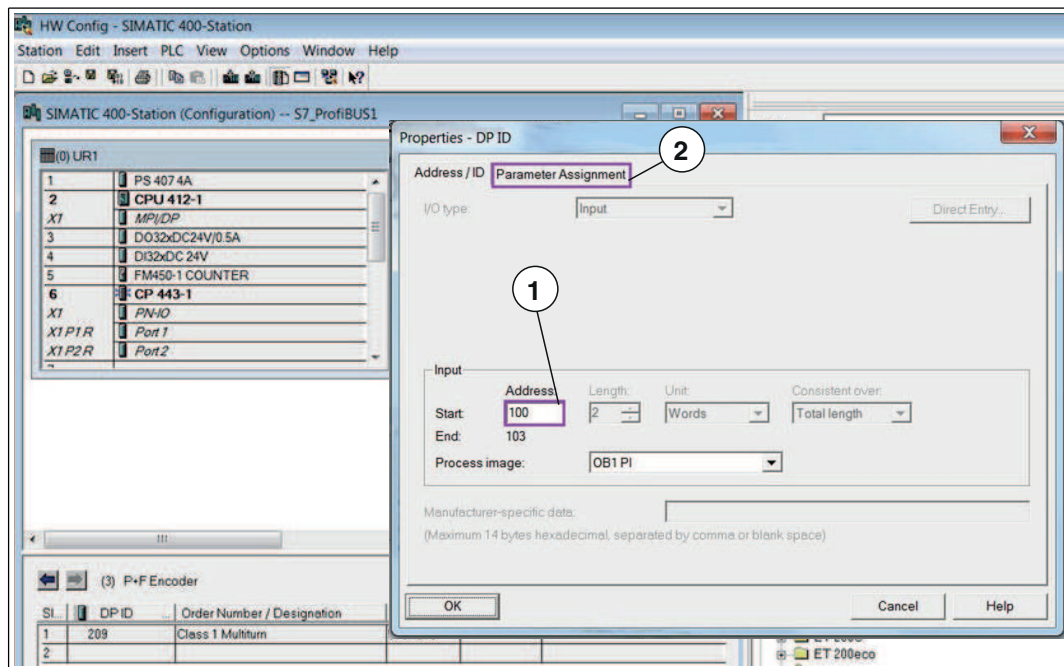

Figure 7.6

2. Click the **Parameter Assignment** tab (2) to call up the basic functions to be adjusted.

Setting the Counting Direction

You can select the counting direction of the absolute rotary encoder as follows. The counting direction is set in the direction of view of the shaft.

- Increasing clockwise (0): absolute output position value "increasing" when the direction of rotation of the shaft is "clockwise"
- Decreasing clockwise (1): absolute output position value "decreasing" when the direction of rotation of the shaft is "clockwise"



Setting the Parameters

1. Click on the **Code sequence** function (1) in the **Device-specific parameters** section.

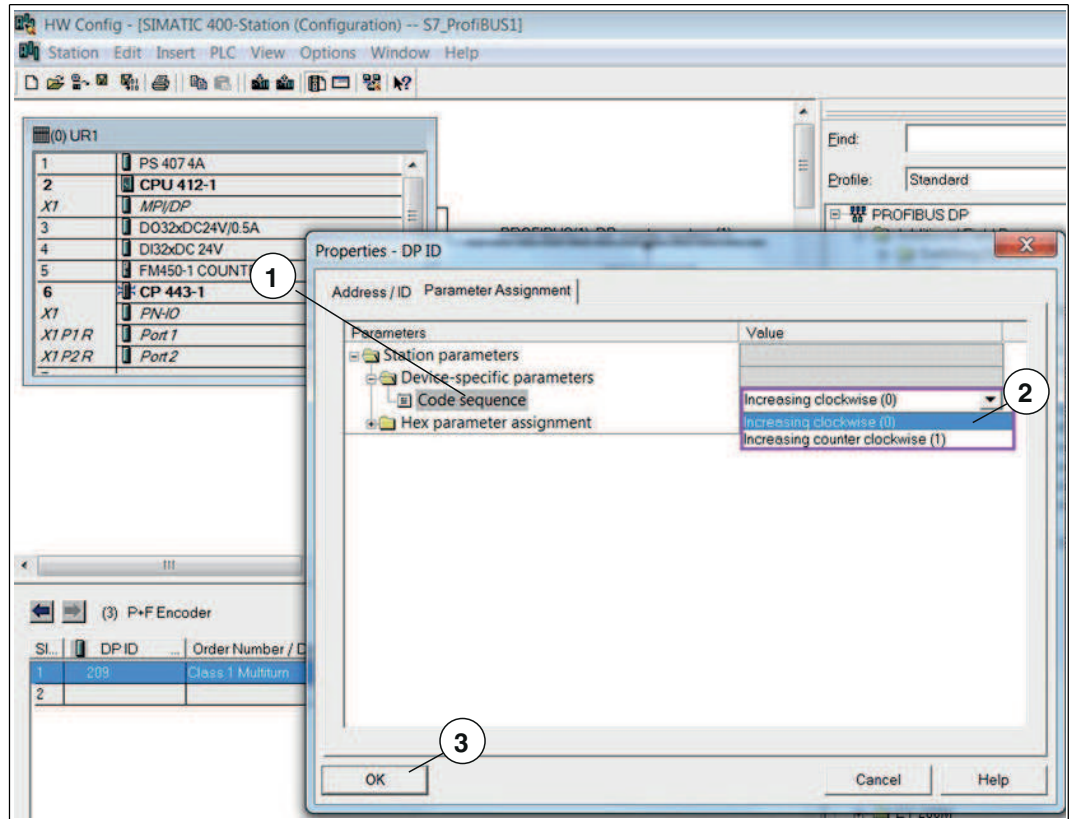

Figure 7.7

2. Set the desired counting direction (2).
3. Click the OK button (3) to confirm the entry.

▶ Saving and Compiling the Station

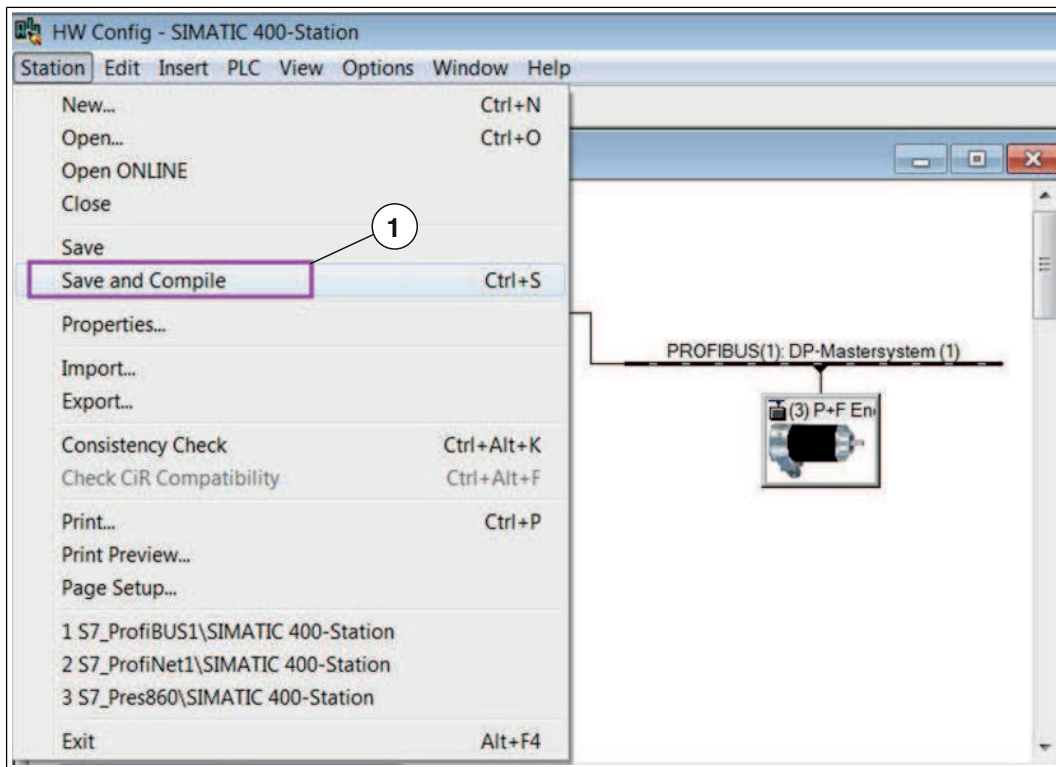

Figure 7.8

- 4. Once all parameters have been set, select "Station >> Save and Compile" (1).
↳ Once parameterization is complete, you must load the configuration in the controller. Continue with the **"Download to PLC Module"** chapter.

7.6 Adjusting the Rotary Encoder Parameters in Accordance with Device Class 2



Checking the Prerequisite

Prerequisite: Device Class 2 is selected (1).

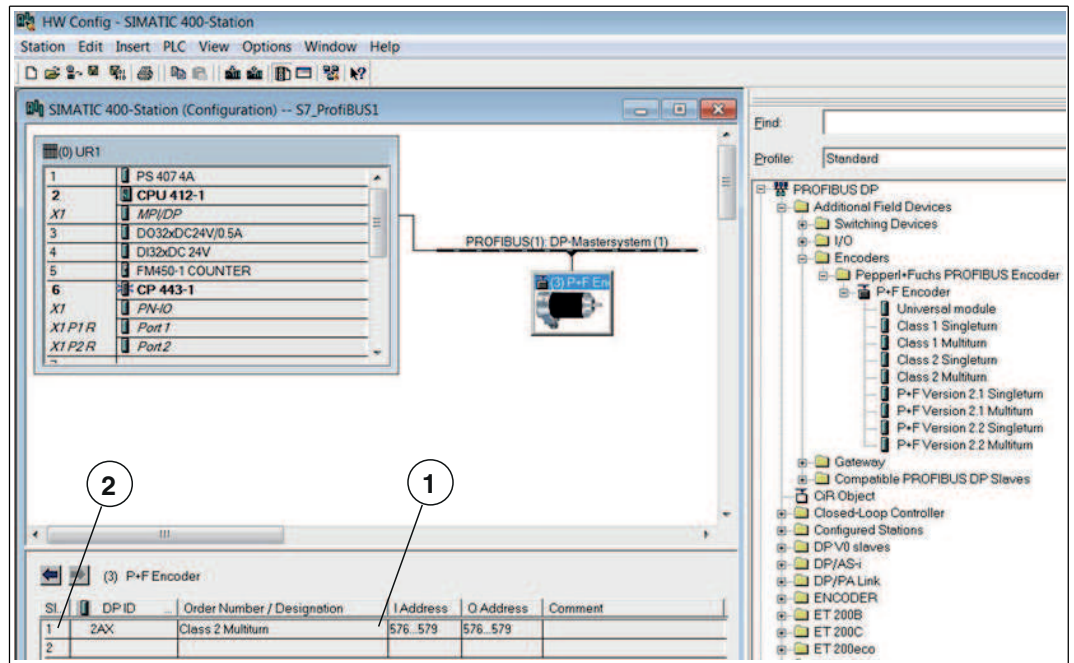

Figure 7.9

5. Double-click on **Slot 1** in the table (2).

↳ The **Properties - DP ID** menu is displayed.



Inputting Addresses for Inputs/Outputs

1. Enter the desired input and output addresses (1) in the **Address/ID** tab. "100" is selected here as an example.

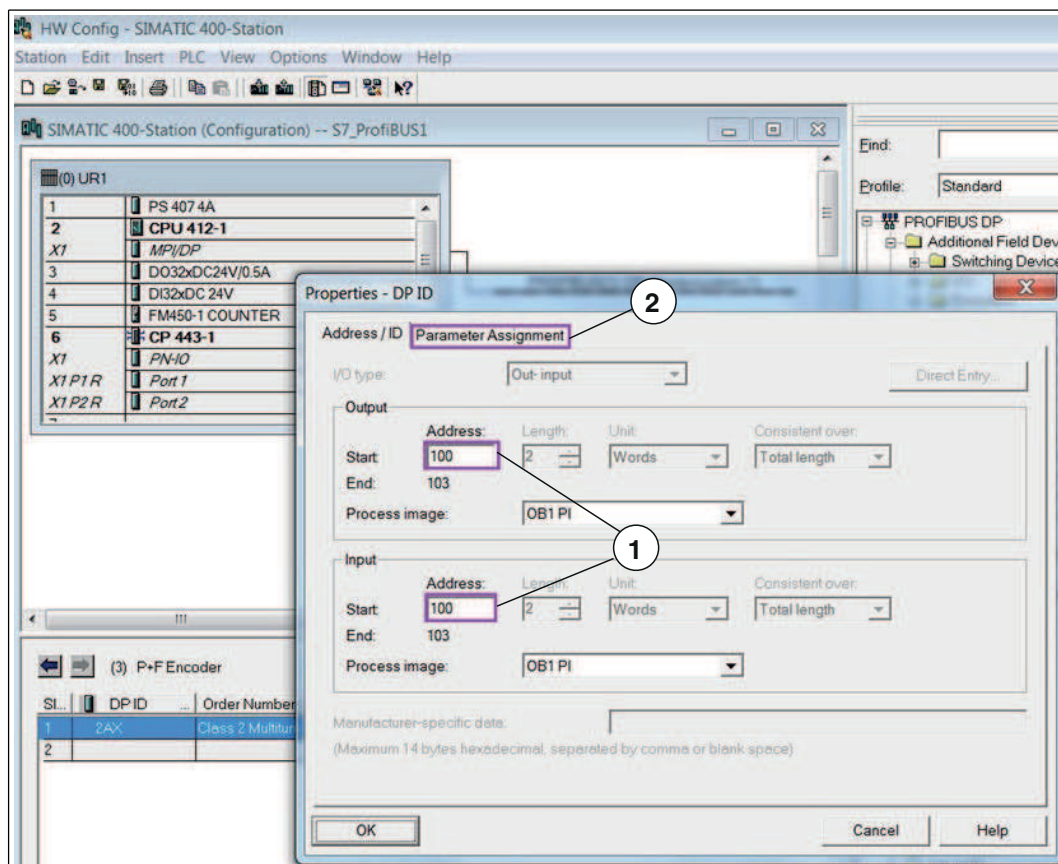

Figure 7.10

2. Click the **Parameter Assignment** tab (2) to call up the adjustable device-specific parameters.

Parameters in Accordance with Device Class 2

The following parameters of the absolute rotary encoder can be adjusted in accordance with device Class 2:

Counting direction: The counting direction is set in relation to the direction of view of the shaft.

- Increasing clockwise (0): absolute output position value "increasing" when the direction of rotation of the shaft is "clockwise"
- Decreasing clockwise (1): absolute output position value "decreasing" when the direction of rotation of the shaft is "clockwise"

Class 2 functionality: Activate or deactivate Class 2 functionality.

- Deactivated: Class 2 functions are deactivated, Class 1 functions are available
- Activated: Class 2 functions are activated, parameterization is enabled

Scaling function: Activate or deactivate scaling function.

- Deactivated: scaling function is deactivated
- Activated: scaling function is activated, parameterization of "steps per revolution" and "total resolution" is enabled

Steps per revolution: A desired number of steps per revolution can be assigned to the absolute rotary encoder.

Total resolution: The entire measuring range of the absolute rotary encoder can be adjusted here (steps per revolution x number of revolutions). The absolute rotary encoder counts up to the parameterized total resolution-1 and then starts again at 0.



Note!

If the value entered for the "total resolution" parameter exceeds the actual (physical) basic resolution of the absolute rotary encoder, then the output value is no longer in single steps. In this case, a parameter error is displayed. The absolute rotary encoder does not go into cyclic data exchange.

The period is defined as "total resolution/measuring step per revolution" and must always be an integer. If n measuring steps per revolution are selected, the selected total resolution must not lead to a period that is longer than the maximum available (physical) revolutions of the device according to the nameplate. For a multiturn device with 16,384 revolutions, the total resolution must be less than 16,384 times the parameterized measuring steps per revolution (in SIMATIC 400 station: steps per revolution).

The following rule applies:

Total resolution < (measuring steps per revolution x number of revolutions [physical])

Normally, dividing the "Total measuring range" (as a decimal number) by "Measuring steps per revolution" must result in an integer. The total measuring range must also fit into an integer multiple of 4096 for an absolute rotary encoder with 12 bits per revolution. This means that 100 or 325 revolutions, for example, could result in faults. PROFIBUS absolute rotary encoders from Pepperl+Fuchs use an internal software routine to automatically correct any deviation from these rules, to prevent faults.



Caution!

Functionality of the Internal Software Routine

The internal software routine is active only when the absolute rotary encoder from Pepperl+Fuchs is connected to the power supply. If it is necessary to turn the shaft of the absolute rotary encoder by more than 1024 revolutions without a power supply, this can result in faults. If this is necessary, the following rule should be observed:

$(4096 \times \text{measuring steps per revolution}) / \text{total resolution} = \text{integer}$

For absolute rotary encoders with 16,384 (14-bit) revolutions: If the possibility of the shaft of the absolute rotary encoder being turned by more than 4096 revolutions without a power supply cannot be excluded, then the following rule applies:

$(16384 \times \text{measuring steps per revolution}) / \text{total resolution} = \text{integer}$



Note!

The STEP 7 project planning software previously required 32-bit parameter values for total resolution, limit switch, and so on to be entered as separate high and low word values. With the current version and the current GSD file, the total value can now be entered as a decimal up to a size of 32 bit.

Setting the Parameters

1. Click on the desired advanced functions (1) in the **Device-specific parameters** section.

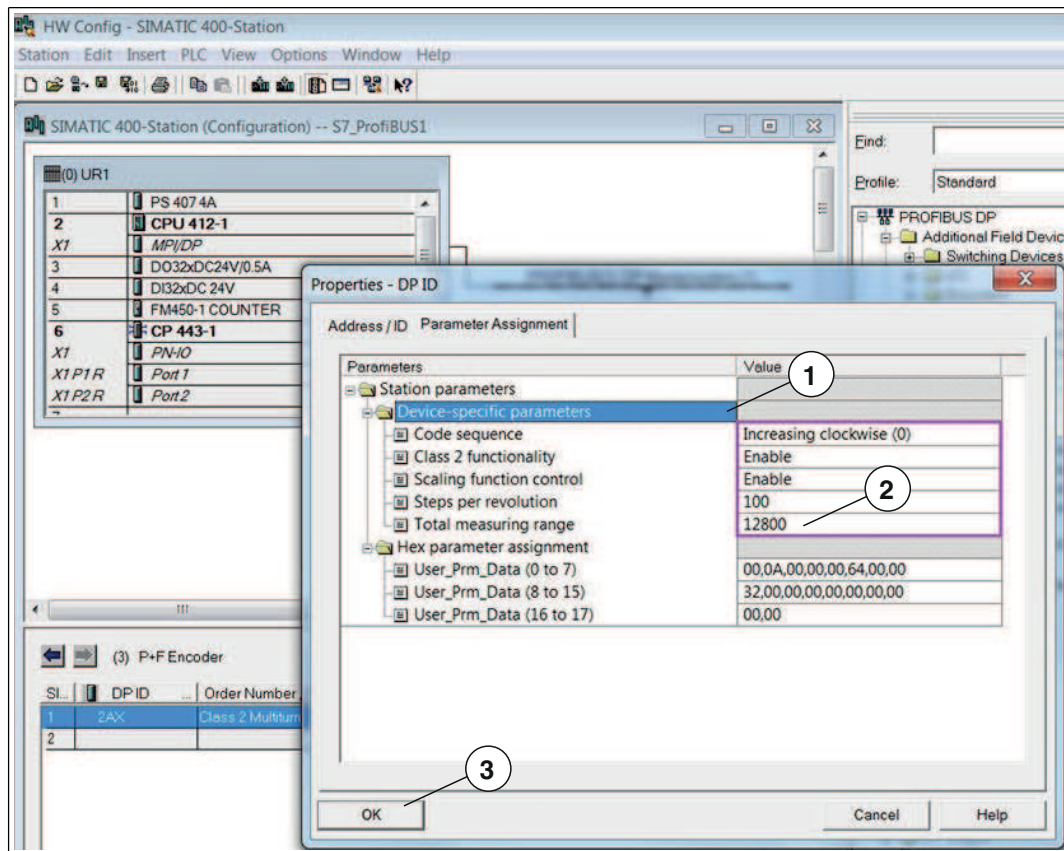

Figure 7.11

2. Adjust the relevant functions.

↳ In (2), a resolution of 100 steps and a total resolution of 12,800 are selected. After 128 revolutions, the absolute rotary encoder starts again at 0 and then counts up to 11,799 again.

3. Click the OK button (3) to confirm the entry.

▶ Saving and Compiling the Station

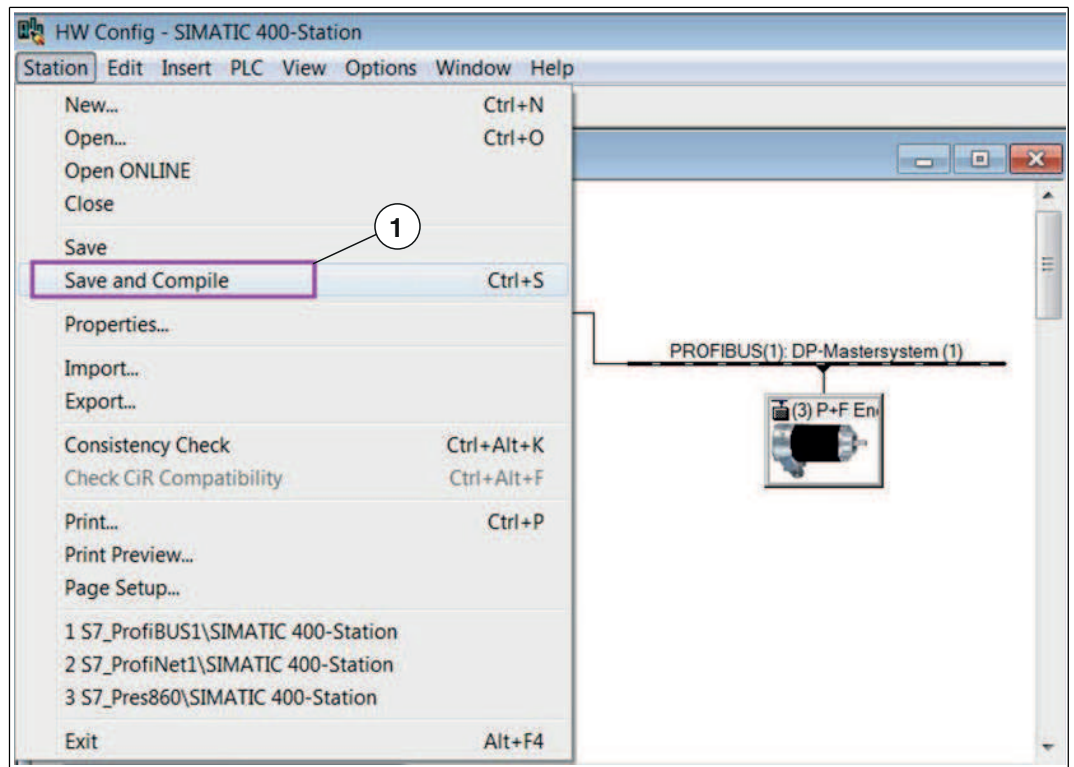

Figure 7.12

4. Once all parameters have been set, select "Station >> Save and Compile" (1).
↳ Once parameterization is complete, you must load the configuration in the controller. Continue with the "**Download to PLC Module**" chapter.

7.7 Adjusting the Rotary Encoder Parameters in Accordance with Device Class P+F V2.1

▶ Checking the Prerequisite

Prerequisite: Manufacturer-specific device class P+F Version 2.1 is selected (1).

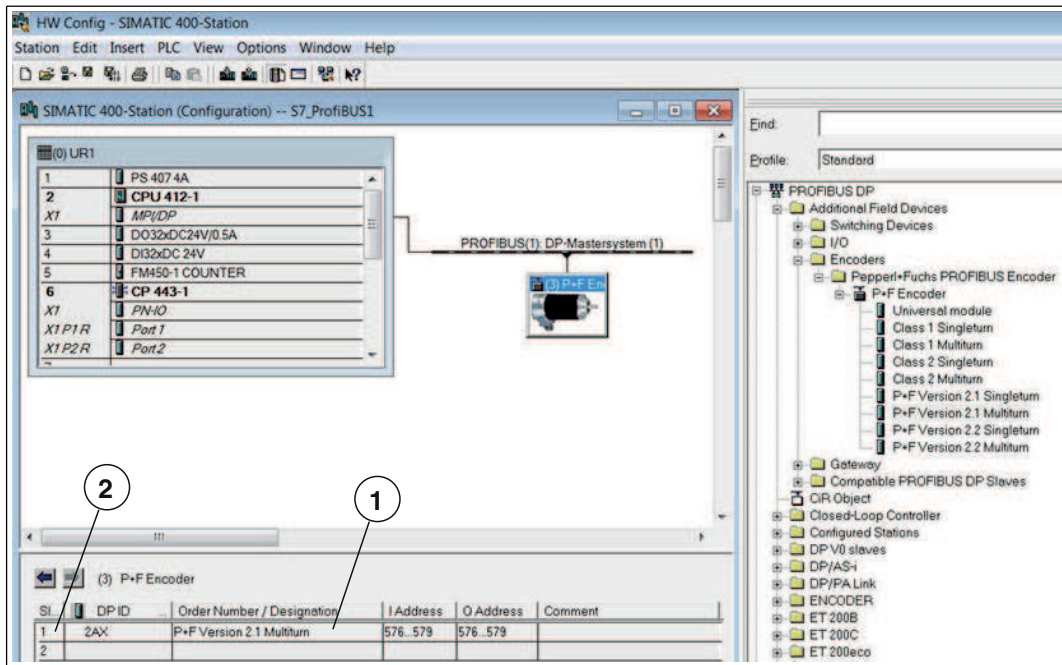

Figure 7.13

5. Double-click on **Slot 1** in the table (2).

↳ The **Properties - DP ID** menu is displayed.



Inputting Addresses for Inputs/Outputs

1. Enter the desired input and output addresses (1) in the **Address/ID** tab. "100" is selected here as an example.

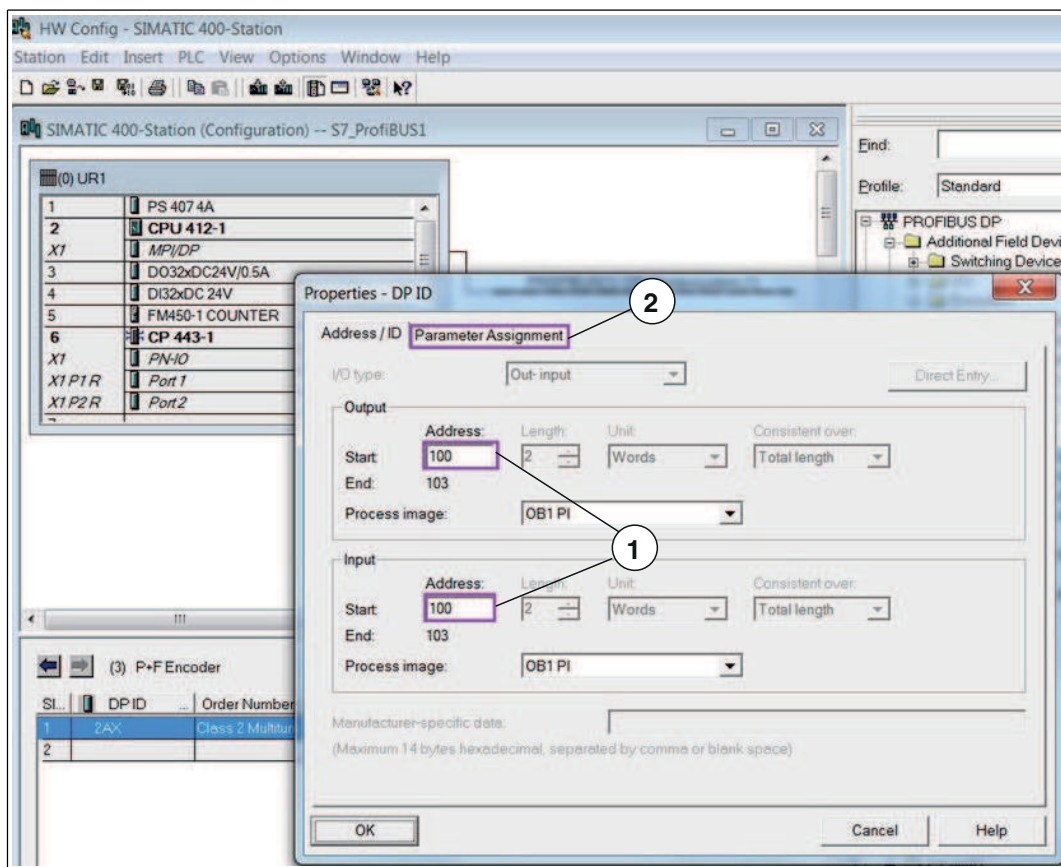

Figure 7.14

2. Click the **Parameter Assignment** tab (2) to call up the device-specific parameters to be adjusted.

Parameters in Accordance with Manufacturer-Specific Device Class P+F Version 2.1

The following sections describe the parameters that you can adjust for manufacturer-specific device class P+F Version 2.1 for the absolute rotary encoder:

Counting direction: The counting direction is set in relation to the direction of view of the shaft.

- Increasing clockwise (0): absolute output position value "increasing" when the direction of rotation of the shaft is "clockwise"
- Decreasing clockwise (1): absolute output position value "decreasing" when the direction of rotation of the shaft is "clockwise"

Scaling function: Activate or deactivate scaling function.

- Deactivated: scaling function is deactivated
- Activated: scaling function is activated, parameterization of "steps per revolution" and "total resolution" is enabled

Resolution/Measuring Step Parameters (Gear Factor)

The following parameters enable you to adjust the output scaling and gear factor for the absolute rotary encoder in accordance with your application. The parameters are related to one another. This results in logical relationships, which must be taken into account when setting parameters. An example is provided below to clarify the connections.

Total resolution: The entire measuring range of the absolute rotary encoder can be adjusted here (steps per revolution x number of revolutions). The absolute rotary encoder counts up to the parameterized total resolution-1 and then starts again at 0.

Desired measuring units: You must input an integer for this parameter. What the inputted measuring steps relate to is determined by setting the next parameter, "Desired measuring units per."

Physical impulses: This parameter is evaluated by the device if the "Physical impulses" option was defined as the reference for the "Desired measuring units" (see below). A gear factor can be freely adjusted using the "Physical impulses" parameter. This specifies how many measuring steps ("Desired measuring units") should be output for a specified partial measuring range. This option is helpful if "uneven" scaling factors are to be entered.

Desired measuring units per: This parameter is used to program the device so that a desired number of measuring steps can be performed, based on one of the following aspects:

- **Revolution:** The position value is scaled such that the position value increases for each revolution by the number of steps input as the "Desired measuring units" parameter. The "Total measuring range" parameter, used to adjust the measuring range, is also evaluated.
- **Maximal total measuring range:** The value entered as the "Desired measuring units" parameter relates to the entire measuring range of the device. This means that the device outputs the specified number of measuring steps via the number of complete (physical) revolutions.
- **Physical measuring steps:** In this case, the "Desired measuring units" parameter relates to the steps that are entered as the "Physical impulses" parameter. In this case, physical measuring steps means the numerical value that is read internally by the rotary encoder from the code disc, e.g. 4096 steps per revolution for the standard 12-bit variant. Gear factors can be freely adjusted with this option.



Example!

Problem: The absolute rotary encoder should output 400 steps over three revolutions. This step number cannot be set with the "Desired measuring units per -> revolutions" reference. The parameter would need to contain the value 133,333. However, the value entered must be an integer.

Solution

The "Physical measuring units" are selected as the reference for the desired measuring steps. Using the actual (physical) resolution of the device according to the nameplate, the number for the "physical impulses" is determined via the desired measuring range. In the case of an absolute rotary encoder with 12-bit standard resolution:

$$4096 \text{ steps/revolution} \times 3 \text{ revolutions} = 12,288 \text{ steps}$$

This value is now entered as the "Physical impulses" parameter. The actual desired step number of 400 is entered under "Desired measuring units." The absolute rotary encoder now outputs 400 steps over a measuring range of 12,288 physical steps, i.e. 3 revolutions.

Software Limit Switch Parameters

You can program two positions such that when these positions are exceeded or not reached, the absolute rotary encoder sets bit 27 in the 32-bit process actual value to "1." The bit is set to "0" between the two positions. You can input any parameter values for the two limit switch values. However, the values must not exceed the value of the "Total measuring range" parameter.

Lower limit switch: Activate or deactivate the limit switch function and entry of the trigger measuring step in relation to the scaled value.

- Deactivated: lower limit switch is deactivated
- Activated: lower limit switch is activated

Upper limit switch: Activate or deactivate the limit switch function and entry of the trigger measuring step in relation to the scaled value.

- Deactivated: upper limit switch is deactivated
- Activated: upper limit switch is activated

Other Parameters

Commissioning mode: Activate or deactivate commissioning mode.

- Deactivated: commissioning mode is deactivated
- Activated: commissioning mode is activated

Commissioning mode is a special mode of the device that enables you to transfer parameters in addition to the preset value.



Note!

A detailed description of how to use commissioning mode can be found in the "Commissioning Mode" chapter.

Shorter diagnostics: Set shorter/longer number of diagnostic bytes.

- Yes: reduced number of 16 diagnostic bytes
- No: standard number of 57 diagnostic bytes

The standard number of 57 diagnostic bytes can lead to problems for some PROFIBUS masters. Older masters in particular are often not able to process the full number. For absolute rotary encoders, it is possible to reduce the output of diagnostic bytes to 16.



Setting the Parameters

1. Click on the desired advanced functions (1) in the **Device-specific parameters** section.

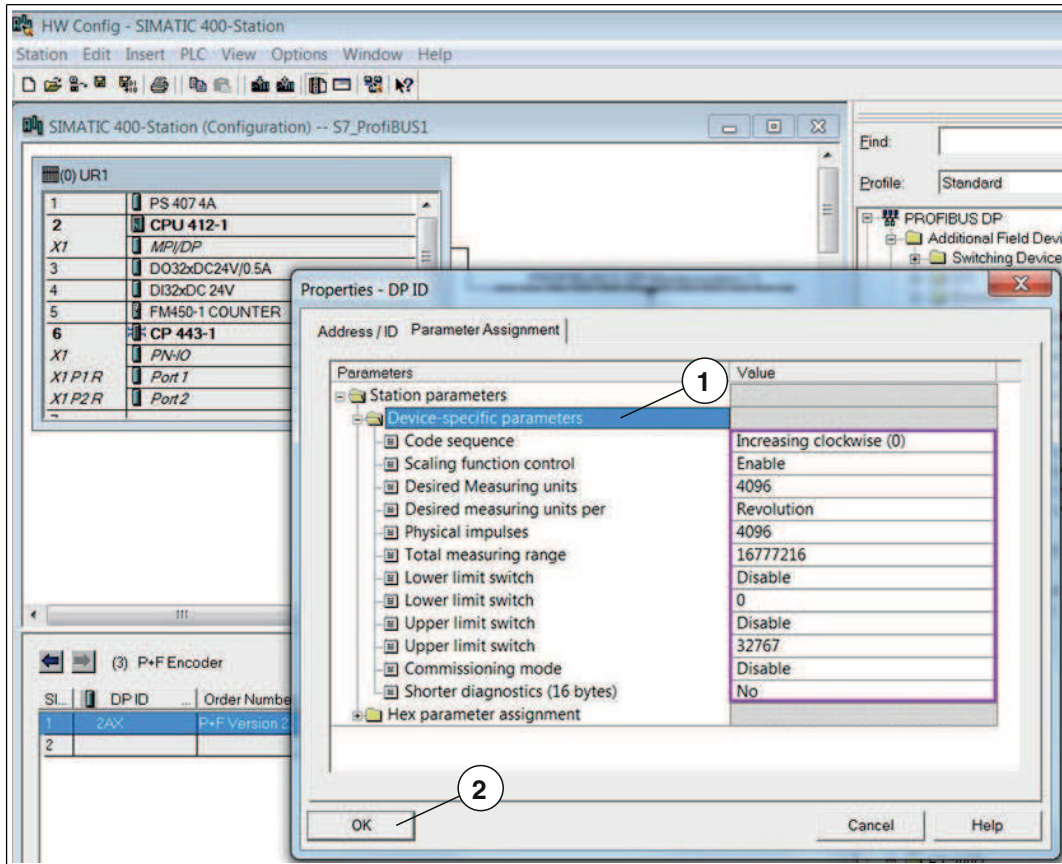

Figure 7.15

2. Adjust the relevant functions.
3. Click the OK button (2) to confirm the entry.



Saving and Compiling the Station

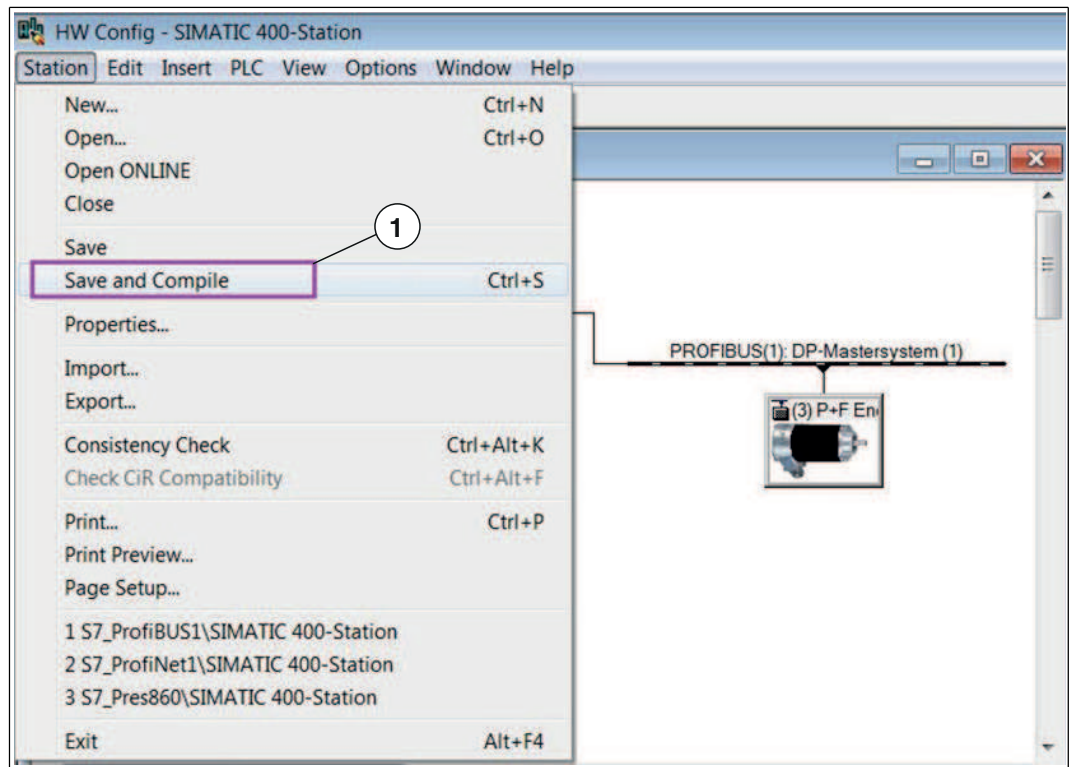

Figure 7.16

4. Once all parameters have been set, select "Station >> Save and Compile" (1).
↳ Once parameterization is complete, you must load the configuration in the controller. Continue with the **"Download to PLC Module"** chapter.

7.8

Adjusting the Rotary Encoder Parameters in Accordance with Device Class P+F V2.2



Note!

In the case of the P+F Version 2.2 device class, the system also provides a second slot. This is because a second section is required for input data for the velocity value parameter. You must therefore define input/output addresses for slot 1, as well as the input addresses for slot 2, if these addresses deviate from the default settings in your application. In terms of sequence, the input address for slot 2 should generally be defined first.



Checking the Prerequisite

Prerequisite: Manufacturer-specific device class P+F Version 2.2 is selected (3).

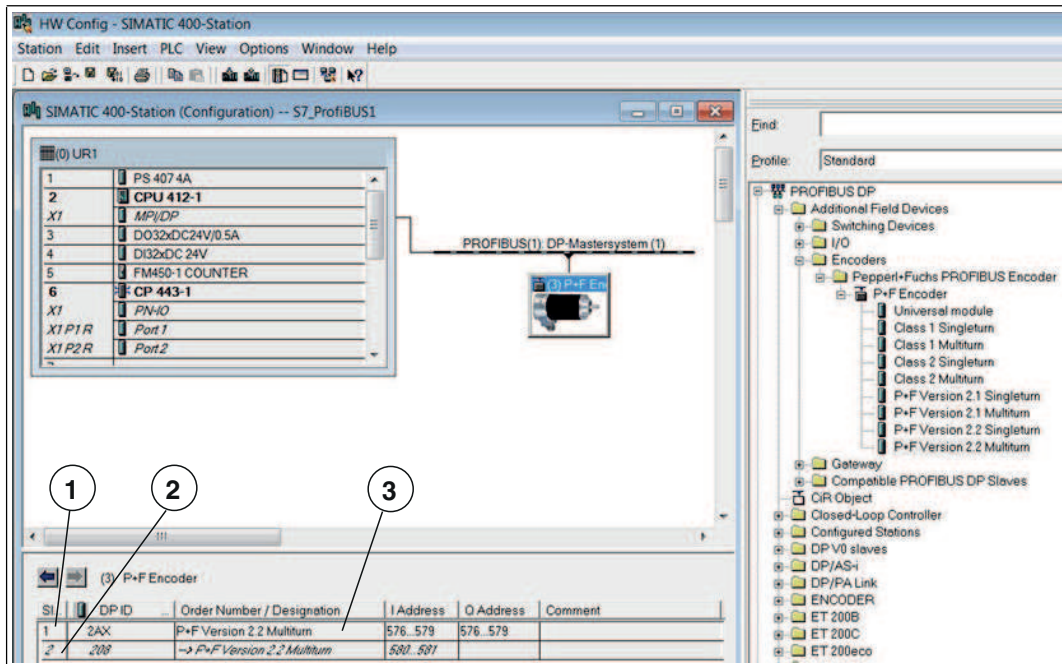

Figure 7.17

5. Double-click on **Slot 2** in the table (2).
↳ The **Properties - DP ID** menu for slot 2 is displayed.
6. Enter the desired start address of the inputs in the **Address/ID** tab. "104," for example.
7. Confirm the entry with OK.
8. Double-click on **Slot 1** in the table (1).
↳ The **Properties - DP ID** menu for slot 1 is displayed.



Entering Addresses for Slot 1

1. Enter the desired input and output addresses (1) in the **Address/ID** tab. "100" is selected here as an example.

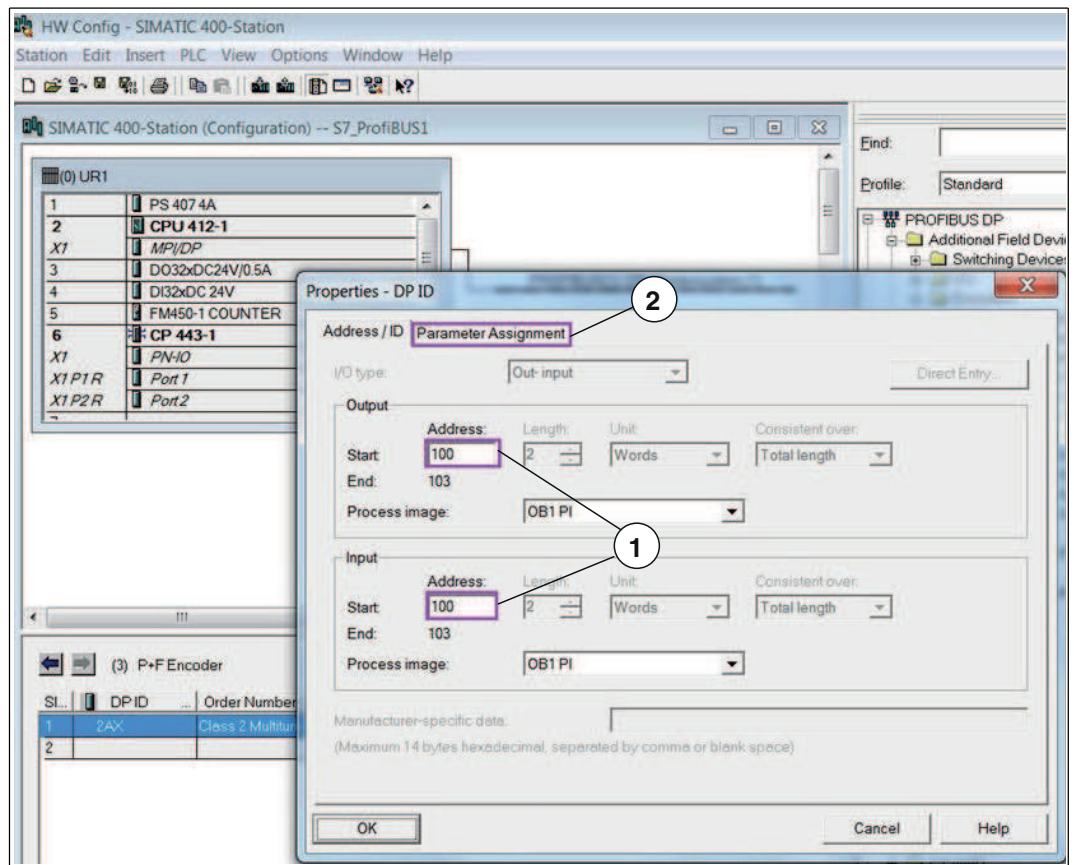

Figure 7.18

2. Click the **Parameter Assignment** tab (2) to call up the device-specific parameters to be adjusted.

Parameters in Accordance with Manufacturer-Specific Device Class P+F Version 2.2

The following sections describe the parameters that you can adjust for manufacturer-specific device class P+F Version 2.2 for the absolute rotary encoder:

Counting direction: The counting direction is set in relation to the direction of view of the shaft.

- Increasing clockwise (0): absolute output position value "increasing" when the direction of rotation of the shaft is "clockwise"
- Decreasing clockwise (1): absolute output position value "decreasing" when the direction of rotation of the shaft is "clockwise"

Scaling function: Activate or deactivate scaling function.

- Deactivated: scaling function is deactivated
- Activated: scaling function is activated, parameterization of "steps per revolution" and "total resolution" is enabled

Resolution/Measuring Step Parameters (Gear Factor)

The following parameters enable you to adjust the output scaling and gear factor for the absolute rotary encoder in accordance with your application. The parameters are related to one another. This results in logical relationships, which must be taken into account when setting parameters. An example is provided below to clarify the connections.

Total resolution: The entire measuring range of the absolute rotary encoder can be adjusted here (steps per revolution x number of revolutions). The absolute rotary encoder counts up to the parameterized total resolution-1 and then starts again at 0.

Desired measuring units: You must input an integer for this parameter. What the inputted measuring steps relate to is determined by setting the next parameter, "Desired measuring units per."

Physical impulses: This parameter is evaluated by the device if the "Physical impulses" option was defined as the reference for the "Desired measuring units" (see below). A gear factor can be freely adjusted using the "Physical impulses" parameter. This specifies how many measuring steps ("Desired measuring units") should be output for a specified partial measuring range. This option is helpful if "uneven" scaling factors are to be entered.

Desired measuring units per: This parameter is used to program the device so that a desired number of measuring steps can be performed, based on one of the following aspects:

- **Revolution:** The position value is scaled such that the position value increases for each revolution by the number of steps input as the "Desired measuring units" parameter. The "Total measuring range" parameter, used to adjust the measuring range, is also evaluated.
- **Maximal total measuring range:** The value entered as the "Desired measuring units" parameter relates to the entire measuring range of the device. This means that the device outputs the specified number of measuring steps via the number of complete (physical) revolutions.
- **Physical measuring steps:** In this case, the "Desired measuring units" parameter relates to the steps that are entered as the "Physical impulses" parameter. In this case, physical measuring steps means the numerical value that is read internally by the rotary encoder from the code disc, e.g. 4096 steps per revolution for the standard 12-bit variant. Gear factors can be freely adjusted with this option.



Example!

Problem: The absolute rotary encoder should output 400 steps over three revolutions. This step number cannot be set with the "Desired measuring units per -> revolutions" reference. The parameter would need to contain the value 133,333. However, the value entered must be an integer.

Solution

The "Physical measuring units" are selected as the reference for the desired measuring steps. Using the actual (physical) resolution of the device according to the nameplate, the number for the "physical impulses" is determined via the desired measuring range. In the case of an absolute rotary encoder with 12-bit standard resolution:

$$4096 \text{ steps/revolution} \times 3 \text{ revolutions} = 12,288 \text{ steps}$$

This value is now entered as the "Physical impulses" parameter. The actual desired step number of 400 is entered under "Desired measuring units." The absolute rotary encoder now outputs 400 steps over a measuring range of 12,288 physical steps, i.e., 3 revolutions.

Software Limit Switch Parameters

You can program two positions such that when these positions are exceeded or not reached, the absolute rotary encoder sets bit 27 in the 32-bit process actual value to "1." The bit is set to "0" between the two positions. You can input any parameter values for the two limit switch values. However, the values must not exceed the value of the "Total measuring range" parameter.

Lower limit switch: Activate or deactivate the limit switch function and entry of the trigger measuring step in relation to the scaled value.

- Deactivated: lower limit switch is deactivated
- Activated: lower limit switch is activated

Upper limit switch: Activate or deactivate the limit switch function and entry of the trigger measuring step in relation to the scaled value.

- Deactivated: upper limit switch is deactivated
- Activated: upper limit switch is activated

Other Parameters

Velocity output unit: Set the unit for velocity output. The possible settings are:

- Steps/1000 ms
- Steps/100 ms
- Steps/10 ms
- Revolutions per minute

Commissioning mode: Activate or deactivate commissioning mode.

- Deactivated: commissioning mode is deactivated
- Activated: commissioning mode is activated

Commissioning mode is a special mode of the device that enables you to transfer parameters in addition to the preset value.



Note!

A detailed description of how to use commissioning mode can be found in the "Commissioning Mode" chapter.

Shorter diagnostics: Set shorter/longer number of diagnostic bytes.

- Yes: reduced number of 16 diagnostic bytes
- No: standard number of 57 diagnostic bytes

The standard number of 57 diagnostic bytes can lead to problems for some PROFIBUS masters. Older masters in particular are often not able to process the full number. For absolute rotary encoders, it is possible to reduce the output of diagnostic bytes to 16.

Setting the Parameters

1. Click on the desired advanced functions (1) in the **Device-specific parameters** section.

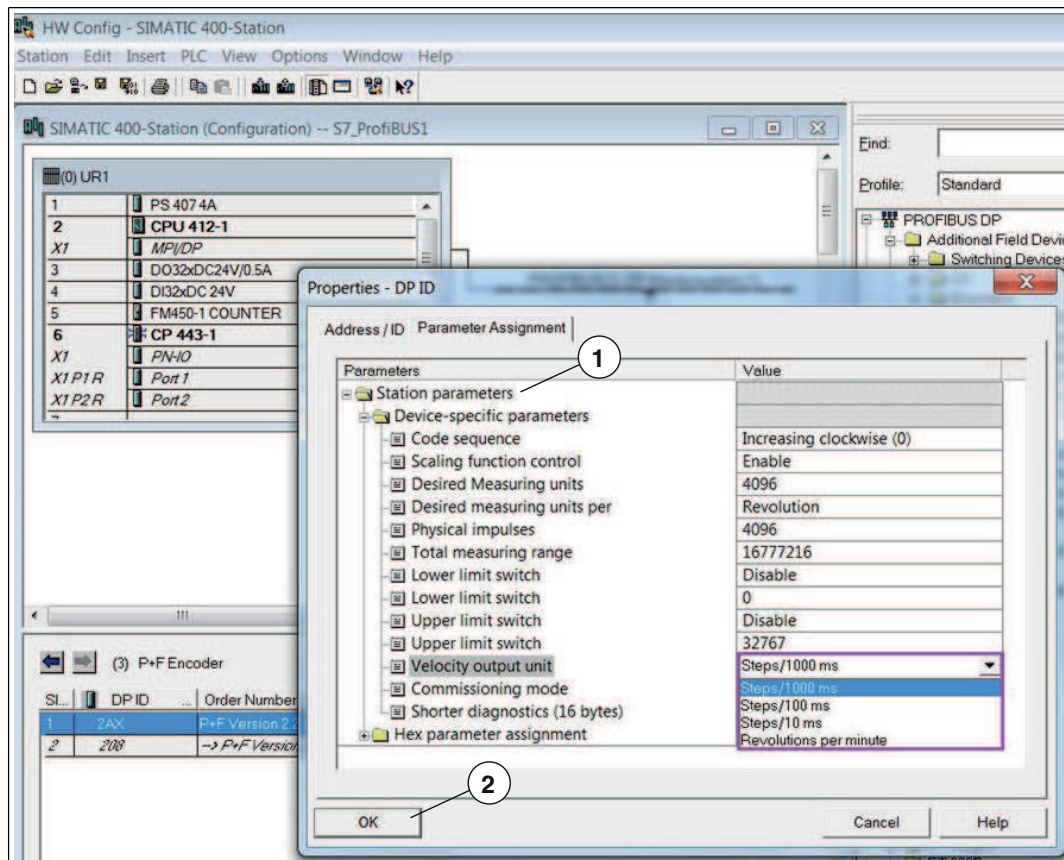

Figure 7.19

2. Adjust the relevant functions.
3. Click the OK button (3) to confirm the entry.

▶ Saving and Compiling the Station

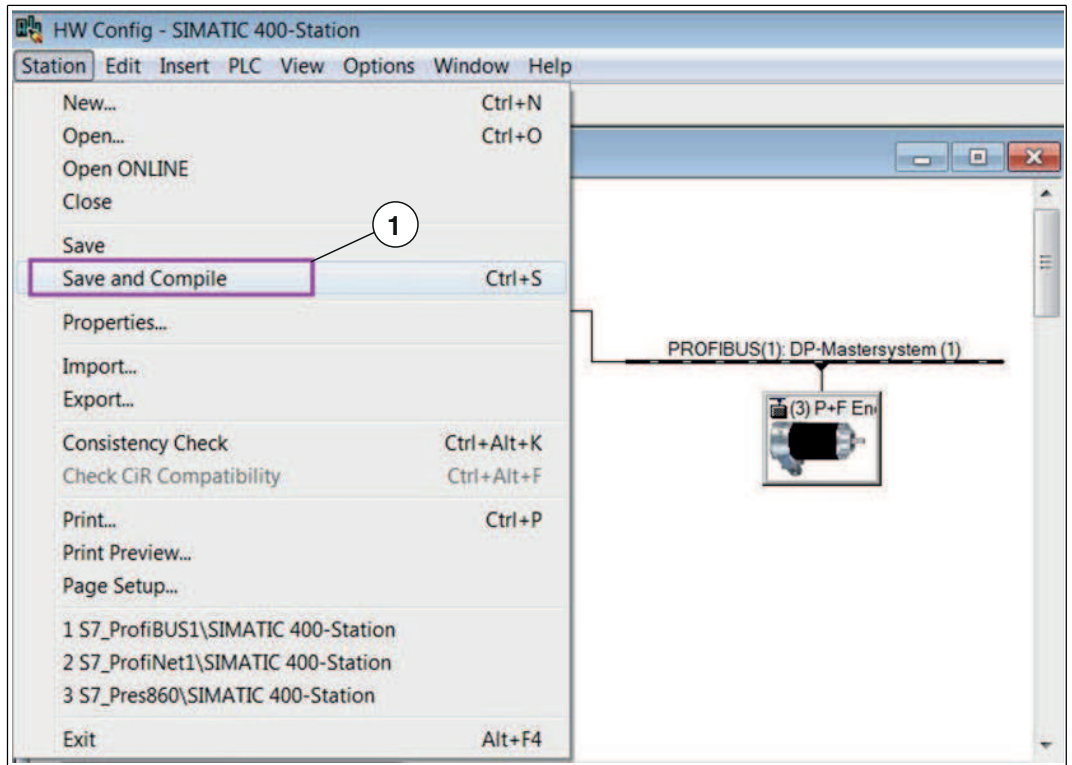

Figure 7.20

4. Once all parameters have been set, select "Station >> Save and Compile" (1).
↳ Once parameterization is complete, you must load the configuration in the controller. Continue with the "**Download to PLC Module**" chapter.

7.9 Download to PLC module



Note!

Once parameterization has been completed, you must transfer the entire hardware configuration of the project to the controller. This is performed via the **PLC** menu, "Download" command.



Transferring the Project to the Controller

Select "PLC >> Download" (1)

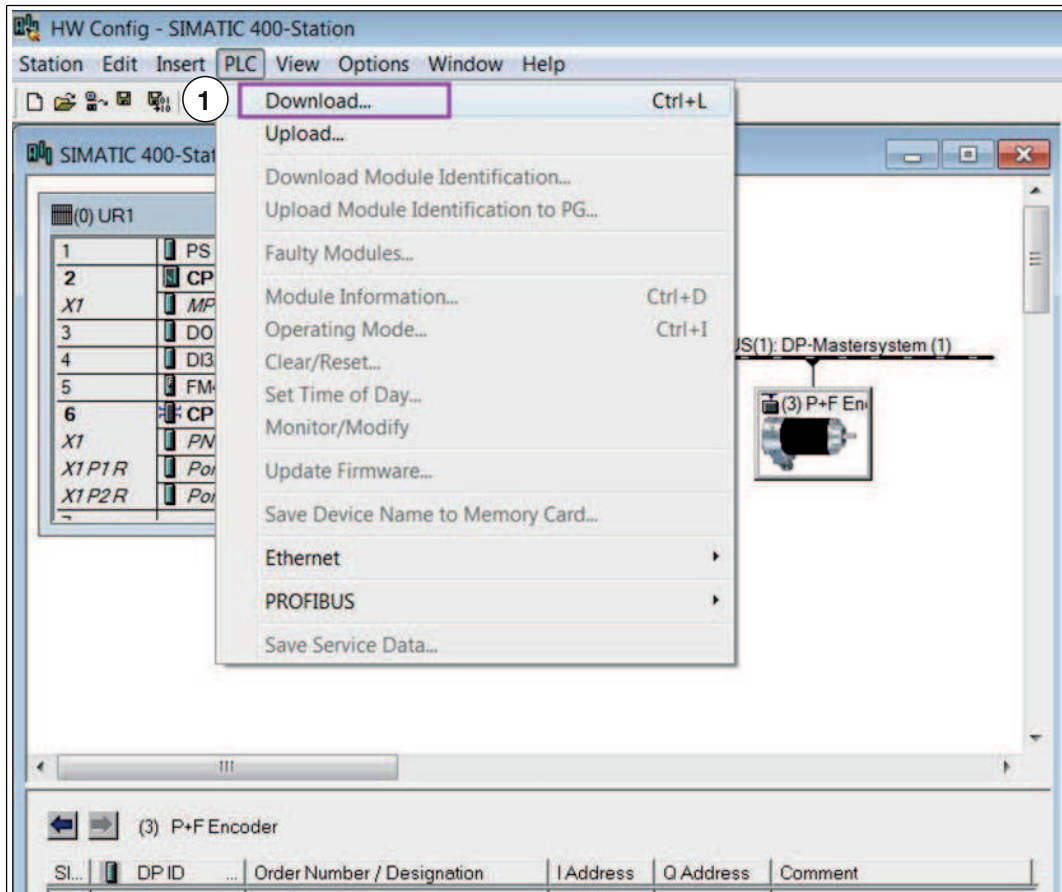

Figure 7.21

8 Commissioning Mode

8.1 Introduction

Commissioning mode is a special state of the device. This mode is available only for the P+F Version 2.1 and 2.2 device classes. When the absolute rotary encoder is switched to commissioning mode via parameter assignment, you can "teach in" a gear factor directly on the system. This means that the gear factor can be determined by moving the system directly, instead of by inputting the resolution/measuring step parameters (gear factor).

Commissioning mode also enables online modification of the counting direction, which increases the output code without having to call up the parameterization menu. If the counting direction and gear factor are modified in commissioning mode, the new values are saved in the EEPROM of the absolute rotary encoder. While commissioning mode is active, the absolute rotary encoder ignores the parameters for counting direction and scaling available in the project planning tool. Instead, the absolute rotary encoder values saved in the internal EEPROM are used.

You can also set a preset value as a reference value for the absolute rotary encoder, to adjust the zero point of the rotary encoder to the mechanical zero point of the system, for example. When the preset value is set, the actual value of the rotary encoder is set to the desired preset value. The necessary zero point shift is calculated by the absolute rotary encoder and permanently saved in the EEPROM of the device.

The absolute rotary encoder can also be permanently operated in commissioning mode. However, we recommend entering the parameters determined in commissioning mode in the project planning tool, and then using the absolute rotary encoder in normal mode (commissioning mode must be deactivated). This also enables the device to be replaced if necessary without requiring a new teach-in.

8.2 Setting the Counting Direction

Prerequisite: Commissioning mode is activated in the relevant parameter assignment menu (1).

(Bit 25 is 1)

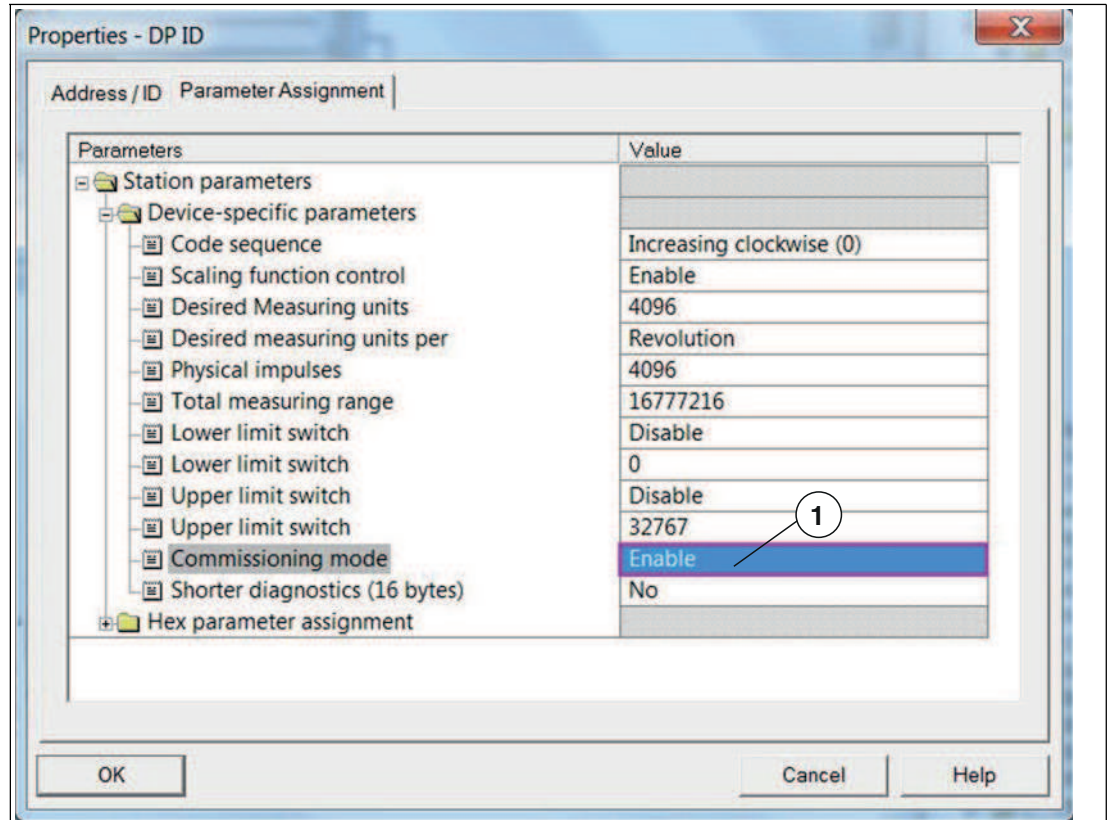

Figure 8.1

Setting the Counting Direction via Bit 28

The current counting direction relative to the direction of rotation of the shaft is displayed via bit 28 in the input word32.

- 0: absolute output position value "increasing" when the direction of rotation of the shaft is "clockwise"
- 1: absolute output position value "decreasing" when the direction of rotation of the shaft is "clockwise"

	Status bits							Data bits
	31	30	29	28	27	26	25	24 ... 0
Master -> rotary encoder	0	0	0	1	0	0	0	Changeover of the counting direction via bit 28
Rotary encoder -> master	0	0	0	0/1	0	0	1	The rotary encoder responds with the new counting direction in bit 0 and bit 28. Bit 0: 0/1
Master -> rotary encoder	0	0	0	0	0	0	0	Resetting bit 28 ends the changeover
Rotary encoder -> master	0	0	0	0/1	X	0	1	Output of the position value with modified counting direction

Table 8.1

You can change over the counting direction via bit 28 in the output word32. The configured counting direction is permanently saved in the EEPROM of the absolute rotary encoder.

Application Example

A variable table VAT_1 was created by way of illustration. The "Code sequence" control bit was defined for this example. The input word32 with example input address ED 100 and output word32 with example output address AD 100 are shown in hexadecimal and binary form.

Output status:

- Commissioning mode status bit 25 (1) is set to 1 (active)
- Counting direction status bit 28 (2) is set to 0 = counting direction increasing clockwise

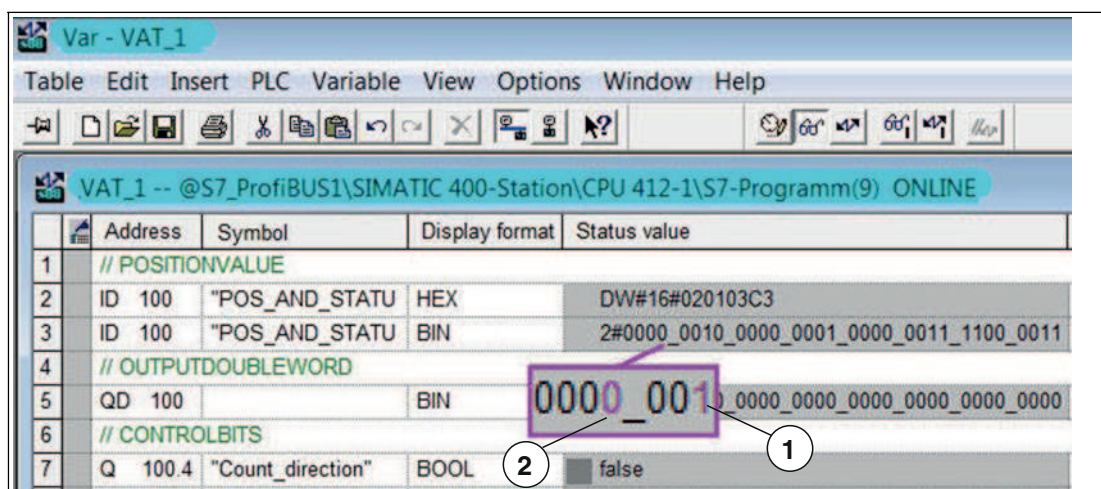

Figure 8.2

	Address	Symbol	Display format	Status value
1		// POSITIONVALUE		
2	ID 100	"POS_AND_STATU"	HEX	DW#16#12000001
3	ID 100	"POS_AND_STATU"	BIN	2#0001_0010_0000_0000_0000_0000_0001
4		// OUTPUTDOUBLEWORD		
5	QD 100		BIN	0001_001_0000_0000_0000_0000_0001
6		// CONTROLBITS		
7	Q 100.4	"Count_direction"	BOOL	true

Figure 8.3

The "Code sequence" counting direction control bit is activated from "false" to "true" (1). This sets the counting direction status bit 28 and bit 0 in the input word32 ED 100 (2) to 1. The counting direction now decreases clockwise.

After the counting direction control bit is reverted from "true" to "false," the modified counting direction is retained in the absolute rotary encoder and is not stored in the EEPROM volatile memory.

8.3 Setting the Step Number via Teach-In

Prerequisite: Commissioning mode is activated in the relevant parameter assignment menu (1).

(Bit 25 is 1)

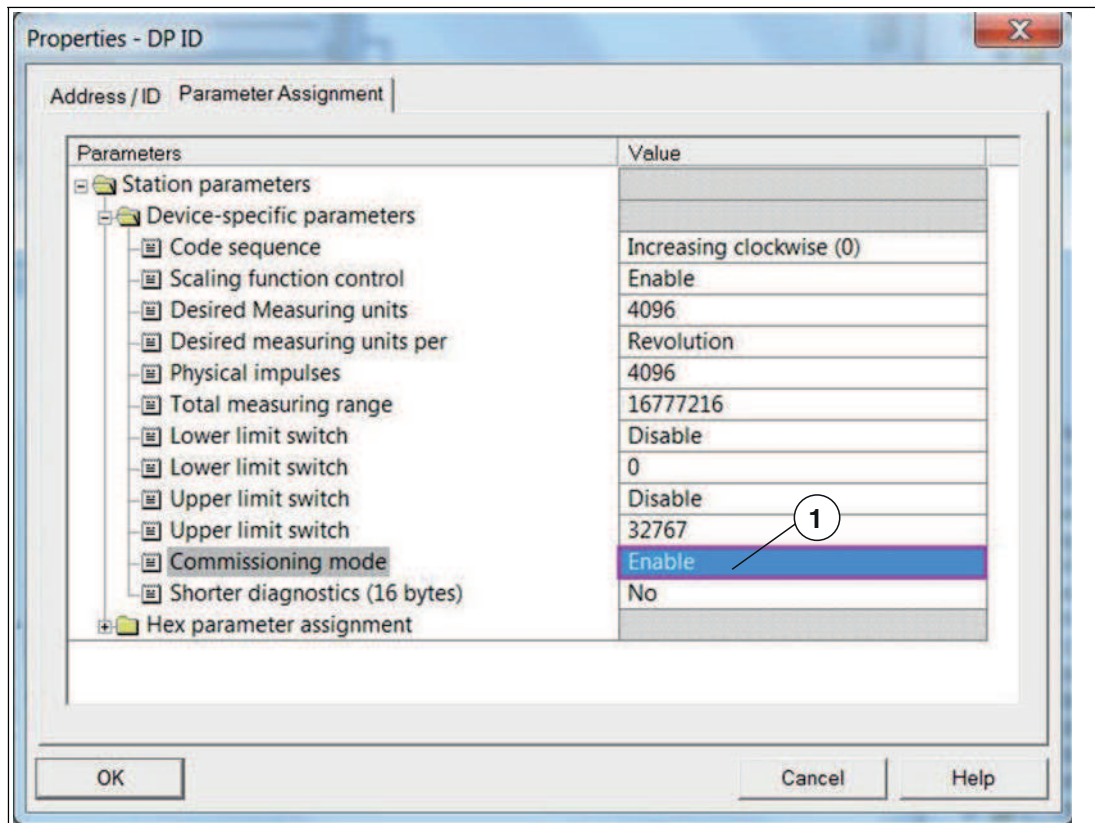

Figure 8.4

Overview of the Teach-In Process

The teach-in process consists of the following substeps:

- Move the plant to the start of the measuring range
- Start the teach-in by setting the corresponding bits in a variable table (the following table illustrates the process)

	Status bits							Data bits
	31	30	29	28	27	26	25	24 ... 0
Master -> rotary encoder	0	1	0	0	0	0	0	Start of the teach-in by setting bit 30
Rotary encoder -> master	0	1	0	X	X	0	1	Rotary encoder confirms the start of the teach-in by setting bit 30
Master -> rotary encoder	0	0	0	0	0	0	0	Reset of bit 30
Rotary encoder -> master	0	1	0	X	X	0	1	Output of the non-offset actual value (gear factor = 1, preset not active)

Table 8.2

- Move the system over the desired measuring range
- Stop the teach-in by setting bit 29 in a variable table and note the determined gear factor

	Status bits							Data bits
	31	30	29	28	27	26	25	24 ... 0
Master -> rotary encoder	0	0	1	0	0	0	0	Stopping of the teach-in by setting bit 29, and transferring the desired step number via the traveled measuring range
Rotary encoder -> master	0	1	1	X	X	0	1	Transfer of the total resolution for a new gear factor as a binary value. Must be noted down and converted into a decimal value for the project planning tool.
Master -> rotary encoder	0	0	0	0	0	0	0	Reset of bit 29
Rotary encoder -> master	0	0	0	X	X	0	1	Output of the actual value that has been offset with the new gear factor

Table 8.3

- Input of the determined gear factor in the project planning tool in parameterization.

Application Example

A variable table VAT_1 was created by way of illustration. The teach-in process is described in detail by means of an example using this variable table. The "Teach_In_Start" and "Teach_In_Stop" control bits were defined for this example. The input word32 with example input address ED 100 and output word32 with example output address AD 100 are shown in hexadecimal and binary form.

Starting Teach-In



Note!

The gear factor is set to 1 internally and the zero point shift is deleted.

1. Move the plant to the start of the measuring range.

Address	Symbol	Display format	Status value
// POSITIONVALUE AND STATUSBITS			
ID 100	"POS_AND_STATU"	HEX	DW#16#43B180D0
ID 100	"POS_AND_STATU"	BIN	2#0100_0011_1011_0001_1000_0000_1101_0000
// OUTPUTDOUBLEWORD			
QD 100		BIN	0100 000_0000_0000_0000_0000_0000_0000_0000
QD 100		DEC	1824
// CONTROLBITS			
Q 100.5	"Teach_In_Stop"	BOOL	false
Q 100.6	"Teach_In_Start"	BOOL	true

Figure 8.5

2. Start the teach-in process by setting the "Teach_In_Start" control bit (1) from "false" to "true."

↳ The absolute rotary encoder confirms this by setting status bit 30 (2). The absolute rotary encoder now begins the measurement for the definition of the gear factor internally.

3. After confirmation, revert the "Teach_In_Start" control bit (4) back from "true" to "false."

Address	Symbol	Display format	Status value
// POSITIONVALUE AND STATUSBITS			
ID 100	"POS_AND_STATU"	HEX	DW#16#43B180D0
ID 100	"POS_AND_STATU"	BIN	2#0100_0011_1011_0001_1000_0000_1101_0000
// OUTPUTDOUBLEWORD			
QD 100		BIN	2#0000_0000_0000_0000_0000_0000_0000_0000
QD 100		DEC	L#0
// CONTROLBITS			
Q 100.5	"Teach_In_Stop"	BOOL	false
Q 100.6	"Teach_In_Start"	BOOL	false

Figure 8.6

↳ The absolute rotary encoder outputs the non-offset actual value in bit 0 to bit 24 (3) (gear factor = 1, preset not active).



Stopping Teach-In



Note!

After moving the plant over the measuring range, you must input the step number desired for the measuring range before setting the stop command for the teach-in. You must ensure that the physical resolution is not exceeded. Positive and negative direction of rotation, as well as if the zero point is exceeded, is automatically taken into consideration. The measuring range covered must not exceed 2047 revolutions.

1. Move the plant over the measuring range.

Address	Symbol	Display format	Status value	Modify value
// POSITIONVALUE AND STATUSBITS				
ID 100	"POS_AND_STATU	HEX	DW#16#43B46FE3	
ID 100	"POS_AND_STATU	BIN	2#0100_0011_1011_0100_0110_1111_1110_0011	
// OUTPUTDOUBLEWORD				
QD 100		BIN	2#0000_0000_0000_0001_1000_0110_1010_0000	
QD 100		DEC	L#100000	L#100000
// CONTROLBITS				
Q 100.5	"Teach_In_Stop"	BOOL	false	
Q 100.6	"Teach_In_Start"	BOOL	false	

Figure 8.7

2. Input the desired step number as a total resolution (1); in this example it is 100000.

Address	Symbol	Display format	Status value	Modify value
// POSITIONVALUE AND STATUSBITS				
ID 100	"POS_AND_STATU	HEX	DW#16#E30A4907	
ID 100	"POS_AND_STATU	BIN	2#1110_0011_0000_1010_0100_1001_0000_0111	
// OUTPUTDOUBLEWORD				
QD 100		BIN	2#0010_0000_0000_0001_1000_0110_1010_0000	
QD 100		DEC	L#536970912	L#100000
// CONTROLBITS				
Q 100.5	"Teach_In_Stop"	BOOL	true	
Q 100.6	"Teach_In_Start"	BOOL	false	

Figure 8.8

3. Stop the teach-in process by setting the "Teach_In_Stop" control bit (3) from "true" to "false."

↳ The absolute rotary encoder outputs the total resolution (2) in bit 0 to bit 24 with the newly offset gear factor. Note this binary value and convert the binary value into a decimal value. Input this value later for normal operation in the parameterization of the project planning tool. This means that the absolute rotary encoder can be replaced without a new teach-in.

4. Revert the "Teach_In_Stop" control bit (5) from "true" to "false."

	Address	Symbol	Display format	Status value	Modify value
1	// POSITIONVALUE AND STATUSBITS				
2	ID 100	"POS_AND_STATU"	HEX	DW#16#021FAD78	
3	ID 100	"POS_AND_STATU"	BIN	2#0000_0010_0011_1010_1101_0111_1000	
4	// OUTPUTDOUBLEWORD				
5	QD 100		BIN	0000	
6	QD 100		DEC	L#100000	
7	// CONTROLBITS				
8	Q 100.5	"Teach_In_Stop"	BOOL	false	
9	Q 100.6	"Teach_In_Start"	BOOL	false	

Figure 8.9

↳ This ends the teach-in operation and bit 29 and bit 30 (4) are reset accordingly.

Entering Teach-In Results in the Project Planning Tool



Note!

We recommend entering the parameters determined in commissioning mode in the project planning tool, and then using the absolute rotary encoder in normal mode (commissioning mode must be deactivated). The absolute rotary encoder can therefore be replaced without a new teach-in process. To do so, you must input the value determined during the teach-in, and change the setting in the "Desired measuring units per" parameter field to "Maximal total measuring range." During parameterization, you must also ensure that the same direction of rotation as for the teach-in is entered in commissioning mode. You can then deactivate commissioning mode. The rotary encoder is now operated in normal mode.

The following example describes calling up and entering values in the "Parameter Assignment" menu for manufacturer-specific device class P+F Version 2.1 (1).

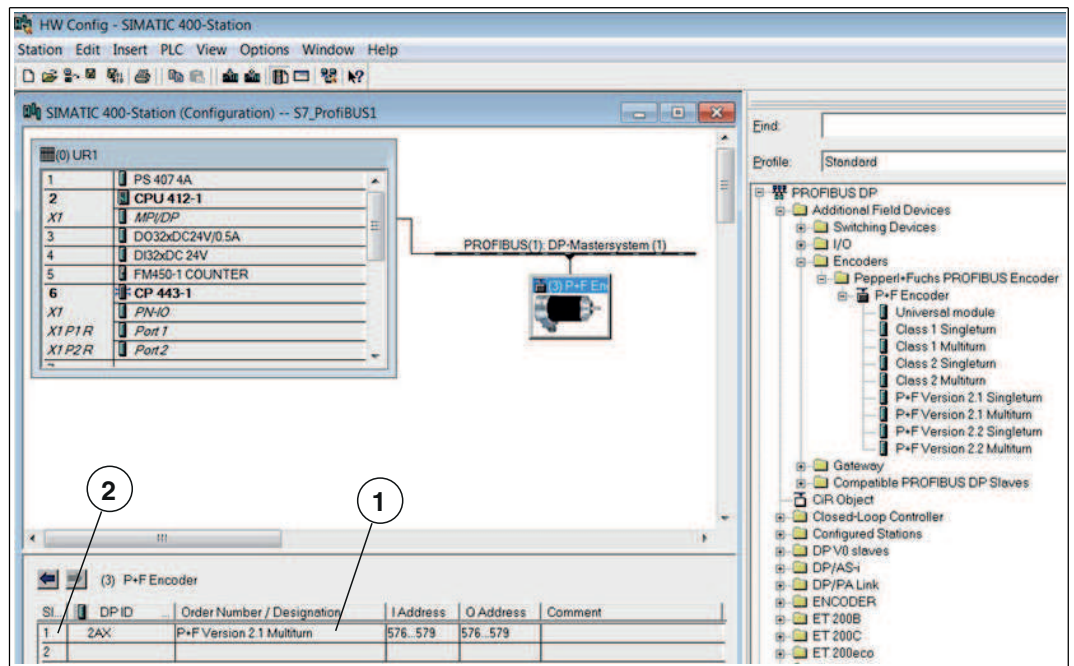

Figure 8.10

5. Double-click on **Slot 1** in the table (2).
↳ The **Properties - DP ID** menu is displayed.
6. Click the **Parameter Assignment** tab to call up the basic functions to be adjusted.

7. Click on the desired advanced functions (1) in the **Device-specific parameters** section.

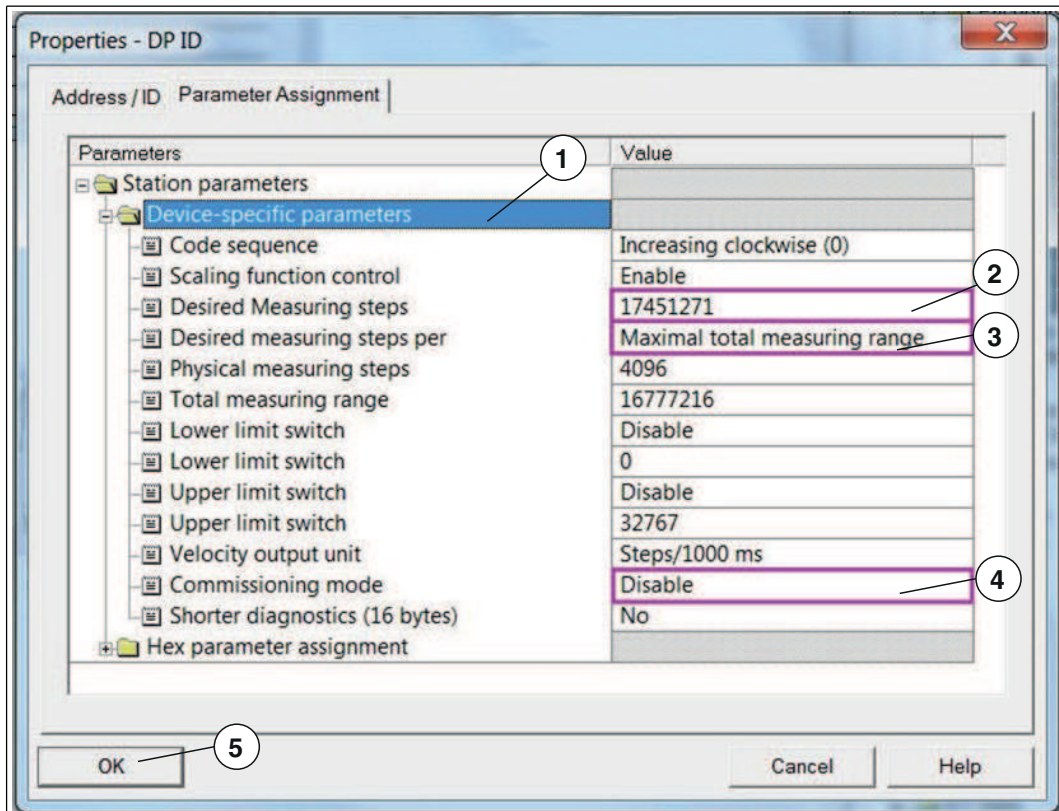

Figure 8.11

8. Input the determined total resolution with the newly offset gear factor (2). In this example 17451271.
9. Set the "Desired measuring units per" parameter field (3) to "Maximal total measuring range."
10. Deactivate commissioning mode (4).
11. Click the OK button (5) to confirm the entry.

8.4 Setting the Preset Value

Prerequisite: Commissioning mode is activated in the relevant parameter assignment menu (1).

(Bit 25 is 1)

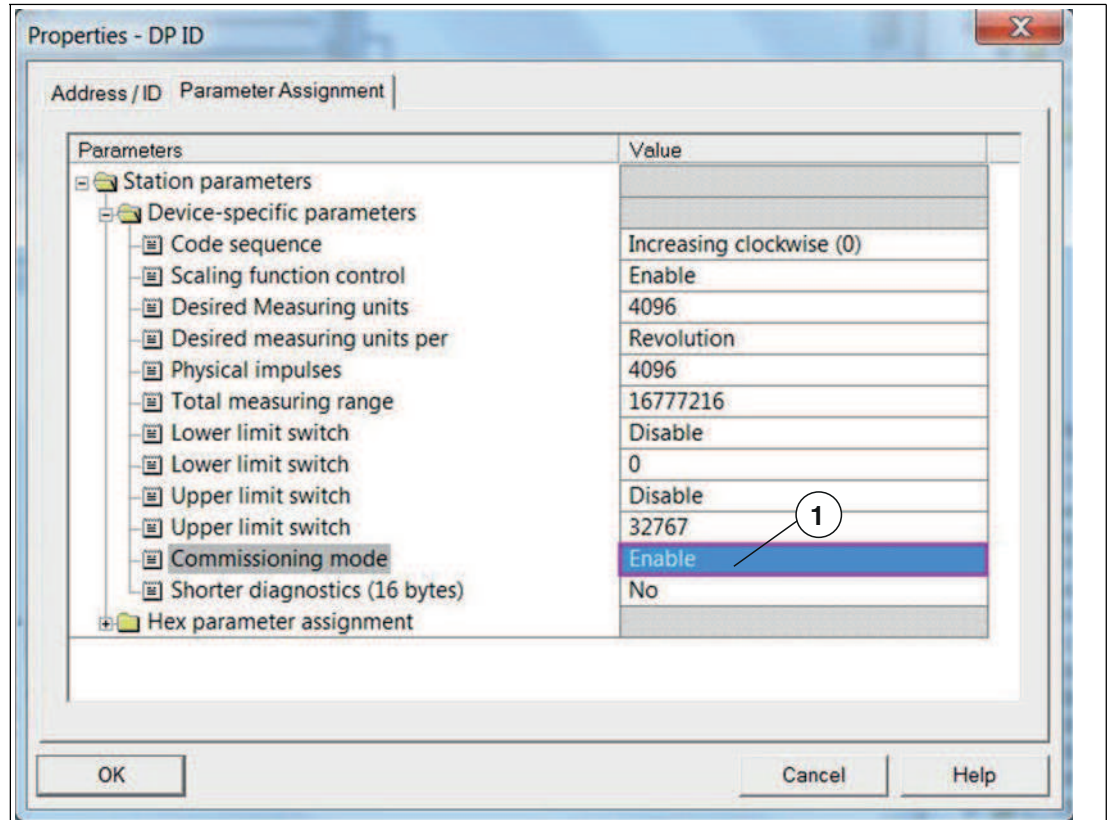

Figure 8.12

Overview of Setting the Preset Value

The operations listed in the following table are performed when setting the preset value. The preset value is set in commissioning mode for the manufacturer-specific device classes P+F Version 2.1 and 2.2, and in normal mode for device Class 2 (see chapter "Device Profile in Accordance with PROFIBUS Encoder Profile," section "Data Exchange in Normal Operation").

Before setting the preset value, the system must be moved to the desired reference point and must then be at a standstill.

	Status bits							Data bits
	31	30	29	28	27	26	25	24 ... 0
Master -> rotary encoder	1	0	0	0	0	0	0	Transfer of the desired value for the preset value
Rotary encoder -> master	1	0	0	0	0	0	1	Status bit confirms the configuration of the preset value. The desired preset value is transferred as the process actual value.
Master -> rotary encoder	0	0	0	0	0	0	0	Reset of bit 31
Rotary encoder -> master	0	0	0	0	0	0	1	Status bit confirmed when bit 31 = 0

Table 8.4

Application Example

A variable table VAT_1 was created by way of illustration. Setting the preset value is described in detail by means of an example using this variable table. The "preset" control bit was defined for this example. The input word32 with example input address ED 100 and output word32 with example output address AD 100 are shown in hexadecimal and binary form.

Setting the Preset Value

Note!

The system must be at a standstill in order to set the preset value, as the current actual value of the rotary encoder is offset.

1. Move the system to the desired reference point, such as the zero point of the system.

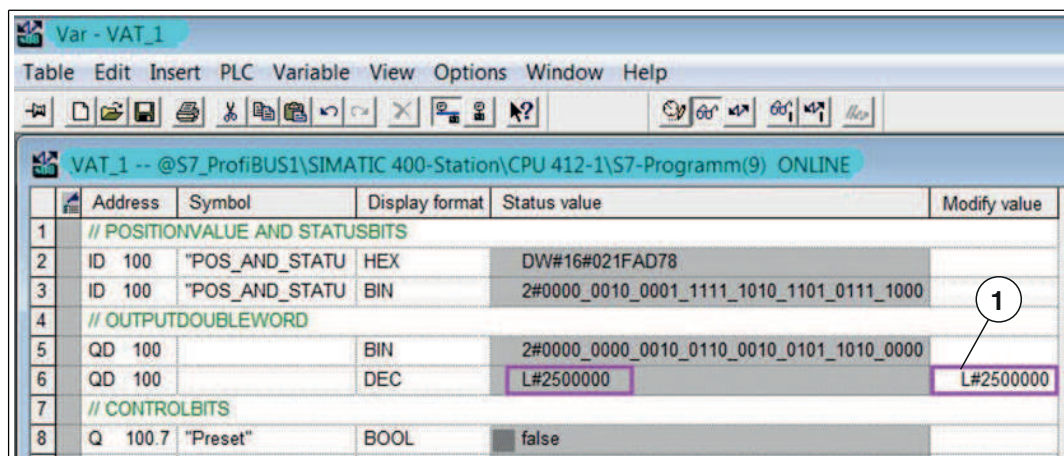

Figure 8.13

2. Enter the desired preset value as a decimal number (1), here 2500000

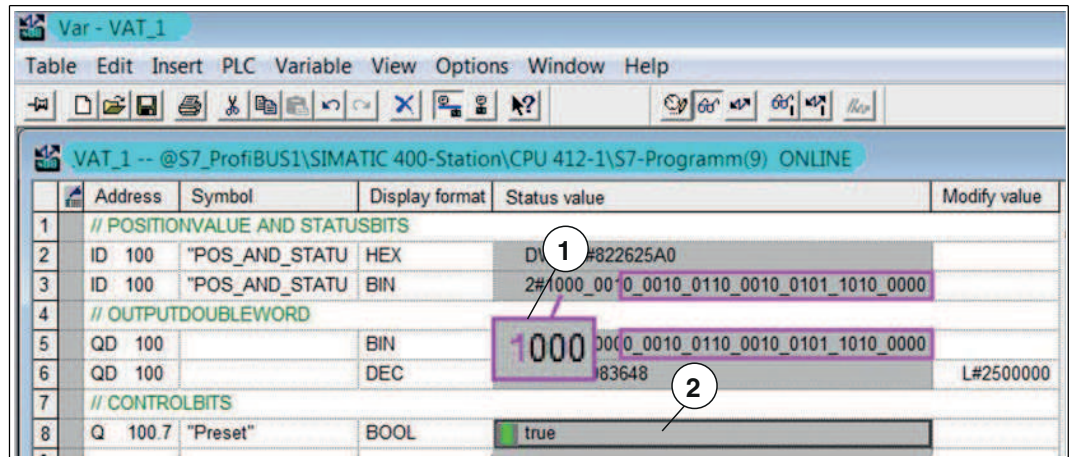

Figure 8.14

3. Change the "Preset" control bit (2) from "false" to "true."

↳ When the control bit is set, the value entered is applied as the current output value of the absolute rotary encoder. Transfer of the preset value is confirmed by setting bit 31 (1). The absolute rotary encoder calculates the necessary zero point shift or the offset value, and saves this value permanently in the EEPROM of the device.

4. Following confirmation, change the "Preset" control bit (2) back from "true" to "false."

↳ After reverting the control bit (false), bit 31 of the input data is also reset.

9 Diagnostic Messages

9.1 Overview

In "DDL_M_Slave_DIAG" operating mode, and on request by the master, diagnostic data from the absolute rotary encoder is transferred to the master. The standard number of diagnostic bytes is 57. For the P+F Version 2.1 and P+F Version 2.2 device classes, a reduced diagnosis with 16 bytes can also be configured via the parameterization. For device Class 1, the number of diagnostic bytes is 16.

The diagnostic data is output in accordance with the specifications of the PROFIBUS standard (byte 1 ... 6) and in accordance with the device profile (byte 7 onward).

Diagnostics	Data Type	Diagnosis Byte Number	Device Class
Station status 1 (see PROFIBUS standard)	Byte	1	1
Station status 2 (see PROFIBUS standard)	Byte	2	1
Station status 3 (see PROFIBUS standard)	Byte	3	1
Diagnosis master address	Byte	4	1
PNO ident number	Byte	5,6	1
Extended Diagnostic Head	Byte string	7	1
Alarm signals	Byte string	8	1
Operating state	Byte string	9	1
Rotary Encoder Type	Byte string	10	1
Steps per revolution (hardware)	Unsigned 32	11 ... 14	1
Number of revolutions (hardware)	Unsigned 16	15, 16	1
Further alarm signals	Byte string	17	2
Supported alarm signals	Byte string	18, 19	2
Warning messages	Byte string	20, 21	2
Supported warnings	Byte string	22, 23	2
Profile Version	Byte string	24, 25	2
Software Version	Byte string	26, 27	2
Operating Time	Unsigned 32	28 ... 31	2
Zero Point Shift	Unsigned 32	32 ... 35	2
Manufacturer-specific: offset value	Unsigned 32	36 ... 39	2
Parameterized steps per revolution	Unsigned 32	40 ... 43	2
Parameterized total resolution	Unsigned 32	44 ... 47	2
Serial Number	ASCII string	48 ... 57	2

9.2 Displaying Diagnostic Messages with the Project Planning Tool

You can also display diagnostic information for the connected PROFIBUS absolute rotary encoder "online" via the project planning tool in the HEX code.



Reading Out Diagnostic Data

1. Click on the **PLC** menu, **Module Information** command (1).

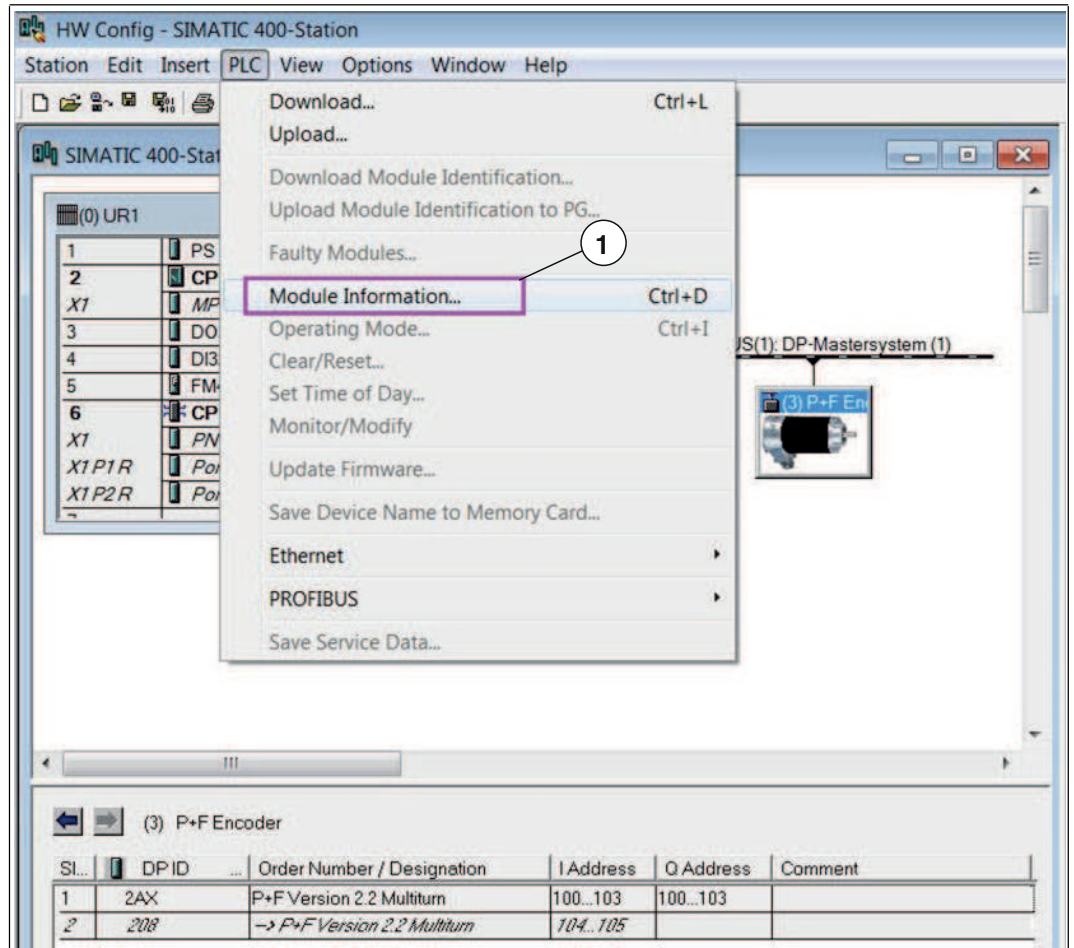

Figure 9.1

2. Click on the **DP Slave Diagnostics** tab (1) and then on the **Hex. Format** command (2).

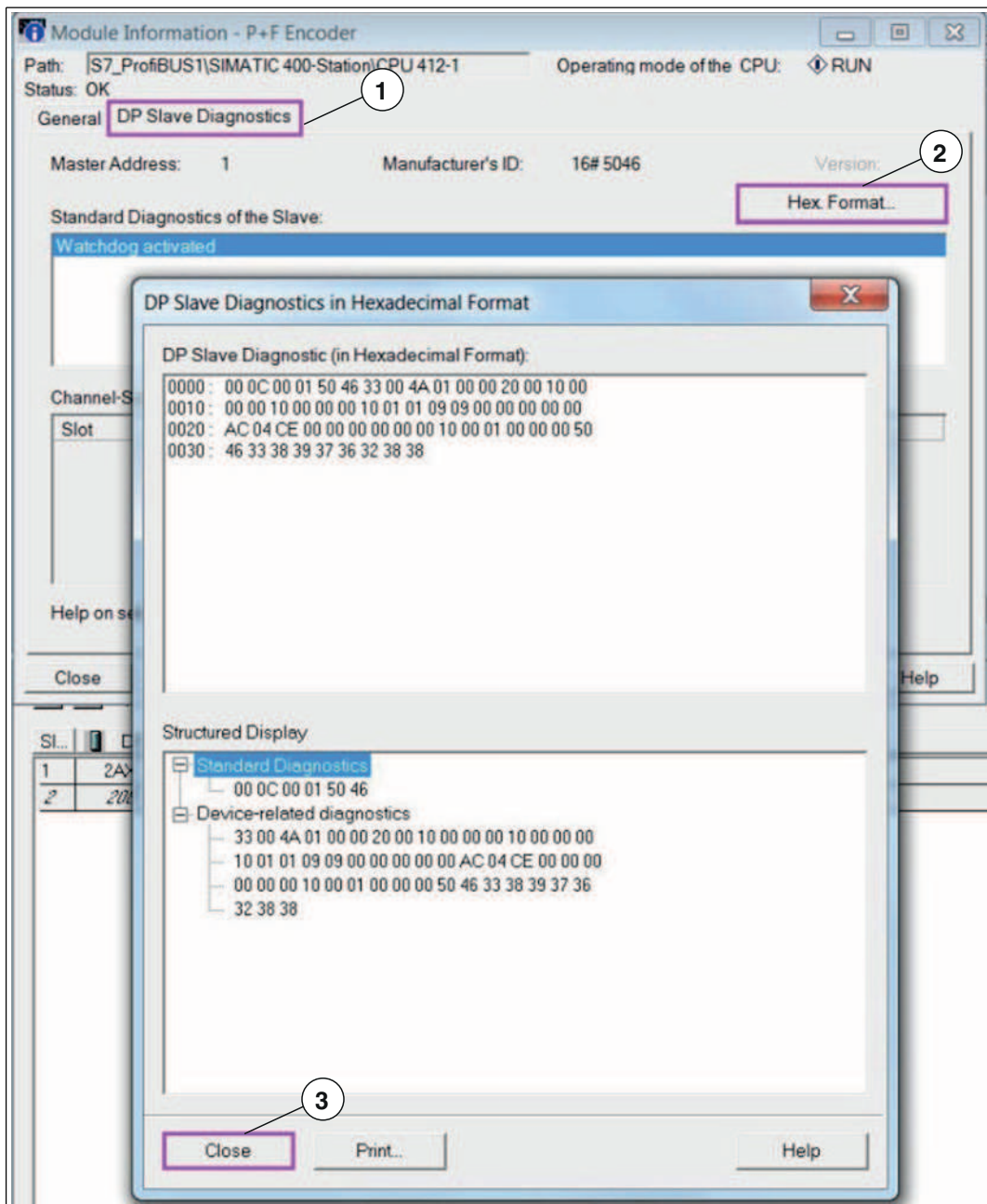

Figure 9.2

↳ The project planning tool displays current diagnostic information for the absolute rotary encoder.

3. Click the Close button (3) to close the display.

9.3 Supported Diagnostic Messages

Individual diagnostic information is described in more detail in the following sections.

Extended Diagnostic Head

Diagnostic byte 7 contains the length of the extended diagnosis (including the diagnosis head itself).

Memory Error

Diagnostic byte 8, bit 4 indicates whether a memory error has occurred.

In this case, a memory error signifies that the EEPROM of the absolute rotary encoder is no longer functioning correctly. A permanent save, e.g. of the zero point shift, is no longer ensured.

Bit	Definition	0	1
4	Memory error (defect in the EEPROM)	No	Yes

Table 9.1

Operating state

The operating parameters set via the parameterization can be retrieved via diagnostic byte 9.

Bit	Definition	0	1
0	Direction of rotation	Clockwise cw	Counterclockwise ccw
1	Class 2 functionality	Off	On
2	Diagnostic routine	Off	On
3	Scaling function	Off	On

Table 9.2

Rotary Encoder Type

The rotary encoder type can be retrieved via diagnostic byte 10.

Byte	Definition
0	Singleturn rotary encoder
1	Multiturn rotary encoder

Table 9.3

Singleturn Resolution

The physical steps per revolution of the rotary encoder are specified in diagnostic bytes 11 ... 14.

Number of Revolutions

The physical number of distinguishable revolutions of the rotary encoder is determined via diagnostic bytes 15 and 16.

The default values are:

- 1 for singleturn rotary encoders
- 4096 for multiturn rotary encoders

Operating Time Warning

The warning message if the operating time is exceeded is displayed in diagnostic byte 20, bit 4. After 10^5 hours, bit 4 is set to 1.

Profile Version

The profile version of the rotary encoder is specified in diagnostic bytes 24 and 25.

	Revision No.	Index
Byte	24	25
Bit	15 ... 8	7 ... 0
Data	$2^7 \dots 2^0$	$2^7 \dots 2^0$

Table 9.4

Software Version

The software version of the rotary encoder is specified in diagnostic bytes 26 and 27.

	Revision No.	Index
Byte	26	27
Bit	15 ... 8	7 ... 0
Data	$2^7 \dots 2^0$	$2^7 \dots 2^0$

Table 9.5

Operating Time

The operating time of the device is recorded in diagnostic bytes 28 ... 31. If the device has supply voltage, the "operating time" value is saved in the rotary encoder every 6 minutes in steps of 0.1 h.

Zero Point Shift

The zero point shift is output in diagnostic bytes 32 ... 35.

Parameterized Resolution

The parameterized steps per revolution is stored in diagnostic bytes 40 ... 43. This value is valid only if the gear factor was calculated via the "Steps per revolution" setting in the **Parameter Assignment** menu.

Serial Number

In accordance with the encoder profile, diagnostic bytes 48 ... 57 are reserved for a serial number.

FACTORY AUTOMATION – SENSING YOUR NEEDS



Worldwide Headquarters

Pepperl+Fuchs GmbH
68307 Mannheim · Germany
Tel. +49 621 776-0
E-mail: info@de.pepperl-fuchs.com

USA Headquarters

Pepperl+Fuchs Inc.
Twinsburg, Ohio 44087 · USA
Tel. +1 330 4253555
E-mail: sales@us.pepperl-fuchs.com

Asia Pacific Headquarters

Pepperl+Fuchs Pte Ltd.
Company Registration No. 199003130E
Singapore 139942
Tel. +65 67799091
E-mail: sales@sg.pepperl-fuchs.com

www.pepperl-fuchs.com

 **PEPPERL+FUCHS**
SENSING YOUR NEEDS