

MANUAL

OHV2000-F22-B15
Handheld Reader



CE

With regard to the supply of products, the current issue of the following document is applicable: The General Terms of Delivery for Products and Services of the Electrical Industry, published by the Central Association of the Electrical Industry (Zentralverband Elektrotechnik und Elektroindustrie (ZVEI) e.V.) in its most recent version as well as the supplementary clause: "Expanded reservation of proprietorship"

1	Introduction.....	5
1.1	Content of this Document	5
1.2	Target Group, Personnel.....	5
1.3	Symbols Used	6
2	Product Description	7
2.1	Use and Application.....	7
2.2	Indicators and Operating Elements	8
2.3	Feedback	8
2.4	Scope of Delivery	9
2.5	Accessories	9
2.6	Storage and Disposal	9
3	Installation.....	10
3.1	Inserting and Removing the Battery	10
3.2	Mounting the Charger and Charging the Handheld Reader	10
3.3	Installing Vision Configurator	11
3.4	Installing Device Drivers	12
4	Configuration	13
4.1	Switching On the Handheld Reader	13
4.2	Selecting the Operating Mode	13
4.2.1	Docking Mode.....	13
4.2.2	Bluetooth Mode	14
4.2.3	Tablet Mode	14
4.2.4	Configuration Mode	15
4.2.5	Keyboard Layout.....	16
4.3	Configuring the Handheld Reader.....	17

4.4	Configuration Process Using Vision Configurator.....	17
4.4.1	Layout of Application Window	18
4.4.2	Image Display.....	19
4.4.3	Device Data	19
4.4.4	Test Statistics.....	20
4.4.5	Image Transmission	20
4.4.6	File Transmission.....	21
4.4.7	1-D Codes.....	22
4.4.8	2-D Codes.....	23
4.4.9	DPM Codes.....	24
4.4.10	Sensor Settings.....	25
4.4.11	Decoding Options	26
4.4.12	Read Result	27
4.4.13	Script.....	28
4.4.14	Edited Parameters	33
4.5	Configuration with Control Codes	34
4.5.1	Operation	34
4.5.2	Read Operation	36
4.5.3	Data Processing	39
4.5.4	Data Transfer	40
4.5.5	Restarting and Clearing.....	42
4.5.6	Setting the DPM Mode	43
4.5.7	Code Types	44
4.6	Reading Firmware Version and Serial Number	51
5	Operation.....	52
5.1	Reading Codes	52
6	Maintenance.....	53
7	Troubleshooting.....	54

1 Introduction

1.1 Content of this Document

This document contains information required to use the product in the relevant phases of the product life cycle. This may include the following:

- Product identification
- Delivery, transport, and storage
- Assembly and installation
- Commissioning and operation
- Maintenance and repair
- Troubleshooting
- Dismounting
- Disposal

The documentation comprises the following parts:

- Present document
- Datasheet

In addition, the documentation may comprise the following parts, if applicable:

- EC-Type Examination Certificate
- EC Declaration of Conformity
- Attestation of conformity
- Certificates
- Control drawings
- Other documents

1.2 Target Group, Personnel

Responsibility for planning, assembly, commissioning, operation, maintenance, and dismounting lies with the plant operator.

Only appropriately trained and qualified personnel may carry out mounting, installation, commissioning, operation, maintenance, and dismounting of the product. The personnel must have read and understood the instruction manual and the further documentation.

Prior to using the product make yourself familiar with it. Read the document carefully.



1.3 Symbols Used

This document contains symbols for the identification of warning messages and of informative messages.

Warning Messages

You will find warning messages, whenever dangers may arise from your actions. It is mandatory that you observe these warning messages for your personal safety and in order to avoid property damage.

Depending on the risk level, the warning messages are displayed in descending order as follows:



Danger!

This symbol indicates an imminent danger.

Non-observance will result in personal injury or death.



Warning!

This symbol indicates a possible fault or danger.

Non-observance may cause personal injury or serious property damage.



Caution!

This symbol indicates a possible fault.

Non-observance could interrupt the device and any connected systems and plants, or result in their complete failure.

Informative Symbols



Note!

This symbol brings important information to your attention.



Action

This symbol indicates a paragraph with instructions. You are prompted to perform an action or a sequence of actions.

2 Product Description

2.1 Use and Application



Caution!

Irritation caused by optical radiation

The optical unit on the handheld reader is equipped with very bright LEDs that can cause irritation in dark environments.

Do not point the handheld reader at people.

Do not look directly into the optical unit on the handheld reader.

The OHV2000 handheld is a compact handheld reader for all common 1-D and 2-D codes applied directly to the surface of a product. For example, the code may have been etched, printed, or laser-engraved on the housing.

Special technology to prevent glare allows the device to accurately read codes on highly reflective surfaces. With its patented dual lens and a resolution of 1.2 million pixels, it can read both small and large codes from a wide range of distances. A different-colored target projection makes it easier to see the relevant code. Feedback comes in the form of a visual or audible signal or a vibration.

Using the Vision Configurator software, rule sets can be created for formatting read results without the need for extensive programming work. This facilitates integration into ERP systems. The read data is transferred via the Bluetooth interface or by plugging the handheld reader into the charger. With its robust housing and IP65 protection, the handheld reader is suitable for outdoor use.

Type designations: **OHV2000-F221-B15**



The device is only approved for appropriate and intended use. Ignoring these instructions will void any warranty and absolve the manufacturer from any liability.

Use the device only within the specified ambient and operating conditions.

Protection of the personnel and the plant is not ensured if the device is not used according to its intended use.

2.2 Indicators and Operating Elements

OHV2000-F221

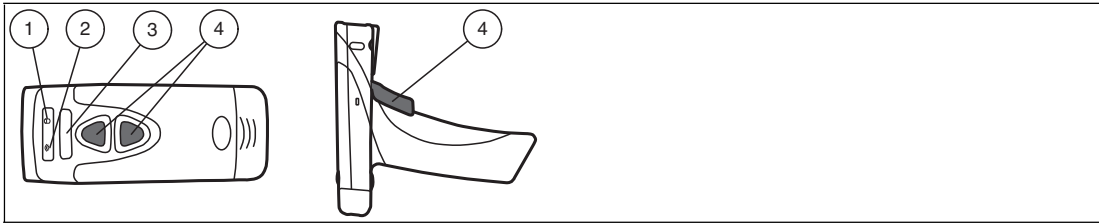

- 1 Memory
- 2 Bluetooth connection
- 3 Function indicator
- 4 Trigger buttons

2.3 Feedback

Action	LED	Audible signal	Vibration
Handheld reader successfully switched on	The function indicator on the handheld reader briefly lights up red then briefly lights up green.	Single audible signal	Vibrates once
Handheld reader ready	LEDs are off.	No audible signal	No vibration
Code reading successful	The function indicator on the handheld reader briefly lights up green. If a Bluetooth connection is activated, the Bluetooth connection on the charger flashes blue during data transfer.	Single audible signal	Vibrates once
Code reading failed	Bluetooth connection flashes green four times.	Four audible signals	Vibrates four times
Configuration code reading successful	The function indicator on the handheld reader briefly lights up green.	Two audible signals	Vibrates twice
Configuration code reading failed Configuration code not permitted	The function indicator on the handheld reader lights up twice.	Five audible signals	Vibrates five times
The handheld reader memory is full	Memory flashes five times per second. See chapter 4.5.5	No audible signal	No vibration

Action	LED	Audible signal	Vibration
Connection between charger and PC successfully established No Bluetooth connection between charger and handheld reader	The Bluetooth connection on the charger flashes blue.	No audible signal	No vibration
Connection between charger and PC successfully established Bluetooth connection between charger and handheld reader successfully established	The Bluetooth connection on the charger lights up blue. The Bluetooth connection on the handheld reader lights up green.	Single audible signal	Vibrates once

2.4 Scope of Delivery

Check the packaging and contents for damage.

Check if you have received every item and if the items received are the ones you ordered.

- Handheld reader
OHV2000-F221-B15
- Lithium-ion battery, 1300 mAh
OHV-BAT
- Quick reference guide

2.5 Accessories

Designation	Description
OHV-CHARGER-B15	Charging station for OHV200 handheld readers with integrated Bluetooth modem incl. USB-G-1M-PVC-ABG-USBB-G connection cable The connection cable can also be ordered separately later on.
OHV-BAT	1300 mAh lithium-ion battery for OHV200 handheld readers
OHV-BAT-CHARGER	Charger for lithium-ion batteries
Vision Configurator	Configuration software for camera-based sensors When using OHV handheld readers, you can download the software free of charge from www.pepperl-fuchs.com .

2.6 Storage and Disposal

Keep the original packaging. Always store and transport the device in the original packaging.

Store the device in a clean and dry environment. The permitted ambient conditions must be considered, see datasheet.

Disposing of device, packaging, and possibly contained batteries must be in compliance with the applicable laws and guidelines of the respective country.



3 Installation

3.1 Inserting and Removing the Battery



Inserting the Battery

1. Insert the battery into the handheld reader.

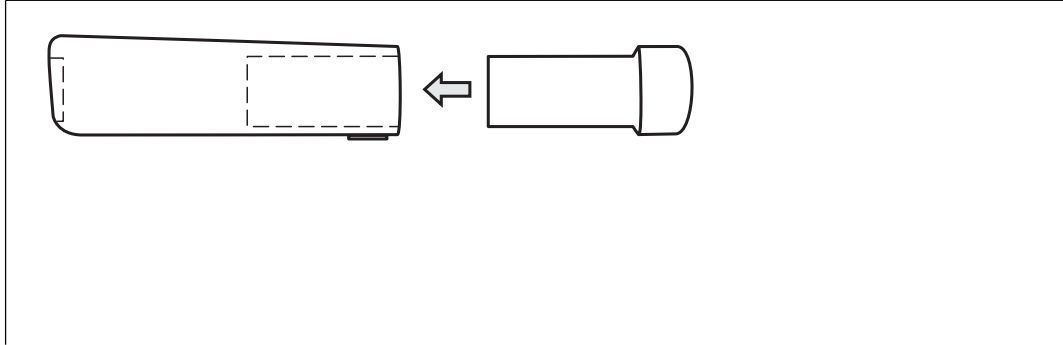

2. Make sure that the battery audibly snaps into place.



Removing the Battery

1. Move the locking device on the bottom of the handheld reader in the direction of the arrow.

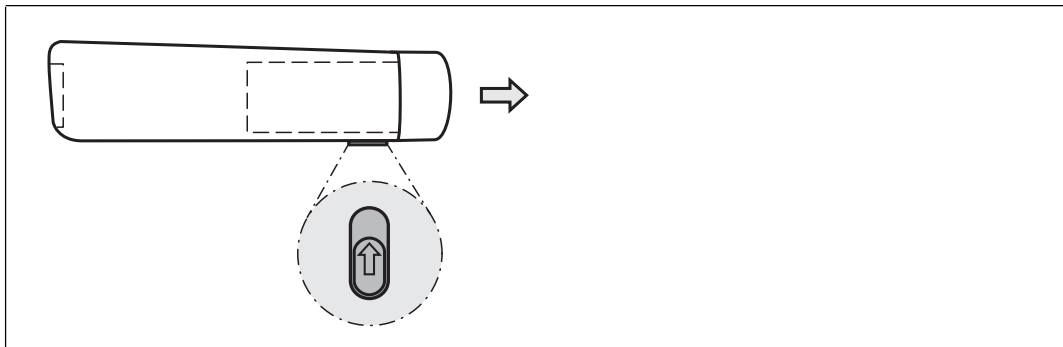

2. Remove the battery.

3.2 Mounting the Charger and Charging the Handheld Reader



Mounting the Charger

1. Insert the USB cable or the plug of the plug-in power supply into the socket provided on the bottom of the charger.

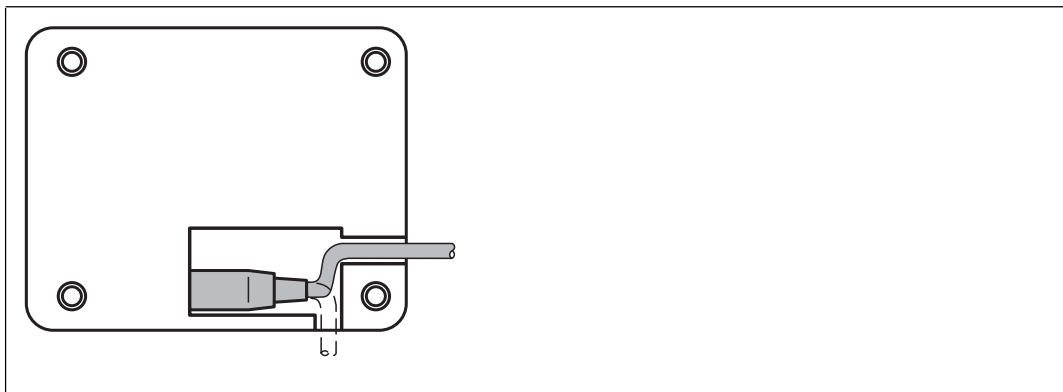

2. Place the charger in the position you wish to mount it.
3. Screw the charger into place using the mounting holes provided.



Charging the Handheld Reader

1. Ensure that the charger is connected to the USB cable or the plug of the plug-in power supply.
2. Place the handheld reader in the charger.
3. When the handheld reader's battery is charging, the battery's charge status display flashes.

Charge Status Display

To check the charge status of the lithium-ion battery, press the button on the back of the battery.

Charge status	LED 1	LED 2	LED 3	LED 4
75 % ... 100 %	ON	ON	ON	ON
50 % ... 75 %	ON	ON	ON	
25 % ... 50 %	ON	ON		
10 % ... 25 %	ON			
0 % ... 10 %	Flashing			

3.3

Installing Vision Configurator

Vision Configurator is a piece of configuration software for camera-based sensors. The software allows you to perform advanced configuration of the sensor using a clearly arranged user interface. Standard tasks include parameterization of the handheld reader, saving data sets, as well as the transfer and display of data and error diagnostics.



Note!

As an alternative to configuration using Vision Configurator, you can configure the handheld reader using control codes.



Installing Vision Configurator

1. Download the current version of Vision Configurator from <http://www.pepperl-fuchs.com>.
2. Open the installation file.
3. Select a language.
4. Follow the instructions on the setup wizard.
5. Before exiting the setup wizard, select **Install OHV USB driver**. A virtual COM port is installed that Vision Configurator uses to communicate with OHV handheld readers.



Completing the Vision Configurator Setup Wizard

Setup has finished installing Vision Configurator.

NOTE: To use one of the devices listed below, please first connect your device with your PC and install the corresponding driver.

- Install PCV Profibus, Profinet, Ethernet/IP, CANopen driver
- Install PCV/PGV RS485, SSI-USB driver
- Install OHV USB driver
- Launch Vision Configurator

PEPPERL+FUCHS
SENSING YOUR NEEDS

3.4 Installing Device Drivers

The handheld reader registers itself as an input device or keyboard. Special device drivers are not needed.

- **USB connection:** The operating system automatically installs the drivers for input devices (Human Interface Device). An active internet connection is required, depending on the operating system.
- **Bluetooth connection:** The handheld reader identifies itself as an external input device during coupling.

4 Configuration

4.1 Switching On the Handheld Reader

To switch on the handheld reader, hold down any trigger button for approx. two seconds. The function indicator on the handheld reader briefly lights up red then briefly lights up green. An audible signal is emitted and the handheld reader vibrates.

4.2 Selecting the Operating Mode

The handheld reader has four different operating modes.

Mode	Description
Docking Mode	The charger is connected to a PC and the Bluetooth connection is deactivated. Read codes are saved on the handheld reader. As soon as the handheld reader is plugged into the charger, the codes are transferred to the PC and the handheld reader's memory is cleared.
Bluetooth Mode	The charger is connected to a PC and the Bluetooth connection is activated. Read codes are transferred to the charger via Bluetooth immediately after they are read. The charging tray then automatically transfers the codes to the PC.
Tablet Mode	The handheld reader is connected to a tablet PC or a smartphone (Android version 4.1 or higher, iOS version 5.1 or higher) via Bluetooth. Read codes are transferred to a tablet PC or smartphone via Bluetooth immediately after they are read.
Configuration Mode	The charger is connected to a PC and the Bluetooth connection is deactivated. Configuration mode is exclusively used for communication with Vision Configurator. See chapter 4.4 Read codes are saved on the handheld reader. As soon as the handheld reader is inserted into the charger, the codes are transferred to Vision Configurator. Once configuration has been completed, switch back to the original operating mode.

4.2.1 Docking Mode



Activating Docking Mode

1. Deactivate the charger's Bluetooth function. Move the slider on the back/underside of the charger in the opposite direction to the arrow.
2. Read the following code using the handheld reader.



CC002940_3

↳ Docking mode is activated. Read codes are saved on the handheld reader. As soon as the handheld reader is plugged into the charger, the codes are transferred to the PC and the handheld reader's memory is cleared.



Note!

In docking mode, data is transferred as ASCII characters by default.

If data is not transferred correctly in docking mode, modify the keyboard layout. See chapter 4.2.5



4.2.2 Bluetooth Mode



Activating Bluetooth Mode

1. Activate the charger's Bluetooth function. Move the slider on the back/bottom of the charger in the direction of the arrow.
2. If you switch to Bluetooth mode from some other operating mode, read the following code using the handheld reader.
If the handheld reader was already in Bluetooth mode, you can skip this step.



CC002942_Reader_step1_2

3. Read the **Quick Connect** code on the front of the charger or the modem.
↳ Bluetooth mode is activated. Read codes are transferred to the charger via Bluetooth immediately after they are read. The charging tray then automatically transfers the codes to the PC.



Note!

In Bluetooth mode, data is transferred using a US English keyboard layout by default. If data is not transferred correctly in Bluetooth mode, modify the keyboard layout. See chapter 4.2.5

4.2.3 Tablet Mode



Activating Tablet Mode

1. Activate the Bluetooth function on the tablet PC or smartphone.
2. Read the following code using the handheld reader.



OHV2000

3. On the tablet PC or smartphone, search for Bluetooth devices within the detection range.
4. Select **OHV2000** from the list of available devices.
Devices are visible in the list for a limited period of time only. If the handheld reader is no longer displayed, read the code again.
↳ A confirmation code appears on the tablet PC or smartphone.
5. Input the digits for the confirmation code by using the handheld reader to read in the codes for each digit. Confirm the input by reading in the code for **Enter**.



↳ The handheld reader is paired with the tablet PC or smartphone. Read codes are transferred to a tablet PC or smartphone via Bluetooth immediately after they are read.



Note!

In tablet mode, data is transferred using a US English keyboard layout by default.

If data is not transferred correctly in tablet mode, modify the keyboard layout. See chapter 4.2.5

4.2.4

Configuration Mode



Activating Configuration Mode

1. Deactivate the charger's Bluetooth function. Move the slider on the back/underside of the charger in the opposite direction to the arrow.
2. Read the following code using the handheld reader.



3. Insert the handheld reader into the charger to establish a connection with the PC.

↳ Configuration mode is activated. This mode is exclusively used for communication with Vision Configurator.



Note!

In configuration mode, data is transferred as ASCII characters by default.

To select a different keyboard layout, see the **Device Settings** area in Vision Configurator.



4.2.5 Keyboard Layout

You can use the following control codes to modify the keyboard layout for the current operating mode.

Microsoft Windows

English (US)

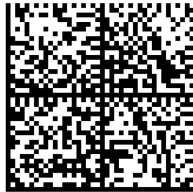

M10460_02

English (US International)

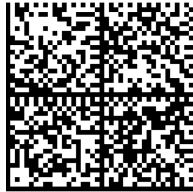

M10469_01

English (GB)



M10471_01

German (Germany)



M10463_02

German (Switzerland)



M10466_02

French (France)



M10462_02

French (Belgium)

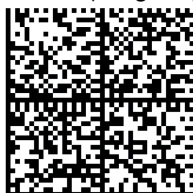

M10461_02

Spanish (Spain)

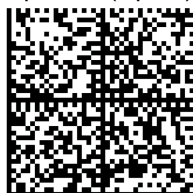

M10472_01

Spanish (Latin America)



M10465_02

Russian

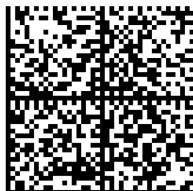

M10418_02

Japanese

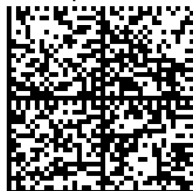

M10464_02

Apple OS X and iOS



4.3 Configuring the Handheld Reader

There are two different ways to configure the handheld reader.

- **Vision Configurator:** The software allows you to perform advanced configuration on a PC using a clearly arranged user interface. Standard tasks include parameterization of the handheld reader, saving data sets, as well as the transfer and display of data and error diagnostics. See chapter 4.4
- **Control codes:** Control codes allow direct configuration without using a PC. To adjust a parameter, scan the appropriate control code using the handheld reader. See chapter 4.5

4.4 Configuration Process Using Vision Configurator

To configure the handheld reader using Vision Configurator, you must activate configuration mode. This mode is exclusively used for communication with Vision Configurator. If you are configuring the handheld reader using control codes, you do not need to switch to configuration mode.



Note!

Once configuration has been completed, switch back to an operating mode. See chapter 4.2



Starting Vision Configurator

Before working with Vision Configurator, ensure that the handheld reader is in configuration mode. See chapter 4.2.4

1. Start Vision Configurator.
2. Select the user name **Default** in the **User** area. There are no different user rights for OHV handheld readers.
3. Select **Handheld readers** in the **Sensor family** area.
4. Select the relevant model, the type of connection **USB**, and **USB to Virtual COM Port**.
5. Select a language in the **Language** area.
6. Click on **OK**.

4.4.1 Layout of Application Window

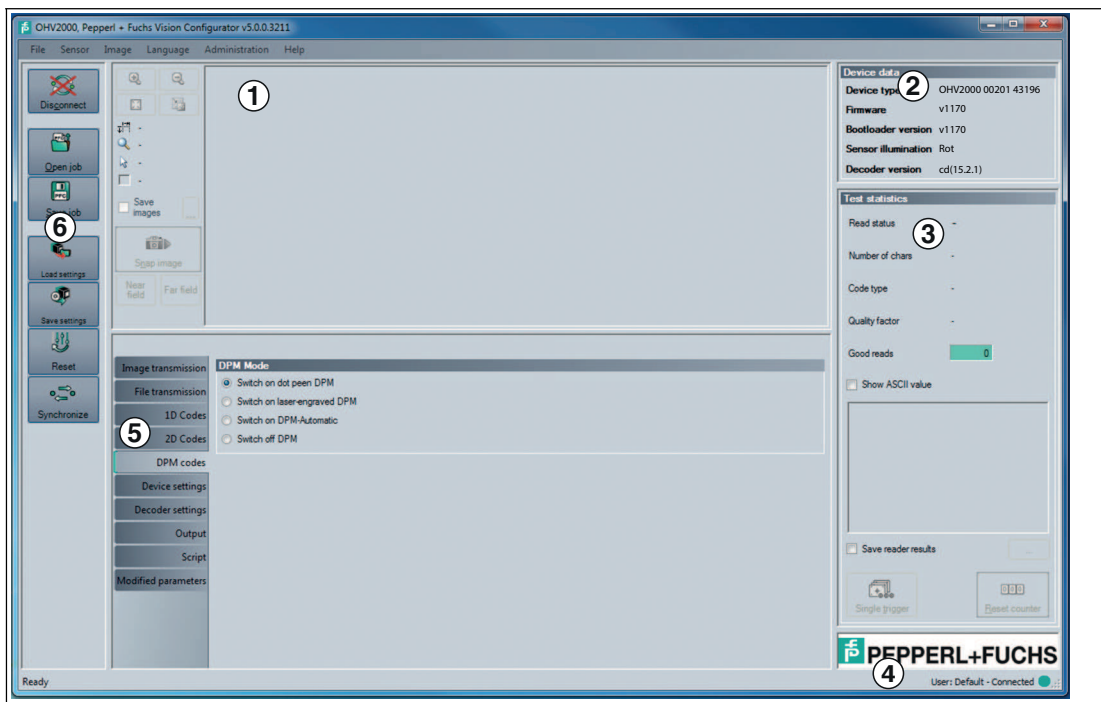
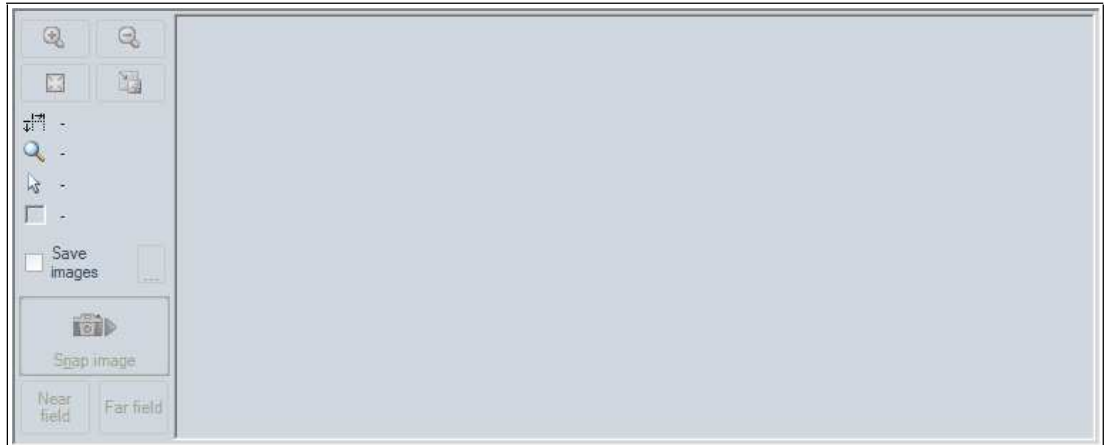

Figure 4.1 Application screen

- 1 The display area shows the read images and offers basic editing tools.
- 2 The **Sensor data** area shows information about the connected sensor.
- 3 The **Test statistics** area shows information on the read codes.
- 4 The status bar shows information about the user who is logged in as well as the sensor connection status.
- 5 The parameter area is split into several subareas und contains sensor-specific parameters.
- 6 The toolbar allows direct acess to selected menu items.

4.4.2 Image Display

Image display is not supported on OHV handheld readers in the OHV2000 series. However, any images captured using the handheld reader in the near field and far field can be analyzed and edited on your PC using a program of your choice.



Retrieving Images

1. Call up the **Image transmission** configuration window.
2. Select **Save all images** in the **Image saving mode on sensor** area.
3. Read a code.
4. Call up the **File transmission** configuration window.
5. Select the corresponding image file in the **On sensor saved files** area and click **Download selected file(s) from sensor**.
↳ The image is downloaded to your PC, where you can analyze or edit it using a program of your choice.
6. Once you have finished analyzing the images, select **Save no image** in the **Image saving mode on sensor** area to increase the reading speed of the handheld reader and use less memory.

4.4.3 Device Data

This area shows information about the connected sensor. The following figure contains example data.

Device data	
Device type	OHV2000 00201 43196
Firmware	v1170
Bootloader version	v1170
Sensor illumination	Rot
Decoder version	cd(15.2.1)



4.4.4 Test Statistics

This area shows information about the read code.

Show ASCII value	Activate this option to display the read result in ASCII characters.
Save reader results	Activate this option to save read results locally. If you have activated this option, you can select a location to save the results.
Single trigger	Triggers a read operation.
Reset counter	Clears the contents of the Test statistics area.

4.4.5 Image Transmission

This is where you can define the settings for saving read codes.



Note!

Saving images when decoding increases the decoding time.



Image Saving Mode on Sensor

Save mode when sensor triggers	<input type="checkbox"/> Save no image <input type="checkbox"/> Save all images <input type="checkbox"/> Save non decoded images <input type="checkbox"/> Save decoded images
---------------------------------------	--

Frame Quality on Sensor

Save frames uncompressed on sensor	The recorded image is saved uncompressed in portable graymap format on the sensor.
Save frames compressed on sensor	The recorded image is saved compressed in JPEG format on the sensor.
Image quality	If the image is to be saved in JPEG format, you can define the image quality here. <ul style="list-style-type: none"> <input type="checkbox"/> 0 %: maximum compression, lowest image quality <input type="checkbox"/> ... <input type="checkbox"/> 100 %: minimum compression, highest image quality

4.4.6 File Transmission

This is where you can manage files saved on the sensor.

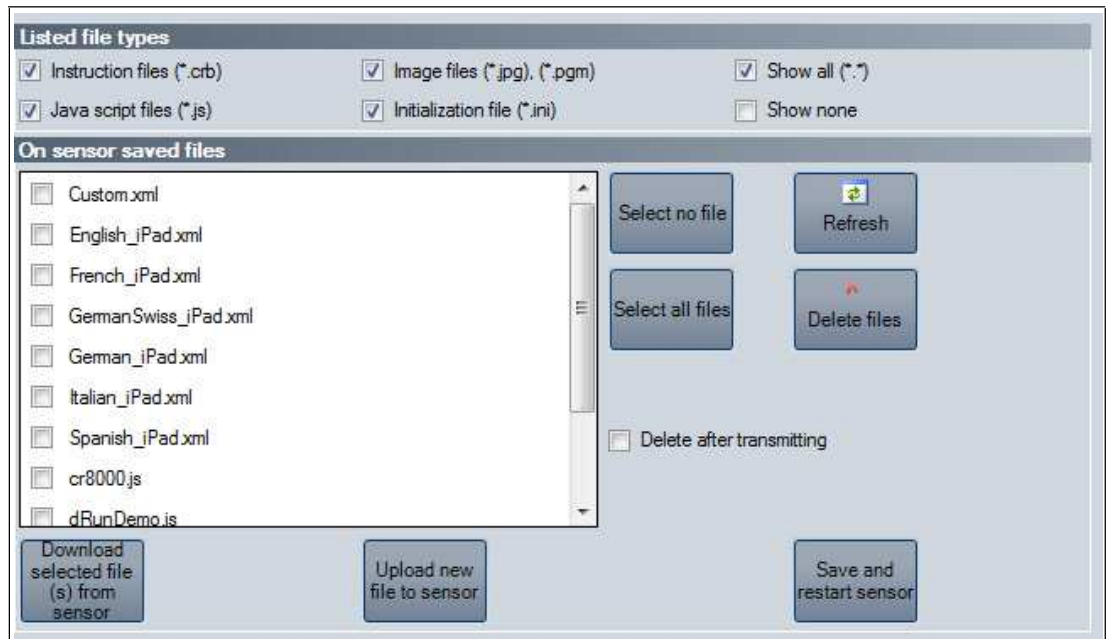

2016-05

Listed File Types

Instruction files	Displays the command files on the sensor with file extension crb
Java script files	Displays the JavaScript files on the sensor with file extension js
Image files	Displays the graphics files on the sensor with file extension jpg or pgm
Initialization file	Displays the initialization files on the sensor with file extension ini
Show all	Displays all the files on the sensor
Show none	Displays no files on the sensor

On sensor saved files

Select no file	Cancels selection on all files
Refresh	Updates the display of files
Select all files	Selects all the files on the sensor
Delete files	Deletes the selected files
Delete after transmitting	The selected files on the sensor are deleted following transfer from the sensor to the PC
Download selected file(s) from sensor	Loads the selected files from the sensor to the PC
Upload new file to sensor	Loads the file to the sensor
Save and restart sensor	Saves the current sensor settings and restarts the sensor



Updating Firmware

1. Click on **Upload new file to sensor** or select **Sensor > Update Firmware** in the menu bar.
2. Select a firmware file with the extension **crz**.
3. The firmware file is transferred to the handheld reader. Uploading the firmware takes a few minutes.
4. Once the file has been transferred, the handheld reader automatically restarts.
 - ↳ The firmware is now updated. You can check the firmware version in the **Device data** area.

4.4.7

1-D Codes

This is where you can define which 1-D code types the handheld reader should read. Different code types are shown depending on the sensor used and the firmware version.



Tip

Deactivate all code types that are not required and activate only the code types that you wish to read. This increases the evaluation speed and prevents a code type such as Codablock being mistakenly interpreted as another code type, such as Code 128.



Activating 1-D Codes

1. To activate a code type, check the check box in front of the code type designation.
↳ Advanced options for the selected code type are shown in the area on the right.
2. Activate or deactivate the advanced options.
3. To save the settings, select **Sensor > Save settings** in the menu bar.



Deactivating 1-D Codes

1. To deactivate a code type, uncheck the check box in front of the code type designation.
2. To save the settings, select **Sensor > Save settings** in the menu bar.

4.4.8

2-D Codes

This is where you can define which 2-D code types the handheld reader should read. Different code types are shown depending on the sensor used and the firmware version.



Tip

Deactivate all code types that are not required and activate only the code types that you wish to read. This increases the evaluation speed and prevents a code type such as Codablock being mistakenly interpreted as another code type, such as Code 128.

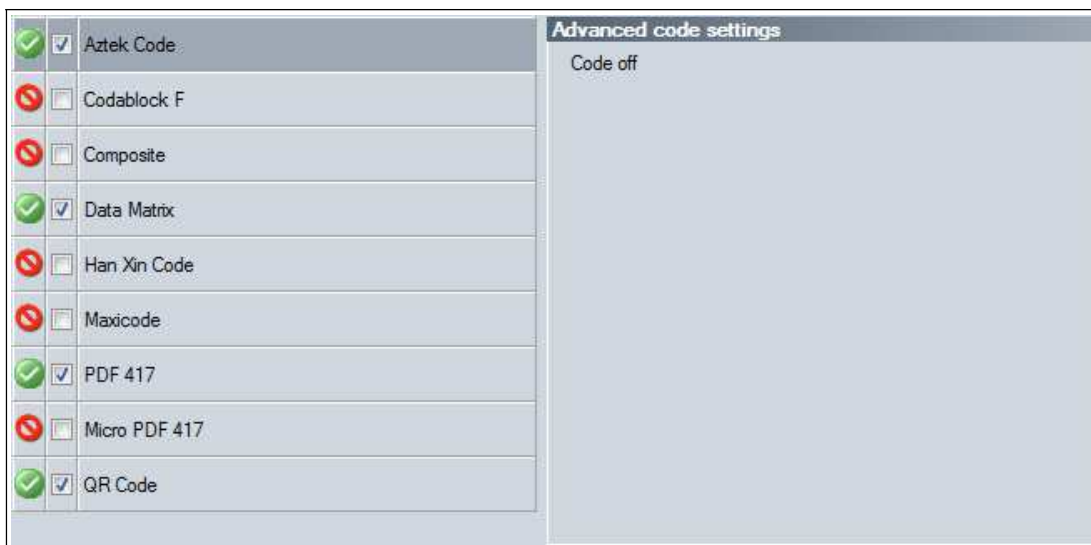

Activating 2-D Codes

1. To activate a code type, check the check box in front of the code type designation.
↳ Advanced options for the selected code type are shown in the area on the right.
2. Activate or deactivate the advanced options.
3. To save the settings, select **Sensor > Save settings** in the menu bar.

Deactivating 2-D Codes

1. To deactivate a code type, uncheck the check box in front of the code type designation.
2. To save the settings, select **Sensor > Save settings** in the menu bar.

4.4.9

DPM Codes

On this screen, you can set the DPM mode (direct part marking), i.e., detection of 1-D or 2-D codes applied directly to an object as laser-engraved or dot peen codes.

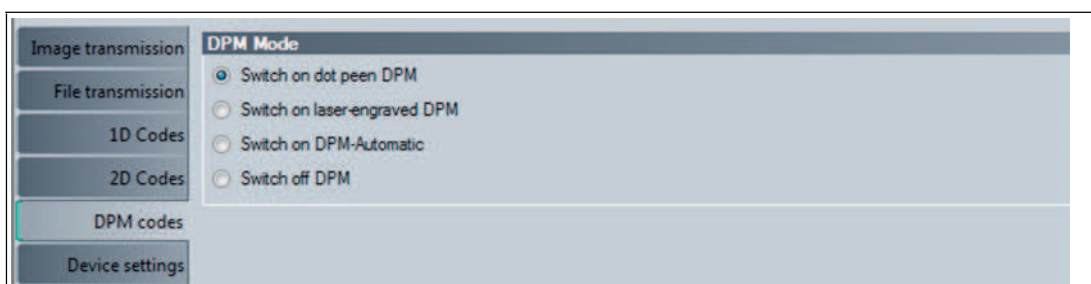

DPM Mode

Switch on dot peen DPM	This option allows you to switch on detection of dot peen 1-D or 2-D codes.
Switch on laser-engraved DPM	This option allows you to switch on detection of laser-engraved 1-D or 2-D codes.
Switch on DPM-Automatic	This option allows you to switch on automatic detection of whether the code to be read is laser-engraved or dot peen.
Switch off DPM	This option allows you to switch off detection of DPM codes.

4.4.10 Sensor Settings

This is where you can configure the feedback. Since the sensor registers itself with other devices as an input device or keyboard, you can configure which keyboard layout the sensor should use for data transfer.



Note!

To ensure the correct transfer of data, it is important to select the right keyboard layout. Depending on the keyboard selected, individual characters, e.g., special symbols, are output differently.

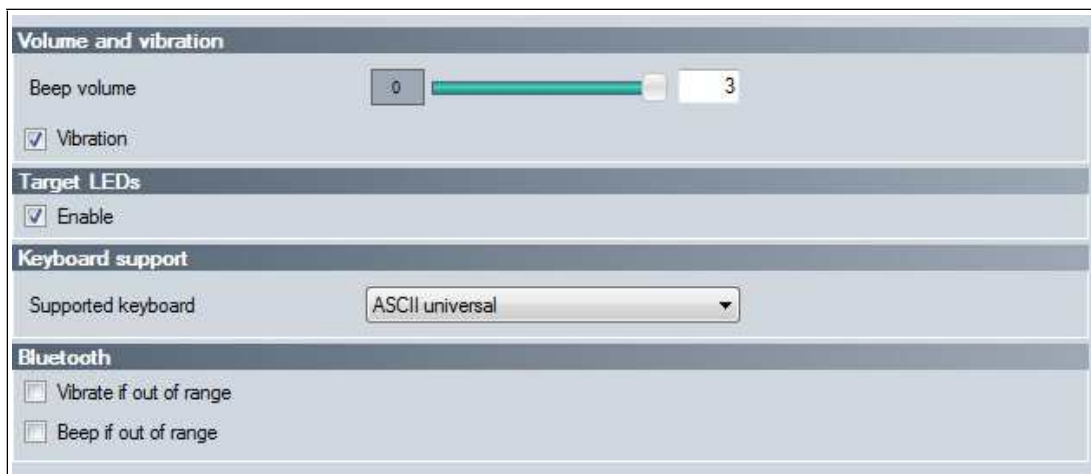

Volume and Vibration

Beep volume	You can adjust the volume of the audible signal here. <ul style="list-style-type: none"> ■ 0: silent ■ ... ■ 3: maximum volume
Vibration	You can activate or deactivate vibration here.

Target LEDs

Enable	You can activate or deactivate the blue bars that indicate the reading field here.
---------------	--



Keyboard Support

Supported keyboard	<ul style="list-style-type: none"> ■ US keyboard without leading zero ■ ASCII general ■ User-defined keyboard ■ French keyboard ■ German keyboard ■ Japanese keyboard ■ Swiss keyboard ■ Belgian keyboard ■ UK keyboard ■ Latin American keyboard ■ Spanish keyboard ■ Russian keyboard
---------------------------	---

Bluetooth

Vibrate if out of range	The handheld reader vibrates as soon as it leaves the base station's maximum detection range.
Beep if out of range	The handheld reader emits an audible signal as soon as it leaves the base station's maximum detection range.

4.4.11 Decoding Options

You can change settings for the read operation here.

The screenshot shows a configuration window with the following sections:

- Display:** Contains a checkbox for "Enhanced display reading" which is currently unchecked.
- Continuous reading:** Contains a checkbox for "Continuous reading" which is currently unchecked.
- Duplicate codes:** Contains a label "Duplicate code scan delay" and a dropdown menu currently set to "None".
- Reading field:** Contains three radio button options: "Near and far field" (which is selected), "Near field", and "Far field".

Display

Optimized reading of displays	Optimizes the optical unit on the handheld reader to read reflective surfaces such as displays.
--------------------------------------	---

Continuous Reading

Continuous Reading	You can activate or deactivate continuous reading here. If this option is activated, the sensor continuously attempts to read a code, without the user having to activate a trigger button.
---------------------------	---

Code Duplicates

<p>Scan delay on the same code</p>	<p>This option prevents the same code from being read twice in direct succession within a selected time frame. After the time frame has elapsed or if another code has been read in the interim, the same code can be read again. This option is particularly useful in conjunction with continuous reading, since it can prevent the same code from being read multiple times.</p> <ul style="list-style-type: none"> <input type="checkbox"/> None <input type="checkbox"/> ... <input type="checkbox"/> 1 day
---	---

Reading Field

<p>Selection</p>	<p>With this option, you can select whether the near field, far field, or both together are used for reading. If you deactivate a field, the evaluation speed increases, but codes in the deactivated field can no longer be read.</p>
-------------------------	--

4.4.12 Read Result

You can process the read result and assign a prefix or suffix to the result here. The prefix is placed in front of the read result and the suffix is placed at the end of the read result.

If the read result is additionally processed by a script, the prefixes or suffixes are assigned immediately following script processing.

Prefix/Suffix

<p>Prefix</p>	<p>You can input a value for the prefix here. To delete the prefix, click on Delete prefix.</p>
<p>Suffix</p>	<p>You can input a value for the suffix here. To delete a suffix, click on Delete suffix.</p>

Inserting Special Symbols for Keyboard Mode

<p>Prefix TAB</p>	<p>Click on Prefix TAB to insert a tab character into the prefix field.</p>
<p>Suffix TAB</p>	<p>Click on Suffix TAB to insert a tab character into the suffix field.</p>
<p>Suffix ENTER</p>	<p>Click on Suffix ENTER to insert an input character into the suffix field.</p>
<p>more ...</p>	<p>Click on more ... to call up a list of additional special characters. To insert a special character from the list, click on the + icon in the corresponding line. Different special characters are available depending on whether the handheld reader is connected to Vision Configurator via USB or via RS-232.</p>



Additional Outputs

Output the code type of the read code	If you activate this option, the code type of the read code will be output between the prefix and the read result. If the sensor is connected to Vision Configurator, the code type is displayed in the Test statistics area.
--	--

4.4.13 Script

Here you can process the read result using JavaScript. You can input your own source code or assemble a script from predefined blocks.

If a prefix or a suffix is additionally assigned to the read result, the prefixes or suffixes are assigned immediately following the script processing.

Key layout

Upper button	Read in both fields		Insert special characters
Lower button	Read in both fields		
Both buttons simultaneously	No action		...

Input codes

Insert	Command	Description	Codomain
+	SUBSTRING_FROM_POSITION_x_O...	<i>Output y chars from position x, zero based</i>	x: int, y: int
+	SUBSTRING_FROM_POSITION_x_O...	<i>Output all chars from position x, zero based</i>	x: int
+	OUTPUT_LAST_x_CHARS	<i>Output last x chars</i>	x: int

Source code

	Codesymbology	Prefix read code	Prefix current code	Command
*	none			

Insert special characters
...

Example

Read code	123456789	Output	123456789
-----------	-----------	--------	-----------

Script transmission

Send script to device

Remove script from device

Save and restart device

Reset with code

Create reader programming code

Create control code from file

Button Assignment

In this area, you can assign defined functions to the trigger buttons on the top of the handheld reader. You can also use the **Insert special characters** button to assign function keys **F1 ... F12** or key combinations to the trigger buttons.



Figure 4.2 Trigger buttons

1. Upper button
2. Lower button

Input Codes

The following predefined components are available:

`SUBSTRING_FROM_POSITION_x_ON_y_CHARS`

Only returns one part of the code. *x* denotes the position from which the characters are output, where *x* = 0 represents the first character of the code. *y* denotes the number of characters that are output after position *x*.

Example: `SUBSTRING_FROM_POSITION_6_ON_3_CHARS` returns characters 7 to 9.

`SUBSTRING_FROM_POSITION_x_ON_ALL_CHARS`

Only returns one part of the code. *x* refers to the position from which all subsequent characters are returned, where *x* = 0 represents the first character of the code.

`OUTPUT_LAST_x_CHARS`

Returns the last *x* characters of the code.

Example: `OUTPUT_LAST_3_CHARS` returns the last 3 characters.

`OUTPUT_ALL_CHARS_BETWEEN_abc_AND_def`

Returns the characters of the code that are between an *abc* and *def* data string. If there are multiple occurrences of the data strings *abc* and *def*, only the characters between the first occurrence are returned. If the data string *abc* does not appear, no characters are returned.

`OUTPUT_ALL_CHARS_BEFORE_abc`

Returns the characters of the code that appear before an *abc* data string. If there are multiple occurrences of the data string *abc*, all characters before the first occurrence are returned. If the data string *abc* does not appear, no characters are returned.

`OUTPUT_ALL_CHARS_AFTER_abc`

Returns the relevant characters of the code that follow the data string *abc*. If the data string *abc* appears several times, all characters from the first occurrence are returned and subsequent occurrences of the data string *abc* are deleted. If the data string *abc* does not appear, no characters are returned.

`OUTPUT_x_CHARS_AFTER_abc`

Returns *x* relevant characters of the code that follow the data string *abc*. If the data string *abc* appears several times, *x* characters from the first occurrence are returned and subsequent occurrences of the data string *abc* are deleted. If the data string *abc* does not appear, no characters are returned.

`DELETE_FROM_POSITION_x_ON_y_CHARS`

Deletes part of the code. *x* refers to the position from which the *y* characters are removed, where *x* = 0 represents the first character of the code.

Example: `DELETE_FROM_POSITION_0_ON_5_CHARS` deletes characters 1 to 5.

`DELETE_SUBSTRING_abc`

Deletes the data string `abc` from the code. If the data string occurs several times, only the first occurrence of the data string is deleted.

`DELETE_LAST_x_CHARS`

Deletes the last `x` characters of the code.

Example: `DELETE_LAST_4_CHARS` deletes the last 4 characters.

`DELETE_ALL_CHARS_BEFORE_abc`

Deletes all characters of the code that appear before an `abc` data string. If there are multiple occurrences of the data string `abc`, only the characters that appear before the first occurrence are deleted.

`DELETE_ALL_CHARS_AFTER_abc`

Deletes all characters of the code that follow the data string `abc`. If there are multiple occurrences of the data string, all characters after the first occurrence are deleted.

`INSERT_abc_AT_POSITION_x`

Adds the data string `abc` at position `x`, where `x = 0` represents the position before the first character of the code.

`INSERT_abc_AFTER_def`

Adds the data string `abc` to the data string `def`. If the data string `def` appears several times, the data string `abc` is appended to the first occurrence. If the data string `def` does not appear, no characters are appended.

`APPEND_STRING_abc`

Appends the data string `abc` to the code.

`IF_GOODREAD_OUTPUT_abc`

Returns the data string `abc` if a code has been read successfully.

`REPLACE_STRING_abc_WITH_def`

Replaces the data string `abc` with the data string `def`. If the data string `abc` occurs multiple times, only the first occurrence is replaced.

`REPLACE_ALL_abc_AFTER_POSITION_x_WITH_def`

Replaces the data string `abc` with data string `def` after position `x`. If the data string `abc` appears after position `x` several times, all occurrences are replaced.

`IF_CODE_CONTAINS_abc_OUTPUT_def`

Returns the data string `def` if the data string `abc` appears in the code. If the data string `abc` appears several times, the data string `def` is returned only once.

`APPEND_FROM_ORIGINAL_ALL_CHARS_AFTER_abc`

Appends all of the characters that follow the data string `abc` in the read code to the output. This rule applies directly to the read code and is independent of other rules already applied to the code. If the data string `abc` appears several times, all characters from the first occurrence are appended and subsequent occurrences of the data string `abc` are deleted. If the data string `abc` does not appear, no characters are appended.

`APPEND_FROM_ORIGINAL_x_CHARS_AFTER_abc`

Appends `x` characters that follow the data string `abc` in the read code to the output. This rule applies directly to the read code and is independent of other rules already applied to the code. If the data string `abc` appears several times, `x` characters from the first occurrence are appended and subsequent occurrences of the data string `abc` are deleted. If the data string `abc` does not appear, no characters are appended.

Source Code

You can edit the source code for the script in the source code area. You can also use the **Insert special characters** button to insert certain special characters.

Example

In this area, you can test the result by using an example.

Script Transfer

Button	Description
Open	Opens a locally stored script file.
Save	Saves the current script to a local file.
Send script to sensor	Saves the script on the sensor.
Delete script from sensor	Deletes the script from the sensor.
Save and restart	Saves the script on the sensor. The sensor then restarts and the script is activated.
Reset with code	Creates a control code that can be used to reset the sensor. After reading the control code, the sensor restarts.
Create control code	Generates a control code for the script. After reading the control code, the sensor restarts and the script is activated if the script has already been saved on the sensor.
Create control code from file	Generates a control code for the script from a file. After reading the control code, the sensor restarts and the script is activated if the script has already been saved on the sensor.



Creating a Script

1. In the **Source code** area, click on a cell in the first column to edit the associated line.
2. Click on **+** to insert a predefined module in the selected line. You can also insert multiple commands and combine these with one another.

Key layout

Upper button: Read in both fields
 Lower button: Read in both fields
 Both buttons simultaneously: No action

Input codes

Insert	Command	Description	Codomain
+	SUBSTRING_FROM_POSITION_x_ON_y_CHA...	Output y chars from position x, zero based	x: int, y: int
+	SUBSTRING_FROM_POSITION_x_ON_ALL_C...	Output all chars from position x, zero based	x: int
+	OUTPUT_LAST_x_CHARS	Output last x chars	x: int

Source code

	Codesymbology	Prefix read code	Prefix current code	Command
	none			SUBSTRING_FROM_POSITION_x_ON_y...
*	none			

Example

Read code: 123abc456xyz789 Output: 123abc456xyz789

Script transmission

Buttons: Send script to device, Remove script from device, Save and restart device, Reset with code, Create reader programming code, Create control code from file

↳ The command appears in the selected line. If the source code is shaded red, the source code is incomplete or contains errors. If the source code is green, the source code is OK.

- Complete the variables so that the command can be executed.
 If a command is to be executed only for a specific code type, select the relevant code type in the **Code symbology** column.
 If a command is to be executed only when the read code begins with a certain data string, input the data string in the **Prefix of read code** column.
 If a command is to be executed only when the current processing result begins with a certain data string, input the data string in **Prefix of current code** column.
 To insert special characters, click on **Insert special characters**.
- If the source code is green, you can test the source code in the **Example** area. To do this, enter a sample value in the **Read code** field.

The screenshot shows a configuration window with several sections:

- Key layout:** Three rows for 'Upper button', 'Lower button', and 'Both buttons simultaneously'. Each row has a dropdown menu (e.g., 'Read in both fields') and an 'Insert special characters' button.
- Input codes:** A table with columns 'Insert', 'Command', 'Description', and 'Codomain'. It lists three commands: 'SUBSTRING_FROM_POSITION_x_ON_y_CHA...', 'SUBSTRING_FROM_POSITION_x_ON_ALL_C...', and 'OUTPUT_LAST_x_CHARS'.
- Source code:** A table with columns 'Codesymbology', 'Prefix read code', 'Prefix current code', and 'Command'. A red arrow points from the 'SUBSTRING_FROM_POSITION_3_ON_4_...' command in this table to the 'Example' section.
- Example:** A section with a 'Read code' field containing '123abc456xyz789' and an 'Output' field containing 'abc4'. This section is highlighted with a red box.
- Script transmission:** A row of buttons including 'Send script to device', 'Remove script from device', 'Save and restart device', 'Reset with code', 'Create reader programming code', and 'Create control code from file'.

↳ The commands from the **Source text** area are applied to the sample value in the **Read code** field and the result is displayed in the **Output** field.

4.4.14 Edited Parameters

Here you can find an overview of all settings you have changed that now deviate from the factory settings.

To generate a control code that contains all affected settings, click on **Create control code for own settings**.

If you check the **First completely reset sensor** check box, a reset command is integrated in the control code. When the control code is read, all settings are first reset to factory defaults before the new settings are applied.



Note!

Scripts for processing the read result are not included in this overview.



Tip

This function allows your configured settings to be transferred to multiple sensors by scanning the control code.

Parameters not on default value			
Parametername	Tab	Default value	Current value
Supported keyboard	Sensor settings	US keyboard without leading zero	ASCII universal

Custom settings

Reset sensor first

Create control code for custom settings



4.5 Configuration with Control Codes

As an alternative to configuration using Vision Configurator, you can configure the handheld reader using control codes. Control codes allow direct configuration without using a PC. To adjust a parameter, scan the appropriate control code using the handheld reader.



4.5.1 Operation

The following codes can be used to adjust the settings for operation.











Paging Function



Code	Description
Enable Reader Paging  M10155_01	Activates the paging function. The paging function works only in Bluetooth mode. If you hold down the Bluetooth button on the charger for around two seconds, the handheld reader emits visual and audible signals and vibrates, depending on its settings. To switch the signals off, hold down the Bluetooth button on the charger for around two seconds or press the trigger on the handheld reader.
Disable Reader Paging  M10156_01	Deactivates the paging function.

Target Detection

Code	Description
Targeting On  M10153_01	Activates the blue bars for indicating the read range.
Targeting Off  M10154_01	Deactivates the blue bars for indicating the read range.

Feedback



Code	Description
Beep On / Vibrate On  M10140_01	Switches audible signals and vibration on.
Beep Off / Vibrate On  M10141_01	Switches audible signals off and vibration on.
Beep On / Vibrate Off  M10142_01	Switches audible signals on and vibration off.
Beep Off / Vibrate Off  M10143_01	Switches audible signals and vibration off.
Beep volume 0 %  M10194_01	Sets the volume of the audible signal to 0 %.
Beep volume 33 %  M10195_01	Sets the volume of the audible signal to 33 %.
Beep volume 67 %  M10196_01	Sets the volume of the audible signal to 67 %.
Beep volume 100 %  M10197_01	Sets the volume of the audible signal to 100 %.
Bluetooth Radio Out of Range Beep On  M10173_01	Activates an audible alarm if the handheld reader loses the Bluetooth connection.
Bluetooth Radio Out of Range Vibrate On  M10174_01	Activates a vibration alarm if the handheld reader loses the Bluetooth connection.

Code	Description
Bluetooth Radio Out of Range Beep and Vibrate On  M10175_01	Activates an audible alarm and a vibration alarm if the handheld reader loses the Bluetooth connection.
Bluetooth Radio Out of Range Beep and Vibrate Off  M10176_01	Deactivates the audible alarm and the vibration alarm if the handheld reader loses the Bluetooth connection.



4.5.2 Read Operation



The following codes can be used to adjust the settings for the read operation.

Reading Displays



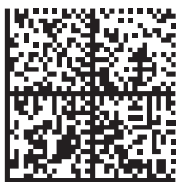

Code	Description
Enable Cell Phone Reading Enhancement  M10163_01	Optimizes the optical unit on the handheld reader to read reflective surfaces such as displays.
Disable Cell Phone Reading Enhancement  M10162_01	Deactivates optimization for reading reflective surfaces.







Motion detection

Code	Description
Motion Detection On Start Delay 0 ms  M0161_03	Activates motion detection with a start delay of 0 ms. If motion detection is activated, the handheld reader automatically attempts to read a code as soon as motion is detected in the read range. It is not necessary to activate the trigger button.
Motion Detection On Start Delay 500 ms  M0162_03	Activates motion detection with a start delay of 500 ms. If motion detection is activated, the handheld reader automatically attempts to read a code as soon as motion is detected in the read range. It is not necessary to activate the trigger button.

Code	Description
Motion Detection On Start Delay 0 ms Dark Environment  M0163_03	Activates motion detection with dimmer readiness lighting and a start delay of 0 ms. If motion detection is activated, the handheld reader automatically attempts to read a code as soon as motion is detected in the read range. It is not necessary to activate the trigger button.
Motion Detection On Start Delay 500 ms Dark Environment  M0164_03	Activates motion detection with dimmer readiness lighting and a start delay of 500 ms. If motion detection is activated, the handheld reader automatically attempts to read a code as soon as motion is detected in the read range. It is not necessary to activate the trigger button.
Motion Detection Off  M0129_08	Deactivates motion detection.

Continuous Reading







Code	Description
Continuous Scan On  M10012_01	Activates continuous reading. If this option is activated, the sensor continuously attempts to read a code, without the user having to activate a trigger button.
Continuous Scan Off  M10011_01	Deactivates continuous reading.
Duplicate Scan Disabled  M10144_01	Prevents the same code from being read twice in direct succession.
1 sec Duplicate Scan Delay  M10145_01	Prevents the same code from being read twice in direct succession for a period of one second. After the time frame has elapsed or if another code has been read in the interim, the same code can be read again.

Code	Description
2 sec Duplicate Scan Delay  M10146_01	Prevents the same code from being read twice in direct succession for a period of two seconds. After the time frame has elapsed or if another code has been read in the interim, the same code can be read again.
3 sec Duplicate Scan Delay  M10147_01	Prevents the same code from being read twice in direct succession for a period of three seconds. After the time frame has elapsed or if another code has been read in the interim, the same code can be read again.
5 sec Duplicate Scan Delay  M10148_01	Prevents the same code from being read twice in direct succession for a period of five seconds. After the time frame has elapsed or if another code has been read in the interim, the same code can be read again.
10 sec Duplicate Scan Delay  M10149_01	Prevents the same code from being read twice in direct succession for a period of ten seconds. After the time frame has elapsed or if another code has been read in the interim, the same code can be read again.
30 sec Duplicate Scan Delay  M10150_01	Prevents the same code from being read twice in direct succession for a period of 30 seconds. After the time frame has elapsed or if another code has been read in the interim, the same code can be read again.
1 hour Duplicate Scan Delay  M10151_01	Prevents the same code from being read twice in direct succession for a period of 1 hour. After the time frame has elapsed or if another code has been read in the interim, the same code can be read again.
1 day Duplicate Scan Delay  M10152_01	Prevents the same code from being read twice in direct succession for a period of one day. After the time frame has elapsed or if another code has been read in the interim, the same code can be read again.



4.5.3 Data Processing



The following codes can be used to add prefixes and suffixes to read results.

Prefixes

Code	Description
Prefix AIM IDs on  M10199_01	Activates code type output immediately before the read result. If an additional prefix is applied, the code type will be written between the prefix and the read result.
Prefix AIM IDs off  M10198_01	Deactivates code type output.
Prefix comma  M10127_01	Places a comma in front of the read result.
Prefix space  M10128_01	Places a space in front of the read result.
Prefix tab  M10129_01	Places a tab character in front of the read result.
Prefix erase/none  M10126_01	Removes all prefixes.

Suffixes

Code	Description
Suffix comma  M10131_01	Adds a comma to the end of the read result.
Suffix space  M10132_01	Adds a space to the end of the read result.
Suffix enter  M10134_01	Adds an input character to the end of the read result.

Code	Description
Suffix tab  M10133_01	Adds a tab to the end of the read result.
Suffix erase/none  M10130_01	Removes all suffixes.



Clearing Prefixes and Suffixes



Code	Description
Erase all prefix and suffix data  M10135_01	Clears all prefixes and suffixes.

4.5.4 Data Transfer

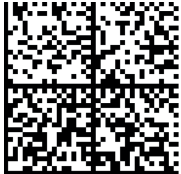
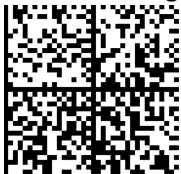

The following codes can be used to adjust the settings for data transfer.

Saving Read Results



Code	Description
Log Only  M10188_04	Activates saving of read results in the handheld reader. The results are not automatically transferred; instead they must be read out. The results remain in the memory after reading and can be retrieved again. To remove the results, the memory must be explicitly cleared. See chapter 4.5.5
Send and Log  M10186_04	Activates saving of read results in the handheld reader. The results are automatically transferred as soon as a connection to another device is established. The results remain in the memory after transfer and can be retrieved again. To remove the results, the memory must be explicitly cleared. See chapter 4.5.5
Disable Log  M10187_04	Deactivates saving of read results in the handheld reader. This setting is not supported in dock mode or configuration mode as the read results must remain stored until the handheld reader is inserted into the charger. This setting is configured by default at the factory for Bluetooth mode and tablet mode.

Code	Description
Transfer All Data in Memory  M10297_01	Reads out the handheld reader's memory. If saving of read results has been activated (Log Only or Send and Log), the results will remain stored in the memory after read-out. If saving of read results has been deactivated (Disable log), the memory will be empty following read-out.
Clear All Stored Data and Images  M10138_02	Deletes all read results and recordings stored on the handheld reader.



Bidirectional Connection





Code	Description
Reader Text Commands On  M10137_01	Facilitates a bidirectional connection to the handheld reader, which allows commands to be sent to the handheld reader via the serial interface. For example, this allows a signal indicating that a value has been successfully recorded by an ERP system to be transferred to the handheld reader.
Reader Text Commands Off  M10136_01	Deactivates the bidirectional connection via the serial interface.

USB Connection

Code	Description
Full Speed  M10161_01	Activates the USB interface's full speed mode. Suitable from USB 1.1
High Speed  M10160_01	Activates the USB interface's high speed mode. Suitable from USB 2.0

RS-232 Connection

Code	Description
RS-232 Communication Mode  M661_01	This code switches the ODZ-MAH-B15-M3 Bluetooth modem from a USB connection to an RS-232 connection.
RS-232 9600 Baud Rate  M316_01	Sets the baud rate for the RS-232 connection to 9600

Code	Description
RS-232 19200 Baud Rate  M317_01	Sets the baud rate for the RS-232 connection to 19200
RS-232 38400 Baud Rate  M318_01	Sets the baud rate for the RS-232 connection to 38400
RS-232 57600 Baud Rate  M319_01	Sets the baud rate for the RS-232 connection to 57600
RS-232 115200 Baud Rate  M320_01	Sets the baud rate for the RS-232 connection to 115200 This setting is preset at the factory.

4.5.5 Restarting and Clearing

The following codes can be used to configure the device and the device memory.

Restarting the Device

Code	Description
Reboot reader  M10296_01	Restarts the handheld reader.

Resetting the Device to Factory Settings



Code	Description
Reset reader to RF factory defaults  M10001_03	Resets the handheld reader to factory settings and then activates Bluetooth mode. To establish the Bluetooth connection, scan the Quick Connect code on the front of the charger or modem. Read results already saved on the device will not be lost as a result of doing this. Once the Bluetooth connection is established, the codes in the handheld reader's memory will be transferred via Bluetooth.

Reading the Memory

Code	Description
Transfer All Data in Memory  M10297_01	Reads out the handheld reader's memory. If saving of read results has been activated (Log Only or Send and Log), the results will remain stored in the memory after read-out. If saving of read results has been deactivated (Disable log), the memory will be empty following read-out.

2016-05

Deleting the Memory and Scripts

Code	Description
Clear All Stored Data and Images  M10138_02	Deletes all read results and recordings stored on the handheld reader.
Clear all JavaScript Rules  M10139_01	Deletes all scripts saved on the handheld reader.

4.5.6 Setting the DPM Mode

With the following codes, you can set the DPM mode (direct part marking), i.e., detection of 1-D or 2-D codes applied directly to an object as laser-engraved or dot peen codes.

Switch on dot peen DPM

Code	Description
Switch on dot peen DPM  M10370_01	Switches on detection of dot peen markings.

Switch on laser-engraved DPM

Code	Description
Switch on laser-engraved DPM  M10371_01	Switches on detection of laser-engraved markings.

Switch on DPM-Automatic

Code	Description
Switch on DPM-Automatic  M10372_01	Switches off automatic detection of dot peen and laser-engraved markings.

Switch off DPM

Code	Description
Switch off DPM  M10369_01	Switches off detection of dot peen and laser-engraved markings.



4.5.7 Code Types

The following codes can be used to define which code types the handheld reader should read.







Different code types are supported depending on the handheld reader and firmware version. Settings marked with a * are preset at the factory.











Tip















Deactivate all code types that are not required and activate only the code types that you wish to read. This increases the evaluation speed and prevents a code type such as Codablock being mistakenly interpreted as another code type, such as Code 128.

A



Australian Post			
<p>On</p>  <p>M10288_02</p>	<p>Off *</p>  <p>M10289_02</p>		
Aztec			
<p>On *</p>  <p>M10018_01</p>	<p>Off</p>  <p>M10019_01</p>	<p>Inverted (light on a dark background)</p> <p>On</p>  <p>M10020_01</p>	<p>Inverted (light on a dark background) and normal</p> <p>On</p>  <p>M10021_01</p>

C

Codabar			
<p>On *</p>  <p>M10022_01</p>	<p>Off</p>  <p>M10023_01</p>		
Codablock F			
<p>On</p>  <p>M10027_01</p>	<p>Off *</p>  <p>M10026_01</p>		
Code 11			
<p>On</p>  <p>M10029_01</p>	<p>Off *</p>  <p>M10028_01</p>	<p>Without output of checksum</p> <p>On</p>  <p>M10031_01</p>	
Code 32 (Italian Pharmacode)			
<p>On</p>  <p>M10239_02</p>	<p>Off *</p>  <p>M10238_02</p>		

Code 39			
<p>On *</p>  <p>M10033_02</p>	<p>Off</p>  <p>M10034_02</p>	<p>Only codes with checksum On</p>  <p>M10036_01</p>	<p>Only codes with checksum Off *</p>  <p>M10035_01</p>
<p>Without output of checksum On</p>  <p>M10037_01</p>			
Code 39 Extended			
<p>Decoding with full ASCII character set On</p>  <p>M10039_01</p>	<p>Decoding with full ASCII character set Off *</p>  <p>M10038_01</p>		
Code 49			
<p>On</p>  <p>M10458_01</p>	<p>Off *</p>  <p>M10459_01</p>		
Code 93			
<p>On *</p>  <p>M10042_01</p>	<p>Off</p>  <p>M10043_01</p>		
Code 128			
<p>On *</p>  <p>M10044_01</p>	<p>Off</p>  <p>M10045_01</p>		
Composite			
<p>On</p>  <p>M10047_01</p>	<p>Off *</p>  <p>M10046_01</p>		











D

Data Matrix			
<p>Reading of standard Data Matrix codes is always enabled and cannot be disabled.</p>	<p>Inverted (light on a dark background) On *</p>  <p>M10051_03</p>	<p>Inverted (light on a dark background) Off</p>  <p>M10050_03</p>	













2016-05



E

EAN-8			
Check digit output On *  M10485_01	Check digit output Off  M10486_01	Convert EAN-8 to EAN-13 On  M10488_01	Convert EAN-8 to EAN-13 Off *  M10487_01
EAN-13			
Check digit output On *  M10483_01	Check digit output Off  M10484_01	Convert Bookland EAN-13 to ISBN On  M10492_01	Convert Bookland EAN-13 to ISBN Off *  M10491_01
Convert Bookland EAN-13 to ISSN On  M10494_01	Convert Bookland EAN-13 to ISSN Off *  M10493_01		
For other settings, see UPC (Universal Product Code) .			





G

GS1 DataBar			
All On *  M10054_01	All Off  M10055_01	Omnidirectional and truncated On  M10057_03	Omnidirectional and truncated Off  M10355_02
Stacked and omnidirectional On  M10058_03	Stacked and omnidirectional Off  M10353_03		
GS1 DataBar Expanded			
On  M10059_03	Off  M10417_02	Stacked On  M10357_02	Stacked Off  M10356_02
GS1 DataBar Limited			
On  M10056_03	Off  M10354_02		



H

Han Xin			
On  M10248_01	Off *  M10249_01		
Hong Kong 2 of 5			
On  M10079_01	Off *  M10078_02		

I

Int 2 of 5			
On *  M10060_01	Off  M10061_01	Only codes with checksum On  M10235_01	Only codes with checksum Off *  M10234_01
Without output of checksum On  M10065_01			

J

Japan Post			
On  M10292_02	Off *  M10293_02		

K

KIX Code (Dutch Post)			
On  M10290_02	Off *  M10291_02		
Korean Post			
On  M10358_01	Off *  M10359_01		



M

Maxicode			
On M10067_02	Off * M10066_01		
Matrix 2 of 5			
On M10069_01	Off * M10068_01		
Micro PDF417			
On M10073_01	Off * M10072_01		
MSI Plessey			
On M10076_01	Off * M10077_01		





N

NEC 2 of 5			
On M10082_01	Off * M10083_01		



P

PDF417			
On * M10070_01	Off M10071_01		
Pharmacode			
On M10275_02	Off * M10274_03	Reading from left to right M10281_02	Reading from right to left M10280_02
Plessey			
On M10237_02	Off * M10236_02		



Q

QR Code			
<p>On *</p>  <p>M10095_03</p>	<p>Off</p>  <p>M10096_02</p>	<p>Normal, inverted (light on a dark background), mirrored, model 1</p> <p>On</p>  <p>M10101_02</p>	<p>Normal, inverted (light on a dark background), mirrored, model 1</p> <p>Off</p>  <p>M10351_03</p>







R

RM4SCC (Royal Mail)			
<p>On</p>  <p>M10294_02</p>	<p>Off *</p>  <p>M10295_02</p>		





S

Straight 2 of 5			
<p>On</p>  <p>M10241_01</p>	<p>Off *</p>  <p>M10240_01</p>		





















T

Telepen			
<p>On</p>  <p>M10103_01</p>	<p>Off *</p>  <p>M10104_01</p>		
Trioptic			
<p>On</p>  <p>M10041_01</p>	<p>Off *</p>  <p>M10040_01</p>	<p>Reverse order of code halves</p> <p>On</p>  <p>M10446_01</p>	<p>Reverse order of code halves</p> <p>Off</p>  <p>M10445_01</p>

U

UPC (Universal Product Code)			
<p>UPC-A, UPC-E, EAN-8, EAN-13</p> <p>On *</p>  <p>M10105_01</p>	<p>UPC-A, UPC-E, EAN-8, EAN-13</p> <p>Off</p>  <p>M10106_01</p>	<p>Convert UPC-E to UPC-A</p> <p>On</p>  <p>M10108_01</p>	<p>Convert UPC-E to UPC-A</p> <p>Off *</p>  <p>M10107_01</p>



<p>UPC-A numbering system output On *</p>  <p>M10477_01</p>	<p>UPC-A numbering system output Off</p>  <p>M10478_01</p>	<p>UPC-A check digit output On *</p>  <p>M10475_01</p>	<p>UPC-A check digit output Off</p>  <p>M10476_01</p>
<p>UPC-E numbering system output On *</p>  <p>M10481_01</p>	<p>UPC-E numbering system output Off</p>  <p>M10482_01</p>	<p>UPC-E check digit output On *</p>  <p>M10479_01</p>	<p>UPC-E check digit output Off</p>  <p>M10480_01</p>
<p>Convert UPC-A to EAN-13 On</p>  <p>M10490_01</p>	<p>Convert UPC-A to EAN-13 Off *</p>  <p>M10489_01</p>	<p>Output of UPC-2- and UPC-5- additional codes On</p>  <p>M10110_01</p>	<p>Output of UPC-2- and UPC-5- additional codes Off *</p>  <p>M10109_01</p>
<p>For other settings, see EAN-8 and EAN-13.</p>			
<p>UPU ID tag (Universal Postal Union)</p>			
<p>On</p>  <p>M10360_02</p>	<p>Off</p>  <p>M10361_02</p>		
<p>USPS Intelligent Mail</p>			
<p>On</p>  <p>M10286_02</p>	<p>Off</p>  <p>M10287_02</p>		
<p>USPS Planet</p>			
<p>On</p>  <p>M10284_02</p>	<p>Off</p>  <p>M10285_02</p>		
<p>USPS Postnet</p>			
<p>On</p>  <p>M10282_02</p>	<p>Off</p>  <p>M10283_02</p>		

4.6 Reading Firmware Version and Serial Number

To read the handheld reader's firmware version and serial number, scan the following code using the handheld reader.



M10157_01

To read the firmware version and serial number for the charger or modem, scan the following code using the handheld reader.



M10158_01

The read result is in the following format:

iVVVVVWWWXXXXSSSSSSSSSSAODYYYHHIIIIJJJKKKLLLL<TAB>Z...Z

Abbreviation	Description
i	Internal ID
VVVV	Version number of application firmware
WWW	Version number of bootloader firmware
XXXX	Version number of Bluetooth firmware
SSSSSSSS	Serial number of the handheld reader
A	Current execution state A: processor is running B: undefined state C: undefined state
OO	OEM designation
D	Display type 0 or N: no display D: standard display
YYYY	Version number of the flash file system
HH	Version number of the hardware revision
IIII	Hardware type designation 0008 indicates OHV100-F222
JJJJ	Version number of the boot application
KKKK	Version number of the operating system kernel
LLLL	Version number of the root file system
<TAB>	ASCII TAB character
Z...Z	Version number of the OEM decoder

5 Operation

5.1 Reading Codes

The handheld reader reads both very small 2-D codes (e.g., Data Matrix codes) and larger 1-D codes (e.g., barcodes). The handheld reader offers a field of vision comprising two areas that can be read at the same time. This covers a read range between 4 cm and 31 cm. The optimal read range is 10 cm.

By default, the read range is indicated by two blue bars. However, you can deactivate the display of the blue bars.



Tip

If several codes are located right next to each other, we recommend you cover the codes that you do not wish to read. This prevents you from inadvertently reading another code.



Reading Codes

The handheld reader registers itself with other devices as an input device or keyboard. Before you read a code, start or activate the application to which the read result is to be transferred.

1. To read the code, hold the trigger button down.
2. Position the blue bars in the center of the code that you wish to read. Move the handheld reader closer to or farther away from the code until the height of the blue bars roughly corresponds to the height of the code.

↳ If the reading process is successful, the function indicator on the handheld reader briefly lights up green. When activated, an audible signal is emitted and the handheld reader vibrates.

6 Maintenance

To get the best possible performance out of your device, keep the optical unit on the device clean and clean it when necessary.

Observe the following instructions when cleaning:

- Do not touch the optical unit with your fingers.
- Do not immerse the device in water. Do not spray the device with water or other fluids.
- Do not use a scouring agent to clean the surface of the device.
- Use a cotton or paper cloth moistened with water or isopropyl alcohol (not soaked).
- Remove any residual alcohol using a cotton or paper cloth moistened with distilled water (not soaked).
- Wipe the device surfaces dry using a lint-free cloth.

7

Troubleshooting



Note!

Do not repair, modify, or manipulate the device.



If there is a defect, the device must be repaired by Pepperl+Fuchs.

Fault Repair

Fault	Possible Cause	Remedy
Codes could not be read.	The optical unit on the handheld reader is dirty.	Clean the optical unit. See chapter 6
	The reading distance is too large or too small.	Move the handheld reader closer to or farther away from the code, until the height of the blue bars roughly corresponds to the height of the code. See chapter 5.1
	The code is positioned on a reflective surface.	Activate the option for better display reading. See chapter 4.5.2 Change the reading angle by holding the handheld reader in an inclined position in relation to the surface.
	Reading of the code type is deactivated.	Activate the code type using Vision Configurator (see chapter 4.4.7, see chapter 4.4.8) or the relevant control code (see chapter 4.5.7).
The read result is not being transferred.	The handheld reader is not in the correct operating mode.	Activate a suitable operating mode. <ul style="list-style-type: none"> ■ Docking mode: see chapter 4.2.1 ■ Bluetooth mode: see chapter 4.2.2 ■ Tablet mode: ■ Configuration mode: see chapter 4.2.4
The read result is incorrect.	The handheld reader is using the wrong keyboard layout.	Change the keyboard layout for the current operating mode. See chapter 4.2.5
	The code type is incorrectly interpreted as another code type.	Use the Test statistics area in Vision Configurator to determine which code type the code is being read as (see chapter 4.4.4). Deactivate all code types that are not needed using Vision Configurator (see chapter 4.4.7, see chapter 4.4.8) or the relevant control code (see chapter 4.5.7).
	The read result is altered by a script, code type details, a prefix, or a suffix.	Use the Parameter area in Vision Configurator to check the settings for Read result (see chapter 4.4.12) and Script (see chapter 4.4.13).

2016-05

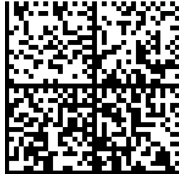
Fault	Possible Cause	Remedy
The connection to Vision Configurator cannot be established.	The handheld reader is not in configuration mode.	Activate configuration mode. See chapter 4.2.4
	The charger's Bluetooth function is activated.	To deactivate the charger's Bluetooth function, move the slider on the back/underside of the charger in the opposite direction to the arrow. See chapter 4.2.4
No data is transferred in docking mode.	The charger's Bluetooth function is activated.	To deactivate the charger's Bluetooth function, move the slider on the back/underside of the charger in the opposite direction to the arrow. See chapter 4.2.1

Fault	Possible Cause	Remedy
No data is transferred in Bluetooth mode.	The charger's Bluetooth function is deactivated.	To activate the charger's Bluetooth function, move the slider on the back/underside of the charger in the direction of the arrow and then activate Bluetooth mode again. See chapter 4.2.2
	The handheld reader is outside the detection range of the Bluetooth receiver.	Move the handheld closer to the charger or Bluetooth modem. If the connection is not automatically reestablished, scan the Quick Connect code on the front of the charger or the modem. To be able to read codes outside of the detection range of the Bluetooth receiver when in Bluetooth mode, scan the following code.  <small>M10186_04</small> Codes that you read while outside the detection range of the Bluetooth receiver will then be saved on the handheld reader. As soon as the connection to the Bluetooth receiver is reestablished, the codes from the handheld reader's memory will be transferred via Bluetooth. If the connection is not automatically reestablished, scan the Quick Connect code on the front of the charger or the modem.
Some settings will be lost when the device is switched off and on again.	The altered settings have not been saved.	Change the settings again and then read the following code to save the settings manually.  <small>M10159_01</small>

Performing a Hardware Reset Using a Control Code

To reset the handheld reader, scan the following code.



CC002943_2



Hardware Reset

As an alternative to reading the control code, you can reset the handheld reader using the trigger buttons.

1. Move the locking device on the bottom of the handheld reader in the direction of the arrow and remove the battery.
2. Press and hold both trigger buttons on the top of the handheld reader.
3. Insert the battery into the handheld reader and continue to hold down the trigger buttons. After approx. ten seconds, five audible signals will sound.
4. Then release the trigger buttons.
 - ↳ The function indicator on the handheld reader will flash green.
5. Press and hold both trigger buttons on the top of the handheld reader again. After around five seconds, one audible signal will sound.
6. Then release the trigger buttons.
 - ↳ The handheld reader has now been restored to its default settings.

FACTORY AUTOMATION – SENSING YOUR NEEDS



Worldwide Headquarters

Pepperl+Fuchs GmbH
68307 Mannheim · Germany
Tel. +49 621 776-0
E-mail: info@de.pepperl-fuchs.com

USA Headquarters

Pepperl+Fuchs Inc.
Twinsburg, Ohio 44087 · USA
Tel. +1 330 4253555
E-mail: sales@us.pepperl-fuchs.com

Asia Pacific Headquarters

Pepperl+Fuchs Pte Ltd.
Company Registration No. 199003130E
Singapore 139942
Tel. +65 67799091
E-mail: sales@sg.pepperl-fuchs.com

www.pepperl-fuchs.com

 **PEPPERL+FUCHS**
SENSING YOUR NEEDS