

MANUAL

SmartRunner Detector

Laser-line triangulation sensor
for high-precision
field monitoring



With regard to the supply of products, the current issue of the following document is applicable: The General Terms of Delivery for Products and Services of the Electrical Industry, published by the Central Association of the Electrical Industry (Zentralverband Elektrotechnik und Elektroindustrie (ZVEI) e.V.) in its most recent version as well as the supplementary clause: "Expanded reservation of proprietorship"

1	Introduction.....	5
1.1	Content of this Document	5
1.2	Target Group, Personnel.....	5
1.3	Symbols Used	5
2	Product Specifications.....	7
2.1	Use and Application.....	7
2.2	Dimensions.....	10
2.3	Laser Class 1	11
2.4	Indicators and Operating Elements	12
2.5	Interfaces	13
2.6	Accessories	14
2.7	Storage and Disposal	14
3	Installation.....	15
3.1	Mounting.....	15
3.2	Detection Range.....	18
3.3	Electrical Connection	18
4	Commissioning.....	21
4.1	Configuration Mode	21
5	Operation.....	24
5.1	Communication via the RS-485 Interface	24
5.1.1	Request Telegram.....	24
5.1.2	Response Telegram.....	25

6	Vision Configurator Software	27
6.1	Menu Bar	27
6.1.1	File Menu	27
6.1.2	View Menu	28
6.1.3	Sensor Menu	28
6.1.4	Image Menu	29
6.1.5	Administration Menu	29
6.1.6	Help Menu.....	30
6.2	Connecting to Vision Configurator	30
6.3	Toolbar.....	31
6.4	Image Display	32
6.5	Sensor Information.....	34
6.6	Common	35
6.7	Detection	36
6.8	Generating Control Codes	37
6.9	Setting Device Parameters via Control Code	38
7	Maintenance.....	39

1 Introduction

1.1 Content of this Document

This document contains information required to use the product in the relevant phases of the product life cycle. This may include the following:

- Product identification
- Delivery, transport, and storage
- Assembly and installation
- Commissioning and operation
- Maintenance and repair
- Troubleshooting
- Dismounting
- Disposal

The documentation comprises the following parts:

- Present document
- Datasheet

In addition, the documentation may comprise the following parts, if applicable:

- EC-Type Examination Certificate
- EC Declaration of Conformity
- Attestation of conformity
- Certificates
- Control drawings
- Other documents

1.2 Target Group, Personnel

Responsibility for planning, assembly, commissioning, operation, maintenance, and dismounting lies with the plant operator.

Only appropriately trained and qualified personnel may carry out mounting, installation, commissioning, operation, maintenance, and dismounting of the product. The personnel must have read and understood the instruction manual and the further documentation.

Prior to using the product make yourself familiar with it. Read the document carefully.



1.3 Symbols Used

This document contains symbols for the identification of warning messages and of informative messages.

Warning Messages

You will find warning messages, whenever dangers may arise from your actions. It is mandatory that you observe these warning messages for your personal safety and in order to avoid property damage.

Depending on the risk level, the warning messages are displayed in descending order as follows:



Danger!

This symbol indicates an imminent danger.

Non-observance will result in personal injury or death.



Warning!

This symbol indicates a possible fault or danger.

Non-observance may cause personal injury or serious property damage.



Caution!

This symbol indicates a possible fault.

Non-observance could interrupt the device and any connected systems and plants, or result in their complete failure.

Informative Symbols



Note!

This symbol brings important information to your attention.



Action

This symbol indicates a paragraph with instructions. You are prompted to perform an action or a sequence of actions.



2 Product Specifications

2.1 Use and Application

The SmartRunner laser-line triangulation sensor creates a high-precision 2-D height profile of an object at near range. For this purpose, a laser line is projected onto an object and is detected by a camera at a specific angle. Height and width information are determined using the triangulation principle.

Example

Raised Profile

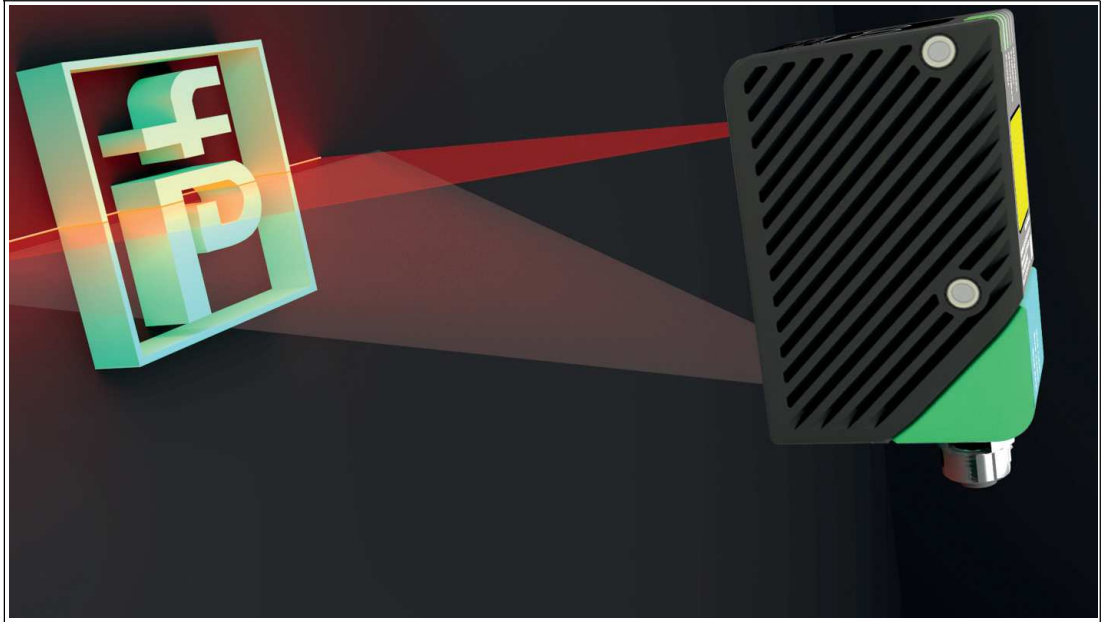

Figure 2.1

Measurement Result

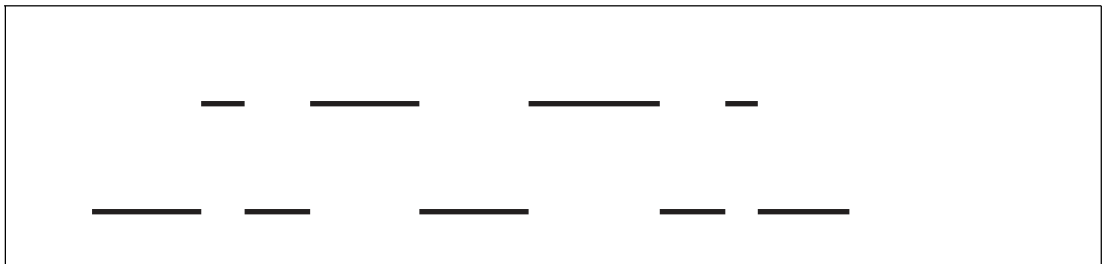

Figure 2.2



Flat Profile

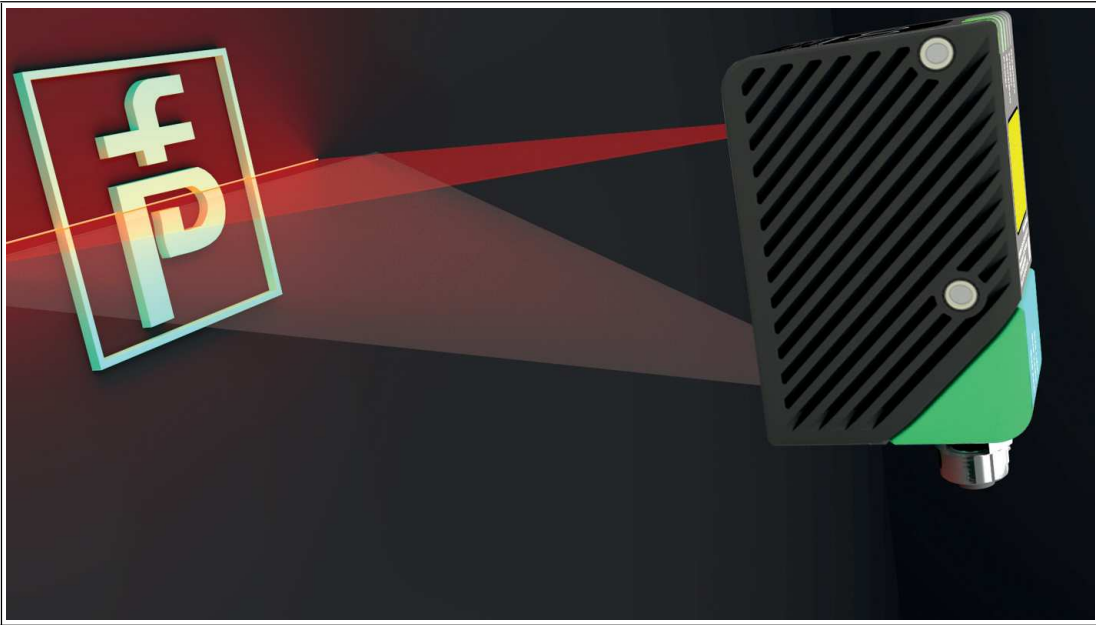

Figure 2.3

Measurement Result

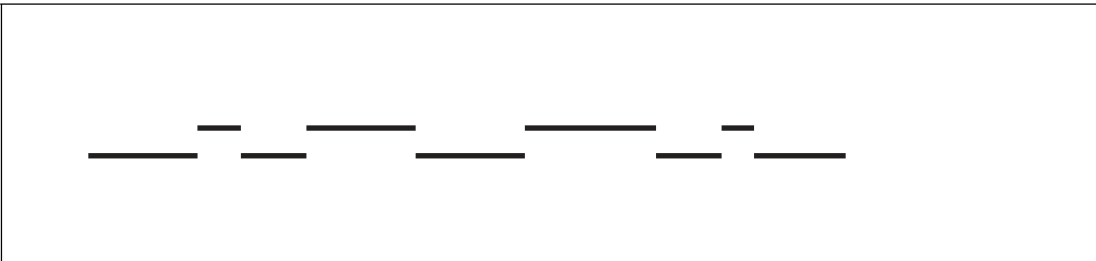

Figure 2.4

The SmartRunner has an optimized hardware and software platform. It is available in different versions for specific applications. The device is certified according to laser protection class 1.

SmartRunner Detector

The detector monitors a defined area. To do so, the laser projects a high-precision light grid onto the previously configured area. Objects < 1 mm can be detected by the high resolution. Even small projections can be detected precisely.

Example application:

High-precision monitoring of a work area.

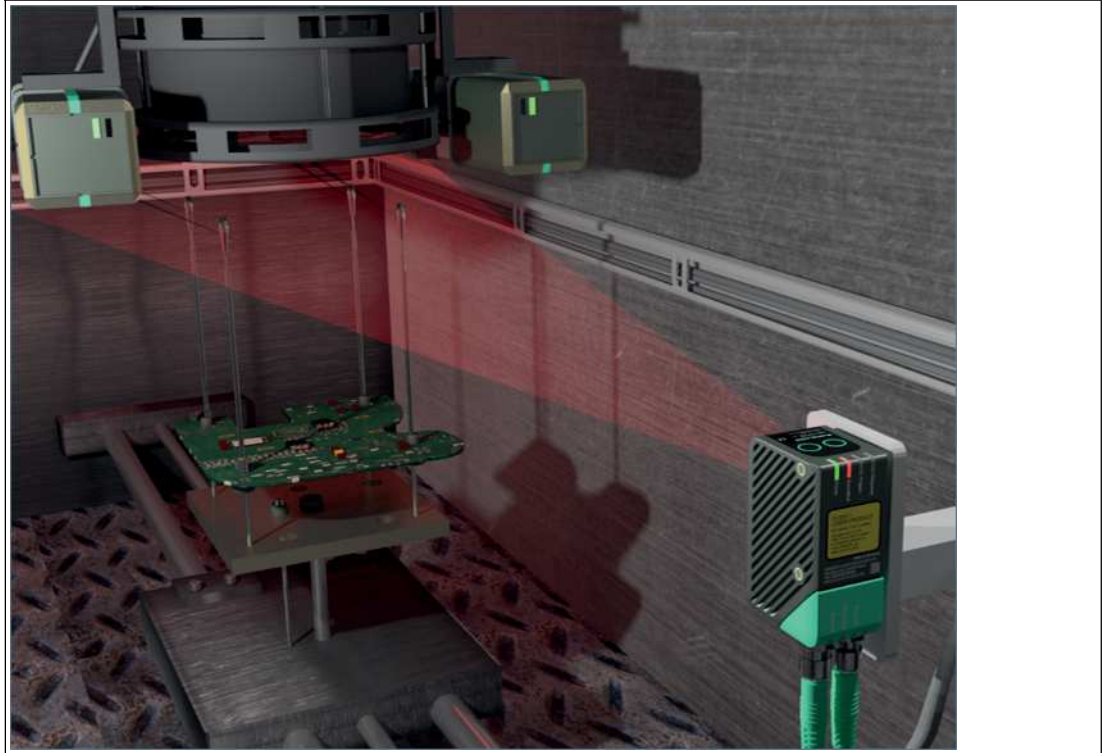

Figure 2.5

In order to accurately consider the boundary conditions and local circumstances of an application, the laser-line triangulation sensor must be taught-in for each individual application. The evaluation of an environment can be either continual (independent) or initiated by a trigger signal.



Parameterization and Operating Modes

The laser-line triangulation sensor can be configured or parameterized via 3 different methods.

- Reading in code cards via the sensor camera
- Processing configuration telegrams via the bus interface
- Using the Vision Configurator software

The sensor has different operating modes, which can be activated for configuration, presentation, or normal operation.

- Normal mode: measurement mode, sensor works as configured
- Configuration mode: mode for configuring the sensor via data telegrams and via the Vision Configurator configuration program
- Code card mode: mode for configuring the sensor via Data Matrix control codes without the assistance of a PC
- Presentation mode: mode for presentation or testing without the assistance of a PC

2.2 Dimensions

The devices in the SmartRunner series have the following identical housing dimensions.

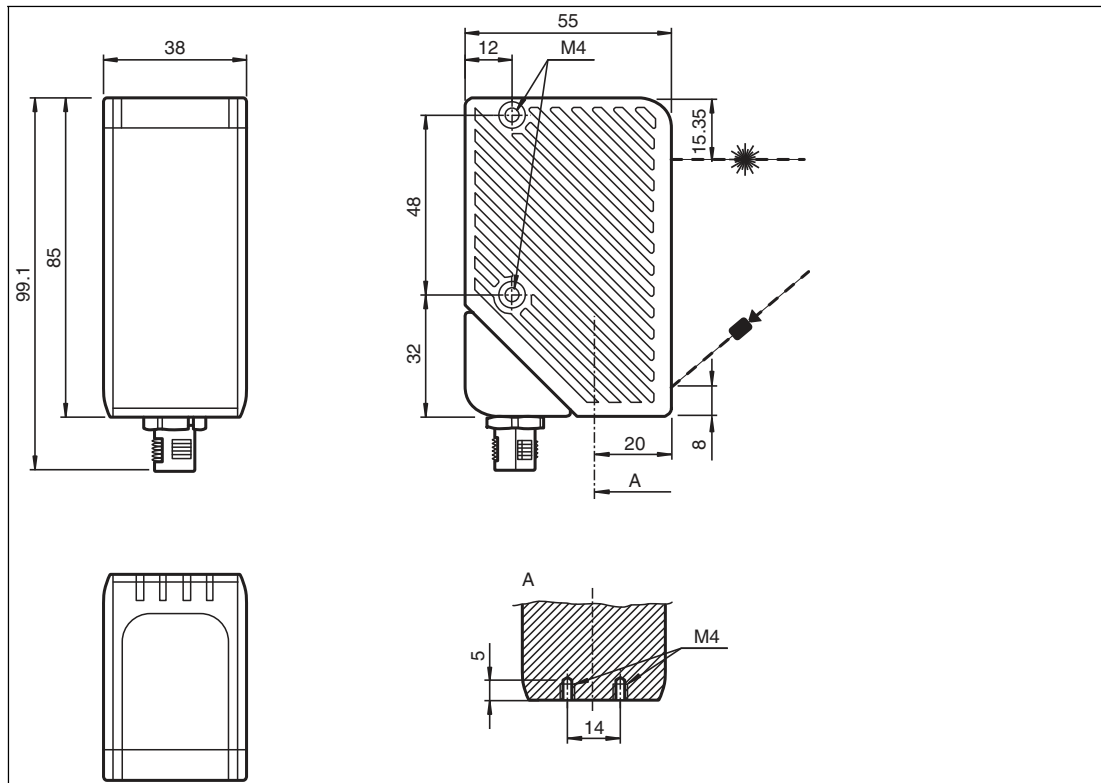

Figure 2.6 Dimensions of the SmartRunner series

2.3 Laser Class 1

This sensor is certified according to laser protection class 1.



Warning!

Class 1 laser light

The laser light can be an irritant, especially in a dark environment. Do not point lasers at people!

Maintenance and repairs must be carried out by authorized service personnel only!

Install the device so that the warning is clearly visible and readable.

Caution: Using controls or adjustments, or performing procedures other than those specified herein may result in harmful laser beam exposure.



2.4 Indicators and Operating Elements

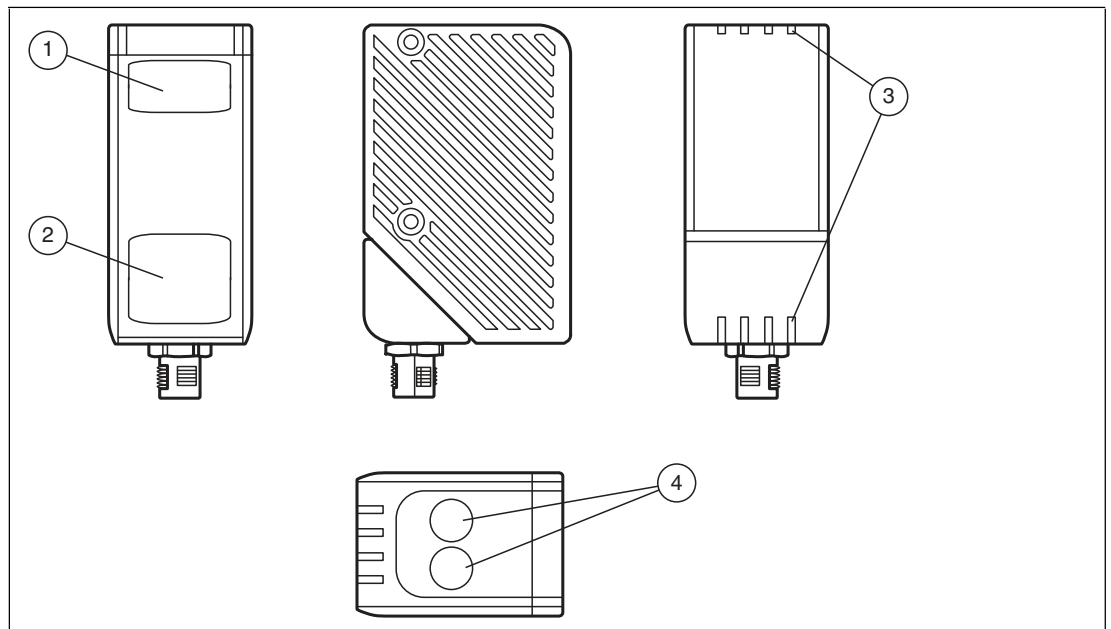

- ① Laser unit (laser protection class 1)
- ② Camera unit
- ③ LEDs
- ④ Function buttons:
Button 1
Button 2



Note!

The function buttons are only activated during a parameterizable time span after the sensor is switched on, following which they are locked. The default value for this time span is 5 minutes. The function buttons have different functions depending on the selected operating state.

Description of the Function Buttons

In presentation mode, the following applies:

- Button 1: triggers an evaluation.
- Button 2: when pressed and held for up to 2 seconds, activates the teach-in process. When pressed and held for longer than 2 seconds, activates code card mode.

In normal mode, the following applies:

- Button 1: no function
- Button 2: when pressed and held for longer than 2 seconds, activates code card mode

Description of LEDs

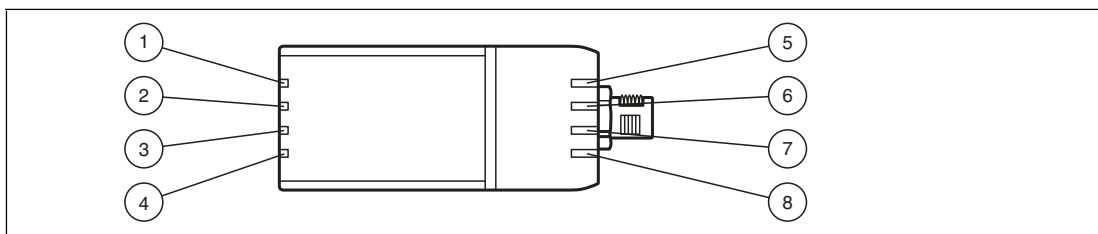

- ① Ready: (green/red)
 - Lights up red if there is a sensor fault.
 - Lights up green if the sensor is ready for operation.
 - Flashes green if the sensor is in configuration mode.
 - Flashes green rapidly if the sensor is in code card mode.
- ② Teach-in: (yellow)
 - Lights up yellow during the teach-in process.
- ③ Result: (green/red)
 - Lights up red when an object has been detected and/or the background line has been interrupted.
 - Lights up green when the background line is not interrupted; no object has been detected.

When the sensor is in code card mode:

 - Lights up green when a correct code has been read.
 - Lights up red when an incorrect code has been read.
 - Off if no code has been read.
- ④ Trigger: (yellow)
 - Lights up yellow if the hardware trigger signal is activated.
- ⑤ Diagnosis: (red)
 - Lights up red if a bus error has occurred.
 - Lights up red if a system error has occurred on the interface controller.
 - Flashes red if the sensor is in update mode.

- ⑥ POWER: (green)
 - Lights up green as soon as voltage is present
- ⑦ Background: (green)
 - Lights up green if output 1 is set.
- ⑧ Object: (yellow)
 - Lights up yellow if output 2 is set.

During the boot process, all of the LEDs light up until the normal operating state has been reached.

2.5 Interfaces

The RS-485 Interface

The reader is equipped with an RS-485 interface for communication purposes, i.e., parameterizing the reader functions or reading out current process data during operation. This interface is operated in 8-E-1 mode and fitted with a terminator that can be activated or deactivated by parameterizing the sensor head accordingly.

The RS-485 interface supports the following transfer rates:

- 38400 bit/s
- 57600 bit/s
- 76800 bit/s
- 115200 bit/s (default value)
- 230400 bit/s

Data structure of the RS-485 interface

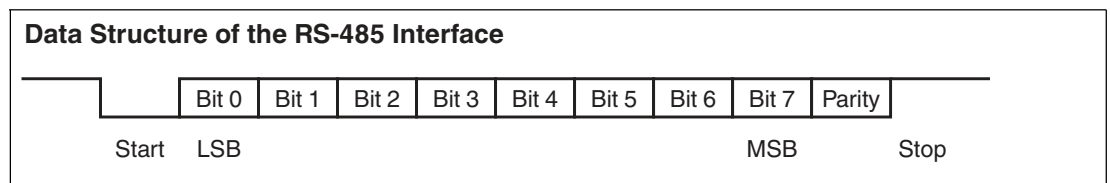

2.6 Accessories

Order designation	Description
V19-G-5M-PUR-ABG	Single-ended female cordset, M12, 8-pin, shielded, PUR cable

2.7 Storage and Disposal

Keep the original packaging. Always store and transport the device in the original packaging.

Store the device in a clean and dry environment. The permitted ambient conditions must be considered, see datasheet.

Disposing of device, packaging, and possibly contained batteries must be in compliance with the applicable laws and guidelines of the respective country.

3 Installation

3.1 Mounting

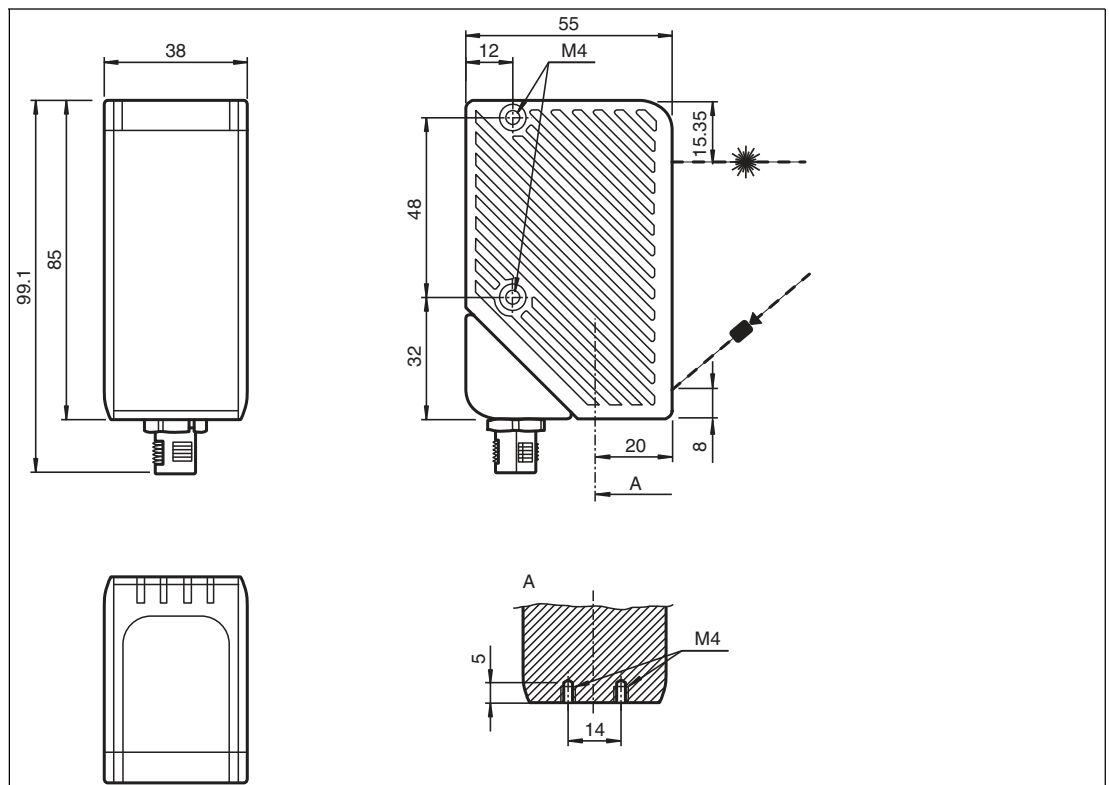

Figure 3.1



Caution!

Damage to Equipment

The threads in the bores at the side and on the underside of the housing are not thru-holes.

Observe the maximum permissible screw-in depth to avoid damaging the device or mounting incorrectly. Do not overtighten the screws. The maximum torque of the mounting screws must not exceed 2 Nm.

Mounting the Housing

There are 3 different ways of installing the housing of the SmartRunner in your plant.

- One-sided lateral mounting with M4 screws: You can mount the housing on its right-hand or left-hand side using the 2x M4 threaded sleeves. The maximum screw-in depth of the M4 screws is 8 mm.
- Continuous lateral mounting with M3 screws: M4 threaded sleeves are designed in such a manner so that M3 screws pass all the way through the housing. Use 2x sufficiently long M3 screws with 2x lock nuts to mount the device in the plant.
- Mounting the underside of the device with M4 screws: You can use the 2x threaded sleeves to mount the underside of the housing. The maximum screw-in depth of the M4 screws is 5 mm.



Positioning

When positioning the SmartRunner, ensure that the camera's field of vision is not covered by the objects being scanned.

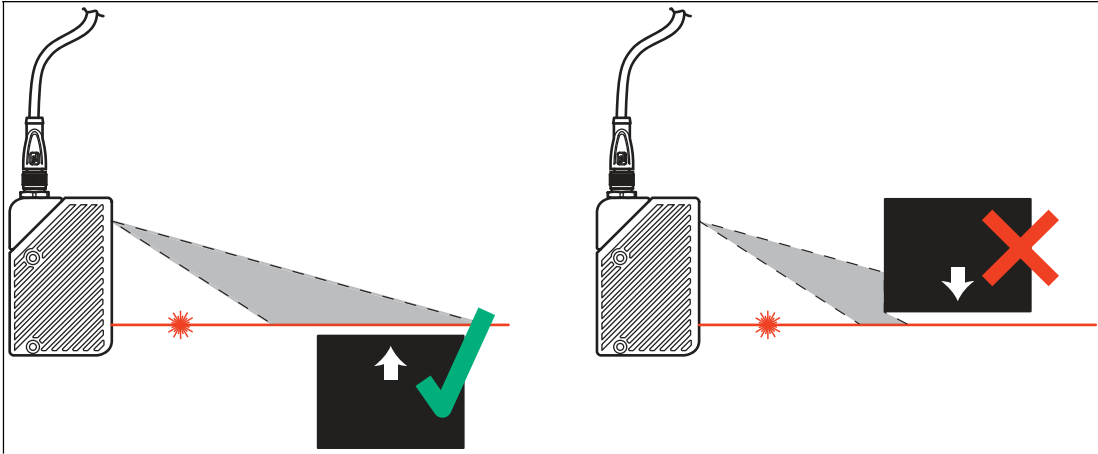

Figure 3.2

If the monitored area is underneath the sensor, the camera must be aligned to the area from above.

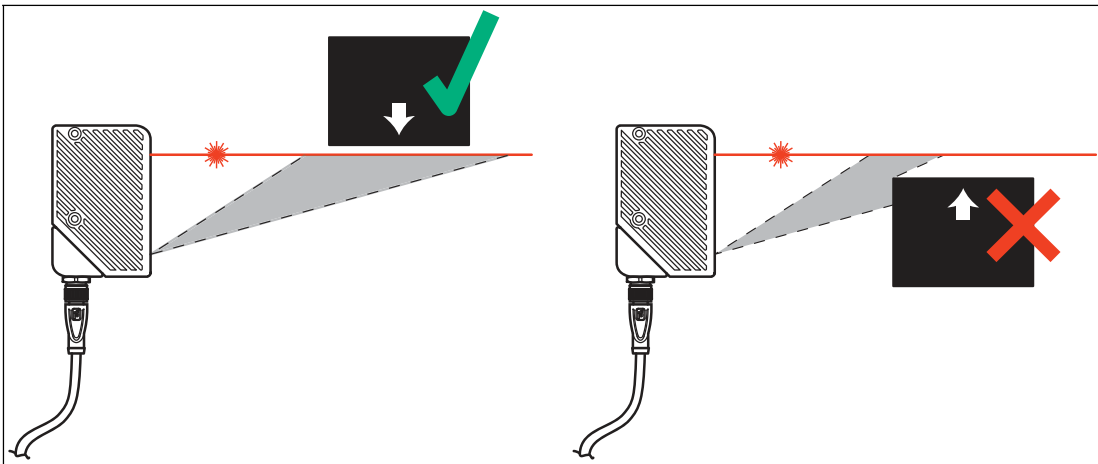

Figure 3.3

If the monitored area is above the sensor, the camera must be aligned to the area from beneath.



Tip

The corner of the housing where the 8-pin M12 connector plug **MAIN** is located can be rotated. Depending on the mounting position, you can rotate the connector plug in a different direction to ensure simple cabling.

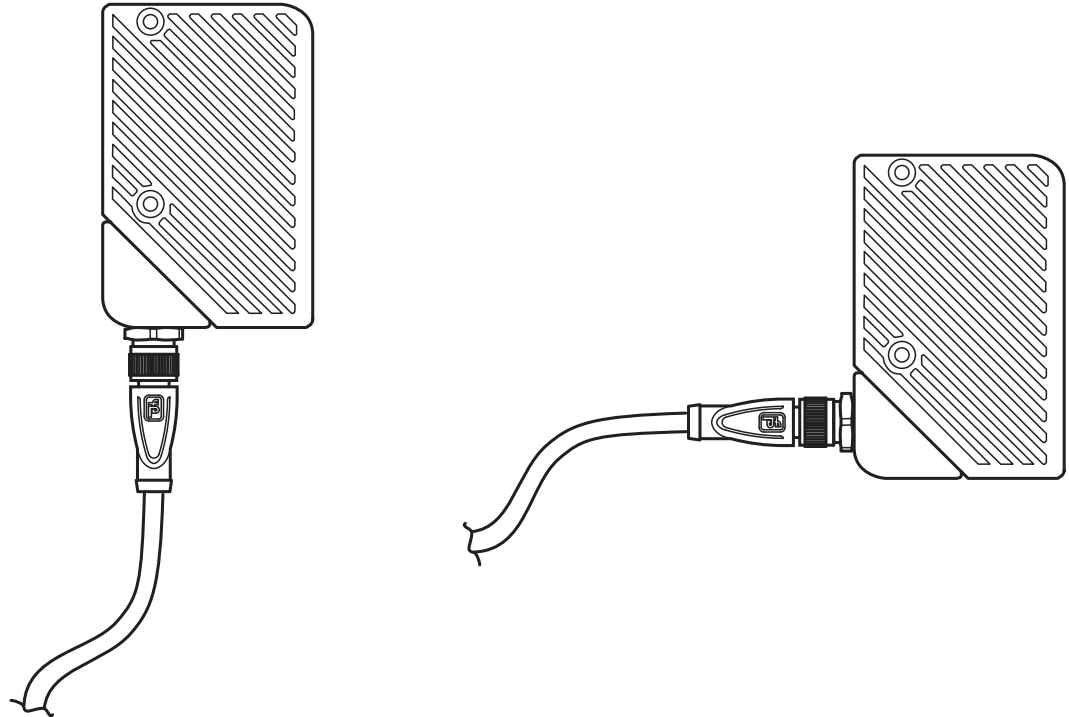
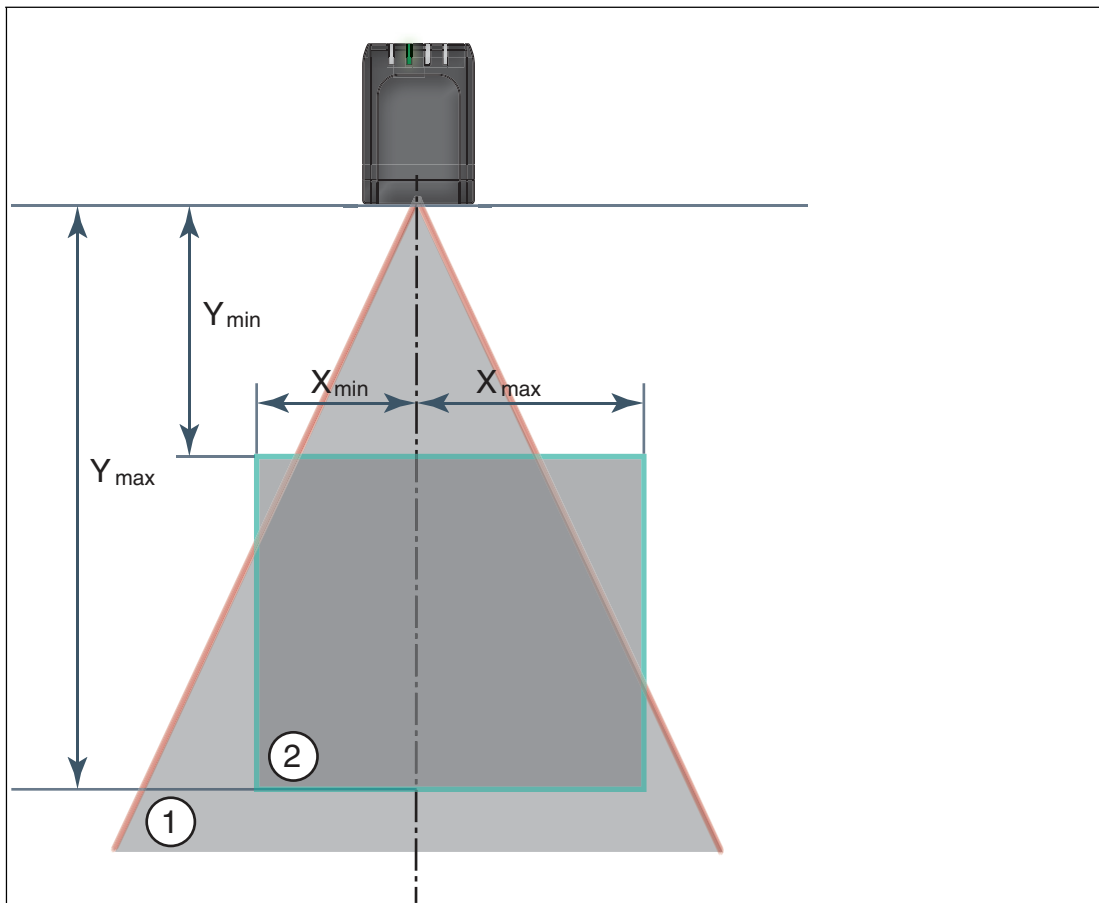

Figure 3.4

3.2 Detection Range



- ① Field of view
- ② Detection range

Note the detection range of the SmartRunner detector when planning your plant. The following table contains information on the detection range and the resolution.

	Detection range X	Distance Y to the sensor	Minimum object size
min	45 mm	55 mm	0.25 mm
max	350 mm	700 mm	1.0 mm



Note!

The smallest possible object size increases linearly with the distance Y to the sensor.

3.3 Electrical Connection

The device is connected electrically via an 8-pin M12 connector plug **MAIN** on the side of the housing. The power supply and data transfer take place via this connection.

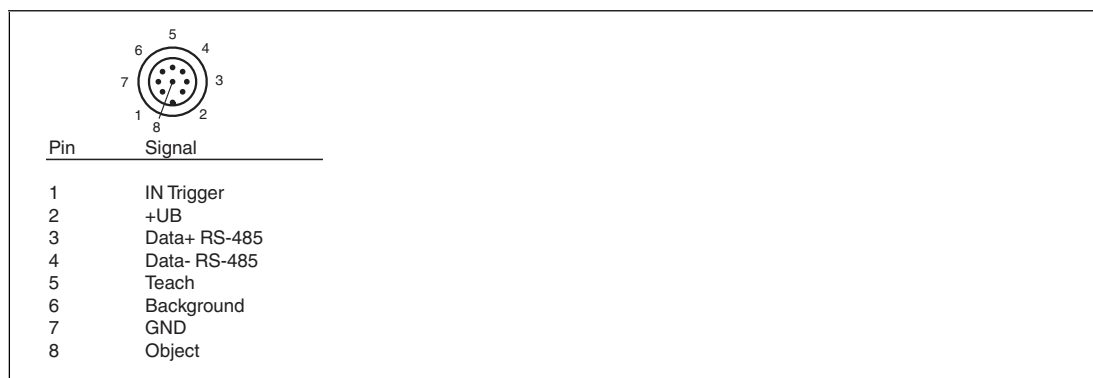

Figure 3.5

Pin	Signal	Description
1	IN trigger	Trigger input. Triggers an evaluation, if the sensor is in continuous evaluation mode (independent)
2	+UB	+ 24 V power supply
3	Data+ RS485	RS485 interface: Data +
4	Data- RS485	RS485 interface: Data -
5	Teach	Control signal for teaching-in the background line and the definition of the search area (ROI)
6	Background	Output 1 is set if the background line is not interrupted
7	GND	Ground for the + 24 V power supply
8	Object	Output 2 is set if the object has been detected



Caution!

Damage to the device

Connecting an alternating current or excessive supply voltage can damage the device or cause the device to malfunction.

Electrical connections with reversed polarity can damage the device or cause the device to malfunction.

Connect the device to direct current (DC). Ensure that the supply voltage rating is within the specified device range. Ensure that the connecting wires on the female cordset are connected correctly.

Shielding Cables

The shielding of connection lines is required to suppress electromagnetic interference. Establishing a low resistance or low impedance connection with the conductor or equipotential bonding circuit is a particularly important factor in ensuring that these interference currents do not become a source of interference themselves. Always use connection lines with braided shield; never use connection lines with a film shield. The shield is integrated at both ends, i.e., in the switch cabinet or on the controller **and** on the read head. The grounding terminal available as an accessory allows easy integration in the equipotential bonding circuit.

In exceptional cases, the shielding of a connection at one end may be more favorable if

- An equipotential bonding cable is not laid or cannot be laid.
- A film shield is used.

The following points relating to shielding must also be noted:

- Use metal cable clips that cover large areas of the shield.
- After installing the cable shield in the control cabinet, place it directly on the equipotential bonding rail.
- Direct the protective grounding connections to a common point in a star configuration.
- The cross-section of the cables used for grounding should be as large as possible.

Additional Ground Connection

Order designation	Description
PCV-SC12	Clip for mounting an additional ground connection.
PCV-SC12A	

4 Commissioning

4.1 Configuration Mode

To adjust the sensor, it must be in configuration mode.

The command to put the sensor in this mode is 0xA8 0x57. After successfully changing mode, the sensor responds with an Acknowledge (0x81 0xAC 0x00 0x2D). After an error when converting the configuration, the sensor responds with a No Acknowledge (0x81 0x53 0xXX 0xYY, where XX = error code and YY = checksum). To check whether the sensor is in configuration mode, the command Is_In_Config_Mode (0x00 0xFE 0xFE) can be sent. If the sensor is in configuration mode, it responds with an Acknowledge, otherwise there is no response.

Error codes with "No Acknowledge":

- 0x00 = everything OK
- 0x01 = checksum incorrect
- 0x04 = parameter has a different length than that transferred
- 0x05 = internal error
- 0x06 = parameter index is unknown
- 0x07 = read/write access, although not allowed
- 0x09 = parameter value range is violated
- 0x0B = other error
- 0x0E = configuration command too long/short

In configuration mode, messages are sent according to the extended protocol:

Byte/ bit	8	7	6	5	4	3	2	1	0
1	Parity	R/W	Length6	Length5	Length4	Length3	Length2	Length1	Length0
2	Parity	Index7	Index6	Index5	Index4	Index3	Index2	Index1	Index0
3	Parity	Data 1.7	Data 1.6	Data 1.5	Data 1.4	Data 1.3	Data 1.2	Data 1.1	Data 1.0
...	Parity
n	Parity	Data (n-2).7	Data (n-2).6	Data (n-2).5	Data (n-2).4	Data (n-2).3	Data (n-2).2	Data (n-2).1	Data (n-2).0
n+1	Parity	xor B1.7...B(n).7	xor B1.6...B(n).6	xor B1.5...B(n).5	xor B1.4...B(n).4	xor B1.3...B(n).3	xor B1.2...B(n).2	xor B1.1...B(n).1	xor B1.0...B(n).0

Table 4.1 R/W:
0: write
1: read/command
Length: row data length (Data1 ... Data(n-2))

Description of Messages

Index	Parameter name	Data Length/bytes	Read/write	Description
0x01	VendorName	Variable	R	String containing "Pepperl+Fuchs"
0x02	VendorHomepage	Variable	R	String containing the Pepperl+Fuchs homepage
0x03	ProductName	Variable	R	String containing the product name
0x07	SoftwareVersionDSP	Variable	R	String containing the version information
0x64	Trigger	-	W	Triggers an image capture with evaluation
0xE0	GetImage	-	W	Loads the current image from the sensor

Index	Parameter name	Data Length/bytes	Read/write	Description
0xFE	InParamMode	-	R	Queries whether the sensor is in parameterization mode
0xF3	Save settings	-	W	Saves the current settings in the flash memory
0xFF	LeaveParamMode	-	W	Request to exit parameterization mode
0x20	Interface_Address	1	R/W	Set the bus address, value range 0-3
0x23	Interface Baudrate	4	R/W	Baud rate int32 little endian in baud (9600 - 230400)
0x25	Termination enable	1	R/W	Enable/disable termination of the RS-485 bus
0x68	Laser exposure time	4	R/W	Sets the exposure time in μ s increments
0x10	Flash time	4	R/W	Sets the exposure time (LED lighting) in μ s
0xFD	Presentation mode	4	R/W	Presentation mode on [0] or off [1]
0x6D	Go to teach mode	-	W	Puts the sensor in teach-in mode
0xC8	ROI Evaluation	16	R/W	"Region of interest" evaluation, 4 bytes in each case: X_{min} , X_{max} , Z_{min} , Z_{max} in mm
0xC6	MinObjectsize	4	R/W	Minimum object size in 0.1 mm increments. All smaller objects are ignored
0xC7	Background tolerance	4	R/W	Tolerance band around the background line in 0.1 mm increments
0x9F	Switching threshold	4	R/W	Sensitivity for object detection in % [0 - 100]
0x51	Autotrigger	4	R/W	Activates the autotrigger function. When enabled, the sensor triggers itself cyclically.



Note!

All values are transferred in little-endian format. This saves the least significant byte at the lowest address, i.e. the least significant component is specified first.

Example

ROI for evaluation: Sets the ROI to ± 50 mm in the X direction and to between +100 mm and +200 mm in the Z direction:

0x 10 C8 CE FF FF FF 32 00 00 00 64 00 00 00 C8 00 00 00 77

0x10 = data length

0xC8 = Index

0xCEFFFFFF = X_{\min} -50 mm (little-endian, two's complement)

0x32000000 = X_{\min} +50 mm (little-endian, two's complement)

0x64000000 = Z_{\min} +100 mm (little-endian, two's complement)

0xC8000000 = Z_{\min} +200 mm (little-endian, two's complement)

Response telegram:

13.02.2017 11:39:17.68 [TX] -80 C8 48

13.02.2017 11:39:17.69 [RX] -90 C8 CE FF FF FF 32 00 00 00 64 00 00 00 C8 00 00 00 F7

5 Operation

5.1 Communication via the RS-485 Interface

The controller and reader communicate via the RS-485 interface during operation. Make sure that the basic communication settings have been made on the reader, such as setting the reader address and baud rate.

A distinction is made between request telegrams that the controller sends to the reader and response telegrams that the reader sends to the controller. Each byte of a request or response telegram consists of 9 bits (8 data bits + 1 parity bit).

5.1.1 Request Telegram

A request telegram always consists of 2 bytes. The second byte corresponds to the first byte, however the 8 data bits of the first byte are inverted.

Structure of a Request Telegram

		Bit 7	Bit 6	Bit 5	Bit 4	Bit 3	Bit 2	Bit 1	Bit 0
Byte 1	Parity	R/W	Req. bit 4	Req. bit 3	Req. bit 2	Req. bit 1	Req. bit 0	A1	A0
Byte 2	Parity	~R/W	~Req. bit 4	~Req. bit 3	~Req. bit 2	~Req. bit 1	~Req. bit 0	~A1	~A0

Meaning of bits:

R/W: 0 = response, 1 = request

Meaning of Bits

8	7	6	5	4	3	2	1	0	<- Bit	
PAR	R/W	R.4	R.3	R.2	R.1	R.0	A.1	A.0	Value	Function
Parity	0	x	x	x	x	x	x	x		Answer
Parity	1	x	x	x	x	x	x	x		Request
Parity	1	x	x	x	x	x	0	0		Read head addr. 0
Parity	1	x	x	x	x	x	0	1		Read head addr. 1
Parity	1	x	x	x	x	x	1	0		Read head addr. 2
Parity	1	x	x	x	x	x	1	1		Read head addr. 3
Parity	1	0	0	0	0	0	x	x	0x80	Status (is alive)
Parity	1	0	0	0	0	1	x	x	0x84	Result data
Parity	1	0	0	1	0	1	x	x	0x94	Teach
Parity	1	0	1	0	1	0	x	x	0xA8	Enable Configuration Mode
Parity	1	1	0	1	1	0	x	x	0xD8	Generate a software trigger

5.1.2 Response Telegram

The response telegram may contain 6 to 9 bytes, depending on the content. The first byte contains the address of the responding reader and status information. The X position of the reader is transmitted in bytes 2 to 5, starting with the MSB. Depending on the controller request, information such as speed and the Y position is transmitted in the subsequent bytes. These bytes are omitted if a corresponding request is not sent. The last byte is used to detect faults during the data transfer.

Status (is alive)

The status always returns 0x55 if the sensor is ready for operation.

	8	7	6	5	4	3	2	1	0
Byte	PAR	R/W	R.4	R.3	R.2	R.1	R.0	A.1	A.0
1	Parity	0	1	0	1	0	1	0	1

Result Data

Result Data provides the measurement status and result as a response.

Byte	Bit 8	Bit 7	Bit 6	Bit 5	Bit 4	Bit 3	Bit 2	Bit 1	Bit 0
Byte 1 - Status	Parity	0	-	Addr 1	Addr 0	Event	WRN	No Pos.	ERR
Byte 2 - Result	Parity	0	0	R5	R4	R3	R2	R1	R0
Byte 3 - Counter	Parity	0	C06	C05	C04	C03	C02	C01	C00
Byte 4 - Checksum	Parity	0	xor	xor	xor	xor	xor	xor	xor

Legend

Status	Addr	Device address
	Event	Event occurred, currently read as 0
	WRN	Unused
	No Pos.	Is always read as 0
	ERR	System error or evaluation error
Result	R0	Faulty background line
	R1	Object detected
	R3	Unused
	R4	Unused
	R5	Unused
Counter		Increments for each evaluation, is restarted at 0x3F

Software Trigger

After sending the sequence for the software trigger, the sensor triggers an image capture. No response telegram is generated to the command.

Teach-In

After sending the sequence for the teach-in, the sensor begins the teach-in routine. No response telegram is generated to the command.

6 Vision Configurator Software

The sensor is commissioned and operated using the Vision Configurator software.

The Vision Configurator software makes it easy to operate the sensor with its user-friendly interface. Standard functions include making connections to the sensor, specifying the operating parameters, saving data sets, and displaying data and error diagnostics.



Note!

The following user roles are predefined with different authorizations in the Vision Configurator.

User Rights and Password

User rights	Description	Password
Default	View all information Sensor configuration Create users at same or lower level	A password is not required
User	View all information Sensor configuration Create users at same or lower level	User



Establishing a Network Connection

To establish a network connection with the sensor, proceed as follows:

1. Supply the sensor with power.
2. Start the Vision Configurator software.
3. Select the connected sensor.
4. Check that the correct RS-485 address and baud rate have been input.
5. Enter your user name and password.

↳ A connection to the sensor is established.

An up-to-date description of the Vision Configurator software can be found at <http://www.pepperl-fuchs.com>.

6.1 Menu Bar

The menu bar contains a list of menu items. The functionality depends on the type of sensor that is connected and the permissions of the user logged in.

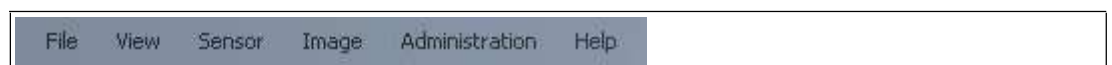

Figure 6.1 Menu Bar



6.1.1 File Menu

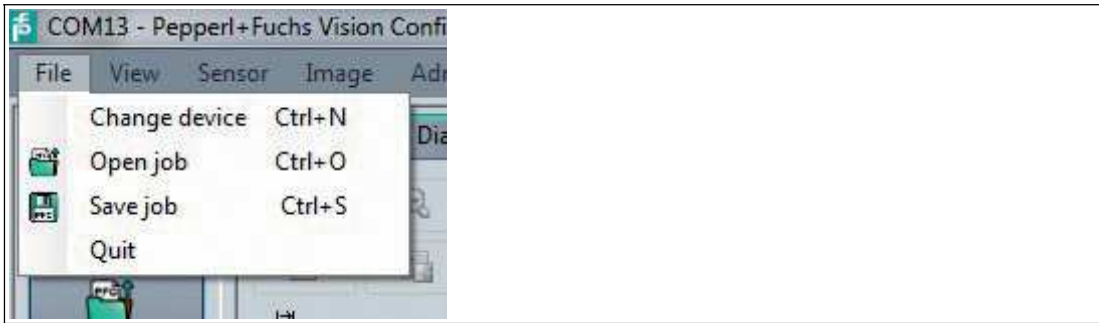

Figure 6.2 File Menu

Change device	Disconnects the device and returns to the Login dialog.
Open job	Loads a sensor configuration stored on the PC.
Save job	Saves the current sensor configuration on the PC.
Quit	Terminates the program.

Table 6.1 File Menu

6.1.2 View Menu



Figure 6.3 View Menu

Show standard buttons	Toggles the display of the buttons in the bar on the left on and off.
Show sensor data	Hides the display of the sensor data in the top right of the screen.

Table 6.2 View Menu

6.1.3 Sensor Menu

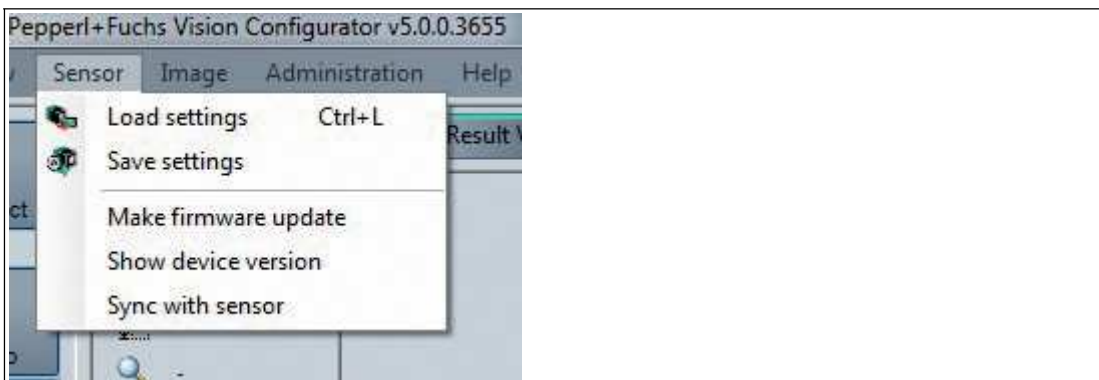

Figure 6.4 Sensor Menu

Load settings...	Loads the saved settings from the sensor
Save settings...	Saves the settings to the sensor

2017-04

Change network settings...	If the sensor is connected to the PC via Ethernet, this command enables you to change some of the connection settings on the sensor. Once you have changed the settings, the connection between Vision Configurator and the sensor is automatically disconnected. If required, change the network address to the newly allocated IP and reconnect Vision Configurator to the sensor. Press the Connect button to open the Login screen again.
Make firmware update...	Performs firmware updates. This command should be used by experienced users only.
Sync with sensor	Synchronization with the sensor

Table 6.3 Sensor Menu



Note!

Firmware Update

Once you have upgraded the firmware and **Update complete** is displayed, restart the sensor.

6.1.4

Image Menu

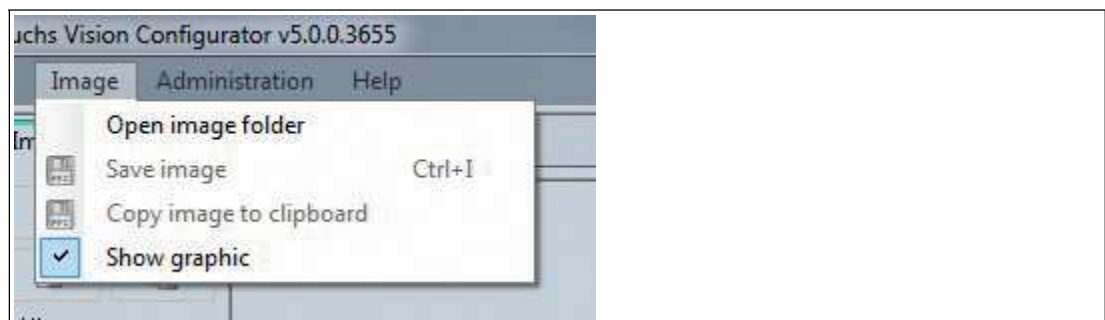

Figure 6.5 Image Menu

Open image folder	Opens the folder in which images are currently saved.
Save image	Saves the image currently displayed on the PC.
Copy image to clipboard	Loads an image file to the clipboard.
Show graphic	Turns display data sent from the sensor on and off in the image.

Table 6.4 Image Menu

6.1.5

Administration Menu



Figure 6.6 Administration Menu



User administration	Opens a window which displays all of the currently created users at the same authorization level or lower. New users with the same authorization level or lower can also be created and deleted here. In addition, a user password can be reset to the default password for the relevant user level.
Change password	Changes the current user's password.
Change user	The Login screen opens and a different user and/or sensor can be selected.
Send XML file...	Saves the XML data on a computer.
Load XML file...	Loads XML data from a computer.
Create reader programming code	Enables the user to create control codes that can assign the sensor a device name and an IP address. ¹

Table 6.5 Administration Menu

1. If required/applicable

6.1.6

Help Menu

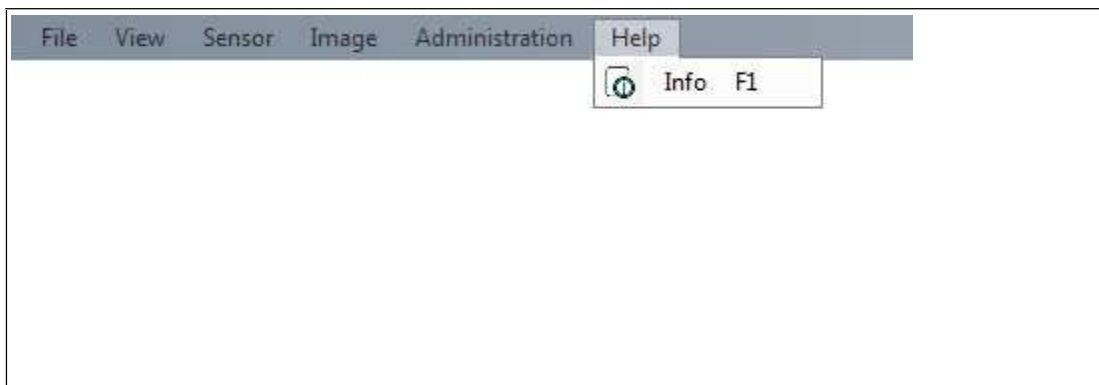

Figure 6.7 Help menu

Info	Displays information about Vision Configurator.
-------------	---

Table 6.6 Help menu

6.2 Connecting to Vision Configurator

Connect the SmartRunner to a PC. Use a suitable RS-485/USB connecting cable and an adapter cable to do this:

Function	Order designation
USB to RS-485 interface converter including cable unit with power supply	PCV-USB-RS485-Converter Set
Cable unit with power supply for USB/RS-485 interface converter	PCV-KBL-V19-STR-RS485

Start Vision Configurator.

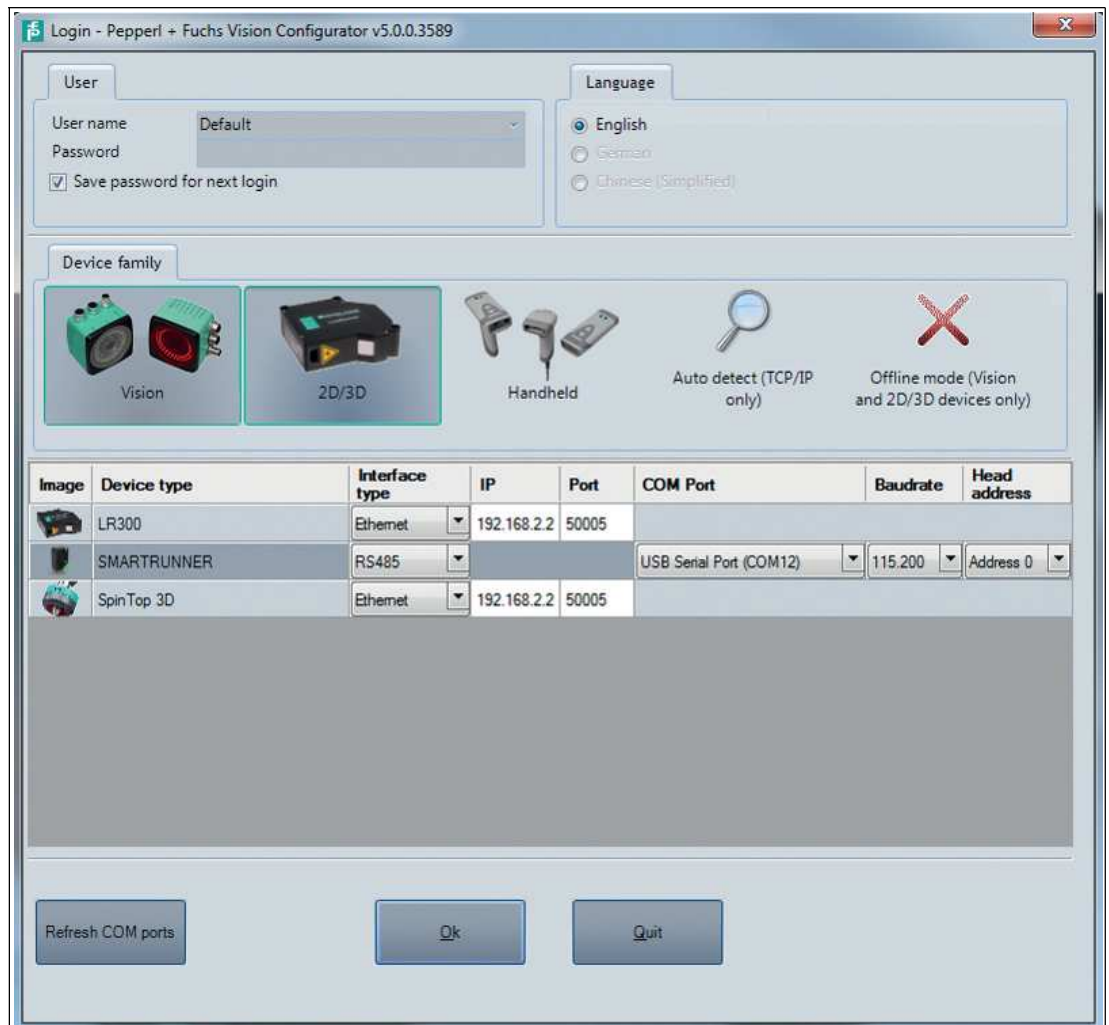





- Select the 2-D/3-D family
- Select "SMARTRUNNER" with connection type "RS485"
- Select the required COM port
- Select the baud rate (default: 115200)
- Select the RS-485 address (default: 0)
- Connect by clicking the "OK" button

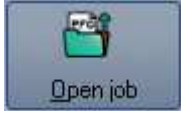

6.3 Toolbar

Using the toolbar, various functions can be called up directly.

 Disconnect	The connection between the PC and the sensor is disconnected.
 Open job	Opens a saved setting.
 Save job	Saves the settings made.
 Load settings	Settings are read out from the sensor.
 Save settings	All settings made are saved on the sensor.

6.4 Image Display

Image View

Displays image data. Selected via the "Image View" button. "Get image" loads the last captured image on the PC and displays it in the window. To capture a new image, "Trigger" must have been clicked.



Figure 6.8 Image View

Diagram View

Displays the results data in graphical form. The results data is retrieved by clicking "Get lines". The most recent results are then retrieved and displayed graphically. The "Get lines" function does not trigger a new image capture and evaluation process. "Trigger" must have been clicked in order to do this.

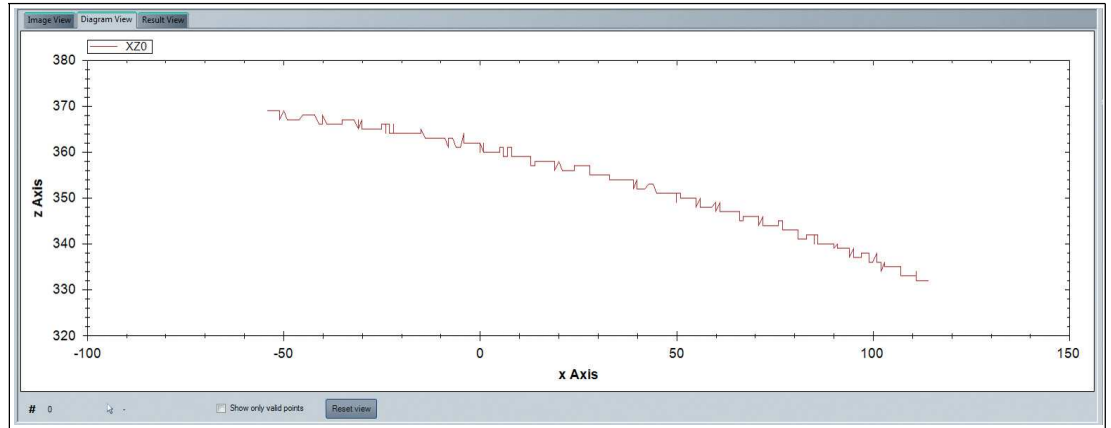

Figure 6.9 Diagram View

Result View

Displays the results of the image evaluation. "Start request" starts the transfer.



Figure 6.10 Result View - Start request

"Stop request" stops the transfer.



Figure 6.11 Result View

6.5

Sensor Information

Sensor Information Tab

Name: "Pepperl+Fuchs GmbH"

Homepage: "http://www.pepperl-fuchs.com/"

Product name: "Smartrunner"

Firmware version: Current firmware version of the main processor.

The version designation as a whole is made up as follows: Major Version.Minor Version.

Tag Number– Revision Number



Figure 6.12 Sensor Information Tab

6.6 Common

Common Tab

The general tab for setting the sensor configuration.

"Communication" Tab



Figure 6.13 Common tab: Communication

- **RS485 head address:** Address in the RS485 bus. The address is sent with every RS-485 command (see chapter on RS-485 communication) and is used for identification purposes if multiple sensors are installed in the bus.
- **Baudrate:** Baud rate with which the sensor communicates via RS-485. When you change the baud rate, the baud rate of the Vision Configurator is also automatically changed, so that communication still remains possible.
- **Bus termination:** Activates the integrated terminating resistor to terminate the RS-485 bus on the sensor

"Trigger" Tab



Figure 6.14 Common tab: Trigger

- **Autotrigger:** Switches the autotrigger function on or off

"Lighting" Tab

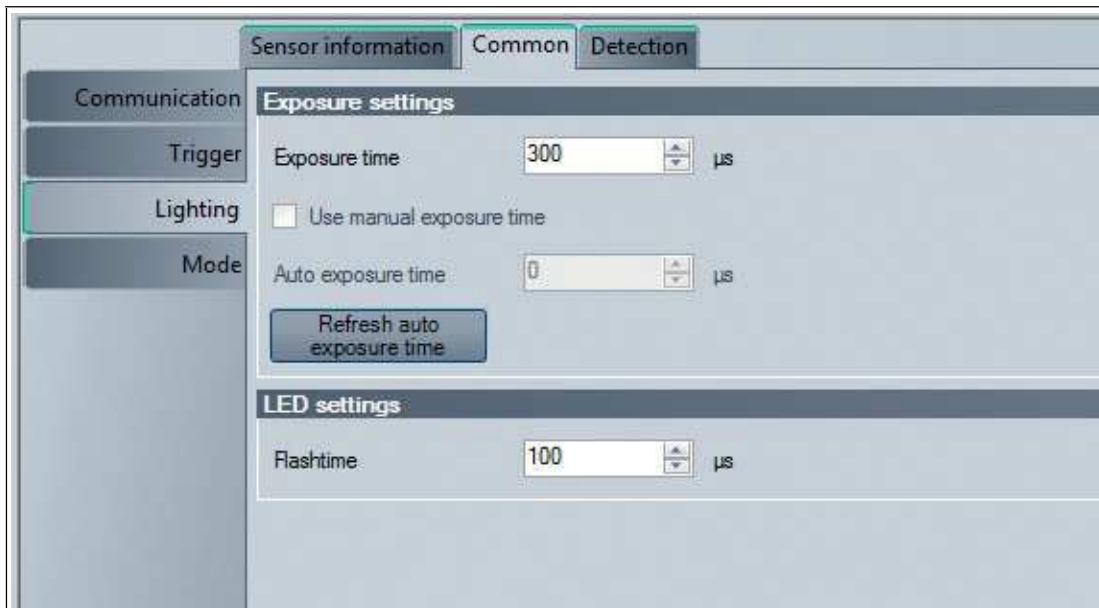

Figure 6.15 Common tab: Lighting

- **Exposure time:** Setting for the manual exposure time. If the "Use manual exposure time" checkbox is deactivated, this value has no significance.
- **"Use manual exposure time"** checkbox: The manually set exposure time is used when this checkbox is activated. If this box is not checked, the exposure time during the teach-in process is controlled automatically.
- **Auto exposure time:** The current exposure time is output in this field.
- **"Refresh auto exposure time"** button: Pressing this button updates the "Auto exposure time" field.

"Mode" Tab



Figure 6.16 Common tab: Mode

- **Presentation mode:** Switches presentation mode on or off

6.7 Detection

Detection Tab

General tab for configuring the camera

"Detection" Tab



Figure 6.17 Detection tab—Detection

- **Minimum object size:** camera setting, adjust the resolution to the object size.

"ROI" Tab

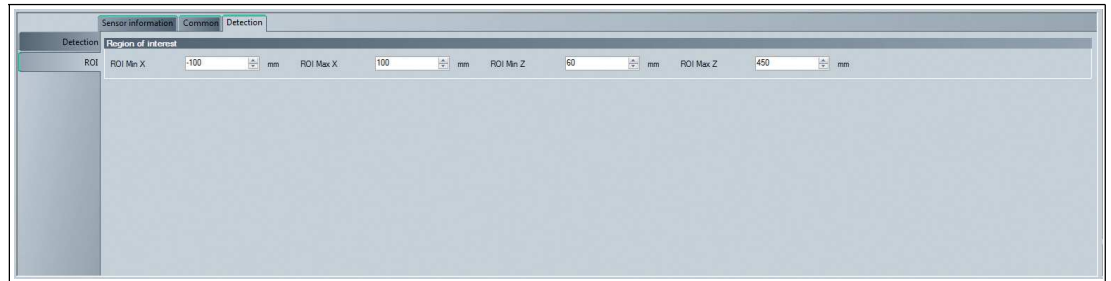

Figure 6.18 Detection tab—region of interest

- **ROI:** defines the detection area

6.8 Generating Control Codes

Using the Vision Configurator software, you can create control codes that can assign a device name and an IP address or an RS-485 address plus baud rate to the sensor.



Tip

It is also possible to generate control codes when no sensor is connected to Vision Configurator. In this case, you can, for example, generate a control code to assign a particular IP address to a sensor and then establish a connection with a PC.



Generating a Control Code

1. In the menu bar, select **Administration > Create reader programming code**.
2. Select the sensor type **SMARTRUNNER** from the **Device type** section.
3. Select the required parameter in the **Select function** section.
 - ↳ The control code is displayed in different sizes in the **Control Code** section.
4. To print the control code, click **Print** or **Print preview**.
To save the control code, click **Save image**.

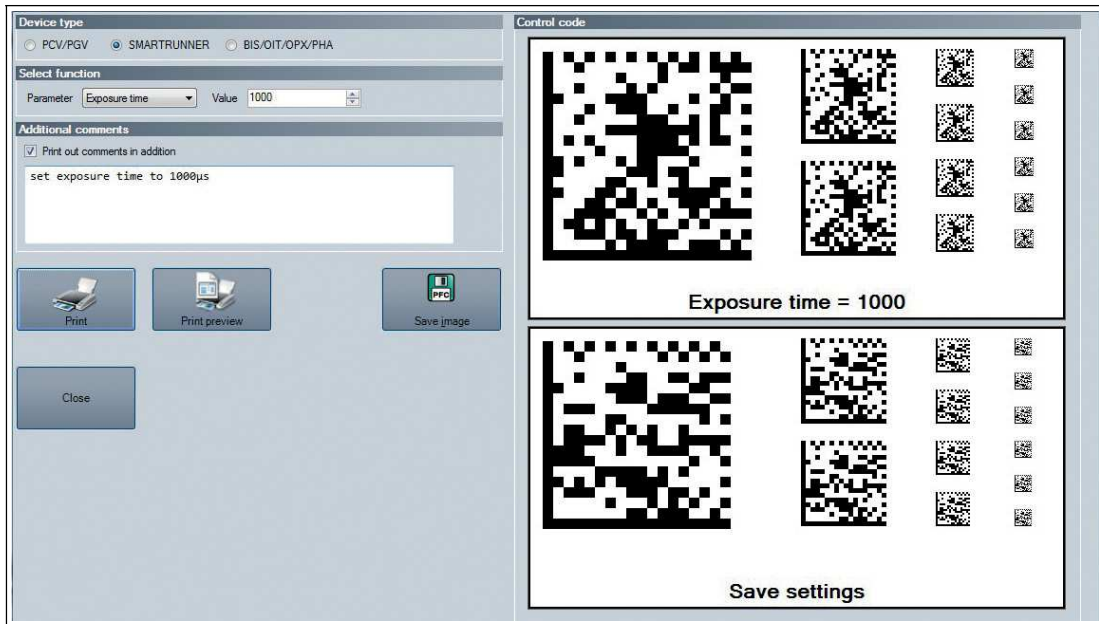

Figure 6.19 Generating a control code: Exposure time of 1000 μ s

6.9 Setting Device Parameters via Control Code

Use Vision Configurator to generate control codes. See chapter 6.8



Note!

Parameterization mode can be activated only within 10 minutes of the sensor being switched on.



Activating Parameterization Mode

Hold down the **2** button on the back of the sensor for more than 2 seconds. Then release the button.

↳ The Ready LED flashes rapidly and the sensor's camera system begins to flash.



Setting Parameters

1. To assign a parameter, position the relevant control code in the sensor's field of view.

↳ If a valid code is detected, the Result LED lights up green briefly
If an invalid code is detected, the Result LED lights up red briefly

2. The modified parameter is now saved in the sensor's volatile memory. The "Save settings" control code then saves the parameter in the non-volatile memory if necessary.



Deactivating Parameterization Mode

Press the **2** button on the back of the sensor.

↳ The Ready LED stops flashing and the camera system stops flashing.

7 Maintenance

To get the best possible performance out of your device, keep the optical unit on the device clean and clean it when necessary.

Observe the following instructions when cleaning:

- Do not touch the optical unit with your fingers.
- Do not immerse the device in water. Do not spray the device with water or other fluids.
- Do not use a scouring agent to clean the surface of the device.
- Use a cotton or paper cloth moistened with water or isopropyl alcohol (not soaked).
- Remove any residual alcohol using a cotton or paper cloth moistened with distilled water (not soaked).
- Wipe the device surfaces dry using a lint-free cloth.

FACTORY AUTOMATION – SENSING YOUR NEEDS



Worldwide Headquarters

Pepperl+Fuchs GmbH
68307 Mannheim · Germany
Tel. +49 621 776-0
E-mail: info@de.pepperl-fuchs.com

USA Headquarters

Pepperl+Fuchs Inc.
Twinsburg, Ohio 44087 · USA
Tel. +1 330 4253555
E-mail: sales@us.pepperl-fuchs.com

Asia Pacific Headquarters

Pepperl+Fuchs Pte Ltd.
Company Registration No. 199003130E
Singapore 139942
Tel. +65 67799091
E-mail: sales@sg.pepperl-fuchs.com

www.pepperl-fuchs.com

 **PEPPERL+FUCHS**
SENSING YOUR NEEDS

Subject to modifications
Copyright PEPPERL+FUCHS • Printed in Germany

/ DOCT-5293A
04/2017