

VisuNet Display Unit DPU1100-* and DPU1200-*

Manual

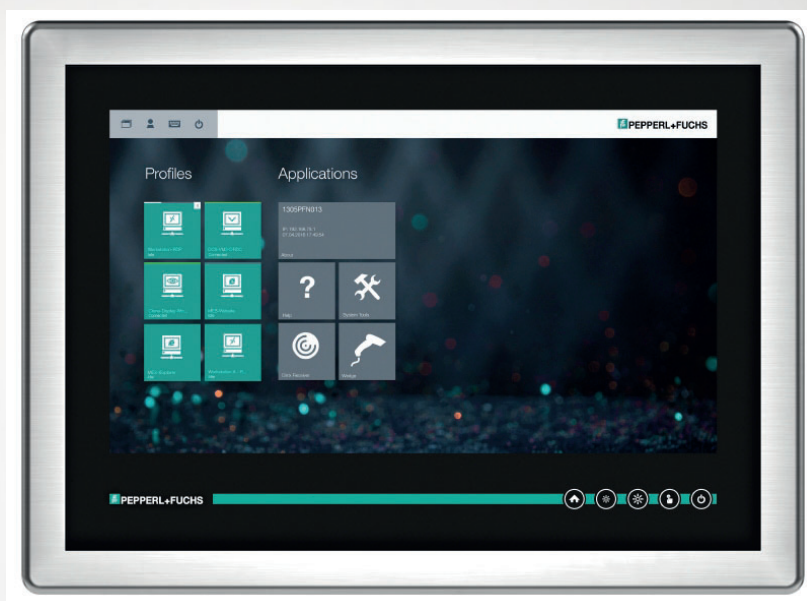

Your automation, our passion.

 **PEPPERL+FUCHS**

With regard to the supply of products, the current issue of the following document is applicable:
The General Terms of Delivery for Products and Services of the Electrical Industry, published
by the Central Association of the Electrical Industry (Zentralverband Elektrotechnik und Elek-
troindustrie (ZVEI) e.V.) in its most recent version as well as the supplementary clause:
"Expanded reservation of proprietorship"

Worldwide

Pepperl+Fuchs Group
Lilienthalstr. 200
68307 Mannheim
Germany
Phone: +49 621 776 - 0
E-mail: info@de.pepperl-fuchs.com

North American Headquarters

Pepperl+Fuchs Inc.
1600 Enterprise Parkway
Twinsburg, Ohio 44087
USA
Phone: +1 330 425-3555
E-mail: sales@us.pepperl-fuchs.com

Asia Headquarters

Pepperl+Fuchs Pte. Ltd.
P+F Building
18 Ayer Rajah Crescent
Singapore 139942
Phone: +65 6779-9091
E-mail: sales@sg.pepperl-fuchs.com
<https://www.pepperl-fuchs.com>

- 1 Introduction..... 4**
 - 1.1 Content of this Document..... 4**
 - 1.2 Target Group, Personnel 4**
 - 1.3 Symbols Used 5**

- 2 Product Description 6**
 - 2.1 Overview 6**
 - 2.2 Technical Data 21.5-Inch Model 8**
 - 2.3 Technical Data 19-Inch Model..... 10**
 - 2.4 Marking 12**
 - 2.5 Dimensions and Type Labels..... 14**

- 3 Installation..... 17**
 - 3.1 Special Conditions of Use 17**
 - 3.2 General Installation Requirements 17**
 - 3.3 Mechanical Installation 18**
 - 3.4 Repair..... 19**

- 4 Operation and configuration 20**

- 5 Bluetooth Interface 26**

- 6 Appendix 27**
 - 6.1 Support Pixel Errors 27**
 - 6.2 Health Monitoring 27**
 - 6.3 Gloves Tested for Touch Sensitivity 29**
 - 6.4 Chemical Resistance of Sealant and Gasket..... 30**

1 Introduction

1.1 Content of this Document

This document contains information that you need in order to use your product throughout the applicable stages of the product life cycle. These can include the following:

- Product identification
- Delivery, transport, and storage
- Mounting and installation
- Commissioning and operation
- Maintenance and repair
- Troubleshooting
- Dismounting
- Disposal



Note

This document does not substitute the instruction manual.



Note

For full information on the product, refer to the instruction manual and further documentation on the Internet at www.pepperl-fuchs.com.



Note

For specific device information such as the year of construction, scan the QR code on the device. As an alternative, enter the serial number in the serial number search at www.pepperl-fuchs.com.

The documentation consists of the following parts:

- Present document
- Instruction manual
- Datasheet

Additionally, the following parts may belong to the documentation, if applicable:

- EU-type examination certificate
- EU declaration of conformity
- Attestation of conformity
- Certificates
- Control drawings
- Functional safety manual
- Additional documents

1.2 Target Group, Personnel

Responsibility for planning, assembly, commissioning, operation, maintenance, and dismantling lies with the plant operator.

Only appropriately trained and qualified personnel may carry out mounting, installation, commissioning, operation, maintenance, and dismantling of the product. The personnel must have read and understood the instruction manual and the further documentation.

Prior to using the product make yourself familiar with it. Read the document carefully.

1.3 Symbols Used

This document contains symbols for the identification of warning messages and of informative messages.

Warning Messages

You will find warning messages, whenever dangers may arise from your actions. It is mandatory that you observe these warning messages for your personal safety and in order to avoid property damage.

Depending on the risk level, the warning messages are displayed in descending order as follows:



Danger!

This symbol indicates an imminent danger.

Non-observance will result in personal injury or death.



Warning!

This symbol indicates a possible fault or danger.

Non-observance may cause personal injury or serious property damage.



Caution!

This symbol indicates a possible fault.

Non-observance could interrupt the device and any connected systems and plants, or result in their complete failure.

Informative Symbols



Note

This symbol brings important information to your attention.



Action

1. This symbol indicates a paragraph with instructions. You are prompted to perform an action or a sequence of actions.

2 Product Description

2.1 Overview

The display units are one of the three core devices of the VisuNet GXP systems 19" or 22" which can be exchanged by the customer. The display units DPU1100-* and DPU1200-* are display panels with optional 10-finger multi-touch-sensors. Displays and touch-sensors are optically bonded with the hardened front glass.



Figure 2.1

The DPU1100-* and DPU1200-* display units are ATEX/IECEX certified, UL listed devices intended for use in potentially explosive atmospheres, such as Zones 1/21 and 2/22 and Class I/II, Div. 2, and Class III.

Connected to a Pepperl+Fuchs thin client or PC unit, the DPU serves as a display with an optional touch screen. It enables users to perceive the system outputs of the computing unit and to input user data.

Five system keys located on the front of the unit allow users to control system functions of the display unit (e.g., brightness control) and the computing unit (e.g., home key). Integrated signal lights on the front keys show selected failure modes in case of a defective component.

The display unit is optimized for use with the modular HMI components of the VisuNet GXP product line: thin client unit (TCU1100-*/TCU1200-*), PC Unit (PCU1100-*/PCU1200-*), and power supply unit (PSU1100-*/PSU1200-*).



Figure 2.2

2.2 Technical Data 21.5-Inch Model

Supply	
Power dissipation	27 W
Power consumption	average: 22 W at maximum brightness: max. 27 W

Display	
Type	LC display with LED backlight Optically bonded
Screen diagonal	54.61 cm (21.5 inches)
Resolution	1920 x 1080 (Full HD), Aspect ratio 16:9
Color depth	16.7 Mio.
Contrast	5000 (typical)
Brightness	300 cd/m ²
Reading angle	175° in all directions
Life span	back lamp life: 50.000-hrs typical half life, at 20°C (68°F)

Input devices	
Touchscreen	Optional: projective capacitive, 10 finger multi-touch, glove-friendly
Control elements	5 capacitive front keys (behind glass): 1 home button, 2 brightness control buttons, 1 touchscreen button, 1 power button

Interface	
Interface type	Interface v1.0 from Pepperl+Fuchs for computing units from Pepperl+Fuchs Bluetooth® v4.0, communication distance up to 30 m in open terrain

Ambient conditions	
Operating temperature	0 ... 50 °C (32 ... 122 °F) (normal operation) -20 ... 50 °C (-4 ... 122 °F) (after 1 hour of operation)
Storage temperature	-20 ... 60 °C (-4 ... 140 °F)
Relative humidity	93% at 40°C, non-condensating, according to EN 60068-2-78
Shock resistance	18 shocks 15 g, 11 ms all axis, IEC 60068-2-27
Vibration resistance	10 ... 150 Hz, +/- 0.075 mm, 1g, 10 cycles per axis according to EN60068-2-6

2023-08

Mechanical specifications	
Degree of protection	IP66 (when mounted on the TCU or PCU unit from Pepperl+Fuchs)

Material	
Surface	Front: glass (optional with stainless steel bezel) Back: Powder-coated aluminum
Mass	approx. 15 kg (DPU1100-*) approx. 11 kg (DPU1200-*)
Dimensions	624 mm x 458 mm x 35 mm
Cut out dimensions	583 mm x 417 mm

2.3 Technical Data 19-Inch Model

Supply	
Power dissipation	25 W
Power consumption	average: 22 W at maximum brightness: max. 25 W

Display	
Type	LC display with LED backlights, optically bonded
Screen diagonal	48.26 cm (19 inches)
Resolution	1280 x 1024 (SXGA), Aspect ratio 5:4
Color depth	16.7 Mio
Contrast	1000:1 (typical)
Brightness	450 cd/m ²
Reading angle	170° horizontal, 160° vertical
Life span	back lamp life: 50.000-hrs typical half life, at 25°C (77°F)

Input devices	
Touchscreen	optional: projective capacitive, 10 finger multi-touch, glove-friendly
Control elements	5 capacitive front keys (behind glass): 1 home button, 2 brightness control buttons, 1 touchscreen button, 1 power button

Interface	
Interface type	Interface v1.0 from Pepperl+Fuchs for computing units from Pepperl+Fuchs Bluetooth® v4.0, communication distance up to 30 m in open terrain



Ambient conditions	
Operating temperature	-20 ... 50 °C (-4 ... 122 °F)
Storage temperature	-20 ... 60 °C (-4 ... 140 °F)
Relative humidity	93% at 40°C, non-condensating, according to EN 60068-2-78
Shock resistance	18 shocks 15 g, 11 ms all axis, IEC 60068-2-27
Vibration resistance	10 ... 150 Hz, +/- 0.075 mm, 1g, 10 cycles per axis according to EN60068-2-6



Mechanical specifications	
Degree of protection	IP66 (when mounted on the TCU or PCU from Pepperl+Fuchs)

Material	
Surface	front: glass (optional with stainless steel bezel) back: Powder-coated aluminum
Mass	approx. 14.5 kg (DPU1100-*) approx. 11 kg (DPU1200-*)
Dimensions	524 mm x 453 mm x 35 mm
Cut out dimensions	499 mm x 419 mm



2.4 Marking

ATEX / IECEx / UKEx Marking

Display Unit DPU1100-J1-*
Pepperl+Fuchs Group Lilienthalstraße 200, 68307 Mannheim, Germany
ATEX:  II 2G Ex eb q ib IIC T4 IP66 Gb  II 2D Ex tb IIIC T80 °C Db
IECEx: IECEx BVS 16.0061X
UKEx: CML 21UKEX3470X  II 2 G D Ex eb q ib IIC T4 Gb Ex tb IIIC T80°C Db IP66

Display Unit DPU1200-J2-*
Pepperl+Fuchs Group Lilienthalstraße 200, 68307 Mannheim, Germany
ATEX:  II 2G Ex eb q ib IIC T4 IP66 Gb  II 2D Ex tb IIIC T80 °C Db
IECEx: Ex ec IIC T4 Gc Ex tc IIIC T80 °C Dc

UL Marking

 PEPPERL+FUCHS 68307 Mannheim, Germany www.pepperl-fuchs.com		
 Ind. Cont. Eq. for Haz. Loc. E492874	Class I, Division 2, Groups A, B, C, D; T4 Class II, Division 2, Groups F, G; T4 Class III -20°C ≤ Ta ≤ +50°C No user serviceable parts inside this enclosure. Aucune pièce réparable par l'utilisateur.	
		Class I Zone 2, Group IIC; T4 Class II Zone 22, Group IIIB; T85°C Class III Zone 22, Group IIIA; T85°C -20°C ≤ Ta ≤ +50°C

Note

FCC Digital Devices Statement for All DPU Models

This equipment has been tested and found to comply with the limits for a Class A digital device, pursuant to part 15 of the FCC Rules. These limits are designed to provide reasonable protection against harmful interference when the equipment is operated in a commercial environment. This equipment generates, uses, and can radiate radio frequency energy and, if not installed and used in accordance with the instruction manual, may cause harmful interference, in which case the user will be required to correct the interference at his own expense.





Note

Additional Information for Models with Bluetooth® Option

Contains FCC ID: SQG-BT800

Contains IC ID: 3147A-BT800

Device complies with CAN ICES-3(A)/NMB-3(A)

2.5 Dimensions and Type Labels

Dimensions 21.5-Inch Model

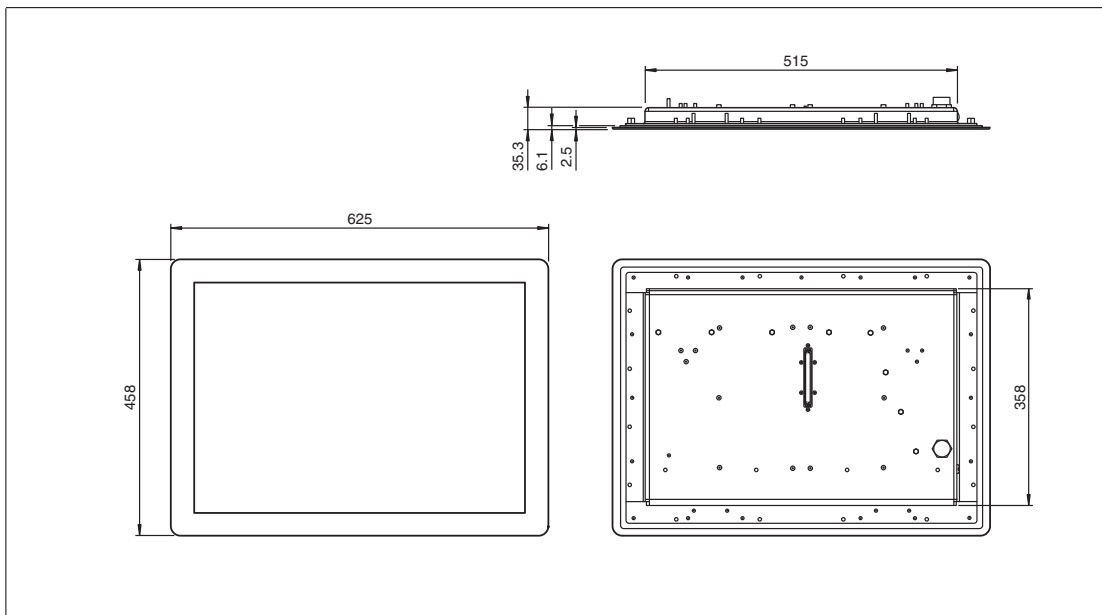

Figure 2.3 Dimensions with bezel 21.5 inch

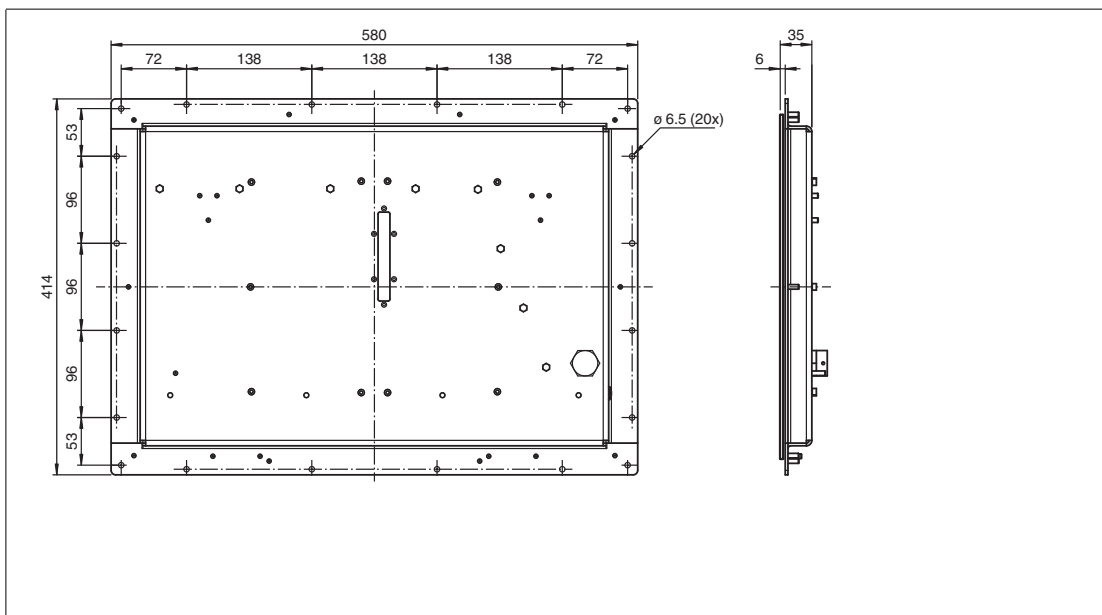

Figure 2.4 Hole pattern 21.5 inch



Note

The VisuNet GXP DPUs can be mounted within the AG-XX00 housing as well as panel mounted or flush mounted. For further information regarding the installation and mounting, refer to VisuNet GXP 22" system manual.

Dimensions 19-Inch Model

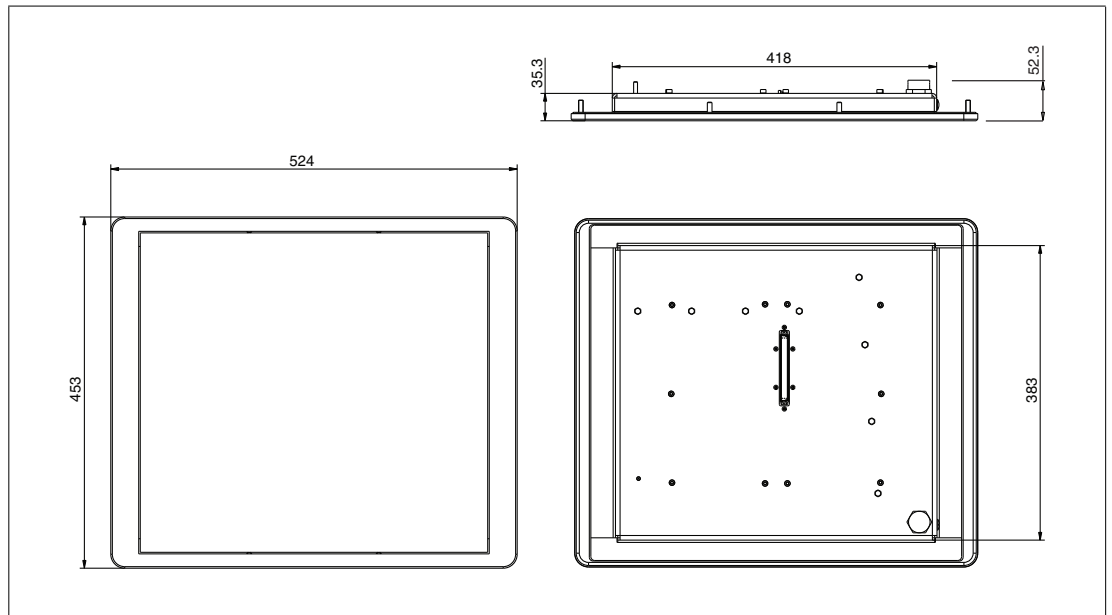

Figure 2.5 Dimensions with bezel 19 inch

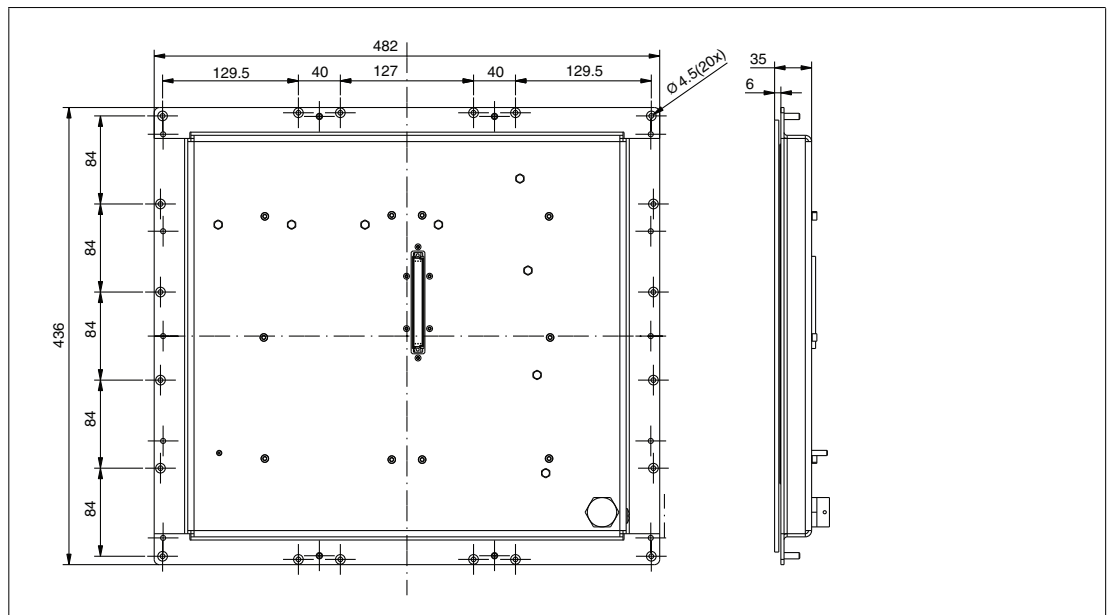

Figure 2.6 Hole pattern 19 inch





Note

The VisuNet GXP DPUs can be mounted within the AG1 housing as well as panel mounted or flush mounted. For further information regarding the installation and mounting, refer to VisuNet GXP 19" system manual.

Labels

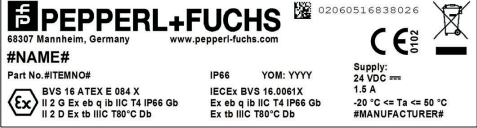
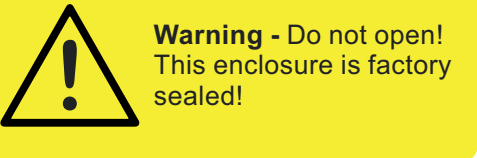
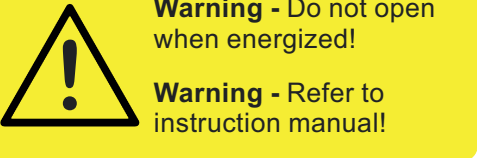
The following labels are present on the display unit.

<p>Type label display unit</p>	
<p>optional: GXP type label</p>	<p>optional, in case of a GXP panel, otherwise mounted on GXP enclosure</p>
<p>Warning marking "Warning – Do not open! This enclosure is factory sealed." "Avertissement – Cette enveloppe est scellée en usine. Ne pas l'ouvrir!"</p>	
<p>Warning marking "Warning – Do not open when energized!" "Warning – Refer to instruction manual!" "Avertissement – Ne pas ouvrir sous tension!" "Avertissement – Reportez-vous au manuel d'instruction!"</p>	
<p>Warning marking "Warning - Potential Electrostatic Charging Hazard - See Instructions"</p>	

3 Installation



Note

For detailed installation information, see the VisuNet GXP system manual.



Caution!

Device damage!

Mount the device in such a way that it is protected from ultraviolet radiation and sunlight. Do not expose the device to direct sunlight! The device might get damaged.



Caution!

Device damage!

Protect the device from external heat sources (e.g. sunlight).



Caution!

Use of the device!

The use of the device is only permitted under the ambient conditions (temperature, humidity, vibration and shock) which are specified in the technical data. Failure to comply with any of these conditions void the warranty for the device. Pepperl+Fuchs cannot be held liable for any damage arising from improper use and handling.

3.1 Special Conditions of Use

- The DPU must be mated with a suitably certified module, such as a TCU or PCU. (DPU1100 with TCU1100/ PCU1100 and DPU1200 with TCU1200/ PCU1200)
- Connection of DPU and TCU/PCU shall only be made when de-energized.
- The danger of ignition due to electrostatic discharges must be avoided by mounting the apparatus in areas without electrostatic charging mechanism. See IEC 60079-32-1 for further information.
- In hazardous dust environments, regularly remove dust from the display unit to prevent excessive temperature rise. Use a clean damp cloth.
- The device shall be installed such that risk of high-impact energy on display glass is considered to be low.
- Mount the device in such a way that it is protected from ultraviolet radiation and from direct sunlight.

3.2 General Installation Requirements

Observe the following requirements when installing the display unit.

- The equipment must be installed by competent personnel in accordance with the instructions. National laws and regulations must be observed.
- The building installation must provide a 20 A overcurrent protection.
- The installer must make a readily accessible disconnect device available.
- The safety of any system incorporating the power supply unit is the responsibility of the assembler of the system.
- Power supplied from the TCU**00-* or PCU**00-* needs to be from a SELV or PELV source.

3.3 Mechanical Installation



Note

For system installation instructions and complete mounting options, see the VisuNet GXP System Manual.



Mounting the PCU/TCU onto the DPU

1. Ensure the correct position of the PCU/TCU.
2. Place the PCU/TCU with the Pepperl+Fuchs connector above the Pepperl+Fuchs socket on the back of the display unit.

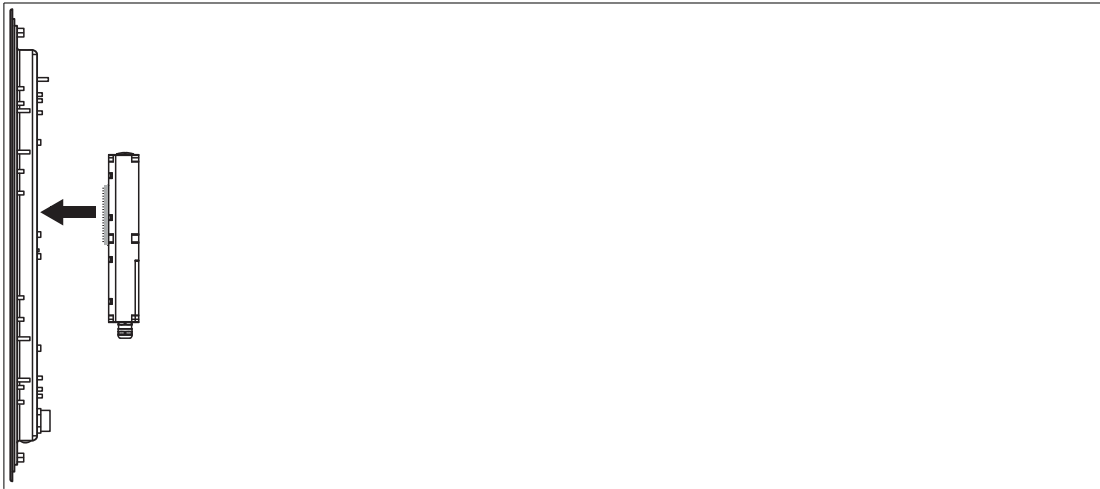

3. Carefully push the Pepperl+Fuchs connector into the Pepperl+Fuchs socket.
4. Use the mounting screws to attach the PCU/TCU onto the display unit (tightening torque 3 Nm).

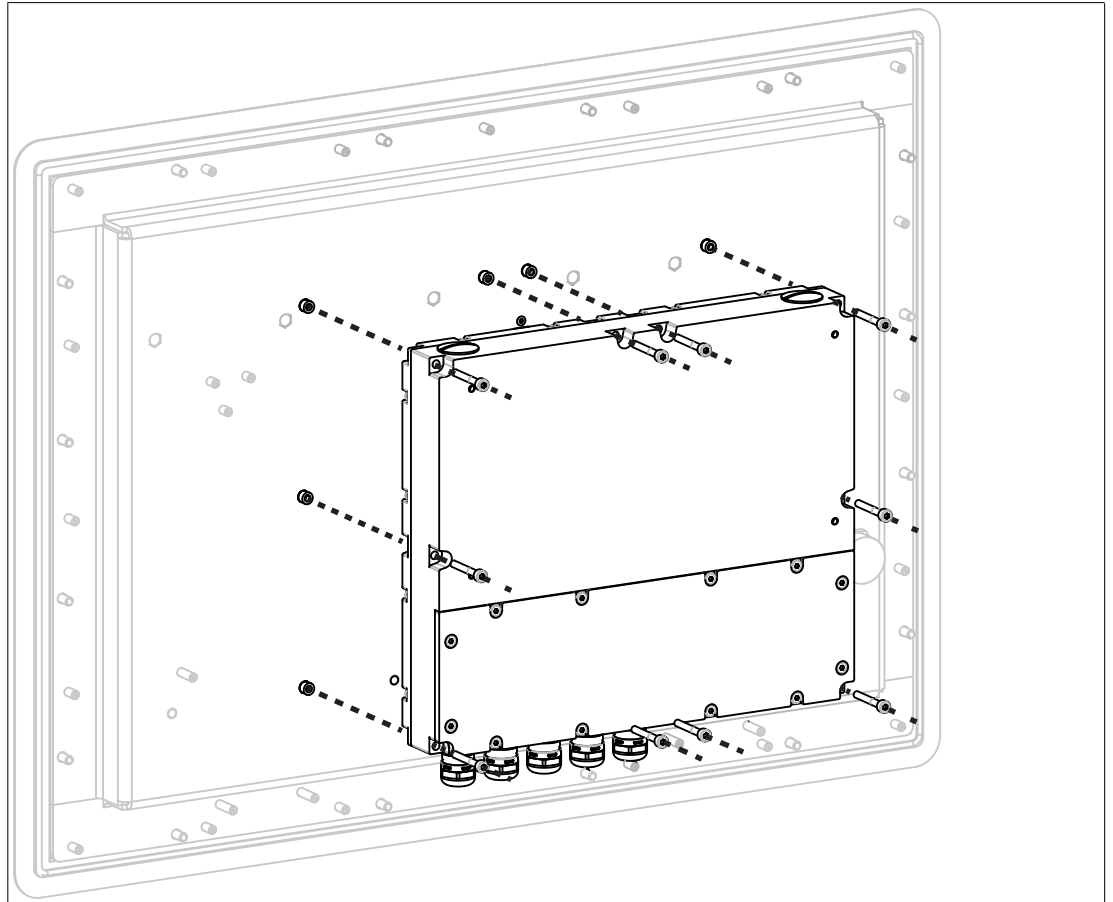

Figure 3.1 Mounting the TCU/PCU onto the display unit



Caution!

Damage to pins

Carefully align the PCU/TCU with the DPU when connecting the units. Mounting or dismantling the PCU/TCU at an angle can damage the pins.

3.4

Repair



Note

The DPU can be dismantled from the PCU/TCU and sent to Pepperl+Fuchs for repair and/or replacement. For mounting and dismantling instructions, see the VisuNet GXP system manual.

4 Operation and configuration

Front buttons

The DPU1100-*/DPU1200-* provides several system functions via the capacitive front buttons. The front buttons are embedded in the system and located behind the security glass.



Warning!

Warning!

Do not use sharp tools like screwdrivers to trigger the front buttons.



Warning!

Warning!

Do not use the display when there are scratches in the front glass.

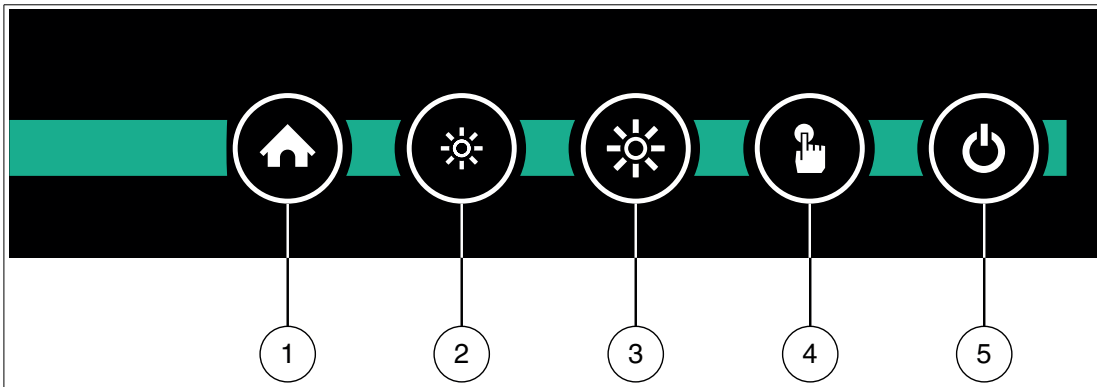







Figure 4.1 Buttons on the display front

	Button	Description
1	Home	Configurable front button to call a specified function
2	Brightness -	Reduce display brightness (dimable to 0 %)
3	Brightness +	Increase display brightness
4	Touch screen	Enable/disable touch screen (e.g. for cleaning purposes). If the display unit has no built-in touch screen, the touch screen button is disabled.
5	Power	Configurable power button (shutdown, restart, hibernate); button can be disabled

Status OFF - Power OFF	off	off	off	off	off
Status OFF - Power ON	off	off	off	off	on (solid white)
Power ON - Touch screen ON	on (solid white)	on (solid white)	on (solid white)	on (solid white)	on (solid green)
Power ON - Touch screen OFF	on (solid white)	on (solid white)	on (solid white)	on (flashing white)	on (solid green)

2023-08

					
Power ON - Display OFF (brightness 0 %)	on (solid white)	on (solid white)	on (flashing white)	on (solid white)	on (solid green)
Sleeping mode	off	off	off	off	on (flashing green)

Status OFF - Power OFF

LEDs off

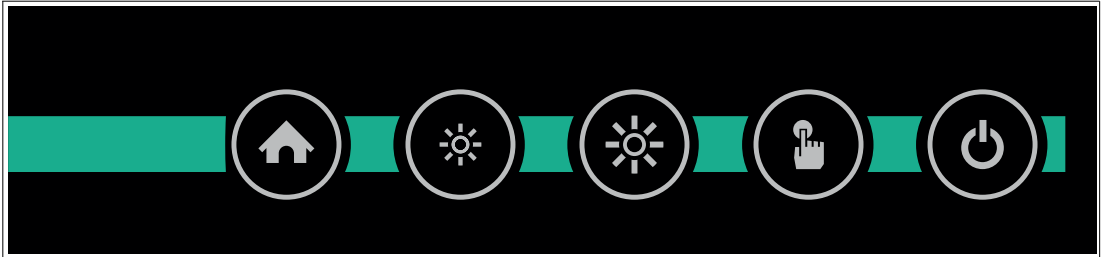

Status OFF - Power ON

Power LED solid white

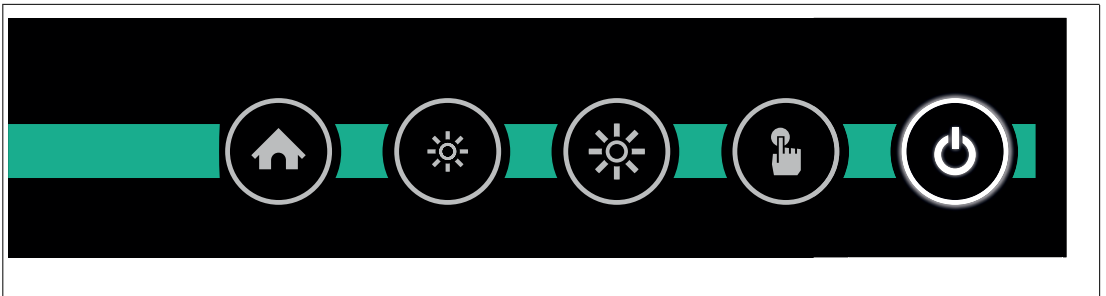

Power ON - Touch screen ON

- Power LED solid green
- Other LEDs solid white

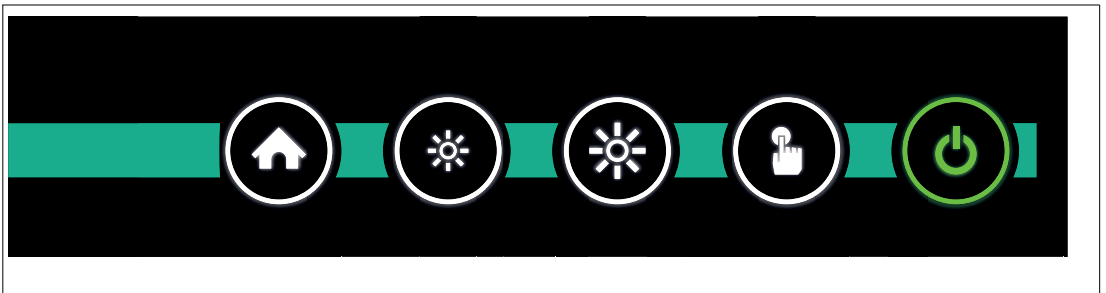

Power ON - Touch screen OFF

- Power LED solid green
- Touch screen LED flashing white
- Other LEDs solid white

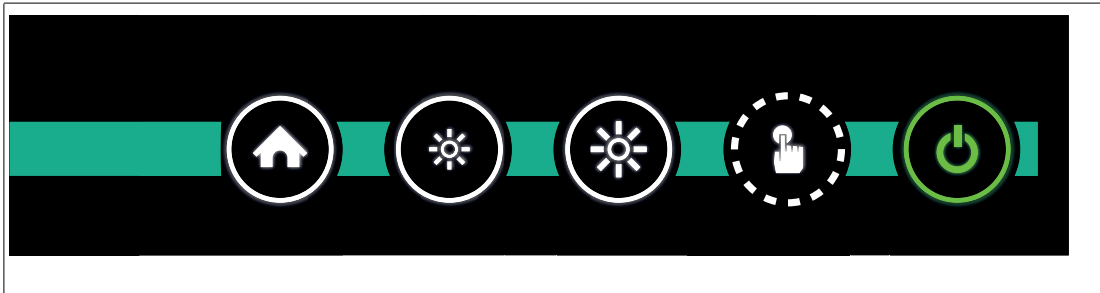

Power ON - Display OFF (brightness 0 %)

- Power LED solid green
- "Brightness +" LED flashing white
- Other LEDs solid white

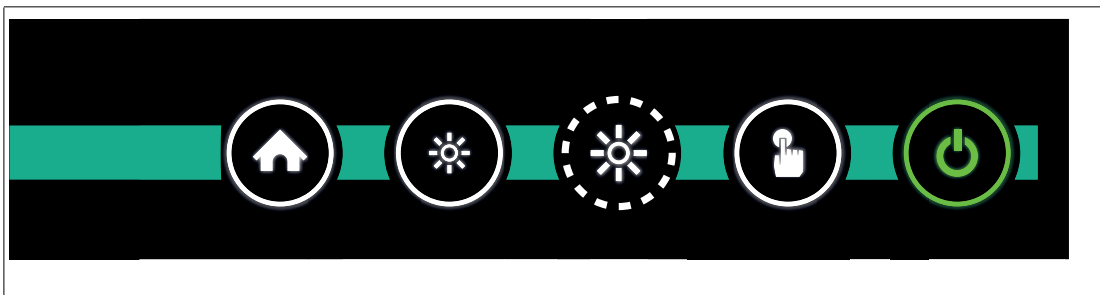

Sleeping

- Power LED flashing green
- Other LEDs off

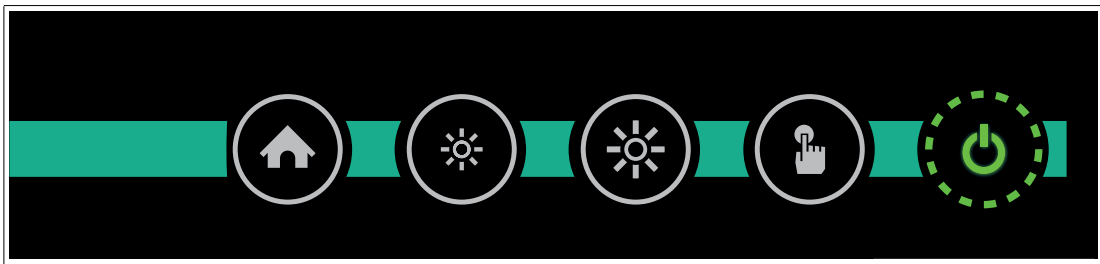



Brightness control

The service controller sets the backlight brightness and controls it directly with the two brightness buttons.



Increasing / Reducing brightness

1. To increase the display brightness, press the  button. Press and hold the button to increase the display brightness faster.
↳ Each single button press increases the display brightness about 10 %. Pressing and holding the button increases the brightness about 20 % every 0.5 second.
2. To reduce the display brightness, press the  button. Press and hold the button to reduce the display brightness faster.
↳ Each single button press reduces the display brightness about 10 %. Pressing and holding the button reduces the brightness about 20 % every 0.5 second.



Rebooting the system

1. To reboot the system, press and hold ,  and  for 5 seconds.

Touch screen

In contrast to resistive touch screens, the 10-point multi-touch capacitive touch screen behind security glass does not operate with selective force.

The functional principle is based on the change of a capacitive field: a small electric current runs across the touch screen and is measured in the corners of the touch screen. Touching the display with a finger or a suitable stylus will change the capacitance of the electrical field. In this way the exact finger/stylus position can be located on the touch screen.



Note

Pepperl+Fuchs' capacitive touch screens have been tested for use with gloves. For a list of tested gloves, see chapter 6.3.

Touch Sensitivity

To increase or decrease the sensitivity of the touch screen, several different sensitivity profiles are available.

This allows adjusting the sensitivity of the touch sensor according to the application requirements (e.g. for working with gloves).



Increasing / Decreasing touch sensitivity by choosing a sensitivity profile

1. To choose a sensitivity profile, use the VisuNet RM Shell user interface.



(Re-)calibrating the touch screen

1. To (re-)calibrate the touch screen use the VisuNet RM Shell user interface.

Locking / Unlocking front buttons

The capacitive front buttons are sensitive to water and moisture. To avoid "false positive" button triggers in challenging environments, the front buttons can be protected with a lock mechanism in Service Controller firmware versions 1.3.2.198 and higher.

The lock mechanism can only be enabled via VisuNet RM Shell 5 firmware. This feature is available in VisuNet RM Shell 5 versions with an update of 5.0.1.441 or higher.

The default setting of the button lock mechanism is "off."



Locking the front buttons via VisuNet RM Shell 5

1. From the main screen of RM Shell 5, change "Operator" to "Administrator."
2. Enter the system settings app by clicking the appropriate icon on the home screen.
3. Navigate to "front key settings" on the navigation bar.
4. Enable the keypad lock mechanism.
5. Set the idle time before the automatic locking of the keypad (in seconds) by using the slider to adjust between 1 second ... 120 seconds.
 - ↳ The keypad lock mechanism is activated.
 - ↳ By pressing any button except the home button, the unlock animation is shown.
 - ↳ After the set idle time, the front buttons will be locked automatically. To signal this, all LEDs flash 3 times.
6. To lock the front buttons before the idle time has passed, press and hold the  button until all LEDs are flashing 3 times.

The locking feature can also be set on startup, or only single buttons can be disabled as requested. For more information, refer to the latest version of the VisuNet RM Shell 5 manual at www.pepperl-fuchs.com.



Apply / Revert changes in VisuNet RM Shell 5



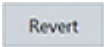

If you changed settings, the "Apply Changes" button turns green to indicate changes to the current settings.

1. To save the changes, press .
 - ↳ The changes have been saved.
2. If you want to discard the changes, press .
 - ↳ The changes have been discarded. The settings have been set back to the last saved version.



Unlocking the front buttons via VisuNet RM Shell 5

In the enabled keypad lock mechanism, none of the front buttons operates individually, but the front buttons continue to show the same state as unlocked. The attempt to press a key causes all LEDs to flash 3 times. The front buttons must be unlocked before the button functions can be used. To unlock the front buttons, an unlock sequence from left to right on the keypad is required.

1. Press the  button when it is illuminated.
2. Press the  button when it is illuminated.
3. Press the  button when it is illuminated.
4. Press the  button when it is illuminated.
5. Press the  button when it is illuminated.

↳ If the unlock sequence is performed incorrectly, the process must be started again from the beginning. An unsuccessful unlocking sequence is indicated by an animation: all buttons flash twice, followed by the animation that shows the unlock sequence via the front button LEDs.

If the keypad lock mechanism is activated and any button is pressed except the home button, the unlock animation is shown. After the set idle time, the front buttons will be locked again automatically. To signal this, all LEDs flash three times. To lock the front buttons before the idle time has passed, press and hold the "touch enable/disable" button until all LEDs are flashing three times. The locking feature can also be set on startup, or only single buttons can be disabled as requested. For more information, refer to the latest version of the VisuNet RM Shell 5 manual on www.pepperl-fuchs.com.

5 Bluetooth Interface

Pepperl+Fuchs' DPU1100/DPU1200 series display units are available with an optional Bluetooth® interface. This enables Bluetooth devices (i.e., an Ident-Ex® 01 handheld scanner) to be used with VisuNet HMI systems.

For the Bluetooth interface to work properly, you must disable a Windows® setting that allows the computer to automatically turn off Bluetooth.

Perform the following steps to disable the Bluetooth power management setting:



Disabling Bluetooth® Power Management Setting

1. Navigate to the "Hardware and Sound" section of the Windows control panel. Select the "Device Manager" under "Devices and Printers."
2. Right click "Generic Bluetooth Radio" under "Bluetooth Radios."

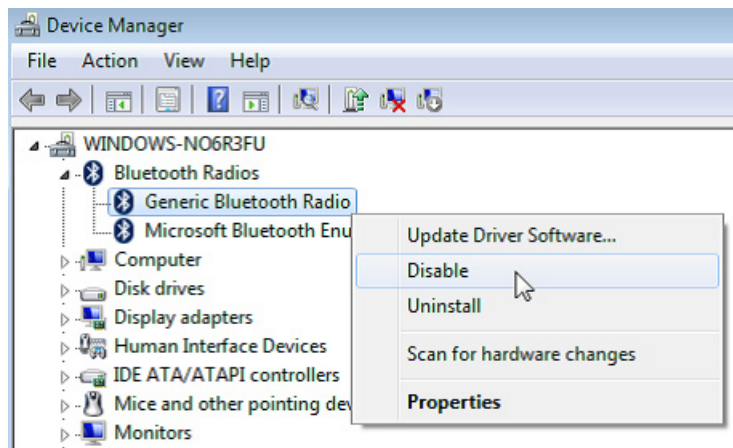

3. Open the "Power Management" tab and deactivate the option "Allow the computer to turn off this device to save power."

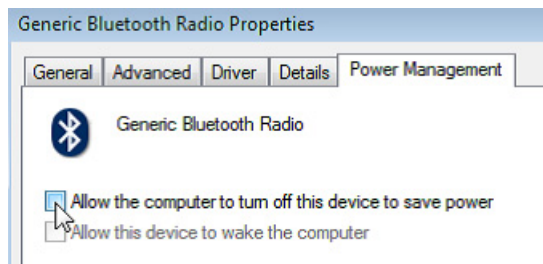

Note

For detailed instructions on connecting Bluetooth devices to VisuNet RMs and thin clients, see the RM Shell 5 manual.



6 Appendix

6.1 Support Pixel Errors

With current LCD technology, a panel may contain a limited number of missing or flickering pixels.

Pepperl+Fuchs display units are tested according to internationally recognized standards in order to fulfill the tolerated pixel errors.

The following pixel errors in the LC display are due to production and do not represent an reason for complaint:

Inspection item	Specification
Line defect	can't be seen
Bright dots	≤ 1 dots (note 1&2)
Dark dots	≤ 5 dots
Total dots defect	≤ 5 dots

Table 6.1

6.2 Health Monitoring

CPU / Display Error

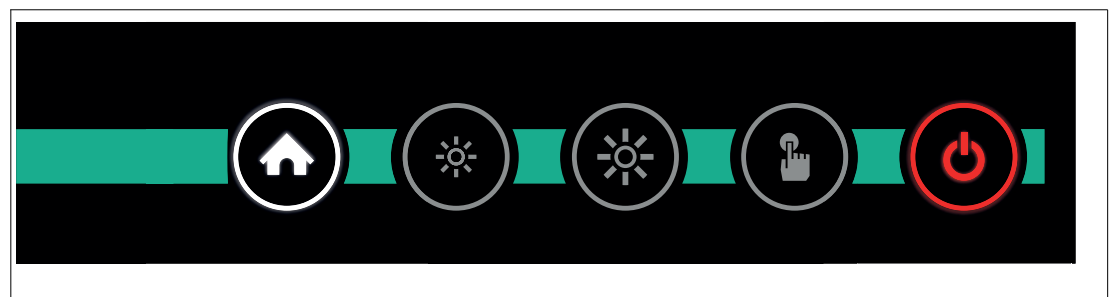

Indication	Problem	Solution
Home button solid white Power button solid red	CPU (Most likely Service Controller) damaged	Replace the CPU
	If backlight still turns on: Display frontkey controller damaged	Replace the display unit

Temperature Error (too Low)

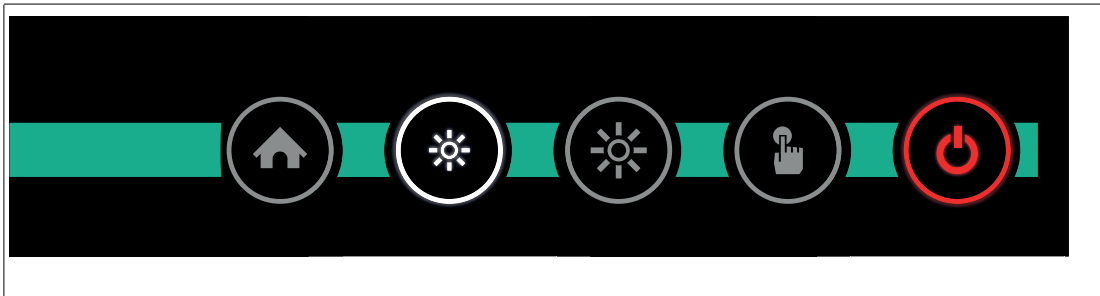

Indication	Problem	Solution
"Brightness -" button solid white Power button solid red	Temperature too low (monitored only during booting up)	Check if ambient temperature surrounding the panel is lower than the panel's allowed operating temperature.

Temperature Error (too High)

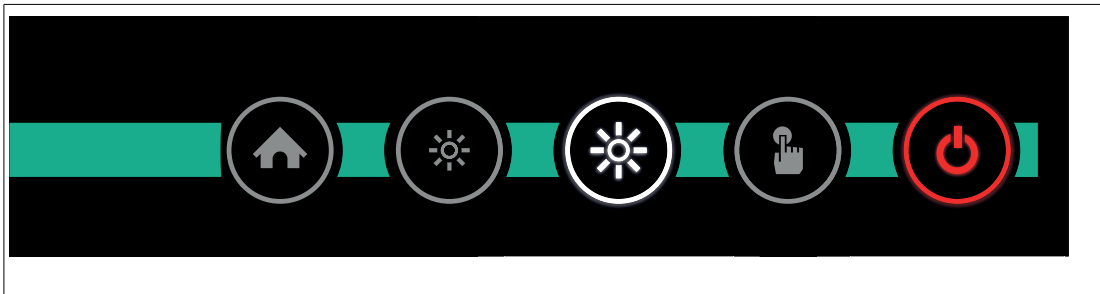

Indication	Problem	Solution
"Brightness +" button solid white Power button solid red	Temperature too high (monitored only during booting up)	Check if ambient temperature surrounding the panel exceeds the panel's allowed operating temperature.

Communication Error

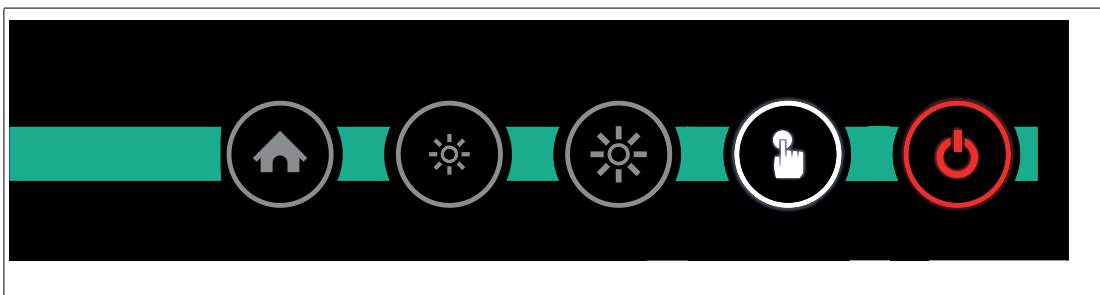

Indication	Problem	Solution
Touchscreen button solid white Power button solid red	No communication with DPU devices (e.g. storage device, temperature monitoring,...)	Replace display unit

6.3 Gloves Tested for Touch Sensitivity

This section lists selected gloves and their touch sensitivity with the capacitive touch screen. This test was conducted by Pepperl+Fuchs.



Warning!

Warning!

It is the end-user's responsibility to choose appropriate gloves. The below list is not exhaustive, and it only deals with touch sensitivity. The ratings do not indicate, for example, whether a glove has chemical resistance.



Note

To improve the touch detection rate with gloves, touch with the flat side of your finger and not with your finger tip.



Note

The sensitivity of a TCU-based system touch screen can be configured in the RM Shell. The sensitivity of a PCU-based system touch screen can be configured with the Windows tool.

Rating Scale

+++	High touch sensitivity, easy to operate the touch screen
++	Some touch sensitivity, possible to operate the touch screen
+	Little touch sensitivity, difficult to operate the touch screen

The following gloves have been tested for use with the display unit:

Nitrile Gloves

	Rating
Nitrile gloves NITRITEC	+++
Cotton gloves and two layers of Nitril gloves NITRITEC	+++

Latex Gloves

	Rating
Marigold Industrial SOLVAPLUS	+++
Marigold Industrial Emperor Mediumweight	+++
Mapa Professionnel Technic 450	++
Disposable gloves SEMPERGUARD	+++
Disposable gloves AccuTech Sterile Coated	+++
Disposable gloves Nutex® DermaShield®	++

Chemical Protection Gloves

	Rating
Chemical protection gloves EKASTU	++

Cotton Gloves

	Rating
UVEX UNIGRIP-CL 6627	++
UVEX UNIDUR 6641	++
UVEX HELIX C3 DRY	+++
Heat-resistant gloves KCL 955 09 Thermoplus	+++

Leather Gloves

	Rating
FUTURO Adler 5	+++
Leather gloves RESISTA	+
Leather gloves Worky Type 1710	+++

6.4 Chemical Resistance of Sealant and Gasket

The display unit consists of a chemically edged front glass and an optional stainless steel bezel. The chemical resistance of the sealant between the glass and bezel was specified by the sealant manufacturer. Pepperl+Fuchs also tested the resistance of the sealant and the resistance of the gasket between the bezel and the housing.

Chemical Resistance of Sealant as Specified by Manufacturer

Chemical	Duration at 23 °C 1 month	Duration at 23 °C 3 months
Washing agent (Vel; Colgate-Palmolive AG)	XX	XX
Ammoniac (salmiac) 5%	XX	X
Car polish ("Riwax C3 Lack-reiniger")	X	X
Bactericidal 5% (Ethoral)	X	X
Leaded gasoline	X	X
Unleaded petrol	X	X
Disinfectant 5% (Betadine)	XX	XX
Diesel	XX	XX
Acetic acid 10%	X	X
Acetic acid 20%	X	X
Glass cleaner ("Wetrol Brilliant; Diethelm AG")	XX	XX
Tung oil	XX	XX
Isopropyl alcohol	X	X
Liquid manure (cows / pigs)	XX	XX
Methyl ethyl ketone (MEK)	0	0
Methyl alcohol	X	X
Lactic acid	X	X
Milk (fermented/sour)	XX	XX
Engine oil ("Shell Protella 20W40")	XX	XX
Caustic soda 5%	XX	XX

2023-08

Chemical	Duration at 23 °C 1 month	Duration at 23 °C 3 months
Sodium chloride 5%	XX	XX
Oxalic acid 5%	X	X
Nitric acid 5%	X	0
Hydrochloric acid 5%	X	X
Sulfuric acid 5%	XX	XX
Teak oil	XX	XX
Carbamide 5%	XX	XX
Washing powder 2% ("Dash 3")	XX	XX
Water	XX	XX
Water (lake of Zürich)	XX	XX
Tartaric acid 5%	XX	XX
Xylene	0	0

Table 6.2 XX=good resistance, X=medium resistance, 0=non or only short-term resistance

Chemical Resistance as Determined by Pepperl+Fuchs

Pepperl+Fuchs tested the chemical resistance of the sealant and gasket to selected chemicals. When submerged in the following chemicals for 48 hours at an ambient temperature of 25 °C, the sealant remained undamaged.

Chemical	Concentration
Methanol	99.8 %
Acetone	99.8 %
Hexane	99.8 %
Toluene	99.8 %
Lösol 80	99.8 %
Hydrogen peroxide	5 %
Hydrogen peroxide	30 %

Your automation, our passion.

Explosion Protection

- Intrinsic Safety Barriers
- Signal Conditioners
- FieldConnex® Fieldbus
- Remote I/O Systems
- Electrical Ex Equipment
- Purge and Pressurization
- Industrial HMI
- Mobile Computing and Communications
- HART Interface Solutions
- Surge Protection
- Wireless Solutions
- Level Measurement

Industrial Sensors

- Proximity Sensors
- Photoelectric Sensors
- Industrial Vision
- Ultrasonic Sensors
- Rotary Encoders
- Positioning Systems
- Inclination and Acceleration Sensors
- Fieldbus Modules
- AS-Interface
- Identification Systems
- Displays and Signal Processing
- Connectivity

Pepperl+Fuchs Quality

Download our latest policy here:

www.pepperl-fuchs.com/quality

