

# MANUAL

## Multi-Input/Output Device

F2D0-MIO-Ex12.PA.\*

R8D0-MIO-Ex12.PA.\*

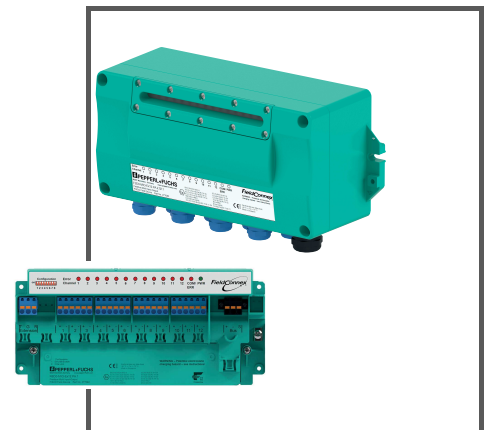

**PROFI<sup>®</sup>**  
**BUS**



With regard to the supply of products, the current issue of the following document is applicable: The General Terms of Delivery for Products and Services of the Electrical Industry, published by the Central Association of the Electrical Industry (Zentralverband Elektrotechnik und Elektroindustrie (ZVEI) e.V.) in its most recent version as well as the supplementary clause: "Expanded reservation of proprietorship"

<b>1</b>	<b>Introduction.....</b>	<b>7</b>
1.1	Content of this Document .....	7
1.2	Target Group, Personnel.....	7
1.3	Symbols Used .....	7
<b>2</b>	<b>Product Specifications.....</b>	<b>9</b>
2.1	Overview and Application .....	9
2.2	Modes of Operation .....	9
2.3	Hazardous Area Installation and Use.....	12
<b>3</b>	<b>Installation and Commissioning .....</b>	<b>14</b>
3.1	Mounting and Dismounting.....	14
3.2	Hardware Installation.....	15
3.2.1	R8D0-MIO* Cable and Connection Information .....	15
3.2.2	F2 Housing Degree of Protection .....	19
3.2.3	Grounding and Shielding .....	21
3.2.4	DIP Switch Settings .....	23
3.3	PROFIBUS Ident Number Setting .....	25
3.4	Requirements for Commissioning.....	26
3.5	Parameterization and Configuration Procedure .....	26
<b>4</b>	<b>Configuration .....</b>	<b>27</b>
4.1	Host System Integration.....	27
4.2	Configuration of Cyclic Communication .....	27
4.3	Cyclic Communication Data Description.....	29
4.3.1	Valve Coupler Mode and FD0-VC Compatibility Mode Variables .....	29
4.3.2	Sensor Input Mode and FD0-BI Compatibility Mode Variables .....	34
4.4	Cyclic Communication Data Structure.....	36
4.4.1	Valve Coupler Mode and FD0-VC-Ex4.PA Compatibility Mode .....	36
4.4.2	Example of a Typical Configuration in Valve Coupler Mode .....	37
4.4.3	Sensor Input Mode and FD0-BI-Ex12.PA Compatibility Mode .....	37
4.4.4	Example of a Typical Configuration in Sensor Input Mode .....	38

<b>5</b>	<b>Parameterization in Cyclic Communication (Set_Prm).....</b>	<b>39</b>
5.1	Condensed Status and Diagnosis.....	39
5.2	FD0-BI-Ex12 Compatibility Mode.....	39
<b>6</b>	<b>Troubleshooting and Diagnosis.....</b>	<b>41</b>
6.1	LED Status and Error Indication.....	41
6.2	Device Internal Errors.....	42
6.3	Diagnosis.....	42
6.4	Initialization Run (Valve Coupler Mode).....	46
<b>7</b>	<b>Device-Related Parameters.....</b>	<b>49</b>
7.1	Device Identification.....	49
7.2	Device Documentation.....	49
<b>8</b>	<b>Channel-Related Parameters for the Valve Coupler Modes .</b>	<b>50</b>
8.1	Use of Setpoint Variables SP_D and RIN_D.....	50
8.2	Modes of Operation.....	51
8.2.1	Device Maintenance Modes.....	51
8.2.2	Operating Modes.....	51
8.2.3	Operating Mode "Auto" in Case of Fault.....	51
8.2.4	Operating Mode "Remote-Cascade (RCas)".....	52
8.3	Functional Parameters.....	52
8.3.1	Actuator Fail Action.....	52
8.3.2	Sensor Usage.....	53
8.4	Diagnostic Parameters.....	54
8.4.1	Wire Check.....	54
8.4.2	Stroke Counter.....	54
8.4.3	Time Monitoring.....	54
8.4.4	Cyclic Function Test (Partial Stroke Test).....	56

<b>9</b>	<b>Channel-Related Parameters for the Sensor Input Modes ...</b>	<b>57</b>
<b>9.1</b>	<b>Modes of Operation .....</b>	<b>51</b>
<b>9.1.1</b>	Device Maintenance Modes .....	57
<b>9.1.2</b>	Operating Modes .....	57
<b>9.1.3</b>	Operating Mode "Auto" in Case of Fault.....	57
<b>9.2</b>	<b>Functional Parameters.....</b>	<b>52</b>
<b>9.2.1</b>	Sensor Mode .....	57
<b>9.2.2</b>	Sensor-On Time .....	58
<b>9.3</b>	<b>Diagnostic Parameters .....</b>	<b>54</b>
<b>9.3.1</b>	Sensor Wire Check.....	58
<b>10</b>	<b>PACTware Multi-Input/Output Device Type Manager .....</b>	<b>59</b>
<b>10.1</b>	<b>DTM Software Installation and Commissioning.....</b>	<b>59</b>
<b>10.2</b>	<b>Device Type Manager (DTM) Dialogs .....</b>	<b>60</b>
<b>10.2.1</b>	Online Dialogs .....	61
<b>10.2.2</b>	Offline Dialogs .....	62
<b>10.2.3</b>	Multi-Input/Output Device Type Manager User Interface.....	63
<b>10.2.4</b>	MIO DTM for Sensor Input Mode - Structural Diagram.....	64
<b>10.2.5</b>	MIO DTM for Valve Coupler Mode - Structural Diagram.....	67
<b>10.3</b>	<b>Basic Device Setup in Sensor Input Mode .....</b>	<b>69</b>
<b>10.3.1</b>	Tab "Device Information" .....	74
<b>10.3.2</b>	Device Tab "Diagnostics" .....	75
<b>10.3.3</b>	Sensor Input Channels 1 ... 12.....	77
<b>10.3.4</b>	Tab "General" .....	78
<b>10.3.5</b>	Tab "Process Data" for a Binary Input.....	79
<b>10.3.6</b>	Tab "Process Data" for a Frequency Input.....	81
<b>10.3.7</b>	Tab "Process Data" for a Counter.....	83
<b>10.3.8</b>	Tab "Configuration" .....	84
<b>10.3.9</b>	Channel Tab "Diagnostics".....	86



<b>10.4</b>	<b>Basic Device Setup in Valve Coupler Mode .....</b>	<b>88</b>
10.4.1	Tab "Device Information" .....	89
10.4.2	Device Tab "Diagnostics" .....	91
10.4.3	Valve Coupler Connections 1 ... 4 .....	93
10.4.4	Tab "General" .....	93
10.4.5	Tab "Process Data" .....	95
10.4.6	Tab "Configuration" .....	98
10.4.7	Tab "Monitoring" .....	100
10.4.8	Channel Tab "Diagnostics" .....	102

# 1 Introduction

## 1.1 Content of this Document

This document contains information that you need in order to use your product throughout the applicable stages of the product life cycle. These can include the following:

- Product identification
- Delivery, transport, and storage
- Mounting and installation
- Commissioning and operation
- Maintenance and repair
- Troubleshooting
- Dismounting
- Disposal



**Note!**

This document does not substitute the instruction manual.



**Note!**

For full information on the product, refer to the instruction manual and further documentation on the Internet at [www.pepperl-fuchs.com](http://www.pepperl-fuchs.com).

The documentation consists of the following parts:

- Present document
- Instruction manual
- Datasheet

Additionally, the following parts may belong to the documentation, if applicable:

- EU-type examination certificate
- EU declaration of conformity
- Attestation of conformity
- Certificates
- Control drawings
- Additional documents

## 1.2 Target Group, Personnel

Responsibility for planning, assembly, commissioning, operation, maintenance, and dismounting lies with the plant operator.

Only appropriately trained and qualified personnel may carry out mounting, installation, commissioning, operation, maintenance, and dismounting of the product. The personnel must have read and understood the instruction manual and the further documentation.

Prior to using the product make yourself familiar with it. Read the document carefully.

## 1.3 Symbols Used

This document contains symbols for the identification of warning messages and of informative messages.



## Warning Messages

You will find warning messages, whenever dangers may arise from your actions. It is mandatory that you observe these warning messages for your personal safety and in order to avoid property damage.

Depending on the risk level, the warning messages are displayed in descending order as follows:



### ***Danger!***

This symbol indicates an imminent danger.

Non-observance will result in personal injury or death.



### ***Warning!***

This symbol indicates a possible fault or danger.

Non-observance may cause personal injury or serious property damage.



### ***Caution!***

This symbol indicates a possible fault.

Non-observance could interrupt the device and any connected systems and plants, or result in their complete failure.

## Informative Symbols



### ***Note!***

This symbol brings important information to your attention.



### **Action**

This symbol indicates a paragraph with instructions. You are prompted to perform an action or a sequence of actions.



## 2 Product Specifications

### 2.1 Overview and Application

The FieldConnex<sup>®</sup> Multi-Input/Output device (MIO) for PROFIBUS PA provides discrete inputs, discrete outputs, 1 frequency input, or 1 counter to process control systems. The device is suitable for DIN rail mounting and field installation with different housing options. The F2 type housing is made of sturdy cast aluminum for installation in rough environments. Fieldbus and sensor-actuator cable entries can be selected individually from a range of cable glands. Optionally, either screw terminals or spring terminals can be chosen. Contact your Pepperl+Fuchs representative for further information on housing options.

The device can be installed in hazardous areas Zones 1, 21, 2, 22, and Division 1, 2. PROFIBUS PA and input/output sensor and actuator connections are rated intrinsically safe for installation in Zone 0 and Division 1.

The device provides different configurable modes of operation.

The valve coupler mode allows connecting 4 low-power valves with 2 end position inputs per valve.

The sensor input mode allows connecting up to 12 binary sensors. 4 sensor inputs are designed to support vibrating forks for level control. One of these inputs is designed to support a frequency or counter input.

The MIO is intended to be used as a replacement for Pepperl+Fuchs process interfaces FD0-VC-Ex4.PA and FD0-BI-Ex12.PA.

For device configuration, a device type manager (DTM) for FDT-based frame applications is available. Also, a device description (DD) for the Siemens Process Device Manager (PDM) is available.

### 2.2 Modes of Operation

The device supports 12 hardware channels which can be configured as inputs and outputs. The functional configuration of the channels is determined by selecting a dedicated mode of operation.

#### Valve Coupler Mode

In the valve coupler mode, the channels 1, 4, 7, and 10 are used to control 4 low-power valves. The channels 2, 3, 5, 6, 8, 9, 11, and 12 are used as valve position feedback inputs for NAMUR proximity switches or mechanical switches. Condition monitoring functions like stroke counter, partial stroke test, and travel time survey enable you to detect evolving faults, before they become critical for the process control.

Refer to the technical data of the MIO for specification of compatible valves and sensors. A list of compatible low-power valves and NAMUR sensors are available on the Pepper+Fuchs website.

#### FD0-VC-Ex4.PA Compatibility Mode

This mode allows the use of \*D0-MIO-Ex12.PA\* in an existing installation as a replacement for FD0-VC-Ex4.PA. In order to activate this mode, use the GSD file of FD0-VC-Ex4.PA. The mode is activated during the start-up of cyclic data exchange. Use the device type manager or device description of the \*D0-MIO-Ex12.PA\* to adjust the device parameters according to the replaced FD0-VC-Ex4.PA.

#### PROFIBUS Profile 3.02 Valve Coupler Compatibility Mode

PROFIBUS PA profile 3.02 defines an interoperability mode for a 4-channel valve coupler. The corresponding GSD file is available on the PROFIBUS International website. Use the device type manager or device description of the \*D0-MIO-Ex12.PA\* in order to adjust the device parameters.

**Modes: Valve Coupler, FD0-VC-Ex4.PA Compatibility, PA Profile 3.02 Valve Coupler Compatibility**

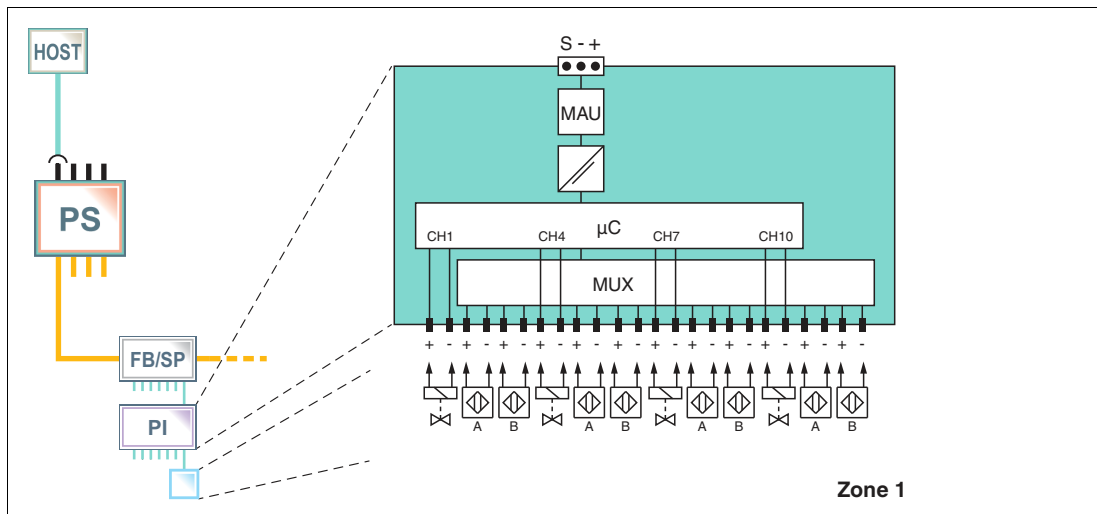

Channel	Description	Valve Coupler Mode
1	VC Channel 1,2,3	Output 1, low-power valve
2		Position feedback sensor/switch A for output 1
3		Position feedback sensor/switch B for output 1
4	VC Channel 4,5,6	Output 2, low-power valve
5		Position feedback sensor/switch A for output 2
6		Position feedback sensor/switch B for output 2
7	VC Channel 7,8,9	Output 3, low-power valve
8		Position feedback sensor/switch A for output 3
9		Position feedback sensor/switch B for output 3
10	VC Channel 10,11,12	Output 4, low-power valve
11		Position feedback sensor/switch A for output 4
12		Position feedback sensor/switch B for output 4

**Sensor Input Mode**

The device samples the inputs in 2 independent cycles. Channels 1, 4, 7, and 10 are intended to be used for sensing multiplexed binary inputs as vibrating forks, NAMUR sensors, or mechanical switches. Channel 1 can also be configured to be used as a frequency or counter input. If the channel 1 frequency or counter input is activated, channels 4, 7, and 10 are deactivated. In the device type manager, the ON-time of channel 1, 4, 7, and 10 can be adjusted individually between 10 ms ... 10 000 ms.

As a parameter, the ON-time of channel 1, 4, 7, and 10 can be adjusted individually between 10 ms ... 11 000 ms. The total cycle time is the sum of the 4 individual ON-times. Channels 2, 3, 5, 6, 8, 9, 11, and 12 are intended to be used for sensing multiplexed binary inputs as NAMUR sensors and mechanical switches. The sampling time of 10 ms is not adjustable. The total cycle time is calculated as follows: number of used channels \* 10 ms (minimum 50 ms). If all 8 sensors are used, the total cycle time is 80 ms.

Refer to the technical data of the MIO for the specification of compatible sensors. A list of compatible NAMUR sensors is available on the Pepperl+Fuchs website.

### FD0-BI-Ex12 Compatibility Mode

This mode allows the use of \*D0-MIO-Ex12.PA\* in an existing installation as a replacement for FD0-BI-Ex12.PA. In order to activate this mode, use the GSD file of FD0-BI-Ex12.PA. The configuration of the FD0.BI-Ex12.PA takes place during the start-up of the cyclic data exchange. The device type manager allows read-only access to the configuration data. No further adjustments are required to update an existing installation with \*D0-MIO-Ex12.PA\*.

### PROFIBUS Profile 3.02 Sensor Input Compatibility Mode

PROFIBUS PA profile 3.02 defines an interoperability mode for a 12-channel sensor input. Use the device type manager or device description of the \*D0-MIO-Ex12.PA\* in order to adjust the device parameters.

#### Modes: Sensor Input, FD0-BI-Ex12.PA Compatibility, PA Profile 3.02 Sensor Input Compatibility

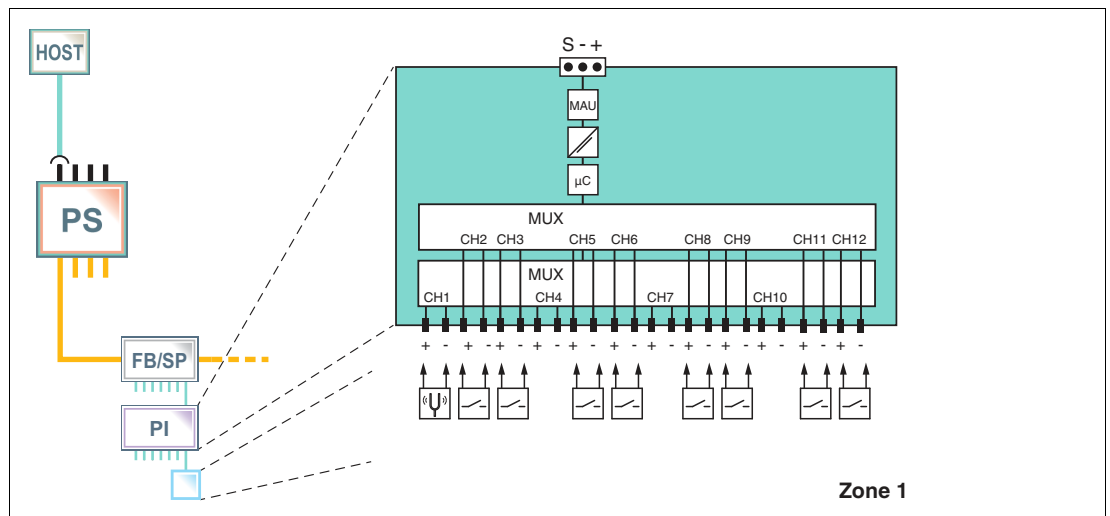

Channel	Sensor Input Modes	Frequency Input Mode	Counter Input Mode
1	Vibration fork or sensor/switch	Frequency input	Counter input
2	Sensor/switch	Sensor/switch	Sensor/switch
3	Sensor/switch	Sensor/switch	Sensor/switch
4	Vibration fork or sensor/switch	Disabled	Disabled
5	Sensor/switch	Sensor/switch	Sensor/switch
6	Sensor/switch	Sensor/switch	Sensor/switch
7	Vibration fork or sensor/switch	Disabled	Disabled
8	Sensor/switch	Sensor/switch	Sensor/switch
9	Sensor/switch	Sensor/switch	Sensor/switch
10	Vibration fork or sensor/switch	Disabled	Disabled
11	Sensor/switch	Sensor/switch	Sensor/switch
12	Sensor/switch	Sensor/switch	Sensor/switch

## 2.3 Hazardous Area Installation and Use

The device may be operated in Zone 1.

For applications in Zone 1, the type of protection must be Ex i according to Entity or FISCO.

The device may be installed in Zone 2.

The type of protection for the trunk interface is Ex ec or Ex ic according to Entity or FISCO.

Independent of the type of protection of the fieldbus interface, the inputs/outputs remain intrinsically safe and may be installed in Zone 1.

### Zone 2



#### **Danger!**

Explosion hazard from live wiring of non-intrinsically safe circuits

If you connect or disconnect energized non-intrinsically safe circuits in a potentially explosive atmosphere, sparks can ignite the surrounding atmosphere.

Only connect or disconnect energized non-intrinsically safe circuits in the absence of a potentially explosive atmosphere.

### Type of Protection "Ex i"



#### **Danger!**

Explosion hazard from wrong separation distances

Non-observance of the separation distances between circuits can result in added currents or voltages. This can result in a current/voltage flashover generating sparks. The sparks can ignite the surrounding potentially explosive atmosphere.

Ensure you observe the compliance of the separation distances according to IEC/EN 60079-14.



#### **Danger!**

Explosion hazard from wrong calculation of verification of intrinsic safety

If you do not consider the maximum permissible peak values of all components when connecting intrinsically safe devices with intrinsically safe circuits of associated apparatus, this can lead to added currents or voltages. This, in return, can result in a current/voltage flashover generating sparks. The sparks can ignite the surrounding potentially explosive atmosphere.

Ensure you observe IEC/EN 60079-14 and IEC/EN 60079-25 for the verification of intrinsic safety.

### Type of Protection "Ex ec"



#### **Danger!**

Explosion hazard from pollution

An excessively polluted surface of the device can become conductive and consequently ignite a surrounding potentially explosive atmosphere.

Ensure that you install the device only in environments with a pollution degree 2 or better according to IEC/EN 60664-1.



**Danger!**

Explosion hazard from exposure to potentially explosive gas atmosphere

If the device is installed in Zone 2 without mounting it in a sufficiently suitable enclosure, gas, dust, water or other external interferences can cause the live device to spark. The sparks can ignite the surrounding potentially explosive atmosphere.

Only mount the device in an enclosure with degree of protection IP54 according to IEC/EN 60529. The enclosure must have an EU declaration of conformity according to the ATEX Directive for at least equipment category 3G.

**Hazardous Area Installation Options**

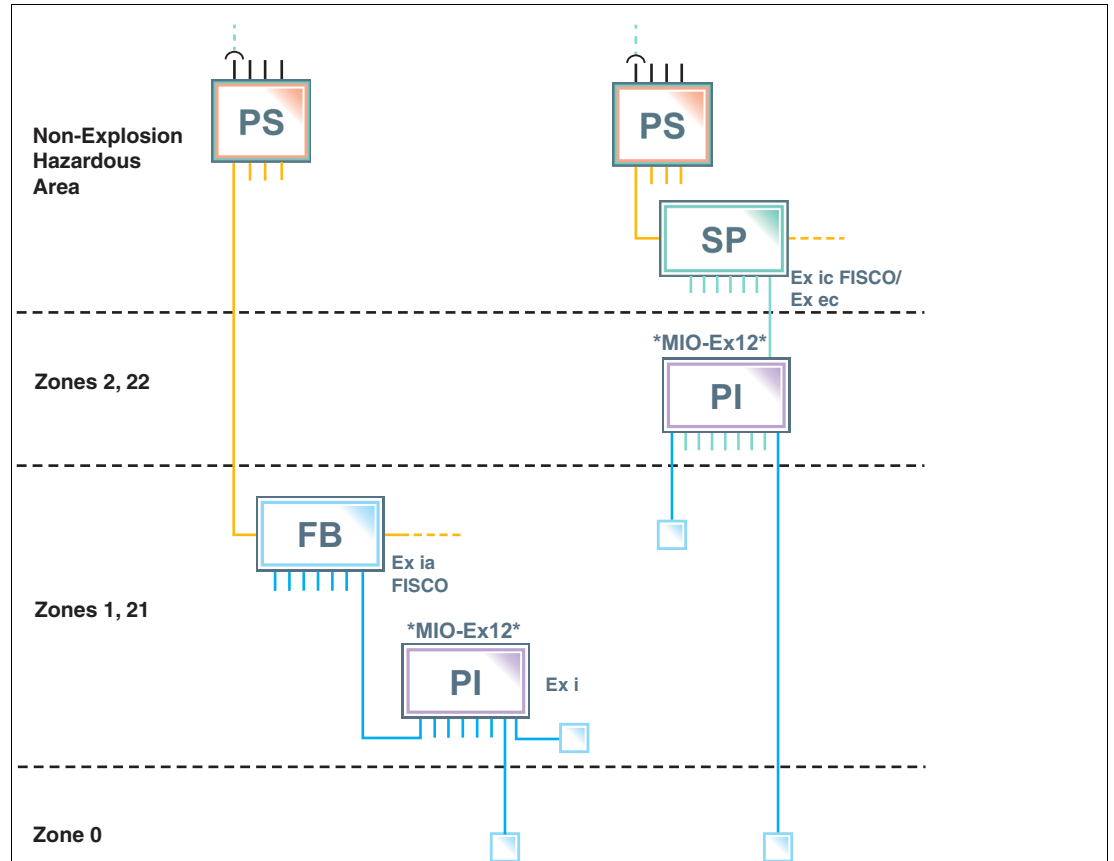

Figure 2.1 Installation options for the multi-input/output device in the hazardous area

Observe the EC-type-examination certificate or the statement of conformity. Pay particular attention to any "special conditions" that may be indicated.

### 3 Installation and Commissioning

In the following section you find information on how to install and commission the multi-input/output (MIO) device in your fieldbus topology.



**Danger!**

Danger to life from using damaged or repaired devices.

Using a defective or repaired device can compromise its function and its electrical safety.

- Do not use a damaged or polluted device.
- The device must not be repaired, changed or manipulated.
- If there is a defect, always replace the device with an original device from Pepperl+Fuchs.



**Danger!**

Explosion hazard from damaged electronic components

Premature wear of electronic components in a device that was previously used in a general electrical installation can cause sparks that can ignite the surrounding potentially explosive atmosphere.

Never install devices that have already been operated in general electrical installations in electrical installations used in combination with hazardous areas!

#### 3.1 Mounting and Dismounting

##### Mounting/Dismounting F2D0-MIO\*

F2D0-MIO\* is designed for panel (wall) mounting.

- Select mounting material that is suitable for the sub-surface (the wall).
- Ensure that the mounting material guarantees secure fastening.
- To attach the device: use 2 fixing screws with a diameter of 6 mm.
- To dismount the device: Undo the fixing screws and take the device off the wall.

##### Mounting/Dismounting R8D0-MIO\*

R8D0-MIO\* is designed for mounting on a 35 mm DIN mounting rail in accordance with EN 50022.

##### Mounting the R8D0-MIO\* Electronics onto the DIN Mounting Rail

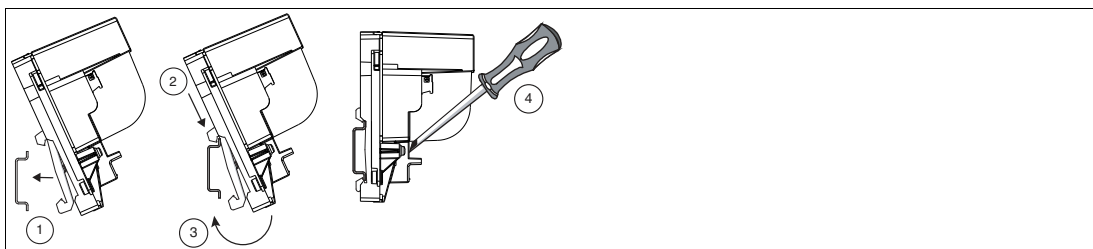

- 1 Place the R8D0-MIO\* on the DIN mounting rail.
- 2 Use the top hook in order to hook the electronics onto the DIN mounting rail.
- 3 Move the bottom hook over the lower end of the DIN mounting rail.
- 4 Tighten the 2 fastening screws to attach the electronics on the DIN mounting rail.  
Tightening torque: 0.4 Nm

To dismount the device: Take off the device in reverse order.

2018-07

## R8D0-MIO\* Installation

Depending on the application, the R8D0-MIO\* must be mounted in a suitable environment.

If mounted in Zone 2 for an Ex ec application, the environment (housing or enclosure) must ensure the following:

- IP54 in accordance with IEC 60529 for hazardous area Zone 2
- Pollution degree 2 or better according to IEC/EN 60664-1

### 3.2 Hardware Installation

#### 3.2.1 R8D0-MIO\* Cable and Connection Information



#### **Danger!**

Explosion hazard from insufficient insulation

Insufficient dielectric strength of insulators between intrinsically safe circuits may lead to interferences and to charge transfers that cause sparks. These sparks can ignite a potentially explosive atmosphere.

Ensure that the dielectric strength of the insulation between intrinsically safe circuits is at least 500 V according to IEC/EN 60079-14.



#### **Danger!**

Explosion hazard or danger to life from inadequate installation of cables and connection lines

If you do not install cables and connection lines according to the instructions given in the instruction manual, this can generate sparks that can ignite the surrounding potentially explosive atmosphere. Furthermore, insufficient installation practice can result in electric shock.

Ensure you carry out any cable gland installations in accordance with the instructions given in the instruction manual.



#### **Danger!**

Explosion hazard from connection damage

Manipulating connections outside of the specified ambient temperature range can lead to material damage, resulting in an unwanted failure of the connection. This could result in an increased explosion hazard in potentially explosive atmospheres.

Only manipulate connections in the specified ambient temperature range.  
Temperature range: -5 C° ... +70 C°



#### **Danger!**

Danger to life from incorrect installation

Incorrect installation of cables and connection lines can compromise the function and the electrical safety of the device.

- Observe the permissible core cross section of the conductor.
- When using stranded conductors, crimp wire end ferrules on the conductor ends.
- Use only one conductor per terminal.
- When installing the conductors the insulation must reach up to the terminal.
- Observe the tightening torque of the terminal screws.

The following section describes the different connection details of the multi-input/output with particular reference to the torques required for a safe installation.

For any terminal connections, observe the following cable and connection information.

### Screw Terminals: Cable and Connection Information

- Permissible core cross section:
  - Screw terminals with flexible or rigid wires: 0.2 mm<sup>2</sup> ... 2.5 mm<sup>2</sup>
- Insulation stripping length: 7 mm
- If you use stranded connectors: Crimp on wire end ferrules
- Ensure that connectors are mechanically locked
- Torque required for tightening terminal screws: 0.5 Nm ... 0.6 Nm

### Spring Terminals: Cable and Connection Information

- Permissible core cross section:
  - Spring terminals with flexible or rigid wires: 0.5 mm<sup>2</sup> ... 2.5 mm<sup>2</sup>
- Insulation stripping length: 10 mm
- Ensure that connectors are mechanically locked
- Torque required for tightening terminal screws: 0.5 Nm ... 0.6 Nm



#### Tip

Double-check that the correct torques are used when un- and reinstalling the terminal during wiring activities!

### Connecting the Trunk

The multi-input/output is connected to the trunk line via designated screw or spring terminals.



#### **Danger!**

Explosion hazard from open or missing trunk terminal cover

If the device is installed Zone 2 and powered by a non-intrinsically safe power source, carrying out hot work on the input/output terminals with an uncovered trunk terminal can lead to contact with solid particles or tools. This can cause the live device to spark. The sparks can ignite the surrounding potentially explosive atmosphere.

Ensure that the trunk terminal cover is present and correctly snapped onto the connector housing to guarantee IP30 rating.



**Trunk Connection with Covered Screw Terminal**

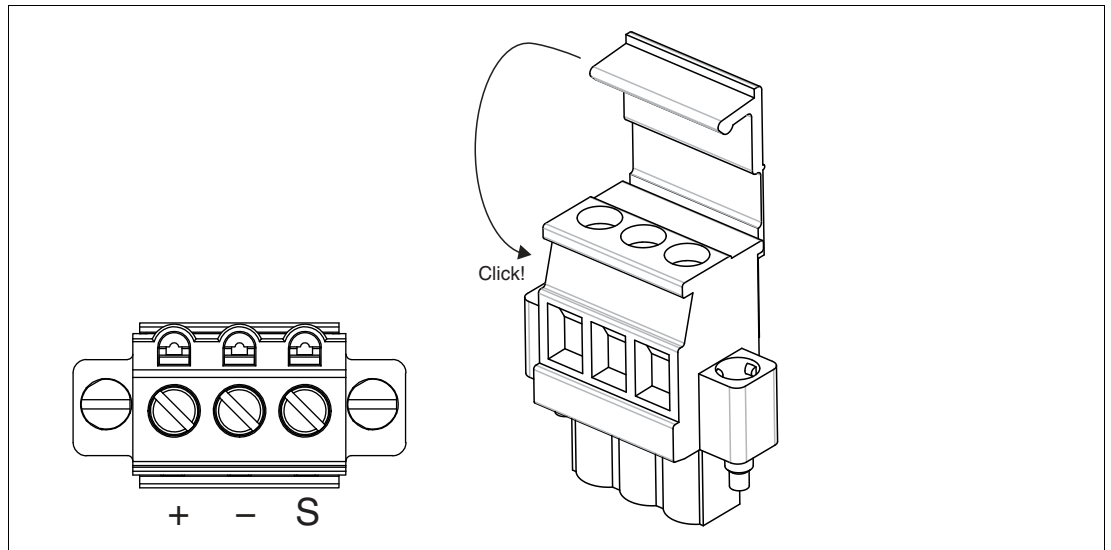

- + Segment +
- Segment -
- S Shield connection

**Trunk Connection with Spring Terminal**



- + Segment +
- Segment -
- S Shield connection

**Multi-Input/Output Screw Terminal**



6-pin screw terminal for multi-inputs/outputs

- + Input/output +
- Input/output -

### Multi-Input/Output Spring Terminal

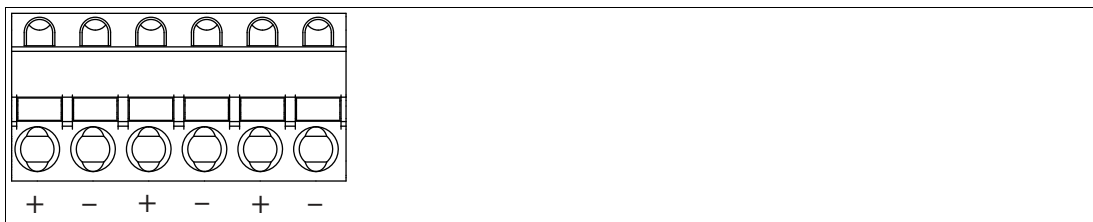

6-pin spring terminal for multi-inputs/outputs

- + Input/output +
- Input/output -

### R8D0-MIO\* Sample Connection Diagram

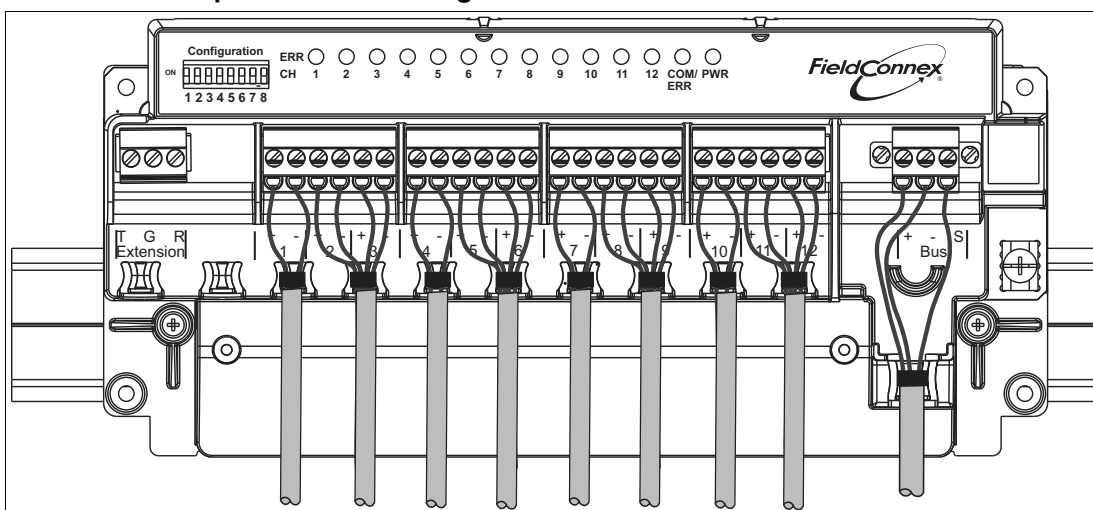

The connection diagram shows the sample connection of the multi-input/output as a valve coupler

### Cable Position Fixture

The R8D0-MIO\* electronics provides special fixtures for cable ties. To keep the cabling in a safe position, use the fixtures with cable ties.

Cable tie width: up to 4 mm

### Using Mechanical Switches

If mechanical contacts are used as valve final position feedbacks, observe the following. The lead breakage and short circuit monitoring can be used after adding series and parallel resistors in the lead. In this case the prerequisites are:

- 1 x 1-kOhm series resistance for monitoring short circuit
- 1 x 10-kOhm parallel resistance for lead breakage detection

### 3.2.2 F2 Housing Degree of Protection

The following section contains information concerning the installation and sealing of the cable glands and the housing cover.



#### ***Danger!***

Explosion hazard or danger to life from inadequate installation of cable glands

If you do not install cable glands according to the instructions given in the instruction manual, this can generate sparks that can ignite the surrounding potentially explosive atmosphere. Furthermore, insufficient installation practice can result in electric shock.

Ensure you carry out any cable gland installations in accordance with the instructions given in the instruction manual.

#### **Fixing the Housing Cover**

Before closing the housing cover: Visually inspect the housing for any visible signs of damage on the cover seal. If damaged, replace the seal with an original seal wear part.

Tightening torque for the screws of the housing cover: 2.5 Nm

#### **General Information on the Installation of Cable Glands**

When installing cable glands, observe the following:

- Only insert permanently laid cables and wires into the cable glands.
  - Ensure that the cables laid do not execute any strain on the cable glands.
  - For permissible cable diameters, refer to the respective datasheet.
- Use an appropriate strain relief clamp, e.g., a suitable cable clamp.
- Seal unused cable glands with a suitable plug or replace them with appropriate screw plugs. Observe the required degree of protection IP66.
  - For a choice of stop plugs and screw plugs, refer to the respective datasheets.
  - Note that the ambient temperature range can be restricted by the stopping plug.
- Protect plastic cable glands against mechanical hazard.
- Ensure you use the correct tightening torques when installing cable glands or plugs. For detail see tables with torque information below.

The specific technical data may vary depending on the type of cable gland or plug you use for your installation. The following cable glands or plug types are documented and information is available at [www.pepperl-fuchs.com](http://www.pepperl-fuchs.com):

Cable Entry Option		Cable Gland or Plug Type
00	Sealing plug plastic: 1 x M20, 8 x M16	SP.PE.M20.PA.C SP.PE.M16.PA.C
01	Sealing plug stainless steel: 1 x M20, 8 x M16	SP.MD.M20.SS.C SP.MD.M16.SS.C
02	Cable glands plastic: 1 x M20, 8 x M16	CG.PEDS.M20.PA.C.10 CG.PIDS.M16S.PA.C.10
03	Cable glands nickel plated brass: 1 x M20, 8 x M16	CG.NA.M20S.BN.C CG.NA.M16.BN.C
04	Cable glands stainless steel: 1 x M20, 8 x M16	CG.NA.M20S.SS.C CG.NA.M16.SS.C
05	Cable glands plastic 5 x M20	CG.PEDS.M20.PA.C.10 CG.PIDS.M20.PA.C.10
		SP.PE.M20.PA.C

#### F2D0-MIO\* Input/Output Cable Glands

Cable Entry Option		Sensor Entries Clamping Ranges: Torques				
		CG or Plug Type	S1+S2+S3	S1+S2	S1	Body
00	1 x M20, 8 x M16 sealing plug plastic	SP.PE.M16.PA.C	-	-	-	1.5 Nm
01	1 x M20, 8 x M16 sealing plug stainless steel	SP.MD.M16.SS.C	-	-	-	4 Nm
02	1 x M20, 8 x M16 cable glands plastic	CG.PIDS.M16S.PA.C.10	-	4 ... 5 mm: 3.5 Nm	5 ... 8 mm: 4 Nm	1.5 Nm
03	1 x M20, 8 x M16 cable glands nickel plated brass	CG.NA.M16S.BN.C	4 ... 6 mm: 20 Nm	6 ... 9 mm: 18 Nm	9 ... 12 mm: 15 Nm	4 Nm
04	1 x M20, 8 x M16 cable glands stainless steel	CG.NA.M16S.SS.C	4 ... 6 mm: 20 Nm	6 ... 9 mm: 18 Nm	9 ... 12 mm: 15 Nm	4 Nm
05	5 x M20 cable glands plastic	CG.PIDS.M20.PA.C.10	-	6 ... 8.5 mm: 5 Nm	7 ... 12 mm: 5 Nm	2 Nm

Table 3.1 The torques that are actually required depend on the clamping range. This range is determined by the diameter of the cable and the resulting seal combinations (S1+S2+S3, S1+S2, S1) used with the cable gland or plug. For details see the documentation on the cable gland or plug type available at [www.pepperl-fuchs.com](http://www.pepperl-fuchs.com).

### F2D0-MIO\* Fieldbus Cable Gland

Cable Entry Option		Fieldbus Entries Clamping Ranges: Torques				
		CG or Plug Type	S1+S2+S3	S1+S2	S1	Body
00	1 x M20, 8 x M16 blind plug plastic	SP.PE.M20.PA.C	-	-	-	2 Nm
01	1 x M20, 8 x M16 blind plug stainless steel	SP.MD.M20.S.S.C	-	-	-	5.5 Nm
02	1 x M20, 8 x M16 cable glands plastic	CG.PEDS.M20.PA.C.10	-	6 ... 8.5 mm: 5 Nm	7 ... 12 mm: 5 Nm	2 Nm
03	1 x M20, 8 x M16 cable glands nickel plated brass	CG.NA.M20S.BN.C	4 ... 6 mm: 20 Nm	6 ... 9 mm: 18 Nm	9 ... 12 mm: 15 Nm	5.5 Nm
04	1 x M20, 8 x M16 cable glands stainless steel	CG.NA.M20S.SS.C	4 ... 6 mm: 20 Nm	6 ... 9 mm: 18 Nm	9 ... 12 mm: 15 Nm	5.5 Nm
05	5 x M20 cable glands plastic	CG.PEDS.M20.PA.C.10	-	6 ... 8.5 mm: 5 Nm	7 ... 12 mm: 5 Nm	2 Nm
05	5 x M20 cable glands plastic	SP.PE.M20.PA.C	Unused thread			2 Nm

Table 3.2 The torques that are actually required depend on the clamping range. This range is determined by the diameter of the cable and the resulting seal combinations (S1+S2+S3, S1+S2, S1) used with the cable gland or plug. For details see the documentation on the cable gland or plug type available at [www.pepperl-fuchs.com](http://www.pepperl-fuchs.com).



**Note!**

**Careful when tightening cap nuts!**

- The cap nuts must be securely tightened. Tightening the cap nuts too much or not enough both can affect the degree of protection.
- The tightening torques of cap nuts vary, depending on the cable type used. For exact details refer to the documentation of your cable manufacturer.

### 3.2.3 Grounding and Shielding

#### Equipotential Bonding of Devices in F2\* Metal Housings

For electronic components in F2\* metal housings in hazardous areas, suitable equipotential bonding in accordance with IEC/EN 60079 is required. Therefore, the device is designed as follows:

- The shield (terminal S) of the intrinsically safe fieldbus trunk is internally connected to the F2\* metal housing.
- The housing has a grounding point with a grounding screw. The grounding connection must be secured against loosening and corrosion, e. g., by using tinned cable plates.



**Note!**

**Ensure potential equalization of F2 Metal Housings**

Ensure that the housing is connected properly to the potential equalization.

## Shielding of the Fieldbus Trunk Using the R\* Electronic Component in Intrinsically Safe Segments

The shield (terminal S) of the fieldbus trunk is internally connected to the grounding point.

### Grounding and Shielding \*D0-MIO-Ex12\*

Shielded cables for the valve or sensor are not required.

The device provides a grounding terminal for connecting to an equipotential bonding.

#### F2D0-MIO-Ex12\* Grounding Points

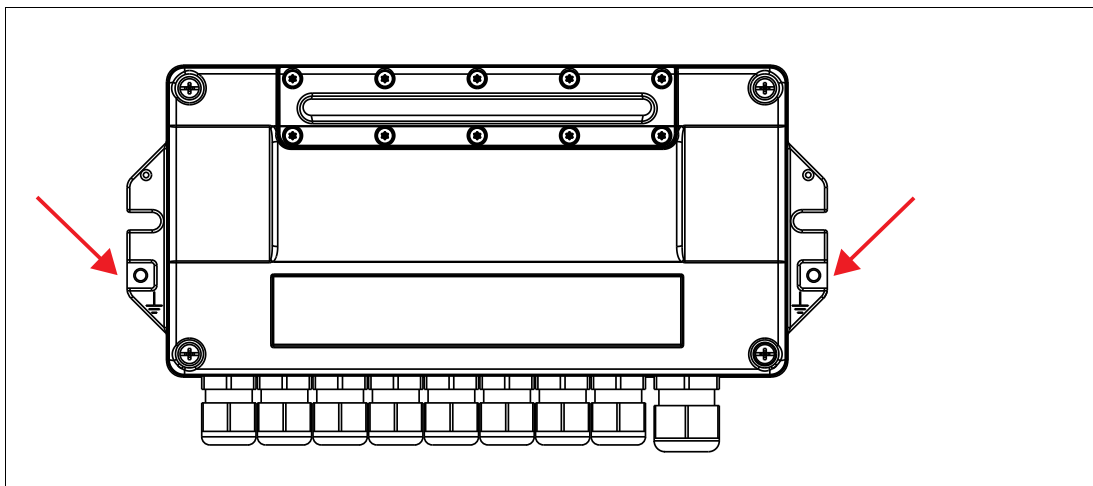

#### R8D0-MIO-Ex12\* Grounding Point

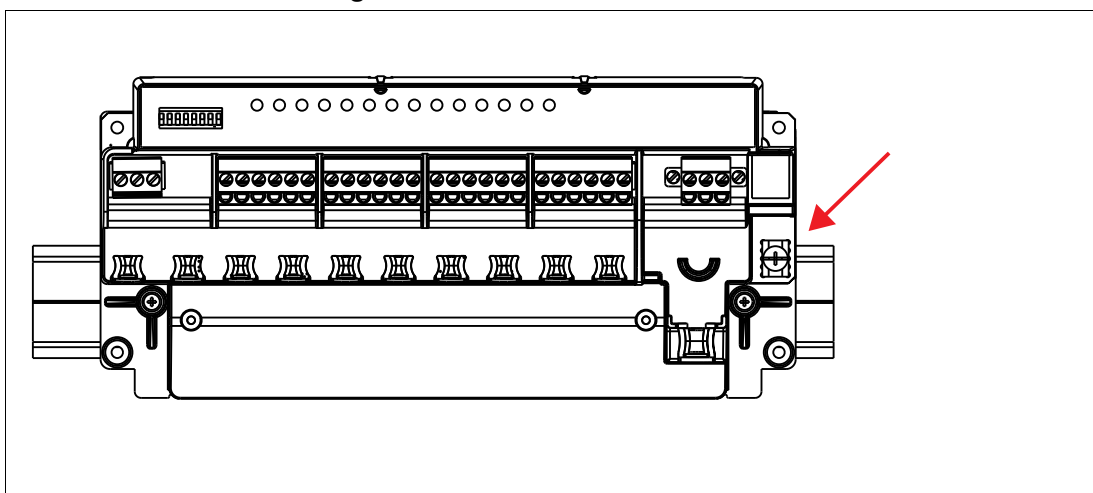

### Connection to Equipotential Bonding System



#### **Caution!**

Risk of electric shock or property damage from inadequate grounding

If you fail to connect all metal parts of the device to protective local earth correctly, this could result in potential equalization currents. These currents could hurt operating personnel or cause property damage.

The grounding terminal is not a safety earth: Do not use the grounding terminal to ground exposed metal parts.

Ground exposed metal parts of the device separately. Ensure that a correct grounding is guaranteed at all times.

All shield connections are internally connected to the "Shield/Screen GND" grounding terminal.

2018-07



## Connecting the Ground Connection Cable



### **Note!**

Use a cable with a minimum cross section of 4 mm<sup>2</sup>.

1. Connect the ground cable to a cable lug.
2. Position the cable lug over the grounding terminal with the cable pointing downwards.
3. Screw the cable lug to the grounding terminal with 2 toothed lock washers inserted between screw, lug, and terminal as illustrated:

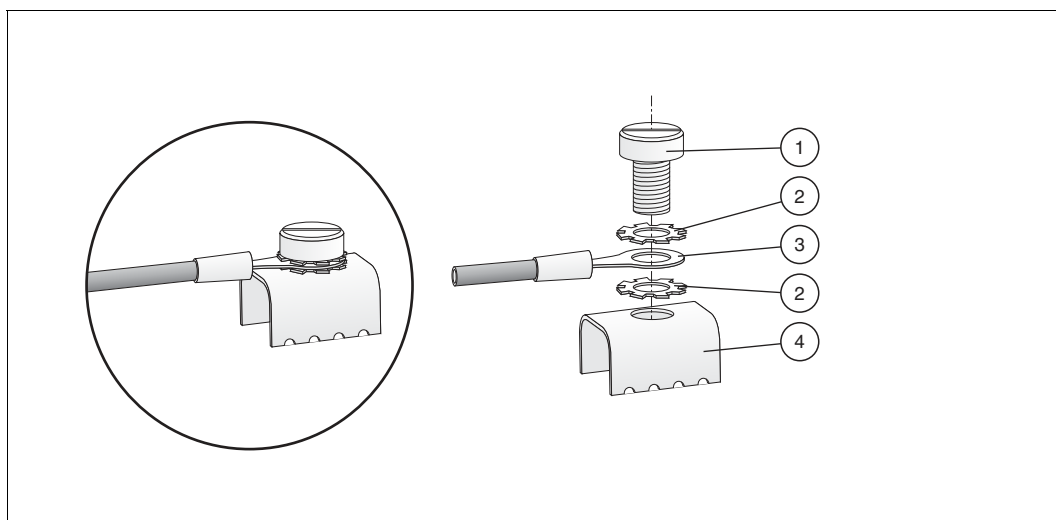

Figure 3.1 Connecting the ground connection cable

- 1 Screw
- 2 Toothed lock washer
- 3 Cable lug
- 4 Grounding terminal on motherboard

4. Tighten the screw with a torque of 1.5 Nm.

↳ The cable lug is properly attached and cannot come loose.

Connect the "Shield/Screen GND" grounding terminal to an equipotential bonding system.

### 3.2.4 DIP Switch Settings

The device has 8 DIP switches:

- DIP switches S1 ... S7: Address setting and binary coding
- DIP switch 8: Write protection settings

#### **Address Settings**

You can assign the PROFIBUS address 0 ... 125 in 2 ways. Use the hardware DIP switches of the device or the device type manager (DTM) software.

In order to assign an address to the multi-input/output (MIO) device in the range of 0 ... 125 as PROFIBUS address, use the DIP switches S1 ... S7.

Any subsequent attempt to change this address via the DTM software is rejected. In this case, the hardware DIP switch settings have priority. To change a hardware address setting again, use the DIP switches.

After modifying the address DIP switches, the device must be rebooted in order to use the new setting. Either disconnect the device from the fieldbus and then reconnect it, or restart the device via the DTM.

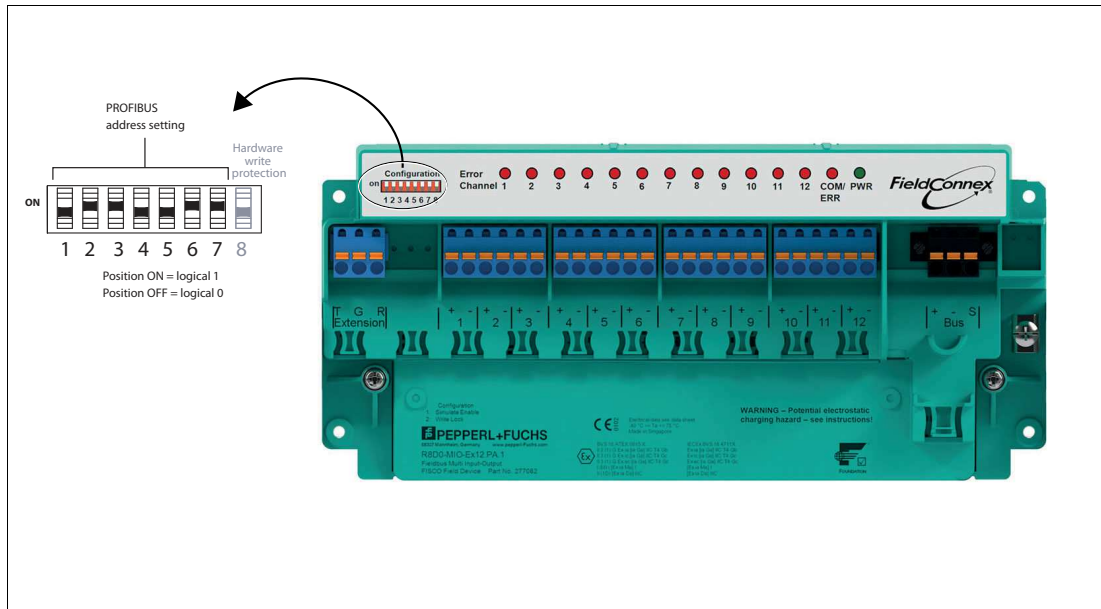

Figure 3.2 DIP switches to set the PROFIBUS address on the device

Address	S1 (2 <sup>0</sup> )	S2 (2 <sup>1</sup> )	S3 (2 <sup>2</sup> )	S4 (2 <sup>3</sup> )	S5 (2 <sup>4</sup> )	S6 (2 <sup>5</sup> )	S7 (2 <sup>6</sup> )
0	OFF	OFF	OFF	OFF	OFF	OFF	OFF
1	ON	OFF	OFF	OFF	OFF	OFF	OFF
...							
126	ON	ON	ON	ON	ON	ON	ON

- By default, the MIO device is delivered with the address set to 126, with the DIP switches S1 ... S7 set to ON. This enables the modification of the address via the bus.
- An address set via the bus remains active, even if the device has been temporarily disconnected from the bus.
- If an address in the range of 1 ... 125 is set via the DIP switches, this address overrides an address previously set via the bus.

### Assigning a PROFIBUS Address via the Device Type Manager

In order to enable software address setting of the MIO device, set the DIP switches either to 126 or 127. For details on how to change the address via the fieldbus, refer to the documentation of your configuration tool.

When the address is changed, the device automatically reboots, using the new address afterwards.

### Write Protection Settings

To protect the parameters from modification you can use write protection.

Write protection has the following effects:

- Acyclic write access is blocked



Activate write protection in either of the following ways:

- Hardware write protection: Use DIP switch 8 on the device (see below).
- Software write protection: Activate the respective parameter in the DTM software. For more information see description of user interface no. 8, see chapter 10.2.3.

### Activating Write Protection via the DIP Switch

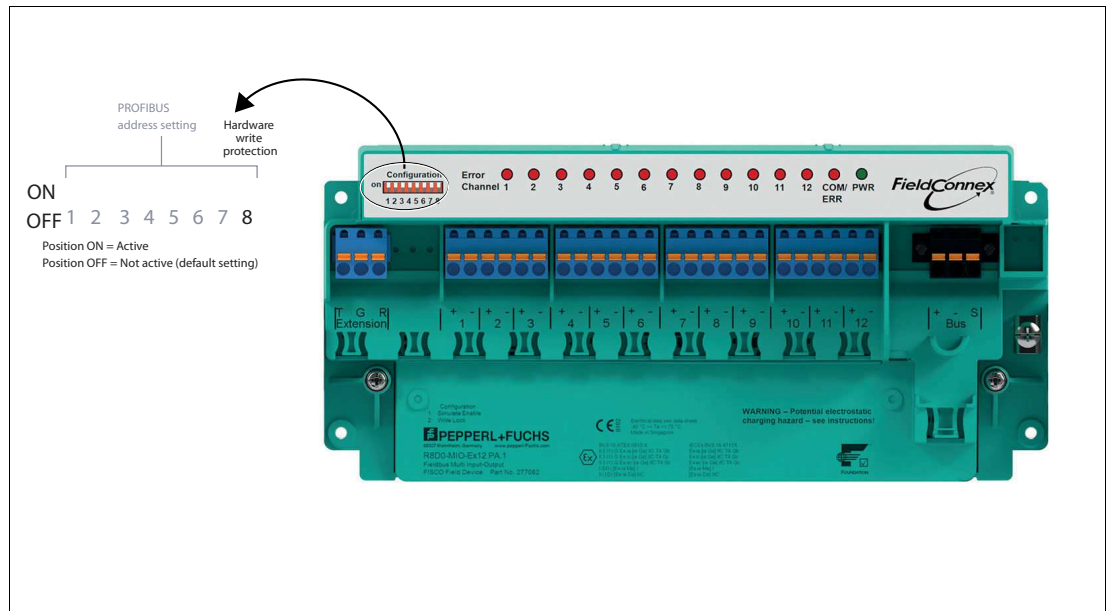

Figure 3.3 DIP switch 8 to activate the hardware write protection

Both write protection methods work the same way, regardless of which one is activated.

## 3.3 PROFIBUS Ident Number Setting

For each PROFIBUS field device type of each manufacturer at least 1 unique PROFIBUS ident number is assigned for device identification. \*D0-MIO-Ex12.PA support different ident numbers and thus, different GSD files, to configure the required mode of operation.

Depending on the required mode of operation of the device, select the ident number in the device type manager (DTM) software. Use the PROFIBUS Ident Number parameter.

For setting the PROFIBUS ident number, see chapter 10.4 and see chapter 10.3.

### Manufacturer-Specific MIO Mode Ident Number

- Manufacturer-specific MIO mode ident number: **0x0F8B**

For selecting the corresponding device mode in the DTM, see chapter 10.4 and see chapter 10.3.

### FD0-VC-Ex4.PA Compatible Mode Ident Number

- FD0-VC-Ex4.PA compatible mode ident number: **0x0841**

### FD0-BI-Ex12.PA Compatible Mode Ident Number

- FD0-BI-Ex12.PA compatible mode ident number: **0x0461**

### PROFIBUS Profile 3.02 Valve Coupler Mode Ident Number

- PROFIBUS profile 3.02 valve coupler mode ident number: **0x9733**

### PROFIBUS Profile 3.02 Sensor Input Mode Ident Number

- PROFIBUS profile 3.02 sensor input mode ident number: **0x972B**



**Note!**

**Automatic Mode**

By default, the device is set to "Automatic" mode: In the process of establishing cyclic communication, the device checks if one of the supported ident numbers is set. If so, the device automatically uses that number.

### 3.4 Requirements for Commissioning

Before commissioning the multi-input/output device (MIO), ensure that the following requirements are met:

- For acyclic communication/parameterization: A suitable FDT frame application is in place in order to parameterize the MIO via a PROFIBUS DP master. The device type manager (DTM) needed to run in the FDT frame application can be downloaded from Internet under [www.pepperl-fuchs.com](http://www.pepperl-fuchs.com). Refer to the release notes of the DTM for information on the frameworks that are supported. The release notes are included in the FieldConnex<sup>®</sup> DTM package.
- For cyclic communication/configuration: A process control system (PCS) is prepared to configure cyclic user data exchange via a PROFIBUS DP Master Class I.
- The PROFIBUS master is connected to a PROFIBUS DP segment. No DP slaves need to be available at the DP segment.
- A PROFIBUS PA segment is connected via a Segment Coupler.
- The bus terminations at both ends of the PROFIBUS PA segment are mounted or switched ON.
- A MIO device is installed at the PROFIBUS PA segment.

### 3.5 Parameterization and Configuration Procedure

Use the FDT frame application with the device type manager (DTM) to parameterize the device. Parameterization is an "acyclic" communication, i. e., read/write data is read from or stored on the device as needed. This also means that once set in the DTM, the parameters are kept even if the device is put into operation at a later point.

Use the following checklist when commissioning the device. Skip those steps you have already completed. For detailed information on how to proceed, refer to the chapters mentioned.

**Parameterization (hardware and software):**

1. Set a fixed valid PROFIBUS address 0 ... 125 via the DIP switch of the device or set the address 126 (default setting) for assignment of the address via the configuration or parameterization tool. For more information, see chapter 3.2.4 or see chapter 10.3, and see chapter 10.4.
2. Set the parameters for the devices in your project, e. g., PROFIBUS ident number, description parameters. For more information see chapter 3.3 and see chapter 10.3/see chapter 10.4.
3. Set channel-related parameters. For more information, see chapter 8.
4. If needed, activate the hardware or software write protection to protect the parameters from overwriting. For more information, see chapter 3.2.4 or description of user interface no. 8, see chapter 10.2.3.

**Configuration:**

1. Log on to the DP master.
2. Select the GSD file to be used (manufacturer-specific, profile-specific). For more information, see chapter 3.2.  
If necessary, install the respective GSD file.

## 4 Configuration

### 4.1 Host System Integration

The configuration of the device in a PROFIBUS network requires a GSD file. The file describes the details of communication capabilities and structures of cyclic data. For the \*D0-MIO-Ex12.PA, different GSD files are available to support different modes of operation.

Mode of operation	Ident number	GSD file
MIO	0x0F8B	PF00F8B.gsd
FD0-VC-Ex4.PA compatibility	0x0841	PF00841.gsd
FD0-BI-Ex12.PA compatibility	0x0461	PF00461.gsd
PROFIBUS profile 3.02 valve coupler	0x9733	PA09733.gsd

The manufacturer-specific GSD files for MIO mode of operation offer the full functionality of the devices. The GSD file is available on the Internet under [www.pepperl-fuchs.com](http://www.pepperl-fuchs.com).

The profile-specific GSD files are defined by the PROFIBUS PA profile 3.02. The GSD files offer a limited, standardized functionality that guarantees interoperability between devices of different manufacturers. Profile-specific GSD files are available on the Internet under [www.pepperl-fuchs.com](http://www.pepperl-fuchs.com).

The FD0-VC-Ex4.PA and FD0-BI-Ex12.PA GSD files are used if in an existing installation of a device has to be replaced. The GSD files of preceding Pepperl+Fuchs process interfaces are available on the Internet under [www.pepperl-fuchs.com](http://www.pepperl-fuchs.com).

### 4.2 Configuration of Cyclic Communication

Prerequisite: The GSD file is installed in your process system. For more information, see chapter 4.1.

During cyclic data exchange, "user data" is exchanged in regular intervals between the master and the slave or bus, e. g., between a process control system and a field device. User data includes, e. g., measurement values, limit position feedback, and output data, etc. The bus cycle time depends on the number of nodes and the amount of data that is transmitted.

The cyclic data is represented in so called "modules" which are mapped to slots. For each hardware channel a module can be selected. The module data consists of a combination of input and output data of different variables. Modules of the different operation modes are not allowed to be mixed other than stated below. The supported types of modules are described in the specific GSD files.

Module types for the valve coupler mode and the FD0-VC-Ex4.PA compatibility mode In the valve coupler mode the following variables for cyclic communication are available:

- Empty module: Used if a channel is not used for cyclic communication.
- OUT\_D: Input value and status of position feedback monitor.
- SP\_D: Specified setpoint value of valve position in the "Auto" mode.
- RB\_D: Feedback of valve position and the states of the position feedback inputs and their line fault condition.
- CB\_D: Detailed status, alarm, and fault condition of the valve.
- RIN\_D: Specified setpoint value of host in the "RCas" mode of operation.
- ROUT\_D: Setpoint value feedback to host in the "RCas"mode of operation.

Modules (combination of variables)	Description	Byte length	
		Input	Output
EMPTY_MODULE	Empty module. Used if a channel is not used.	0	0
OUT_D	Input value and status of sensor input	2	0
SP_D	Setpoint value of the valve	2	0
SP_D+RB_D	Setpoint value + position feedback	2	2
SP_D+CB_D	Setpoint value + diagnostics	2	3
SP_D+RB_D+CB_D	Setpoint value + position feedback + diagnostics	2	5
RIN_D+ROUT_D	Setpoint value host	2	2
RIN_D+ROUT_D+CB_D	Setpoint value host + diagnostics	2	5
SP_D+RB_D+RIN_D+ROUT_D+CB_D	Setpoint value host + final position feedback (PFC) + diagnostics	4	7

In the valve coupler mode, up to 12 modules per \*D0-MIO-Ex12.PA are supported.

Module types for the sensor input mode and FD0-BI-Ex12.PA compatibility mode In the sensor input mode, the following variables for cyclic communication are available:

- Empty module: Used if a channel is not used for cyclic communication.
- OUT\_D: Value of the sensor input and the corresponding status information.
- OUT: Value for frequency input with the corresponding status. Not applicable to the FD0-BI-Ex12.PA compatibility mode.
- OUT long: Value for frequency input with the corresponding status. Module description in long format. Not applicable to the FD0-BI-Ex12.PA compatibility mode.
- OUT short: Value for frequency input with the corresponding status. Module description in short format. Not applicable to the FD0-BI-Ex12.PA compatibility mode.
- OUT\_C: Value for counter input with corresponding status. Not applicable to the FD0-BI-Ex2.PA compatibility mode.
- OUT\_C\_RESET: 1 output byte used to reset the sensor input and the corresponding status information.

Modules (combination of variables)	Description	Byte length	
		Input	Output
EMPTY_MODULE	Empty module. Used if a channel is not used.	0	0
OUT_D	Input value and status of the input if binary sensors are used.	2	0
OUT	Input value and status of the input if configured in frequency mode. Not applicable to the FD0-BI-Ex12.PA compatibility mode.	5	0
OUT long	OUT long: Value for frequency input with the corresponding status. Module description in long format. Not applicable to the FD0-BI-Ex12.PA compatibility mode.	5	0
OUT short	OUT short: Value for frequency input with the corresponding status. Module description in short format. Not applicable to the FD0-BI-Ex12.PA compatibility mode.	5	0
OUT_C	Input value and status of the input if configured in counter mode. Not applicable to the FD0-BI-Ex12.PA compatibility mode.	5	0
OUT_C + OUT_C_RESET	Counter input value and corresponding status in combination with counter reset value.	5	1

### 4.3 Cyclic Communication Data Description

The following sections describe the device variables involved in cyclic communication. Most of these variables contain a data part and a status byte. The status supports 2 different sets of coding: the classic status and the condensed status. The condensed status offers gradual prioritized information which is the most suitable to support you with process control and maintenance tasks. Whereas the classic status follows a fixed mapping between failure cause and status message, the condensed status can be configured depending on available failure causes. For more information, refer to the device type manager description on diagnostic and status mapping.

#### 4.3.1 Valve Coupler Mode and FD0-VC Compatibility Mode Variables

The following section offers information on the following valve coupler mode variables:

- SP\_D
- RIN\_D
- RB\_D
- ROUT\_D
- CB\_D
- OUT\_D

## SP\_D

The status of SP\_D influences the control of the valve. The SP\_D variable consists of 2 bytes:

1. The first byte represents the setpoint value of the valve for the "auto" mode of operation of the function block.
2. The second byte represents the status.

Value	Description
0	Set position "closed"
1 ... 255	Set position "open"

Classic Status Value	Mnemonic	Description
0xA0	GOOD (NC)-IFS	(Initiate fail-safe.) Command for control to change to the fail-safe state.
0x80	GOOD (NC)-OK	Valid setpoint value. Recommended to be used as the default value for "GOOD".
>= 0x40	UNCERTAIN GOOD (C) GOOD (NC)	Valid setpoint value All values 40h ... BFh except A0h. Value 80h recommended to be used preferably.
<= 0x3F	BAD	All values 00 h ... 3 Fh.

The setpoint value is only valid if the value of the status byte (second byte) is "GOOD" (NC)-OK" (80h).



### **Note!**

#### **Controlling the Valve**

The setpoint value is not the control value of the valve. Which value opens or closes a valve, depends on the setting of the "invert setpoint" parameter. For more information, see chapter 8.1.



### **Example!**

#### **Setting the Invert Setpoint Parameter**

If the Invert Setpoint parameter is set to "OFF", the setpoint value is not inverted. The setpoint value "0" controls the valve in the "closed" position. Any other setpoint value from 1 ... 255 controls the valve in the "open" position.

If the Invert Setpoint parameter is set to "ON", the coding of the setpoint value is inverted. That means, the setpoint value "0" controls the valve in the "open" position. Any other setpoint value from 1 ... 255 controls the valve in the "closed" position.

## RIN\_D

The variable RIN\_D contains the specified setpoint value of the valve position in the "RCas" mode. Coding is identical to SP\_D.

The relevant status values are:

Classic Status Value	Mnemonic	Description
0xC0	GOOD (C)-OK	Valid setpoint value.
0xC1	GOOD (C)-IA	(Initialization acknowledgment.) Clearance from control system to change to the RCas mode.
0xE0	GOOD (C)-IFS	(Initiate fail-safe.) Command for channel to change to the Auto mode.
< 0xC0	GOOD (NC) UNCERTAIN BAD	Invalid setpoint value. Change to Auto mode.



### Example!

#### Setting the Valve Position

If the variable RIN\_D is 0 with the Invert Setpoint" parameter set to "OFF", the setpoint value is not inverted. The setpoint value "0" controls the valve in the "closed" position. Any other setpoint value from 1 ... 255 controls the valve in the "open" position.

If RIN\_D is 0 with the Invert Setpoint parameter set to "ON", the coding of the setpoint value is inverted. The setpoint value "0" controls the valve in the "open" position. Any other setpoint value from 1 ... 255 controls the valve in the "closed" position.

## RB\_D

The variable RB\_D gives the feedback of the valve position, the states of the position inputs, and their lead faults. The variable consists of 2 bytes: the first byte represents the readback and the second byte represents the status.

The coding of the readback is as follows:

Bit	Description	
0+1	Valve position	0 = unknown, 1 = closed, 2 = open, 3 = intermediate position
2	Position feedback A	0 = actuated, 1 = not actuated
3		0 = no lead short circuit, 1 = lead short circuit
4		0 = no lead breakage, 1 = lead breakage
5	Position feedback B	0 = actuated, 1 = not actuated
6		0 = no lead short circuit, 1 = lead short circuit
7		0 = no lead breakage, 1 = lead breakage

The coding of the status is as follows:

Classic Status Value	Mnemonic	Description
0x80	GOOD (NC)-OK	Feedback value valid.
0x84	GOOD (NC)-UE	(Update event.) 10-s message for parameter changes.
0x0C	BAD (NC)-DF	(Device failure.) Electric hardware fault. Send the device to Pepperl+Fuchs for repair.
0x10	BAD (NC)-SF	Position feedback sensor combination not allowed.
0x11	BAD (NC)-SF	Lead short circuit
0x12	BAD (NC)-SF	Lead breakage

## ROUT\_D

The variable ROUT\_D consists of 2 bytes providing the setpoint value of the valve which is re-transferred by RIN\_D for monitoring and the status. This setpoint value does not include information of the states of the position feedback sensors. The status is mainly used to control the sequence of module change in case of failure.

The coding of the status is as follows:

Classic Status Value	Mnemonic	Description
0xC0	GOOD (C)-OK	Valid setpoint value.
0xC2	GOOD (C)-IR	(Initialization request.) Clearance request from slave to master in order to change to the RCas mode.
0xCC	GOOD (C)-NI	(Not invited.) RCas is not set as the target mode.
0x0C	BAD-DF	(Device failure.) Electric hardware fault. Send device to Pepperl+Fuchs for repair.
0x1C	BAD-OS	(Out of service.) Is set in the OoS mode.



## CB\_D

The variable CB\_D provides detailed status, alarm, and fault signals of the valve. The variable consists of 3 bytes.

The information is bit-coded as follows:

Bit	Description
0	The valve is set to fail-safe state.
1	Unused
2	Unused
3	Unused
4	After a correct switching operation, the valve has left the appropriate end position or the PFCs show an invalid position.
5	Lead breakage of the valve.
6	Lead short circuit of the valve.
7	Unused
8	Valve is in the process of opening.
9	Valve is in the process of closing.
10	Update event. 10-s message while changing the parameters of this channel.
11	The channel is in simulation mode.
12	Unused
13	Unused
14	Valve moved into the mechanical safety position. <ul style="list-style-type: none"> <li>■ In case of fault if fault states = Actuator Fail Action.</li> <li>■ In Manual mode if status of manual setpoint of valve is BAD.</li> </ul>
15	A cyclic functional test is currently carried out.
16	The limit value for the stroke counter has been exceeded.
17	The breakaway time OPEN-CLOSED including tolerance has been exceeded/fallen below.
18	The breakaway time CLOSED-OPEN including tolerance has been exceeded/fallen below.
19	A fault occurred during the cyclic function test of the valve.
20	The transit time OPEN-CLOSED including tolerance has been exceeded/fallen below.
21	The transit time CLOSED-OPEN including tolerance has been exceeded/fallen below.
22	Actuating drive or valve mechanically blocked.
23	Unused

## OUT\_D

The variable OUT\_D consists of 2 bytes. The first byte contains the process value of the sensor, the second byte contains the status of the data.

The structure of the first byte, i. e., the process value of the sensor input, is as follows:

Bit 0	Value of the sensor input	0: low current 1: high current
Bit 1 ... 7	na	Not used

The structure of the second byte, containing the status of the data, is as follows:

Classic Status Value	Mnemonic	Description
0x80	GOOD-OK	No error, the input value is valid.
0x12	BAD-SF	(Sensor failure.) Lead breakage.
0x11	BAD-SF	(Sensor failure.) Lead short circuit.
0x0C	BAD-DF	(Device failure.) Hardware fault.
0x1C	BAD-OS	(Out of specification.) No valid value of the sensor has been read (after power-up of the device).

The values of the position feedback sensors in the MIO valve coupler mode can be transmitted individually to calculate e. g. the position of a valve in the process control system.

### 4.3.2

## Sensor Input Mode and FD0-BI Compatibility Mode Variables

The following section offers information on the following sensor input mode variables:

- **Discrete Input Variables**
- **Frequency and Counter Variables**

### Discrete Input Variables

The variable OUT\_D consists of 2 bytes. The first byte contains the process value of the sensor, the second byte contains the status of the data.

The structure of the first byte, i. e., the process value of the sensor input, is as follows:

Bit 0	Value of the sensor input	0: low current 1: high current
Bit 1 ... 7	na	Not used

The structure of the second byte, containing the status of the data, is as follows:

Classic Status Value	Mnemonic	Description
0x80	GOOD-OK	No error, the input value is valid.
0x12	BAD-SF	(Sensor failure.) Lead breakage.
0x11	BAD-SF	(Sensor failure.) Lead short circuit.
0x0C	BAD-DF	(Device failure.) Hardware fault.
0x1C	BAD-OS	(Out of specification.) No valid value of the sensor has been read (after power-up of the device).

### Frequency Input Variables

The OUT variable consists of 5 bytes. The first 4 bytes contain the process value of the frequency or counter. The 5th byte contains the status of the process value.

The OUT long variable represents the value for the frequency input with the corresponding status. Module description in long format. Not applicable to the FD0-BI-Ex12.PA compatibility mode.

The OUT short variable represents the value for the frequency input with the corresponding status. Module description in short format. Not applicable to the FD0-BI-Ex12.PA compatibility mode.

For the frequency input, the sensor value is formatted in float format according to IEEE 754.

The structure of the 5th byte, containing the input status, is as follows:

Classic Status Value	Mnemonic	Description
0x80	GOOD-OK	No error, the input value is valid.
0x12	BAD-SF	(Sensor failure.) Lead breakage.
0x11	BAD-SF	(Sensor failure.) Lead short circuit.
0x0C	BAD-DF	(Device failure.) Hardware fault.
0x1C	BAD-OS	(Out of specification.) No valid value of the sensor has been read (after power-up of the device).

## Counter Input Variables

The OUT\_C variable consists of 5 bytes. The first 4 bytes contain the process value of the frequency or counter. The 5th byte contains the status of the process value.

For the counter input the sensor value is formatted in unsigned 32.

The structure of the 5th byte, containing the input status, is as follows:

Classic Status Value	Mnemonic	Description
0x80	GOOD-OK	No error, the input value is valid.
0x12	BAD-SF	(Sensor failure.) Lead breakage.
0x0C	BAD-DF	(Device failure.) Hardware fault.
0x1C	BAD-OS	(Out of specification.) No valid value of the sensor has been read (after power-up of the device).

## Counter Output Variable OUT\_C\_RESET

The variable OUT\_C\_RESET contains the reset value in counter mode.

- = 0: Counter is in normal operation.
- > 0: Counter is in reset mode. As long as the counter is in reset mode, the following applies:
  - OUT\_C variable = 0
  - OUT\_C.status = 0x4F (uncertain-initial value-const.)

## 4.4 Cyclic Communication Data Structure

In the following section explains the order of the module data transmitted in the cyclic data exchange.

### 4.4.1 Valve Coupler Mode and FD0-VC-Ex4.PA Compatibility Mode

The length of the module data depends on the module type. For more information, see chapter 4.2.

Byte 1 ... n			
Module data+status CH 1/ output 1	Module data+status CH 4/ output 2	Module data+status CH 7/ output 3	Module data+status CH 10/ output 4

If an "empty" module is used instead of a module containing data, no data is transferred during the data exchange for the corresponding channel.



#### **Note!**

#### **Discrete Input Modules**

Discrete input (DI) modules are supported in the **MIO mode** for valve couplers only. These are the OUT\_D variables of the position feedback sensors. These variables work as described in the section "Discrete Input Variables", see chapter 4.3.2.

#### 4.4.2 Example of a Typical Configuration in Valve Coupler Mode

Out of 4 available valves, valve 2 and valve 3 are assigned.

Lead monitoring is activated both valves: CB\_D

For the valve 3, an additional final position feedback and monitoring is required: RB\_D

The mode of operation for valve 2 is Auto and for valve 3 it is RCas.

In this setup, the list of the modules used should have the following structure:

Pos.	Module	Use
1	EMPTY_MODULE	Valve 1: Empty module as the valve is not used
2	SP_D+CB_D	Valve 2: Specified setpoint value of valve with fault feedback in Auto mode.
3	SP_D+RB_D+RIN_D+ROUT_D+CB_D	Valve 3: Specified setpoint value of valve with fault feedback and final position monitoring (likewise with fault feedback) in RCas mode. The identifier must contain the RB_D variable for the final position feedback.
4	EMPTY_MODULE or no specification	Valve 4: Empty module or no assignment as the valve is not used and no used channels follow.

The length of the user data transferred to the device (output data) is:  $0 + 2 + 4 + 0 = 6$  bytes

The length of the user data transferred from the device (input data) is:  $0 + 3 + 7 + 0 = 10$  bytes

#### 4.4.3 Sensor Input Mode and FD0-BI-Ex12.PA Compatibility Mode

Example: Binary sensor input only, channels 1 ... 12:

- Channels 1, 4, 7, 10: sensor measurement group 1
- Channels 2, 3, 5, 6, 8, 9, 11, 12: sensor measurement group 2

Byte	1	2	3	4	5	6	7	8	9	10	11	12	...	23	24
Content	Data CH1	Status CH1	Data CH4	Status CH4	Data CH7	Status CH7	Data CH10	Status CH10	Data CH2	Status CH2	Data CH3	Status CH3	...	Data CH12	Status CH12

Example:

Combined frequency or counter and sensor input:

- Channel 1: frequency or counter input
  - Channels 2, 3, 5, 6, 8, 9, 11: sensor inputs
- Note: Channels 4, 7, and 10 are empty modules and cannot receive data.

Byte	1 ... 4	5	6	7	8	9	10	...	18
Content	Data CH1	Status CH1	Data CH2	Status CH2	Data CH3	Status CH3	Data CH5	...	Status CH11

If an "empty" module is used instead of a module containing data, no data is transferred during the data exchange for the corresponding channel.

#### 4.4.4 Example of a Typical Configuration in Sensor Input Mode

Out of 4 available vibrating forks, fork 1 and fork 3 are used.

Out of the 8 available sensors, sensor 2 and sensor 3 are used.

Settling time of the vibrating forks that is set: 4 s.

In this setup, the list of the modules used should have the following structure:

Pos.	Module	Use
1	OUT_D	Vibrating fork 1
2	EMPTY_MODULE	Vibrating fork 2 is not used
3	OUT_D	Vibrating fork 3
4	EMPTY_MODULE	Vibrating fork 4 is not used
5	EMPTY_MODULE	Sensor 1 is not used
6	OUT_D	Sensor 2
7	OUT_D	Sensor 3
8 ... 12	EMPTY_MODULE	Sensor 4 ... 8 is not used

A typical parameterization string is, e. g.: 00 00 00 53 01 02 01 03 02 01

##### Explanation

00 00 00	53	01	02	03	03	02	01
3 bytes = always "0"	Configuration byte for fork 1, incl. settling time setting	Fork 2, deactivated	Fork 3, deactivated	Fork 4, deactivated	Sensor 1, deactivated	Sensor 2	Sensor 3

At maximum, 5 more bytes could follow for the sensors 4 ... 8.

During the cyclic user data exchange, the following 8 bytes are transferred:

1. Byte	2. Byte	3. Byte	4. Byte	5. Byte	6. Byte	7. Byte	8. Byte
Data Fork1	Status Fork1	Data Fork3	Status Fork3	Data Sens2	Status Sens2	Data Sens3	Status Sens3

## 5 Parameterization in Cyclic Communication (Set\_Prm)

### 5.1 Condensed Status and Diagnosis

The device supports the classic and condensed status and diagnostic messages. For more information, see chapter 6.3. During parameterization it is possible to switch between the modes. The PRM\_COND parameter defines whether the condensed status and diagnostic status are enabled or disabled.



**Note!**

**Compatibility Modes**

The FD0-VC-Ex4.PA and FD0-BI-Ex12 compatibility modes only support the classic status!

### 5.2 FD0-BI-Ex12 Compatibility Mode

In the FD0-BI-Ex12 compatibility mode, the device can be configured by using the PRM\_DATA PROFIBUS parameterization string. For each of the 12 sensor inputs/modules 1 byte is transmitted. The first byte contains the lead breakage and lead short circuit option and the settling time for CH1, CH4, CH7, and CH10. The following bytes contain the lead breakage and lead short circuit option for the CH2 ... CH12.

Content of the first parameterization byte:

Bit 7	Bit 6	Bit 5	Bit 4	Bit 3	Bit 2	Bit 1	Bit 0
Settling for the sensor inputs of the hardware channels, 1, 4, 7, and 10				Lead breakage, lead short circuit settings			

**Coding of the lead breakage/lead short circuit settings (bit 0 ... 4):**

- 0: Lead breakage + short circuit check (LB and SC checks are activated)
- 1: Lead breakage check (LB check is activated)
- 2: Short circuit check (SC check is activated)
- 3: No check (LB is deactivated)

**Coding of the settling time settings (bit 5 ... 7):**

- 0: 1 s (default)
- 1: 250 ms
- 2: 500 ms
- 3: 2 s
- 4: 3 s
- 5: 4 s
- 6: 5 s

The parameterization bytes 2 ... 12 have the following content:

Bit 7	Bit 6	Bit 5	Bit 4	Bit 3	Bit 2	Bit 1	Bit 0
Not used				Lead breakage, lead short circuit settings			

**Coding of the lead breakage/lead short circuit settings (low nibble):**

- 0: Lead breakage + short circuit check (LB and SC checks are activated)
- 1: Lead breakage check (LB check is activated)
- 2: Short circuit check (SC check is activated)
- 3: No check (LB check is deactivated)

For sensors that are configured as empty modules, the lead breakage and lead short circuit checks are deactivated independently of the content of their parameterization byte.



## 6 Troubleshooting and Diagnosis

The following information helps you to identify problems with the multi-input/output device and interpret diagnostic issues.

### 6.1 LED Status and Error Indication

The device is providing LED indication for each channel, the communication status and the fieldbus voltage.

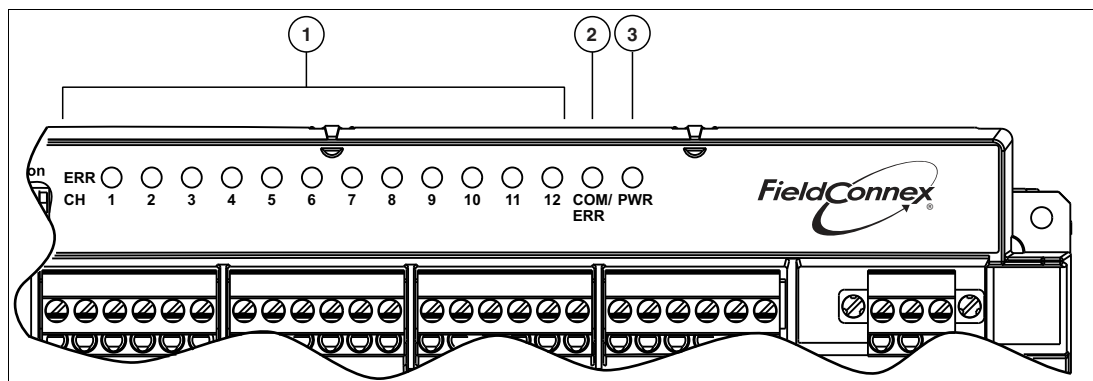

- 1 LED CH ERR 1 ... 12 for indicating channel errors
- 2 LED COM ERR for indicating communication errors
- 3 LED PWR for indicating operation

LED	Indication	Color	Information	Reason	Remedy
CH ERR	Flashing	Red	Status of the corresponding channel	Lead breakage or short circuit of valve or sensor connection. Only available if wire check is activated and mode of operation is not "out of service".	Check the cable wires.
	OFF	--		Channel works as expected.	--
COM ERR	ON	Red	Communication status.	Hardware error.	Hardware error in the device. Check the device and replace if required.
	Flashing	Red		No communication activity.	Device is not configured for cyclic communication. Check the PROFIBUS master.
	OFF	--		Cyclic communication with master, class I.	--
PWR	ON	Green	Status of the fieldbus power.	Fieldbus voltage at the trunk.	--
	OFF	--		No fieldbus voltage at the trunk.	Check the fieldbus power supply. Check the trunk cable.

## 6.2 Device Internal Errors

The device detects internal error conditions that impact the following aspects:

- Status information of cyclic data: For more information: configuration of cyclic communication see chapter 4.2, cyclic communication data structure see chapter 4.4, initialization run (valve coupler) see chapter 6.4.
- Diagnostic content. For more information, see chapter 6.3.
- COM ERR LEDs: For more information, see chapter 6.1.

Error	Description	Impact on
Hardware IO	<ul style="list-style-type: none"> <li>■ Internal communication between fieldbus board and IO board failed</li> <li>■ Hardware error on IO board</li> </ul>	Condensed status: <ul style="list-style-type: none"> <li>■ Hardware error</li> </ul> Classic diagnosis: <ul style="list-style-type: none"> <li>■ Hardware error</li> </ul> Field diagnostics: <ul style="list-style-type: none"> <li>■ Device failure</li> </ul> LEDs: <ul style="list-style-type: none"> <li>■ COM ERR LED: ON</li> </ul>
Hardware memory	<ul style="list-style-type: none"> <li>■ Nonvolatile memory verification failed</li> <li>■ Nonvolatile memory write access failed</li> </ul>	Classic diagnosis: <ul style="list-style-type: none"> <li>■ Memory error</li> </ul> Field diagnostics: <ul style="list-style-type: none"> <li>■ Device failure</li> </ul> LEDs: <ul style="list-style-type: none"> <li>■ COM ERR LED: ON</li> </ul>

## 6.3 Diagnosis

The PROFIBUS PA profile defines 2 different diagnostic modes supported by the device:

- Classic diagnosis
- Condensed diagnosis

The condensed diagnosis gives more structured and focused information of the device tailored for the use in process systems and maintenance stations. You can adapt failure causes that change the diagnostic state according to your needs. For more information, refer to the device type manager (DTM).

Bytes 1 ... 10 of the diagnostic extension and the diagnostic structures are identical.

The diagnostic mode can be changed via the device type manager (DTM) or via the PRM\_COND user parameter. The parameters are transmitted from the PROFIBUS host to the device to during start-up of the device.

In the compatibility modes for FD0-BI-Ex12 and FD0-VC-Ex4.PA and the profile-3.02-specific modes, only classic diagnosis is available. All other device modes support classical and condensed diagnosis.

**Classic Device Diagnosis**

Byte	Bit	Diagnosis	Description
1 ... 10	all	--	Standard PROFIBUS diagnostic information
11	0	Hardware error	Is set if the device detects internal hardware errors.
	1 ... 3	Not used	Not supported, set to 0.
	4	Memory error	Is set if EEPROM checksum verification fails or EEPROM was cleared.
	5 ... 6	Not used	Not supported, set to 0.
	7	Not used	Not supported, set to 0.
12	0 ... 4	Not used	Not supported, set to 0.
	5	Maintenance required	Is set in either of the following instances: <ul style="list-style-type: none"> <li>■ Total valve travel limit is exceeded</li> <li>■ The valve is mechanically blocked</li> <li>■ Limit for break time from OPEN to CLOSE exceeded</li> <li>■ Limit for break time from CLOSE to OPEN exceeded</li> <li>■ Limit for transit time from OPEN to CLOSE exceeded</li> <li>■ Limit for transit time from CLOSE to OPEN exceeded</li> <li>■ Valve wire check indicates a LB or SC</li> <li>■ Sensor A wire check indicates a LB or SC</li> <li>■ Sensor B wire check indicates a LB or SC</li> <li>■ Sensor wire check indicates a LB or SC</li> </ul>
	6	Not used	Not supported, set to 0.
	7	Not used	Not supported, set to 0.
13	0 ... 7	Not used	Not supported, set to 0.
14	0 ... 6	Not used	Not supported, set to 0.
	7	EXTENSION_AVAILABLE	If 1, more diagnostic information is available.
15	0	Hardware error	Is set if the device detects internal hardware errors.
	1	Memory error	Is set if the device detects an internal memory error.
	2 ... 7	Not used	Not supported, set to 0.

Byte	Bit	Diagnosis	Description
16	0	CH1 valve mechanical error	In valve coupler mode output 1: Is set in either of the following instances: <ul style="list-style-type: none"> <li>■ Valve is mechanically blocked</li> <li>■ Actual position feedback differs from expected position</li> </ul>
	1	CH1 valve mechanical warning	In valve coupler mode output 1: Is set in either of the following instances: <ul style="list-style-type: none"> <li>■ Total valve travel limit is exceeded</li> <li>■ Limit for break time from OPEN to CLOSE exceeded</li> <li>■ Limit for break time from CLOSE to OPEN exceeded</li> <li>■ Limit for transit time from OPEN to CLOSE exceeded</li> <li>■ Limit for transit time from CLOSE to OPEN exceeded</li> </ul>
	2	CH1 valve wire error	Is set if the valve wire check indicates an LB or SC.
	3	CH1 stroke counter limit exceeded	Is set if the total valve travel limit is exceeded.
	4	CH2 sensor A wire error	Is set if channel 2 wire check indicates an LB or SC.
	5	CH3 sensor B wire error	Is set if channel 3 wire check indicates an LB or SC.
	6	CH1 sensor wire error	Is set if channel 1 wire check indicates an LB or SC.
	7	Not used	Not supported, set to 0.

Byte	Bit	Diagnosis	Description
17	0	CH4 valve mechanical error	Description see byte 16 for CH4 ... CH12.
	1	CH4 valve mechanical warning	
	2	CH4 valve wire error	
	3	CH4 stroke counter limit exceeded	
	4	CH5 sensor A wire error	
	5	CH6 sensor B wire error	
	6	CH4 sensor wire error	
	7	Not used	
18	0	CH7 valve mechanical error	
	1	CH7 valve mechanical warning	
	2	CH7 valve wire error	
	3	CH7 stroke counter limit exceeded	
	4	CH8 sensor A wire error	
	5	CH9 sensor B wire error	
	6	CH7 sensor wire error	
	7	Not used	
19	0	CH10 valve mechanical error	
	1	CH10 valve mechanical warning	
	2	CH10 valve wire error	
	3	CH10 stroke counter limit exceeded	
	4	CH11 sensor A wire error	
	5	CH12 sensor B wire error	
	6	CH10 sensor wire error	
	7	Not used	
20	0 ... 7	Not used	Not supported, set to 0.

### Condensed Device Diagnosis

Byte	Bit	Diagnosis	Description
1 ... 10	all	-	Standard PROFIBUS diagnosis information
11	0 ... 7	Not used	Not supported, set to 0.
12	0 ... 2	Not used	Not supported, set to 0.
	3	Not used	Not supported, set to 0.
	4	Not used	Not supported, set to 0.
	5	Maintenance required	See classic diagnosis.
	6	Not used	Not supported, set to 0.
	7	Not used	Not supported, set to 0.
	13	0	Maintenance alarm
1		Maintenance demanded	Cause of the alarm is user-selectable. For DTM description, see chapter 10.2.
2		Function check	Cause of the alarm is user-selectable. For DTM description, see chapter 10.2.
3		Invalid process conditions	Cause of the alarm is user-selectable. For DTM description, see chapter 10.2.
4 ... 7		Not used	Not supported, set to 0.
14	0 ... 6	Not used	Not supported, set to 0.
	7	EXTENSION_AVAILABLE	0: No more information available. 1: More diagnostic information is available in DIAGNOSIS_EXTENSION.
15 ... 20	all	See classic diagnosis	See classic diagnosis

## 6.4 Initialization Run (Valve Coupler Mode)

An initialization run is used to automatically teach in the Actuator Fail Action (mechanical safety position) parameter and the reference values for the breakaway and transit times and their tolerances. The initialization run must be carried out individually for each channel. Whether and how the initialization run can be started, depends on the parameterization tool used.

During the initialization run, several fault conditions can occur that are related to the connected valves or position feedback sensors (PFC).

**Possible Faults during the Initialization Run**

<b>Fault signal occurs ...</b>	<b>Situation/Possible Cause</b>	<b>Remedy</b>
... prior to start:	Valve is correctly set.	Restart the initialization run after the valve has reached the set position.
	Lead breakage or short circuit at PFCs or the auxiliary valve.	Check wiring of sensors and auxiliary valve.
	Valve is in wrong position.	Check PFCs for connection and proper functioning. Check parameterization of the Sensor Usage. Check parameterization of the Actuator Fail Action. Check auxiliary power. Check mechanical drive.
... when carrying out the tests:	The PFCs indicate an unexpected valve position. Open - intermediate - closed or vice versa is expected.	Check PFCs for connection and correct functioning.
	Breakaway time exceeds 1 min.	Mechanical drive or auxiliary valve defective. Check PFCs for connection and correct functioning.
	Transit time exceeds 3 min.	Mechanical drive or auxiliary valve defective. Check PFCs for connection and correct functioning.
	The line test revealed a fault.	Check LEDs and diagnostic messages. Check wiring of PFCs and valve.

### RB\_D Status Information

Status Information (Mnemonic)	Cause	Remedy	For more information ...
BAD-O/S	Channel is in mode "O/S" (out of service).	Set target mode to "Auto", "RCas" or "Man".	See chapter 8.2
BAD-DF	Hardware fault: <ul style="list-style-type: none"> <li>■ LED "COM/ERR" lights up permanently, and</li> <li>■ the slave diagnosis indicates a hardware fault.</li> </ul>	Send the device to Pepperl+Fuchs for repair.	Variables RB_D and CB_D: see chapter 4.3.1 Description of diagnosis: see chapter 6.3
BAD-SF	Lead interruption of sensor.	Determine the affected sensor via the variable RB_D.	Variable RB_D: see chapter 4.3.1
BAD-SF	Lead short circuit of sensor.	Determine the affected sensor via the variable RB_D.	Variable RB_D: see chapter 4.3.1
BAD-SF	"Not allowed sensor combination": The feedback of the PFCs is not assigned to a valve position.	<ul style="list-style-type: none"> <li>■ Check the parameterization of the Sensor Usage.</li> <li>■ Check the PFCs for correct functioning.</li> </ul>	Sensor Usage: see chapter 8.3.2
GOOD (NC)-UE	Parameters have been modified.	After 10 seconds, this event information is reset automatically.	Variable RB_D: see chapter 4.3.1

### ROUT\_D Status Information

Status Information (Mnemonic)	Cause	Remedy	For more information ...
BAD-O/S	Channel is in mode "O/S" (out of service).	Set target mode to "Auto", "RCas", or "Man".	Introduction modes of operation: see chapter 8.2
BAD-DF	Hardware fault: <ul style="list-style-type: none"> <li>■ LED "COM/ERR" lights up permanently, and</li> <li>■ the slave diagnosis indicates a hardware fault.</li> </ul>	Send the device to Pepperl+Fuchs for repair.	Variable RB_D: see chapter 4.3.1 Description of diagnosis: see chapter 6.3
GOOD (C)-IR	Channel has changed to mode "Auto".	Eliminate the fault that caused the control system to set the status RIN_D to BAD. Next, acknowledge with the status "GOOD (C)-IA".	Introduction modes of operation, RCas: see chapter 8.2
GOOD (C)-NI	ROUT_D was used, although "RCas" was not set as the target mode.	Set the target mode "RCas".	Variable ROUT_D: see chapter 4.3.1

2018-07



## 7 Device-Related Parameters

This section describes the device-related parameters for device identification and device documentation.

### 7.1 Device Identification

#### **PROFIBUS Ident Number**

A PROFIBUS ident number is assigned to each field device type of each manufacturer for unambiguous identification throughout the PROFIBUS network. This ident number links the device to a specific GSD file that contains a full description of the field device type of the manufacturer. When starting the cyclic communication, the ident number is used to verify whether the devices that are addressed in the bus match the devices that are projected in the GSD file. If not, an error is issued.

This way, devices of different manufacturers with the same function cannot be replaced with each other. In order to enable easy interchangeability (e. g., in case of repair or substitution), devices corresponding to the PROFIBUS PA profile are divided into device classes. Devices in these classes are assigned a profile-specific ident number.

For information on the PROFIBUS ident number, see chapter 3.3.

For information on the PROFIBUS ident number setting in the device type manager, see chapter 10.3/see chapter 10.4.

#### **Other Device Identification Parameters**

In order to identify a specific installed device, several read-only parameters are available. Examples among others are:

- Device ID
- Device serial number
- Software revision
- Hardware revision

For more information on these parameters in the device type manager, see chapter 10.3.1/see chapter 10.4.1.

### 7.2 Device Documentation

#### **Device Documentation Parameters**

Several parameters enable you to store information related to the specific use in the device itself.

Examples among others are:

- Installation date
- Tag description
- Strategy

For more information on these parameters in the device type manager, see chapter 10.3.1/see chapter 10.4.1.

## 8 Channel-Related Parameters for the Valve Coupler Modes

This section describes the channel-related parameters and basic information, regarding the following aspects:

- Setpoint inversion
- Modes of operation
- Functional parameters
- Diagnostic parameters

### 8.1 Use of Setpoint Variables SP\_D and RIN\_D

The setpoint value controls the position of the final control element, for example a valve or a pilot valve if available.

The setpoint value is 0 or 1 (1 byte). The set position may be either "closed" or "open".



**Note!**

**Behavior of the Setpoint Value**

The setpoint value works contrary to a number of conventional devices, where, e. g., the value "0" stands for "valve current OFF" and the value "1" stands for "valve current ON".

Thus, the MIO needs the information if in the "open" valve position the current is ON or OFF for the auxiliary valve. This is specified by the Actuator Fail Action parameter, see chapter 8.3.1.

The Actuator Fail Action parameter determines in which state the valve is OFF. In this context, the Invert Setpoint parameter determines the values for the set position.

If the Invert Setpoint parameter is set to "OFF", the setpoint value is not inverted. The setpoint value "0" controls the valve in the "closed" position. The setpoint value 1 controls the valve in the "open" position.

If the Invert Setpoint parameter is set to "ON", the coding of the setpoint value is inverted. That means, the setpoint value "0" controls the valve in the "open" position. The setpoint value 1 controls the valve in the "closed" position.



**Example!**

**Example 1: "Invert Setpoint" is OFF**

- The Actuator Fail Action parameter is set to "closed".
- The actuator moves into the closed position ("closed"), when the current of the valve is OFF.
- If the setpoint value is "0" ("closed"), the auxiliary valve is not triggered.

=> In this case, "0" means "current OFF".



**Example!**

**Example 2: "Invert Setpoint" is ON**

- The Actuator Fail Action parameter is set to "open".
- The actuator moves into the open position ("open"), when the current of the auxiliary valve is OFF.
- If the setpoint value is "0" ("closed"), the auxiliary valve is triggered.

=> In this case, "0" means "current ON".



**Example!**

**Example 3: "Invert Setpoint" is ON**

- The Actuator Fail Action parameter is set to "closed".
- The actuator moves into the closed position ("closed"), when the current of the auxiliary valve is OFF.
- If the setpoint value is "0" ("open"), the auxiliary valve is triggered.

=> In this case, "0" means "current ON".

## 8.2 Modes of Operation

The Target Mode parameter determines the required mode of operation of the channel.

You can select one of the following modes.

### 8.2.1 Device Maintenance Modes

- **O/S (Out of Service):** In this mode, the channel is out of service. The valve output is disabled so that the valve moves into the mechanical safety position. Use this mode in either of the following cases:
  - Disable an unused channel.
  - Avoid unintended control of the valve during parameterization of a channel. Otherwise the control value of the valve might be unintentionally modified by the Actuator Fail Action or Invert Setpoint parameters.
- **Man (Manual):** In this mode, you can manually control a channel by acyclic data exchange. You can use a configuration tool, e. g., a device type manager, for maintenance and servicing functions.

### 8.2.2 Operating Modes

- **Auto (Automatic):** This is the standard mode of operation (default setting) for cyclic user data exchange. The control system sets the valve setpoint value via the cyclic communication variable SP\_D. In case of a failure, the valve is set to the parameterized fault state position specified by "fail-safe mode".
- **RCas (Remote Cascade):** This is a modified form of the Auto mode. This mode specifies a certain behavior in a failure case. In a failure case, the channel changes over to the Auto mode and returns to RCas only if requested by the master (control system). This way, it is possible to prevent the channel from automatically restarting when the status of the setpoint value changes from GOOD to BAD and back to GOOD.

### 8.2.3 Operating Mode "Auto" in Case of Fault

If the device is in the Auto mode, the setpoint value is specified via the variable SP\_D, as long as the related state is "good (NC)-OK". If the status changes to BAD, the valve is set to the fault state position after a time, as defined in the Fail-Safe Time parameter.

If the fail-safe state is active, a bit is set in the variable CB\_D.

The Fail-Safe Time parameter indicates the time interval, in seconds, between the occurrence of the fault and the control of the valve into fault state position. The fault state position is determined by the Fail-Safe Mode parameter.

The following fail-safe modes are selectable:

- Mode "Keep the last position": last valid setpoint value.
- Mode "Move into the mechanical safety position", specified by Actuator Fail Action parameter. The mechanical fail-safe position is always reached by switching the valve off.
- Mode "Set position" specified by "fail-safe default value". The "fail-safe default value" can be set to OPEN or CLOSED.

Conditions when the fail-safe handling is stipulated:

- Status change to "GOOD (NC)-IFS" status. The fail-safe time is not awaited. The safe position is approached immediately.
- The status of the specified setpoint value is BAD. If communication is aborted with the DP watchdog activated, the status automatically changes to BAD.
- The device is switched ON. The fault state position is left, as soon as the conditions for approaching the fault state position have ceased to exist. This is the case if the control system has reset the status of the specified setpoint value to "GOOD (NC)-OK".

## 8.2.4 Operating Mode "Remote-Cascade (RCas)"

The RCas mode is used to prevent the channel from automatically restarting when switching ON the device or when the status of the setpoint value has become BAD. The setpoint value is specified via the variable RIN\_D.

In the Auto mode, a valve connected to the valve coupler leaves the fault state position and follows the setpoint value, as soon as the condition for approaching the fault state position has ceased to exist.

In the RCas mode, the channel can change to another than the specified operating mode. This state is called "actual mode". If the status of the setpoint value RIN\_D is BAD for a longer period than the "fail-safe time", the actual mode changes to Auto. In this case, the channel behaves as described in see chapter 8.2.3.

Thus, an alternative setpoint value specification via SP\_D can take place if the status of SP\_D is "GOOD (NC)-OK". If the status of SP\_D is BAD, the valve is set to the fault state position. In this case, it is not necessary to wait for the fail-safe time again.

Changing back into the RCas operating mode takes place only after a handshake via the status values of RIN\_D and ROUT\_D.

When changing the actual operating mode to Auto, the status of ROUT\_D changes to "GOOD (C)-IR" at the same time, in order to indicate that the actual mode does not correspond to the target mode.

The status "GOOD (C)-IR" of ROUT\_D must be acknowledged by the status "GOOD (C)-IA" to RIN\_D. Next, the channel changes over back to RCas and the status of ROUT\_D is set to "GOOD (C)-OK".

In case of abortion and restart of communication, the also set the status of RIN\_D to "GOOD (C)-OK". This prevents the channel to change over immediately to RCas via the status "GOOD (C)-IA".

## 8.3 Functional Parameters

This section describes the channel-related functional parameters.

### 8.3.1 Actuator Fail Action

The Actuator Fail Action parameter defines the fail-safe handling of the valve.

The following values can be selected:

- Open, valve is self-opening when not activated.
- Close, valve is self-closing when not activated.

Ensure that you take the entire signal chain into account, e. g., including a pilot valve and the final control element.

If the initialization run is used, setting this parameter is not required.

For more information on the initialization run, see chapter 6.4 and in the DTM, see chapter 10.4.6.

### 8.3.2 Sensor Usage

Whether an actuated sensor or an actuated mechanical contact represents an open or closed valve position, depends on the design of the position feedback.

Therefore, the Sensor Usage parameters offer the following modes for configuring the MIO device according to the individual requirements:

SENSOR_USAGE Value	Sensor A	Sensor B	Valve Position
2	0	1	CLOSED
	0	0	INTERMEDIATE
	1	0	OPEN
	1	1	UNDEFINED
3	1	0	CLOSED
	1	1	INTERMEDIATE
	0	1	OPEN
	0	0	UNDEFINED
4	1	0	CLOSED
	0	0	INTERMEDIATE
	0	1	OPEN
	1	1	UNDEFINED
5	0	1	CLOSED
	1	1	INTERMEDIATE
	1	0	OPEN
	0	0	UNDEFINED
7	No position detection		

The signals of the position feedback sensors are defined as follows:

- Sensor current high -> logical 1
- Sensor current low -> logical 0

## 8.4 Diagnostic Parameters

This section describes the channel-related diagnostic parameters.

### 8.4.1 Wire Check

You can activate or deactivate the monitoring of wire faults. The following parameters exist:

Parameter	Description
VALVE_WIRE_CHECK	Enables/disables the lead short circuit and lead breakage monitoring of the valve connection for the hardware channels 1, 4, 7, 10 (transducer-block-specific)
SENSOR_A_WIRE_CHECK	Enables/disables the lead short circuit and lead breakage monitoring of the position feedback sensor A connection for the hardware channels 2, 5, 8, 11 (transducer-block-specific)
SENSOR_B_WIRE_CHECK	Enables/disables the lead short circuit and lead breakage monitoring of the position feedback sensor B connection for the hardware channels 3, 6, 9, 12 (transducer-block-specific)

For all parameters, bit 0 enables/disables the lead short circuit monitoring and bit 1 enables/disables the lead breakage monitoring:

0 = disabled

1 = enabled

### 8.4.2 Stroke Counter

The MIO can monitor the number of strokes of a valve. A stroke starts in the valve status "open" and continues with a closing and opening procedure. The stroke counter thus increases by 1, after the valve is closed and opened again.

The number of strokes can be compared with a freely adjustable limit value. If this limit value is exceeded a message is issued. To activate the stroke monitoring process, change the Valve Monitor parameter to either of the following values: "stroke counter" or "time monitor and stroke counter".

In addition, activate monitoring of the valve setting times for "time monitor and stroke counter". For more information, see chapter 8.4.3 and in the DTM, see chapter 8.4.3. The current counter reading is included in the Stroke Counter parameter. You can also change this parameter to a specified value if the valve, e. g., was in operation before.

Enter the limit value in the Limit Stroke Counter parameter. When this limit value is exceeded, the message "limit stroke counter exceeded" is issued. For bit 16 in CB\_D, see chapter 4.3.1.

If you set the Sensor Usage parameter to "no position check", the stroke counter monitoring is not activated. For more information, see chapter 8.3.2 and in the DTM "Sensor usage", see chapter 10.4.6.

### 8.4.3 Time Monitoring

The MIO device can monitor the breakaway and transit times of a valve. The Valve Monitor parameter is either set to "time monitor" or "time monitor and stroke counter". In addition, you can activate the stroke counter for "time monitor and stroke counter". For more information, see chapter 8.4.2 and in the DTM, see chapter 10.4.7.

Define a reference value and a tolerance value for the breakaway and transit times.

The tolerance value is used to avoid fault messages due to normal variations of the process and ambient conditions.

The breakaway and transit times are monitored during the opening and closing process.

If the measured time is longer or shorter than the reference value plus a tolerance, the MIO device indicates an exceeding time. The MIO indicates the blocking of the valve if the new final position is not reached after the 5 x time of the breakaway time plus transit time.



**Note!**

**Tolerance Value**

**The tolerance of the time monitoring is 40 ms.**

For the definition of the breakaway and transit times refer to the figure below. The feedbacks of the position sensors are given both for the Sensor Usage parameter setting "low active " and "high active",

**Definition of Breakaway and Transit Times**

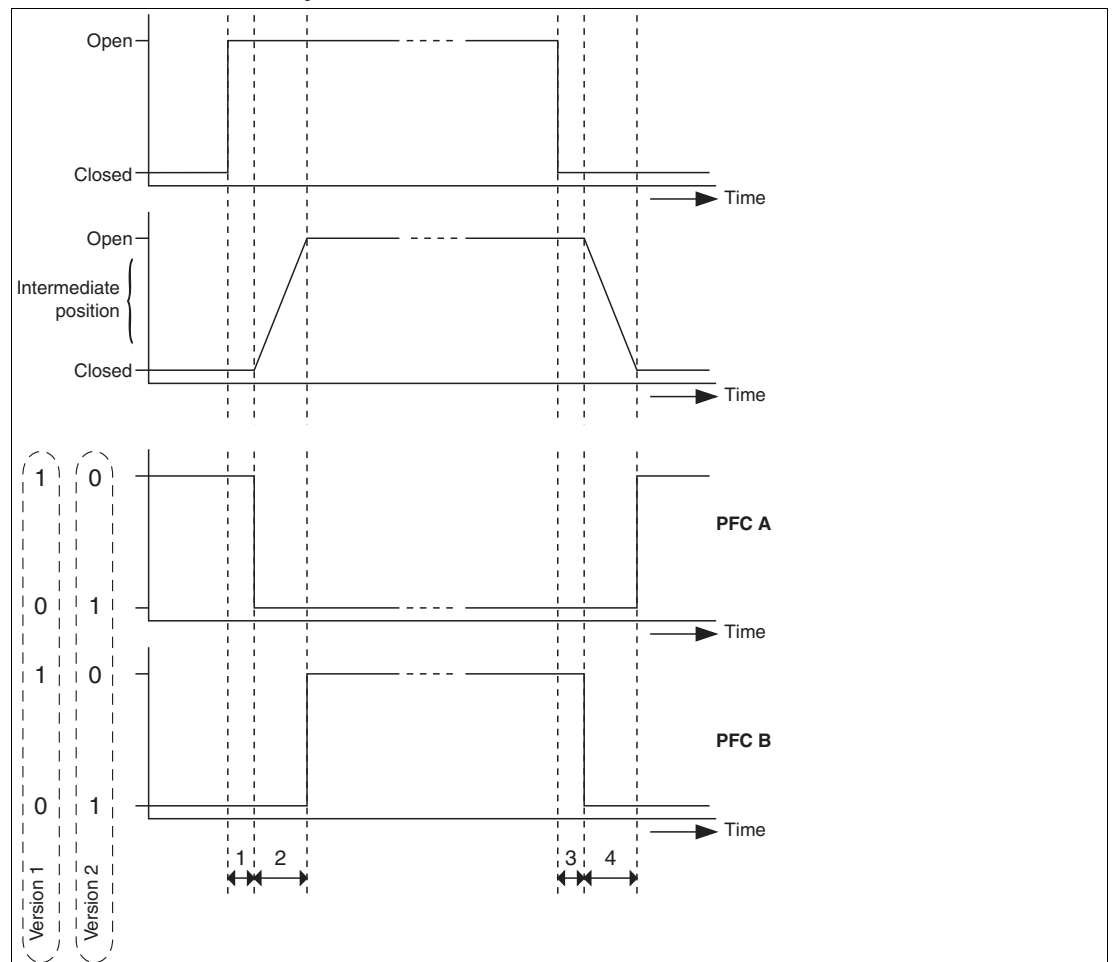

- 1 = breakaway time closed->open
- 2 = transit time closed->open
- 3 = breakaway time open->closed
- 4 = transit time open->closed

#### 8.4.4 Cyclic Function Test (Partial Stroke Test)

You can activate a cyclic function test for each channel. Use this function test, e. g., if you need to regularly monitor a valve for correct functioning that is hardly triggered.

The factory setting of the Cyclic Function Test parameter is "OFF". Set the parameter to "ON". Go to the Period of Cyclic Function Test parameter in order to specify the intervals during which to carry out the test.

After the specified time interval elapsed, the valve is controlled – for a short period – into the position opposite to the current position, until the relevant final position sensor indicates the breakaway of the valve. Next, the valve is controlled back immediately. That means, the test does not interfere with any process that is running in the meantime.

This procedure is repeated periodically.

Valve time monitoring remains active during the tests. The indication that the breakaway time, measured during the test, is exceeded or fallen below, is given via the CB\_D variable. The CB\_D variable also detects and indicates that the valve is blocked. For more information on the variable, see chapter 4.3.1.



## 9 Channel-Related Parameters for the Sensor Input Modes

This section describes the channel-related parameters of the sensor input modes: binary input, frequency input, and counter. The following parameters are described:

- Modes of operation
- Diagnostic parameters
- Functional parameters

### 9.1 Modes of Operation

The Target Mode parameter determines the required mode of operation of the channel.

You can select one of the following modes.

#### 9.1.1 Device Maintenance Modes

- **O/S (Out of Service):** In this mode, the channel is out of service. The sensor output is disabled.
- **Man (Manual):** In this mode, you can manually control a channel by acyclic data exchange. You can use a configuration tool, e. g., a device type manager, for maintenance and servicing functions.

#### 9.1.2 Operating Modes

- **Auto (Automatic):** This is the standard mode of operation (default setting) for cyclic user data exchange. In case of a failure, the binary or frequency input uses a predefined fail-safe behavior as a fallback.

#### 9.1.3 Operating Mode "Auto" in Case of Fault

The device is in the Auto mode as long as the related state is "GOOD (NC)-OK". If the status changes to BAD, a predefined fail-safe behavior takes place.

For the sensor input types binary input and frequency input, the following fail-safe behaviors are selectable:

- Mode "Keep (wrong calculated) OUT value": Keeps the last OUT value that was calculated - even if it was wrong.
- Mode "Use fail-safe value as OUT": The fail-safe value is the default value for the OUT parameter if a sensor or sensor electronics are detected.
- Mode "Use last valid OUT value": Device falls back onto the last valid OUT value.

### 9.2 Functional Parameters

This section describes the channel-related functional parameters.

#### 9.2.1 Sensor Mode

You can enable/disable the sensing of inputs, in order to shorten the total update time of the sensor inputs. The following parameters exist:

Parameter	Description
SENSOR_MODE	Enables/disables hardware channels 1, 4, 7, 10 (transducer-block-specific)
SENSOR_A_MODE	Enables/disables hardware channels 2, 5, 8, 11 (transducer-block-specific)
SENSOR_B_MODE	Enables/disables hardware channels 3, 6, 9, 12 (transducer-block-specific)

The following modes are available:

- 1: Sensor input enabled
- 0: Sensor input disabled

In frequency or counter mode, the channels 4, 7, and 10 are disabled.

## 9.2.2 Sensor-On Time

The Sensor-On Time parameter defines the time (in 10 ms ... 11000 ms) the input is turned ON to determine the sensor input state. The parameter is valid for the sensor inputs 1, 4, 7, and 10.

In the frequency or counter mode, the sensor input 1 is turned on constantly and the sensor inputs 4, 7, and 10 are turned off.

## 9.3 Diagnostic Parameters

This section describes the channel-related diagnostic parameters.

### 9.3.1 Sensor Wire Check

You can activate or deactivate the monitoring of wire faults. The following parameters exist:

Parameter	Description
SENSOR_WIRE_CHECK	Enables/disables the lead short circuit and lead breakage monitoring of the sensor connection for the hardware channels 1, 4, 7, 10 (transducer-block-specific)
SENSOR_A_WIRE_CHECK	Enables/disables the lead short circuit and lead breakage monitoring of the position feedback sensor A connection for the hardware channels 2, 5, 8, 11 (transducer-block-specific)
SENSOR_B_WIRE_CHECK	Enables/disables the lead short circuit and lead breakage monitoring of the position feedback sensor B connection for the hardware channels 3, 6, 9, 12 (transducer-block-specific)

The following monitoring modes are available:

- Bit 0: Short circuit monitoring:
  - 0: channel disabled
  - 1: channel enabled
- Bit 1: Lead breakage monitoring:
  - 0: channel disabled
  - 1: channel enabled

## 10 PACTware Multi-Input/Output Device Type Manager

### 10.1 DTM Software Installation and Commissioning

For details on the system requirements for installation, commissioning, and operation of the software, refer to the release notes of the DTM. The release notes are available on the Internet under [www.pepperl-fuchs.com](http://www.pepperl-fuchs.com).



#### Installing the DTM Package with the FDT Frame Application PACTware™ (Example)

To install the DTM package on your system, proceed as follows:

1. Install the Pepperl+Fuchs FieldConnex DTM package. For more information, refer to the Readme file in the FieldConnex® DTM Collection.
2. Start the PACTware™ program.  
Make sure that all PACTware™ projects are closed.
3. To open the Device Catalog, press **F3**.
4. To update the device catalog click on the button **Update device catalog**.  
↳ The following request appears: Create new PACTware device catalog.
5. Confirm the question with **Yes**.  
↳ The DTM is installed and ready for operation.



#### Creating a Project

To create the project, proceed as follows:

1. Start PACTware™.  
Make sure the latest DTM version is installed and that the device catalog is updated.
2. To open or create a project, select:  
**File > Open** or  
**File > New**.
3. Open the device catalog:  
**View > Device Catalog** or press **F3**.
4. Open the respective "Vendor" menu item.
5. Choose **Driver >** and the respective PROFIBUS communication DTM.
6. In the project window go to: Host PC. Drag and drop the PROFIBUS communication DTM driver underneath it.  
Example: PROFIdtm or, in case you use a gateway, the PNIO CommDTM.
7. In the device catalog, open the "Vendor" menu item **Pepperl+Fuchs GmbH**.
8. Option in case you use a gateway: Choose, e. g., **Gateway > HD2-GTR-4PA.PN** and drag and drop this DTM underneath Host PC into your project window.
9. Choose **Device > \*D0-MIO-Ex12.PA.\***.

10. Drag and drop the DTM \*D0-MIO-Ex12.PA.\* to your project window under the PROFIBUS COM DTM driver.

↳ Your project should now look like this:



Figure 10.1 DTM project

## 10.2 Device Type Manager (DTM) Dialogs

The device type manager (DTM) \*D0-MIO-Ex12.PA.\* features the following dialogs to parameterize and monitor the multi-input/output (MIO) device:

- Parameterization
- Online parameterization
- Measured value
- Simulation
- Diagnosis

### Parameterization Process of the DTM

The following flowchart shows how parameterization is organized, when using the DTM.

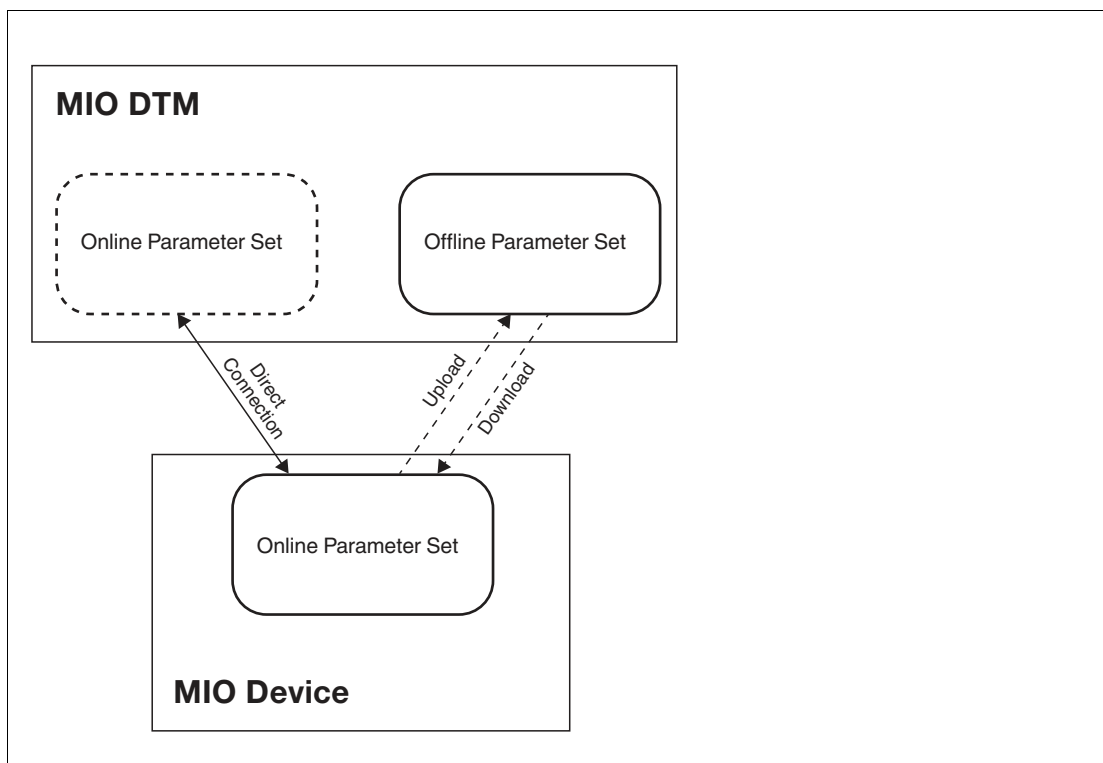

Figure 10.2 Parameterization flowchart

2018-07

### Load from Device

Settings made in the online parameter set are not automatically transferred to the offline parameter set.

The function **Load from Device** is used to upload data from the device into the offline parameter set.



#### Loading from Device

1. In order to open the context menu, right-click in the project on \*D0-MIO-Ex12.PA.\*
2. Select **Load from Device**.

### Store to Device

If a device is replaced with a new device, the parameters that were used last can be downloaded to the device.

The function **Store to Device** is used to download parameters from the DTM to the device.



#### Storing to Device

1. To open the context menu, right-click in the project on \*D0-MIO-Ex12.PA.\*
2. Select **Store to Device**.

## 10.2.1 Online Dialogs

Online dialogs show the currently set parameters stored on the device.

### Connect to the Device

In order to use the online dialogs, you need to connect to the device first.



#### Connecting the \*D0-MIO-Ex12.PA.\* DTM with the Device

Make sure all settings are correct, e. g., the device address, etc.

1. In order to open the context menu, right-click in the project on \*D0-MIO-Ex12.PA.\*
2. Select **Connect**.

↳ The **Plug** icon in the menu bar indicates that device is connected, i. e., online.

### Online Parameterization

Setting parameters in the online dialog directly affects device parameters. Entries or changes are immediately written to the device, when affirmed with the **Apply** button.



#### Opening the Online Parameterization Dialog

1. In order to open the context menu, right-click in the project on \*D0-MIO-Ex12.PA.\*
2. Select **Parameter > Online Parameterization**.

### Measured Value

The dialog issues a list of the currently measured values at any time.



### Opening the Measured Value Dialog

1. In order to open the context menu, right-click in the project on \*D0-MIO-Ex12.PA.\*
2. Select **Measured Value**.

### Simulation

The dialog can be used to simulate parameter settings for the device in use or manually set OUT value and status for the device.

This way, you can validate settings for your application, before using them in live operation. In the course of commissioning you can check what parameters are required to achieve specific OUT values. You can also use the manual OUT value setting to force an OUT value, e. g., in case of a sensor failure.



### Opening the Simulation Dialog

1. In order to open the context menu, right-click in the project on \*D0-MIO-Ex12.PA.\*
2. Select **Simulation**.

### Diagnosis

The dialog offers a current overall summary of the diagnostic state of the device and each channel.



### Opening the Diagnosis Dialog

1. In order to open the context menu, right-click in the project on \*D0-MIO-Ex12.PA.\*
2. Select **Diagnosis**.

## 10.2.2

### Offline Dialogs

The offline dialogs show the parameters currently stored in the DTM parameter set of the FDT project.

### Offline Parameterization

Setting parameters locally in the offline dialog does not directly affect communication or the device. Once all settings are made, data can be written to the device. Current parameters can also be read in from the device, processed, and saved.



### Opening the Offline Parameterization

1. In order to open the context menu, right-click in the project on \*D0-MIO-Ex12.PA.\*
2. Select **Parameter > Parameterization**.

### Print

This offline dialog is a summary report that contains all offline parameter settings.



### Printing Offline Information

1. In order to open the context menu, right-click in the project on \*D0-MIO-Ex12.PA.\*
2. Select **Print**.
3. In the footer of the print preview window click **Print**.
  - ↳ The printer selection menu appears.
4. Select your printer and confirm the print job.

### 10.2.3 Multi-Input/Output Device Type Manager User Interface

The device type manager (DTM) user interface looks like this:

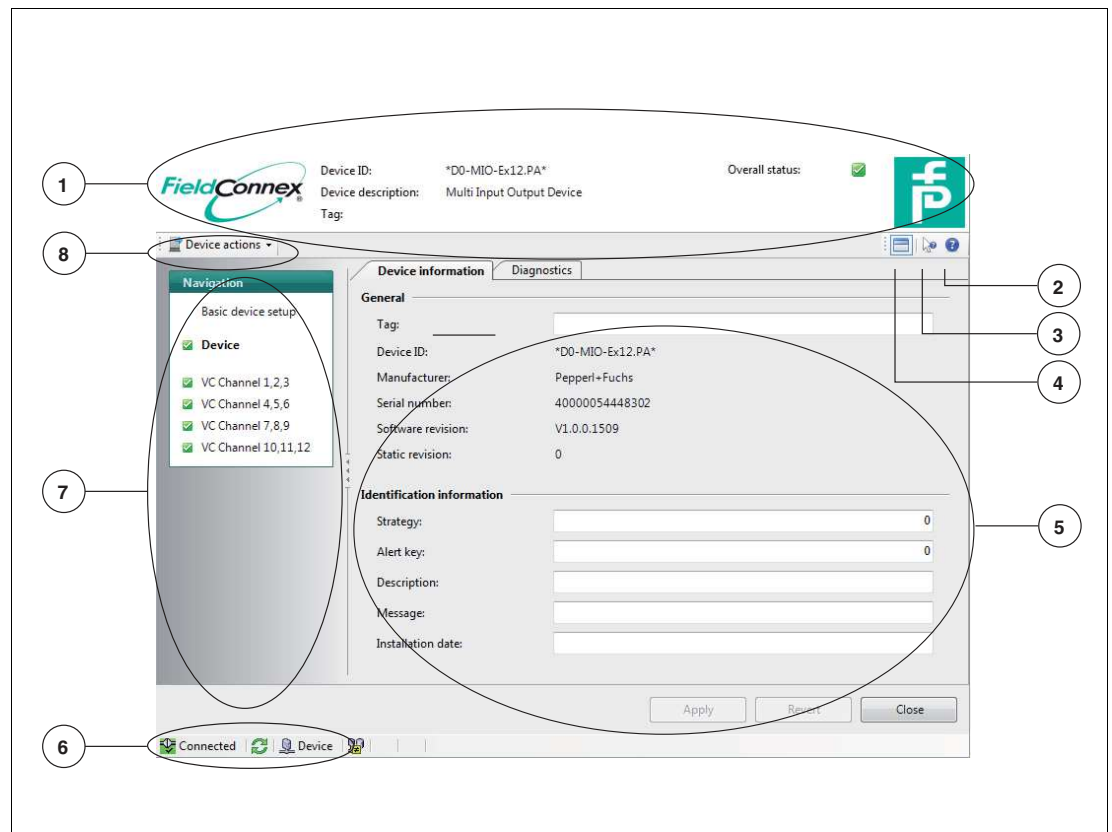

- 1 Top-level identification section: Displays device ID, device description, device tag, and the overall diagnostic status (in online mode) symbolized by NAMUR NE 107 symbols.
- 2 Question mark symbol: Access to the help file
- 3 Combined mouse arrow and question mark symbol: Click on symbol and then on the section where you need help to view help information.
- 4 Top-level section windows symbol: Click to toggle the visibility of the top-level identification section.
- 5 DTM parameterization section: Section offers different tabs and settings for your device.
- 6 PACTware icons to inform whether the device is connect or whether there is an error.
- 7 Left navigation bar: Offers access to the configuration and parameterization views of the device.
- 8 Quick access pull-down menu for the most important online device actions:
  - Activate write lock
  - Restart device
  - Reset bus address
  - Reset factory default settings



## 10.2.4 MIO DTM for Sensor Input Mode - Structural Diagram

The following diagrams show all device-specific and channel-specific parameters the DTM offers for parameterization.

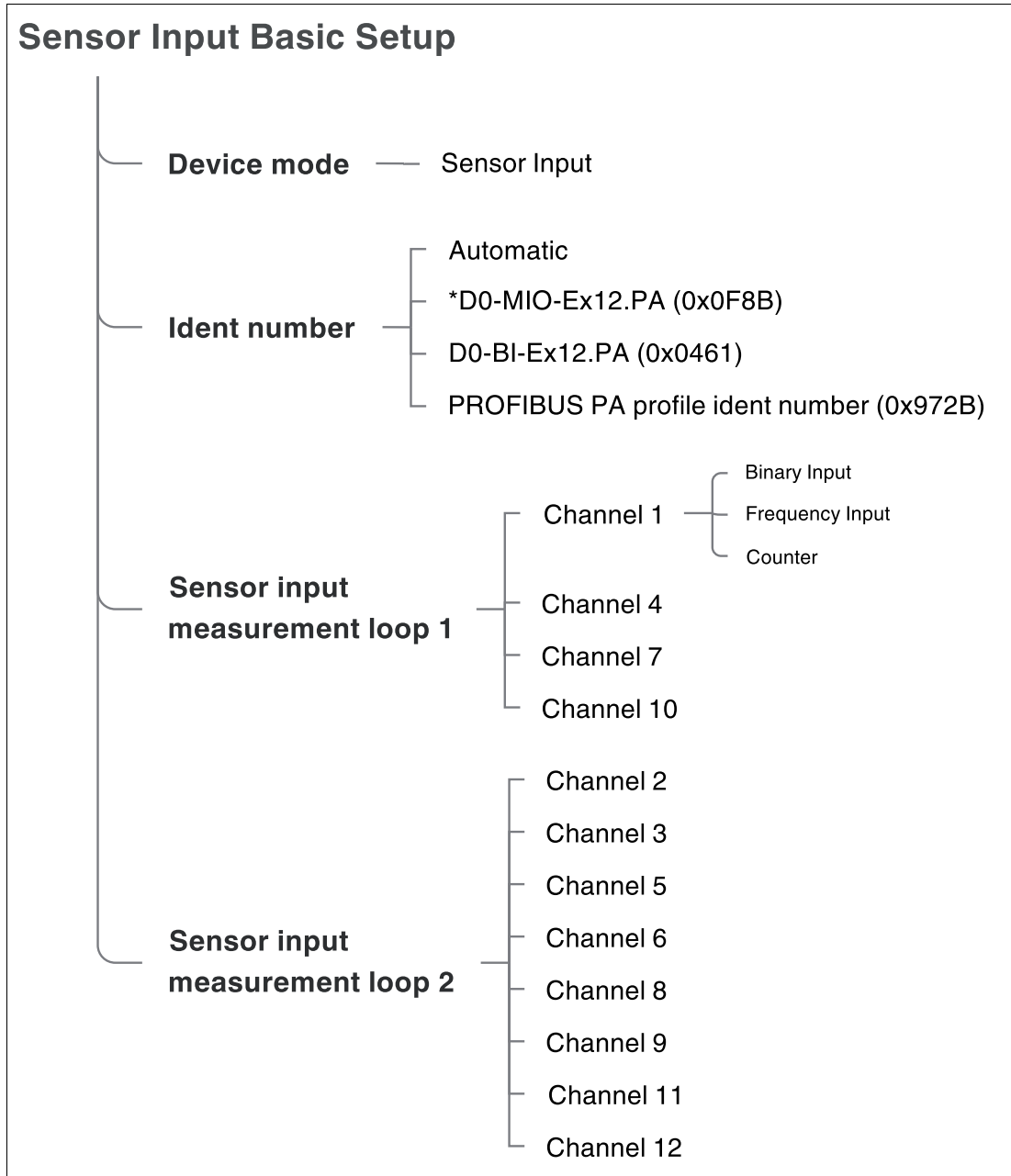

Figure 10.3 Basic setup wizard of the MIO DTM as sensor input



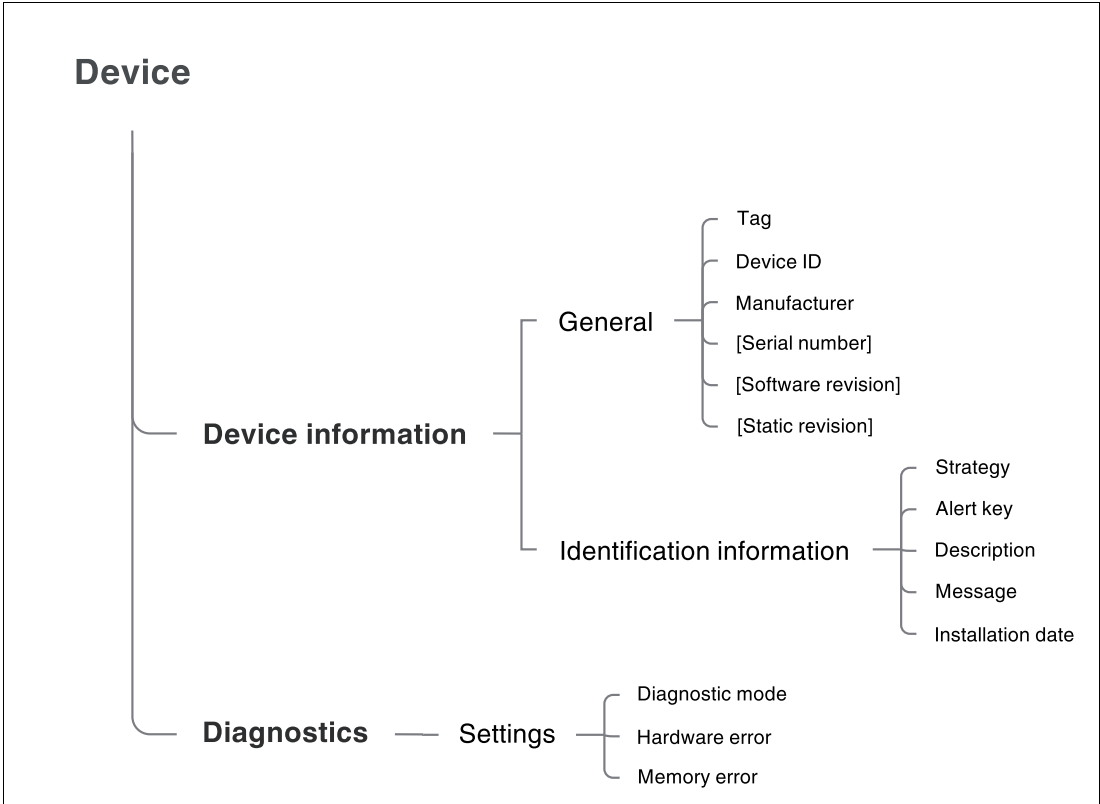

Figure 10.4 DTM menu structure: Device-specific  
Parameters in square brackets [ ]: Online parameters only.

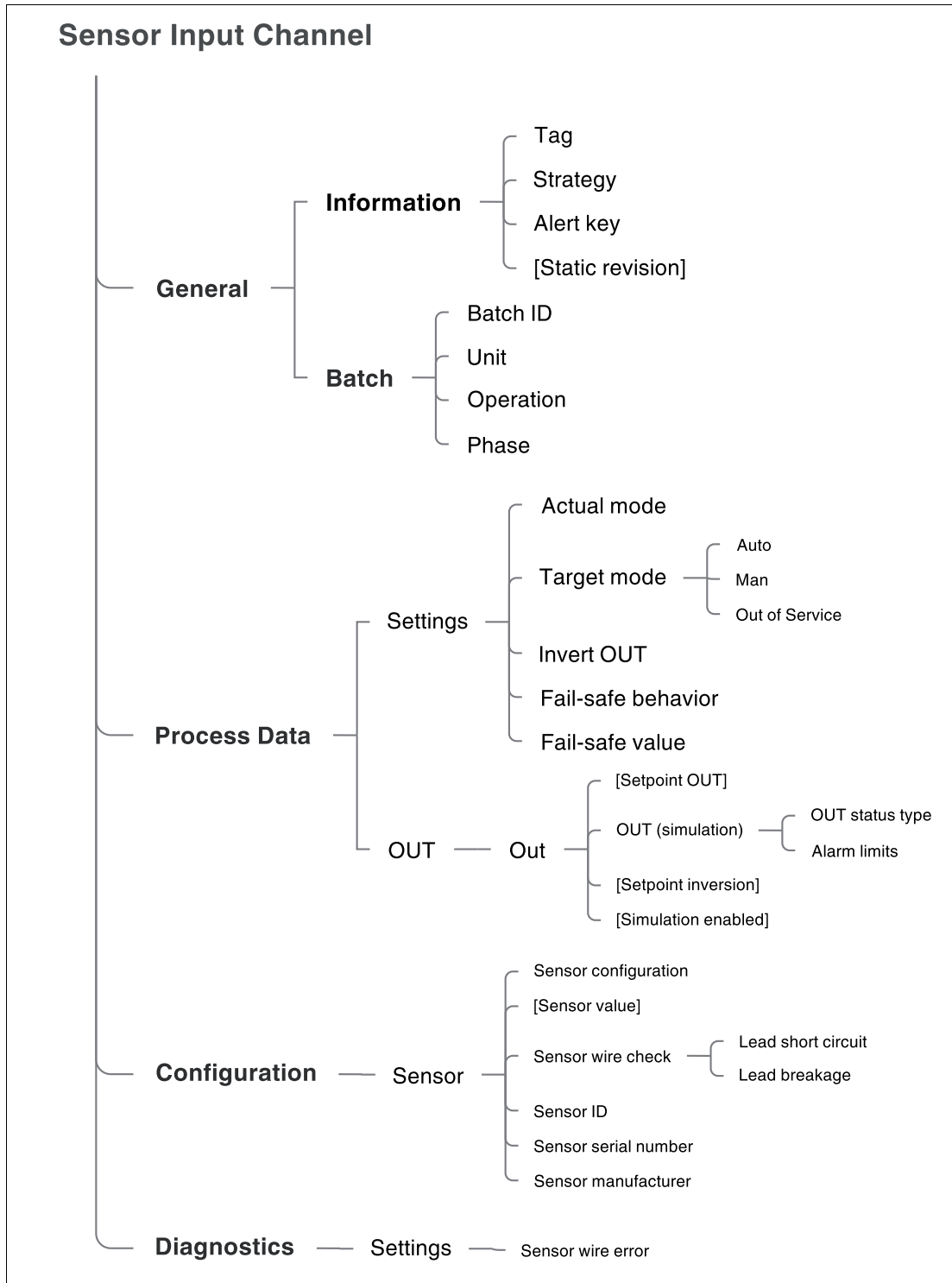

Figure 10.5 DTM for sensor input mode menu structure: Channel-specific Parameters in square brackets [ ]: Online parameters only.



### 10.2.5 MIO DTM for Valve Coupler Mode - Structural Diagram

The following diagrams show all device-specific and channel-specific parameters the DTM offers for parameterization.

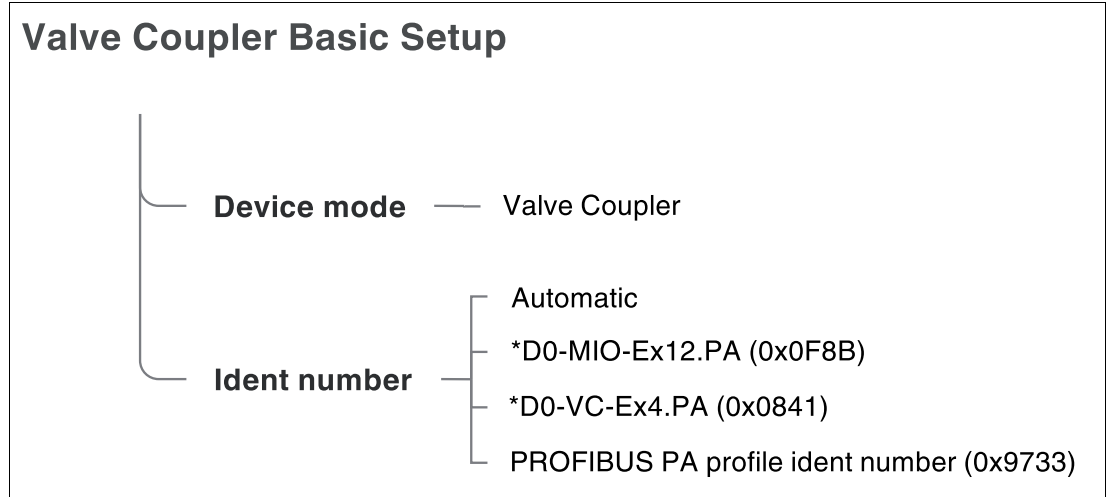

Figure 10.6 Basic setup wizard of the MIO DTM as valve coupler

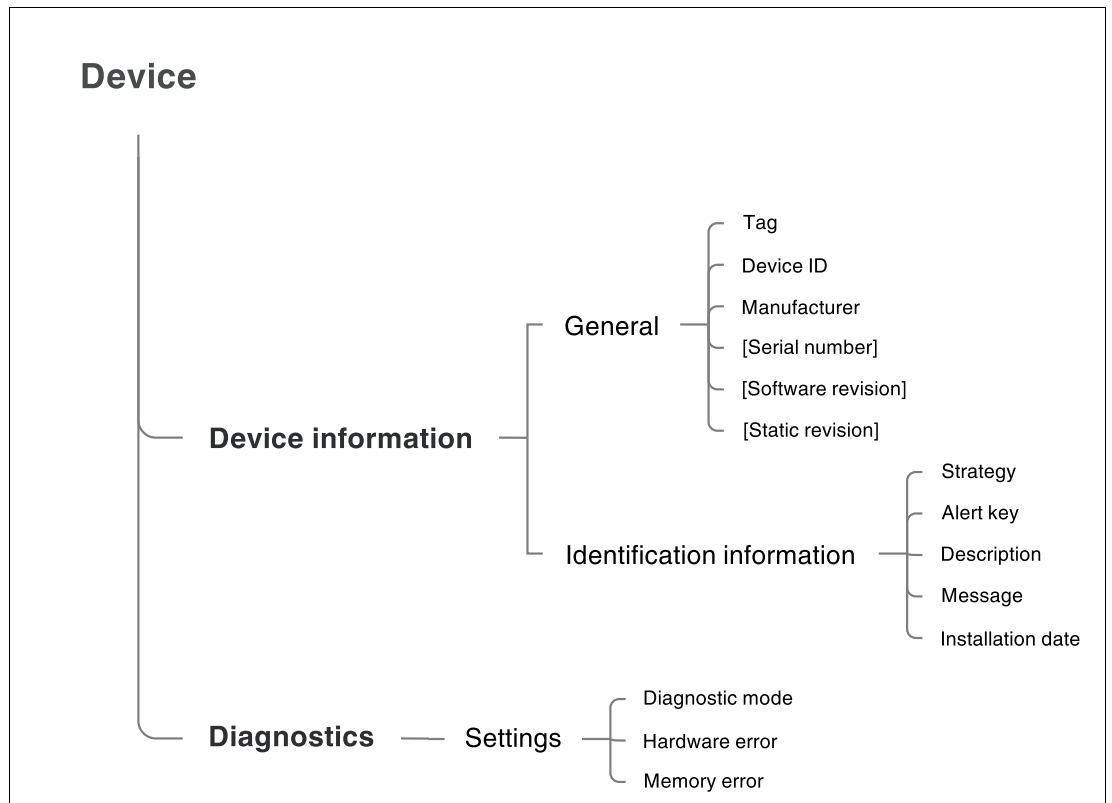

Figure 10.7 DTM menu structure: Device-specific  
Parameters in square brackets [ ]: Online parameters only.

2018-07

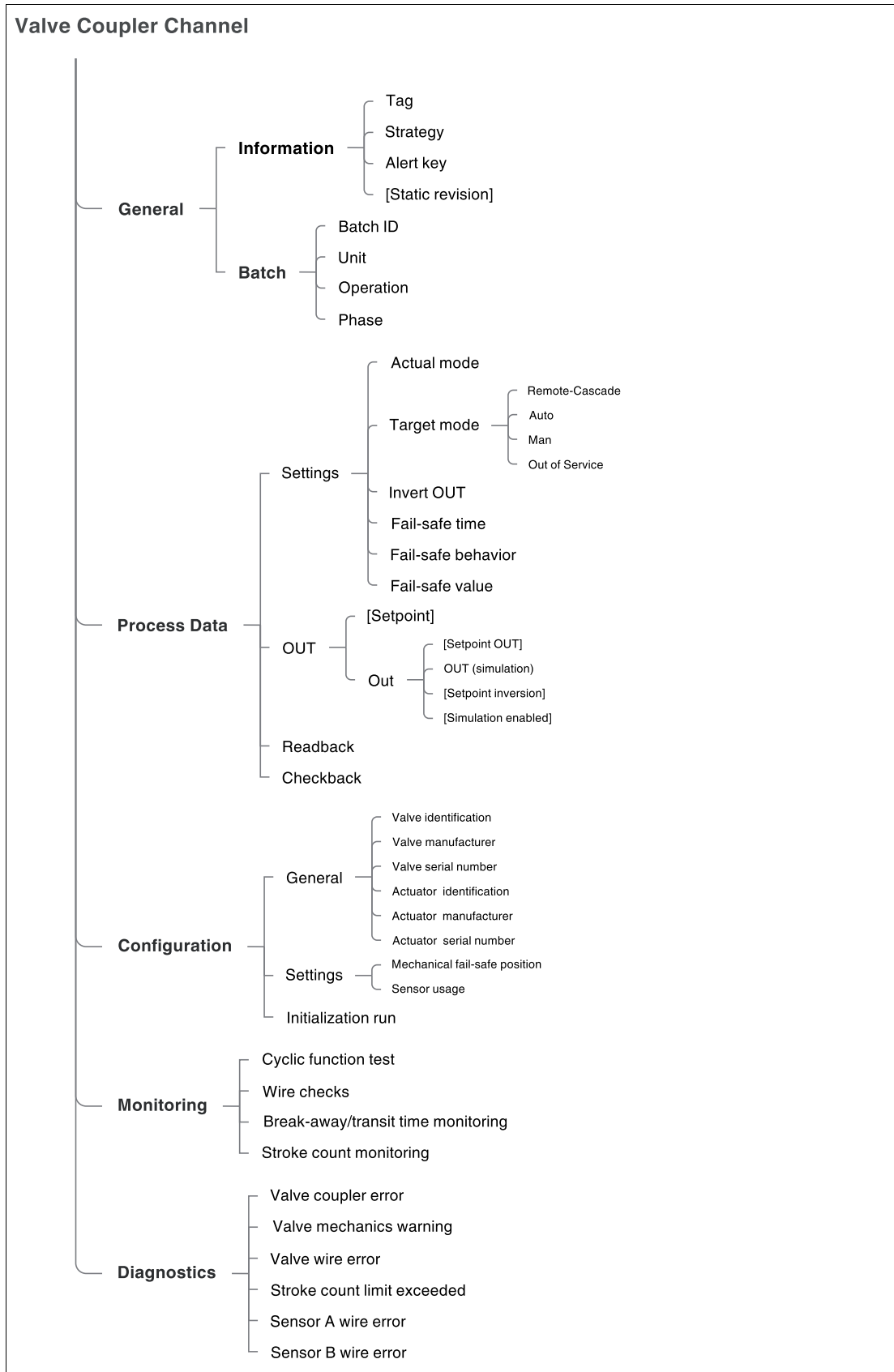

Figure 10.8 DTM for valve coupler mode menu structure: Channel-specific Parameters in square brackets [ ]: Online parameters only.

2018-07

### 10.3 Basic Device Setup in Sensor Input Mode

The “Basic device setup” is the initial setting you must make before going into any further device setup or channel parameterization. In this section you set the MIO device up as a sensor input. Depending on the settings you made, the subsequent menus change accordingly.

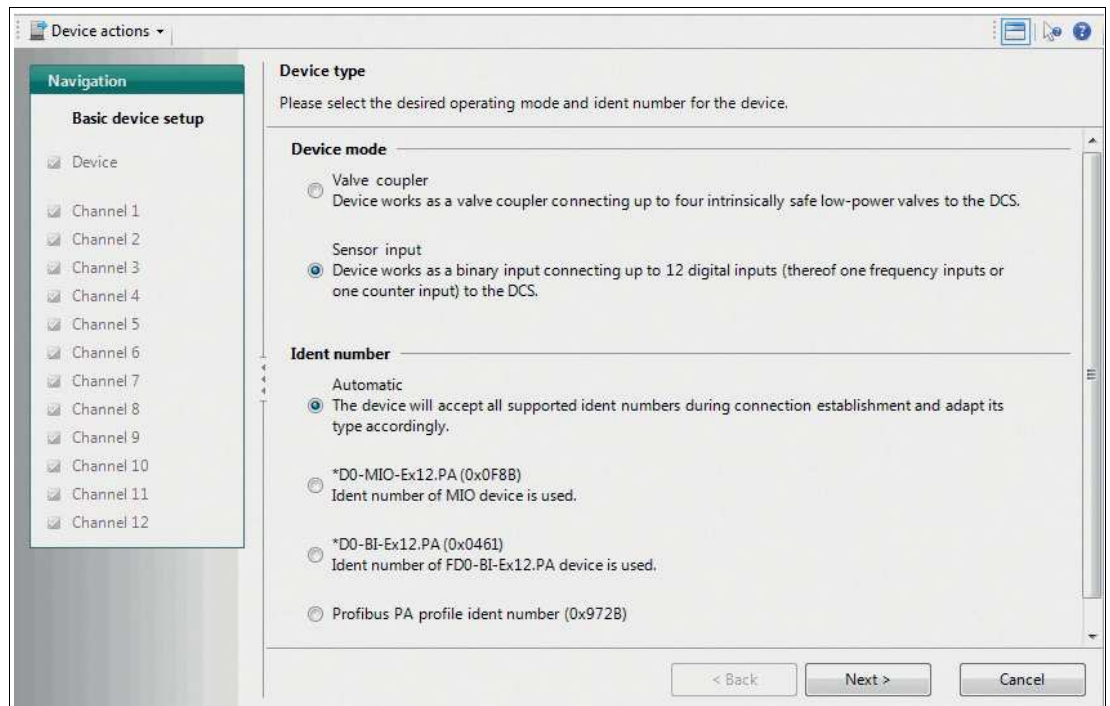

Figure 10.9 Channel "Basic Setup" tab: Select the device type

#### Section "Device mode":

Select the required device mode with the radio button.

#### More Information

For more information on the device modes, see chapter 2.2.

#### Section "Ident number":

Select the required ident number with the radio button.



#### Note!

#### Changing the PROFIBUS Ident Number in the Online Mode

If you use the menu command in online parameterization, a change of ident number selection takes immediate effect. The device is automatically rebooted with the ident number selected.

#### More Information

For more information on ident numbers, see chapter 3.3.

### Setting Up the MIO Device as a Sensor Input

1. Activate the Sensor Input mode with the radio button.
2. Set the required ident number with the radio button.
3. Click on **Next** to adjust the channels as required.

### Adjusting the Channels (1): Channel 1 as Binary Input

1. After selecting the sensor input mode, **Next** brings you to the section "Sensor Input – Adjustment of Channels 1, 4, 7, and 10".

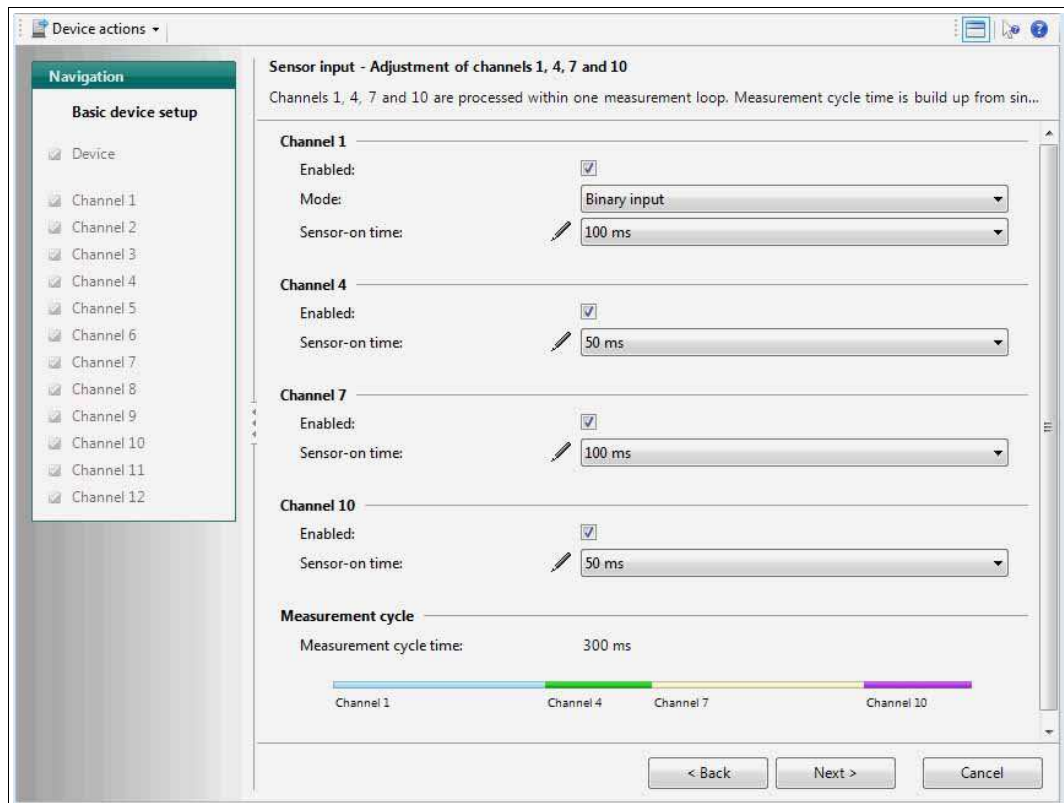

Figure 10.10 Channel "Basic Setup" tab: Adjust channels of the first measurement loop

2. Set channel 1 to "Binary Input" and select the required sensor-on time from the pull-down menu.
3. Enable/disable the channels 4, 7, and 10 as required. For enabled channels you can select a suitable sensor-on time from the corresponding pull-down menu.
4. Click on **Next**. You move to the section "Sensor Input – Adjustment of Channels 2, 3, 5, 6, 8, 9, 11, and 12".

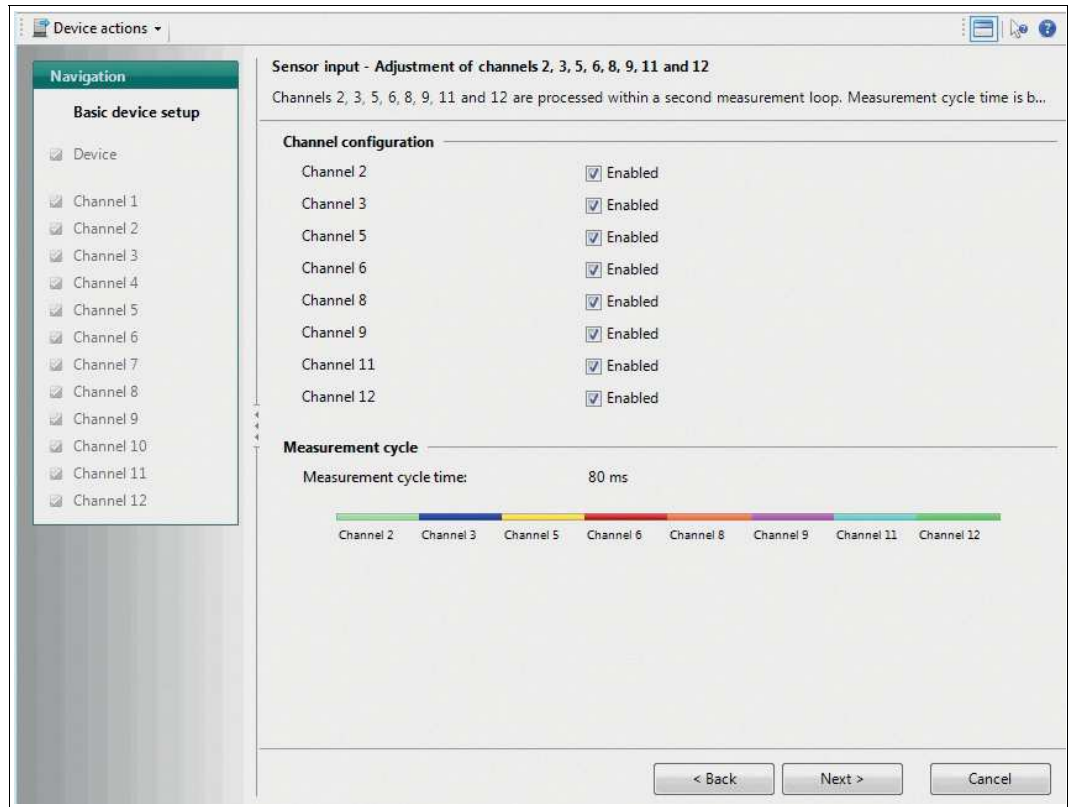

Figure 10.11 Channel "Basic Device Setup" tab: Adjust channels of the second measurement loop

5. Adjust the channels of the second measurement loop as required.
6. Click on **Next**.  
↳ The parameter settings are adjusted for the device and a summarized overview of all the settings made is displayed.
7. Your basic device setup is complete. If you intend to change the settings, click on **Change Configuration** or on **Start** to re-start the basic device setup.



## Adjusting the Channels (2): Channel 1 as Counter or Frequency Input

1. After selecting the sensor input mode, **Next** brings you to the section "Sensor Input – Adjustment of Channels 1, 4, 7, and 10".

**Sensor input - Adjustment of channels 1, 4, 7 and 10**  
Channels 1, 4, 7 and 10 are processed within one measurement loop. Measurement cycle time is build up from single Sensor-on times.

**Channel 1**  
Enabled:   
Mode:   
Sensor-on time:   
*Channels 4, 7 and 10 are disabled as long as channel 1 is used as counter/frequency input.*

**Channel 4**  
Enabled:   
Sensor-on time:

**Channel 7**  
Enabled:   
Sensor-on time:

**Channel 10**  
Enabled:   
Sensor-on time:

**Measurement cycle**  
Measurement cycle time:

Channel 1

< Back    Next >    Cancel

Figure 10.12 Channel "Basic Setup" tab set to Counter: Adjust channels of the first measurement loop

2. Set channel 1 to "Counter" or to "Frequency Input".  
↳ The sensor-on time is automatically set to "Constantly on" and the channels 4, 7, and 10 are disabled.
3. Click on **Next**. You move to the section "Sensor Input – Adjustment of Channels 2, 3, 5, 6, 8, 9, 11, and 12".



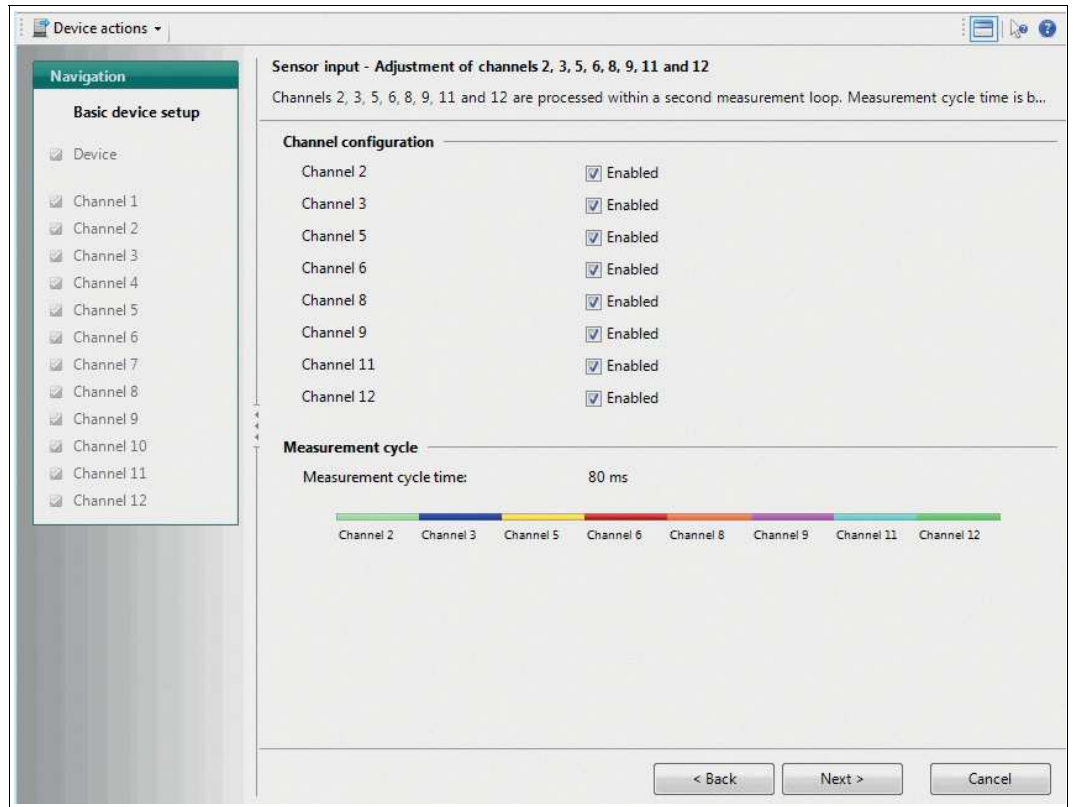

Figure 10.13 Channel "Basic Device Setup" tab: Adjust channels of the second measurement loop

4. Adjust the channels of the second measurement loop as required.
5. Click on **Next**.  
↳ The parameter settings are adjusted for the device and a summarized overview of all the settings made is displayed.
6. Your basic device setup is complete. If you intend to change the settings, click on **Change Configuration** or on **Start** to restart the basic device setup.

#### More Information

For more information on the channel adjustment:

- See chapter 4.4.3
- See chapter 9

### 10.3.1 Tab "Device Information"

This tab enables you to view or change device information as required, including general information on the sensor and identification information needed throughout your process. The settings apply to all sensor input modes.

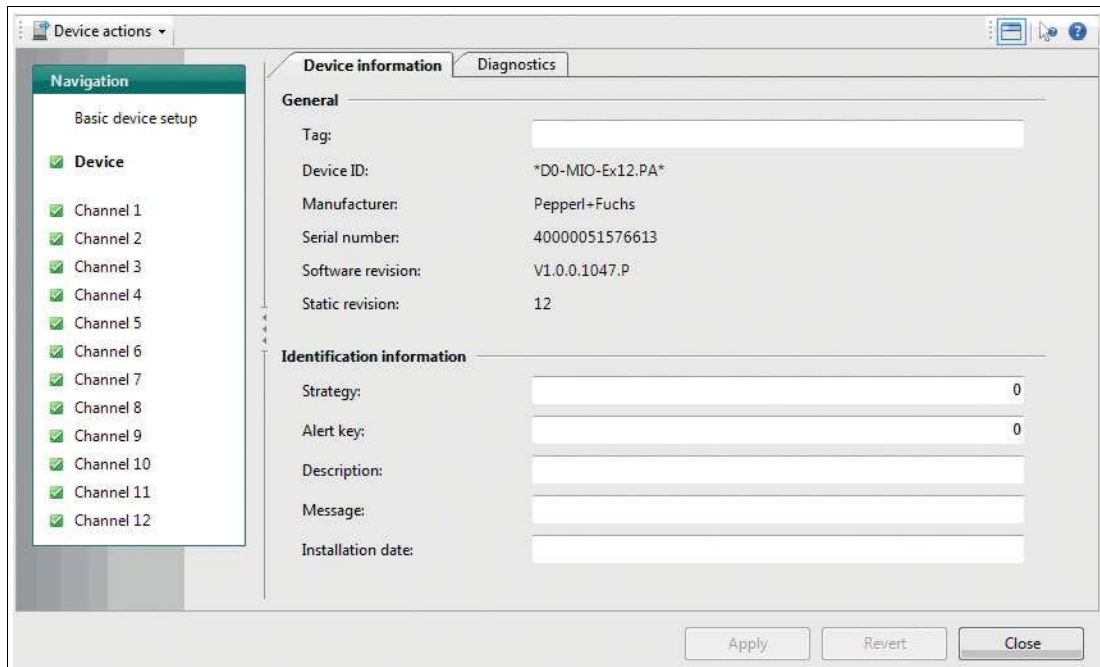

Figure 10.14 "Device Information" tab

The tab "Device Information" contains the following information and parameters:

#### Section "General":

- **Tag:** Free text field, enter a description of the device.
- **Device ID:** Read-only, manufacturer-specific description of the device.
- **Manufacturer:** Pepperl+Fuchs: Read-only, identification of the manufacturer of the device.

#### Information Parameters in the Online Mode

In the online mode, the following read-only information is displayed. Use this data as additional diagnostic information when contacting Pepperl+Fuchs.

- **Serial number:** Serial number of the device
- **Software revision:** Software revision number
- **Static revision:** Incremental modification counter for counting each modification of a parameter to document the status of modification of parameterization. This parameter counts all changes in all device-specific online parameters.

**Section "Identification information":**

- **Strategy:** Free value field, enter value to use for configuration or diagnostics as a code key for sorting or summarizing diagnostic information.
- **Alert key:** Free value field, enter any value for sorting alarms or events that have been generated. The value can contain the identification number of the plant unit. It helps to identify the location (plant unit) of an event.
- **Description:** Free text field, enter any information to describe the device as a measuring point in the application.
- **Message:** Free text field, enter any information to describe the device in the application or plant.
- **Installation date:** Free text field, enter the installation date of the device in the plant.



**Adjusting the Device Information**

1. Use the different fields to enter the information you require for your process.
2. Click on **Apply**.

**More Information**

For more information on the identification information, see chapter 3.3.

10.3.2 Device Tab "Diagnostics"

In the DTM, the tab "Diagnostics" enables you to configure the diagnostic behavior of the device. The settings apply to all sensor input modes.

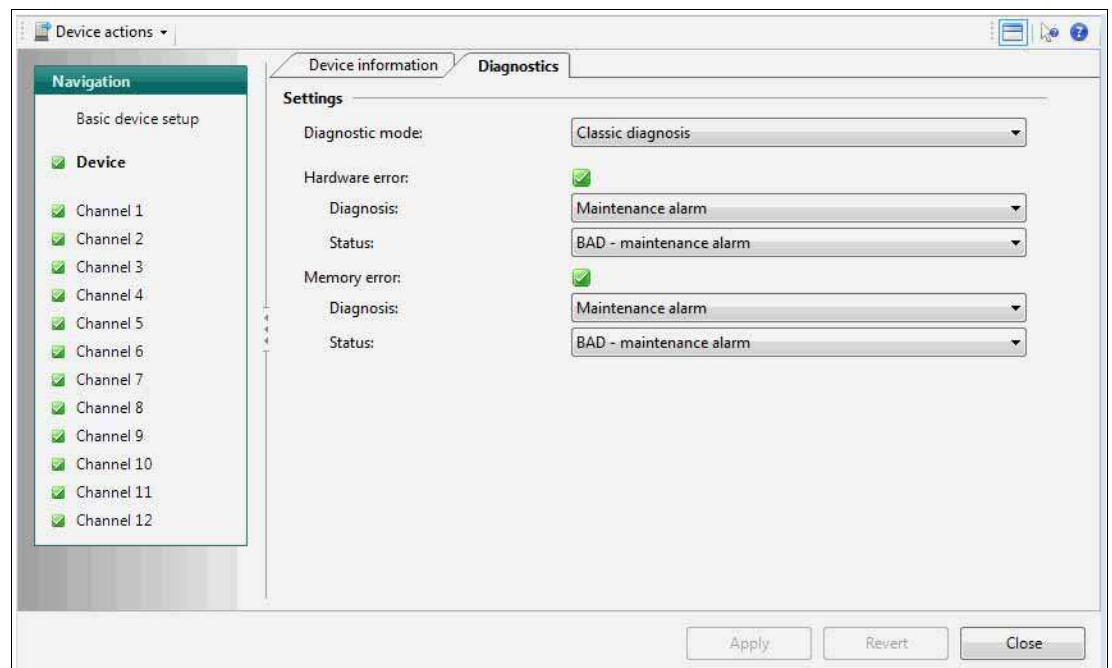

Figure 10.15 Device "Diagnostics" tab



The tab "Diagnostics" contains the following parameters:

**Section "Settings":**

- **Diagnostic mode:** Mode selector to be configured for status and diagnostic behavior. Keep "Condensed diagnosis" or select "Classic diagnosis".
- **Hardware error:** Type of diagnostic message and the mapping with the status this message implies.
- **Memory error:** Type of diagnostic message and the mapping with the status this message implies.



**Note!**

**Diagnostic Type for Cyclic Communication**

Setting the diagnostic type to classic or condensed status in the tab Device determines the diagnostic type of the cyclic communication between the device and the DTM.

The following settings determine the reaction of the device on manufacturer-specific diagnostic events. For each error type you can determine how to diagnose it and determine the status that the process value issues in case of the diagnosis:





Error Type	Diagnosis	Status that the process value issues if the assigned diagnosis is active:
<b>Hardware error:</b>	<ul style="list-style-type: none"> <li>■ None</li> </ul>	<ul style="list-style-type: none"> <li>■ GOOD - OK</li> </ul>
<b>Memory error:</b>	<ul style="list-style-type: none"> <li>■ Maintenance</li> <li>■ Maintenance demand</li> <li>■ Maintenance alarm</li> <li>■ Invalid process condition</li> <li>■ Function check</li> </ul>	<ul style="list-style-type: none"> <li>■ GOOD - Maintenance required</li> <li>■ GOOD - Maintenance demanded</li> <li>■ UNCERTAIN - Maintenance demanded</li> <li>■ BAD - Maintenance alarm</li> <li>■ UNCERTAIN - Process-related, no maintenance</li> <li>■ BAD - Process-related, no maintenance</li> <li>■ BAD - Function check/ local override</li> <li>■ GOOD - Function check</li> </ul>

**Diagnostic Parameters in the Online Mode**

Diagnostic information is displayed additionally in the online mode in order to diagnose issues or failures in real-time as they occur. Any diagnostic information issued by the DTM is visualized through a NAMUR NE 107 icon in the following places:

- Left navigation bar
- Diagnostics tab
- Top-level DTM information section "Overall status".

**NAMUR NE 107 Diagnostic Information**

NAMUR NE 107 Icon	Diagnostic Information
	Good: No failure
	Maintenance required: Maintenance demanded, Maintenance
	Out of specification: Invalid process condition
	Failure: Maintenance alarm



**Adjusting the Diagnostics**

1. Set or adjust the diagnostic information of the device as required.
2. Click on **Apply** to confirm.

**More Information**

For more information on diagnosis of the device, see chapter 6.3.

**10.3.3 Sensor Input Channels 1 ... 12**

The sensor input mode offers the use of up to 12 channels. Two sets of options for channel settings are available for the 2 measurement loops.

### 10.3.4 Tab "General"

This tab offers the option to view and enter general and batch information on the current channel. The settings apply to all sensor input modes.

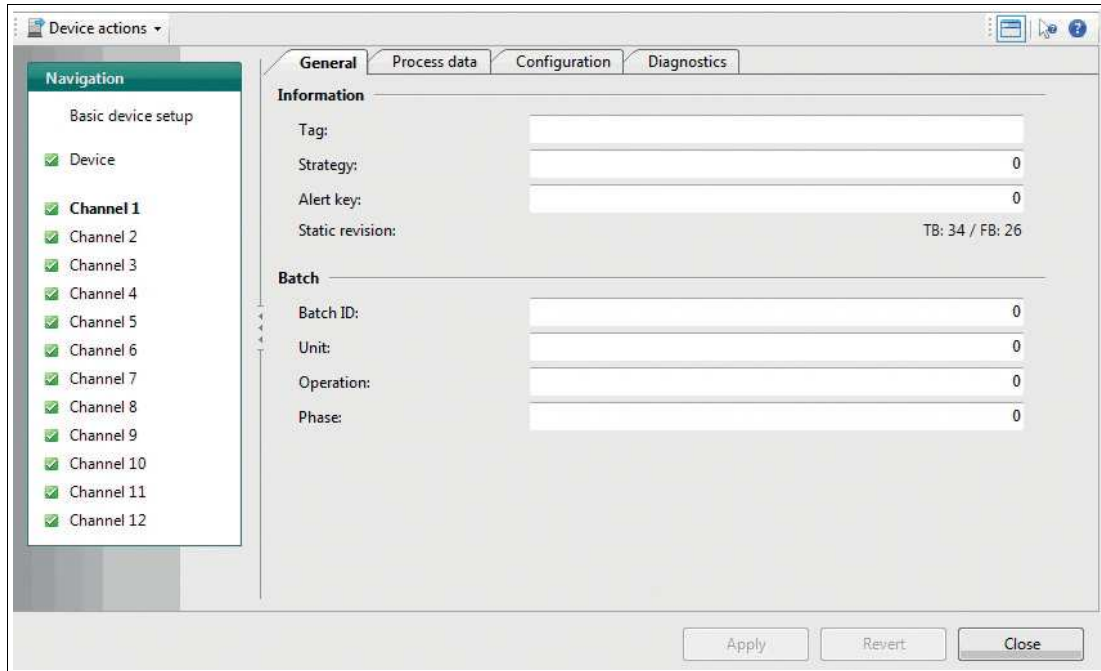

Figure 10.16 Channel "General" tab

The tab "General" contains the following parameters:

#### Section "Information":

- **Tag:** Tag assignment option.  
Free text field, assign a unique tag to each of the 12 channels of the MIO sensor input in the plant or process.
- **Strategy:** Code assignment option.  
Free value field, assign a user-specific code value to each of the 12 channels of the MIO sensor input. This code can be used for classifying and summarizing information, e. g., for diagnosis reports.
- **Alert key:** Code assignment option.  
Free value field, assign a user-specific code value to each of the 12 channels of the MIO sensor input. This code can be used for classifying and summarizing alarm messages and events, i. e., for quick localization.

#### General Parameter in the Online Mode

The following parameters contain read-only information displayed in the online mode.

- **Static revision:**  
Incremental modification counter for counting each modification of a parameter to document the status of parameterization modification.  
This parameter counts changes in the online tabs General, Process Data, Configuration.

**Section "Batch":**

- **Batch ID:** Identification assignment option.  
Free value field, assign an identifier for a batch process with distributed fieldbus systems to enhance process identification.
- **Unit**  
Free value field, assign an identifier for a batch unit with distributed fieldbus systems to enhance process identification. Example: Enter number of recipe unit procedure or of unit.
- **Operation**  
Free value field, assign an identifier for a batch operation with distributed fieldbus systems to enhance process identification. Example: Enter number of recipe operation.
- **Phase**  
Free value field, assign an identifier for a phase with distributed fieldbus systems to enhance process identification. Example: Enter number of a recipe phase.



**Adjusting the General Settings**

1. Use the different fields to enter the information you require for your process.
2. Click on **Apply** to confirm.

**10.3.5 Tab "Process Data" for a Binary Input**

This tab contains all settings and parameters for the binary input of the channel and the fail-safe settings.

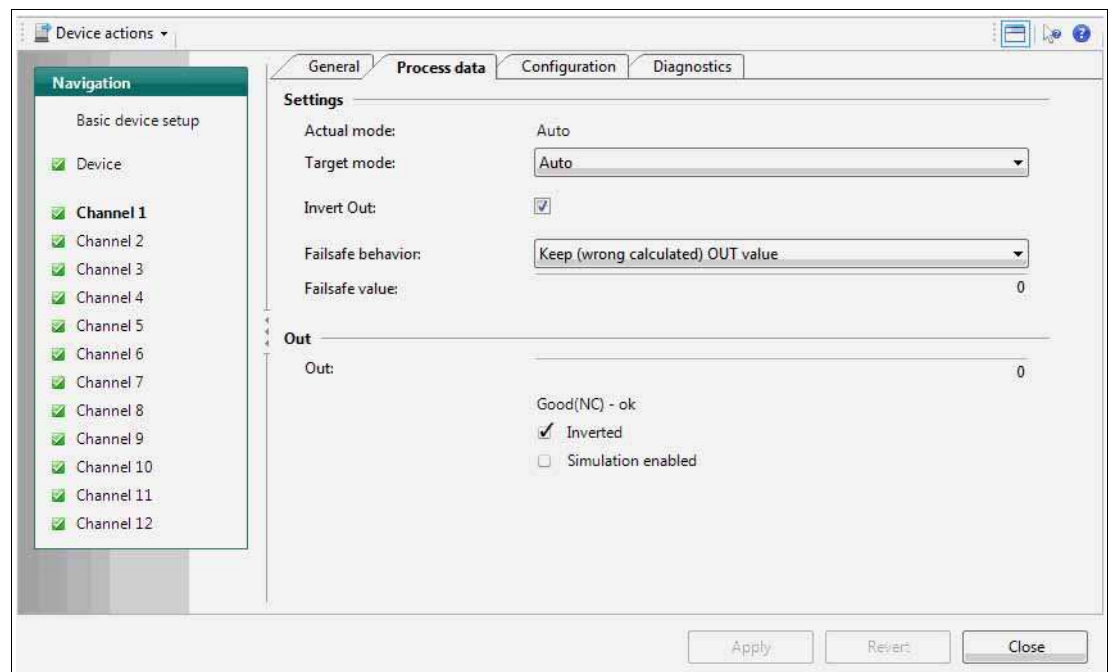

Figure 10.17 Channel "Process Data" tab for the binary input

The tab "Process data" contains the following channel information and parameters:

**Section "Settings":**

**Process Data Parameters in the Online Mode**

The following parameters contain read-only information displayed in the online mode.

■ **Actual mode**

Current mode of the channel. The mode can differ from the "Target mode".

Example: A different value or status is selected but the selection is not confirmed yet.

■ **Target mode:** Mode selection option per channel.

Choose the target mode of the output value for each of the 12 channels.

The following 3 modes are available:

- **Auto:** Automatic.  
The measured value of the device is used as output value.
- **Manual**  
Option to set the output value of the device manually.
- **Out of service**  
The channel is not in use and the output value is BAD.

**More Information**

For more information on the modes of operation, see chapter 8.2.

- **Invert OUT:** Determine whether the setpoint is logically inverted before writing to OUT in Auto mode.
- **Fail-safe behavior:** Defines the reaction of a device if a fault is detected.
  - Use fail-safe value as OUT
  - Use last valid OUT value
  - Keep (wrong calculated) OUT value
- **Fail-safe value:** Default value for the OUT parameter if a sensor or sensor electronics are detected. Ensure that the fail-safe behavior is set accordingly.

**More Information**

For more information on the fail-safe behavior, see chapter 9.1.3.

**Process Data Parameters in the Online Mode**

The following parameters contain read-only information displayed in the online mode.

**Section "OUT":**

- **OUT:** Process variable of the discrete input block in Auto mode. User-specified value defined in the manual mode or during operation. When the diagnostic status turns to BAD, the device uses the value specified in the fail-safe behavior.

The following 2 pull-down menus are active in case the actual mode is set to "Manual". In this case, you can make the settings for online diagnostic simulation purposes.

- OUT status type
- Alarm limits

■ **Inverted**

If this check box is shown as active, this confirms that the setpoint was logically inverted before writing to OUT in the target modes "Auto".

■ **Simulation enabled**

If this check box is shown as active this confirms that the "Simulation" for this MIO sensor input is enabled.



**More Information**

For more information on OUT status types, see chapter 4.3.2.  
For more information on simulation, see chapter 10.2.1.



**Adjusting the Process Data Settings**

1. Use the different fields and pull-down menus to enter the information you require for your process.
2. Click on **Apply** to confirm.

**10.3.6 Tab "Process Data" for a Frequency Input**

This tab contains all settings and parameters for the frequency input of the channel and the fail-safe settings.

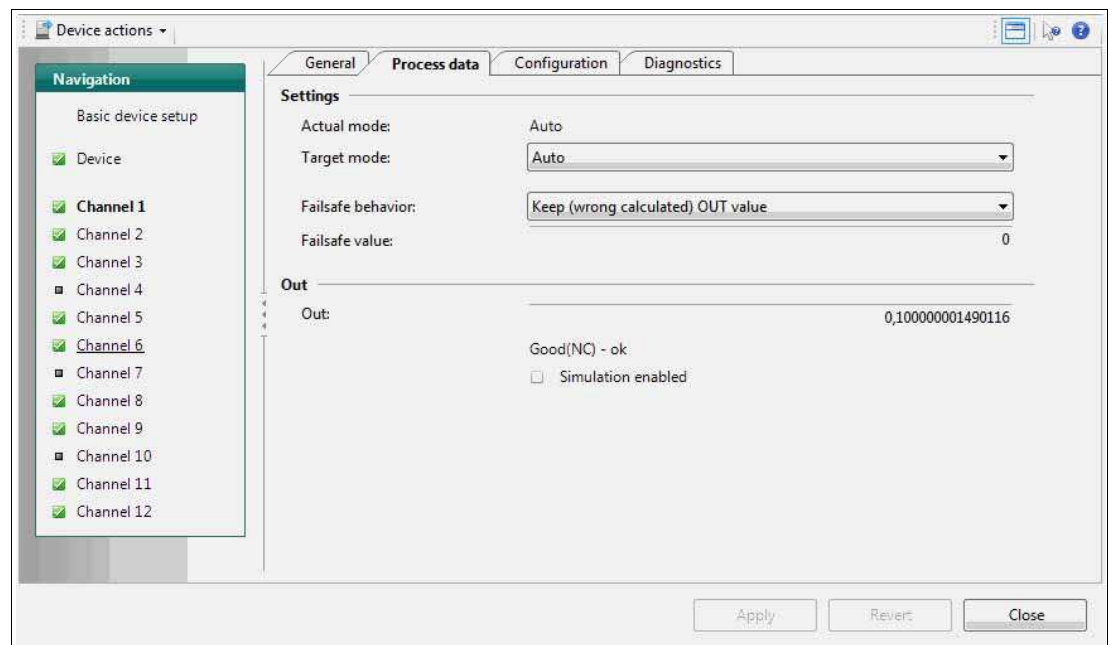

Figure 10.18 Channel "Process Data" tab for the frequency input

The tab "Process data" contains the following channel information and parameters:

**Section "Settings":**

**Process Data Parameters in the Online Mode**

The following parameters contain read-only information displayed in the online mode.

■ **Actual mode**

Current mode of the channel. The mode can differ from the "Target mode".

Example: A different value or status is selected but the selection is not confirmed yet.

- **Target mode:** Mode selection option per channel.  
Choose the target mode of the output value for each of the 8 channels.

The following 3 modes are available:

- **Auto:** Automatic.  
The measured value of the device is used as output value.
- **Manual**  
Option to set the output value of the device manually.
- **Out of service**  
The channel is not in use and the output value is BAD.

#### More Information

For more information on the modes of operation, see chapter 8.2.

- **Fail-safe behavior:** Defines the reaction of a device if a fault is detected.
  - Use fail-safe value as OUT
  - Use last valid OUT value
  - Keep (wrong calculated) OUT value
- **Fail-safe value:** Default value for the OUT parameter if a sensor or sensor electronics are detected. Ensure that the fail-safe behavior is set accordingly.

#### More Information

For more information on the fail-safe behavior, see chapter 9.1.3.

#### Process Data Parameters in the Online Mode

The following parameters contain read-only information displayed in the online mode.

##### Section "OUT":

- **OUT:** Process variable of the discrete input block in Auto mode. User-specified value defined in the manual mode or during operation. When the diagnostic status turns to BAD, the device uses the value specified in the fail-safe behavior.  
The following 2 pull-down menus are active in case the actual mode is set to "Manual". In this case, you can make the settings for online diagnostic simulation purposes.
  - OUT status type
  - Alarm limits
- **Simulation enabled**  
If this check box is shown as active this confirms that the "Simulation" for this MIO sensor input is enabled.

#### More Information

For more information on OUT status types, see chapter 4.3.2.  
For more information on simulation, see chapter 10.2.1.



### Adjusting the Process Data Settings

1. Use the different fields and pull-down menus to enter the information you require for your process.
2. Click on **Apply** to confirm.

### 10.3.7 Tab "Process Data" for a Counter

This tab contains all settings and parameters for the counter of the channel.

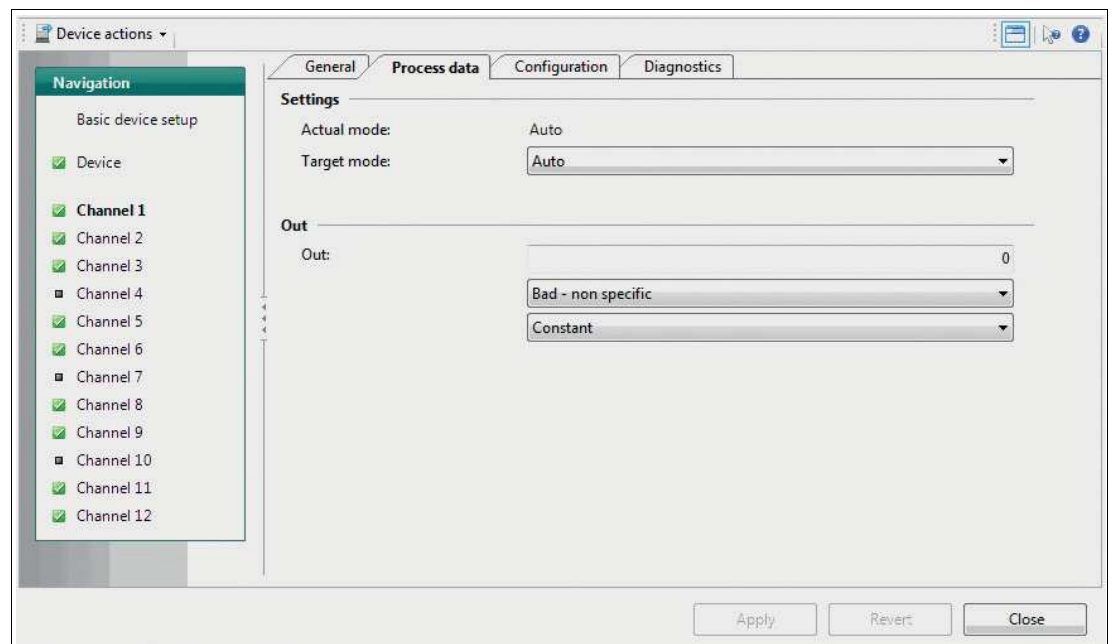

Figure 10.19 Channel "Process Data" tab for the counter

The tab "Process data" contains the following channel information and parameters:

#### Section "Settings":

##### Process Data Parameters in the Online Mode

The following parameters contain read-only information displayed in the online mode.

- **Actual mode**

Current mode of the channel. The mode can differ from the "Target mode".

Example: A different value or status is selected but the selection is not confirmed yet.

- **Target mode:** Mode selection option per channel.

Choose the target mode of the output value for each of the 8 channels.

The following 3 modes are available:

- **Auto:** Automatic.  
The measured value of the device is used as output value.
- **Manual**  
Option to set the output value of the device manually.
- **Out of service**  
The channel is not in use and the output value is BAD.

##### More Information

For more information on the modes of operation, see chapter 8.2.



**Process Data Parameters in the Online Mode**  
The following parameters contain read-only information displayed in the online mode.

**Section "OUT":**

- **OUT:** Process variable of the discrete input block in Auto mode. User-specified value defined in the manual mode or during operation.  
The following 2 pull-down menus are active in case the actual mode is set to "Manual". In this case, you can make the settings for online diagnostic simulation purposes.
  - OUT status type
  - Alarm limits

**More Information**

For more information on OUT status types, see chapter 4.3.2.  
For more information on OUT reset counter (OUT\_C\_RESET), see chapter 4.2.



### Adjusting the Process Data Settings

1. Use the different fields and pull-down menus to enter the information you require for your process.
2. Click on **Apply** to confirm.

### 10.3.8 Tab "Configuration"

This tab gives you several text-only fields that you can fill in as your process requires. Configure the sensor wire check. The settings apply to all sensor input modes.

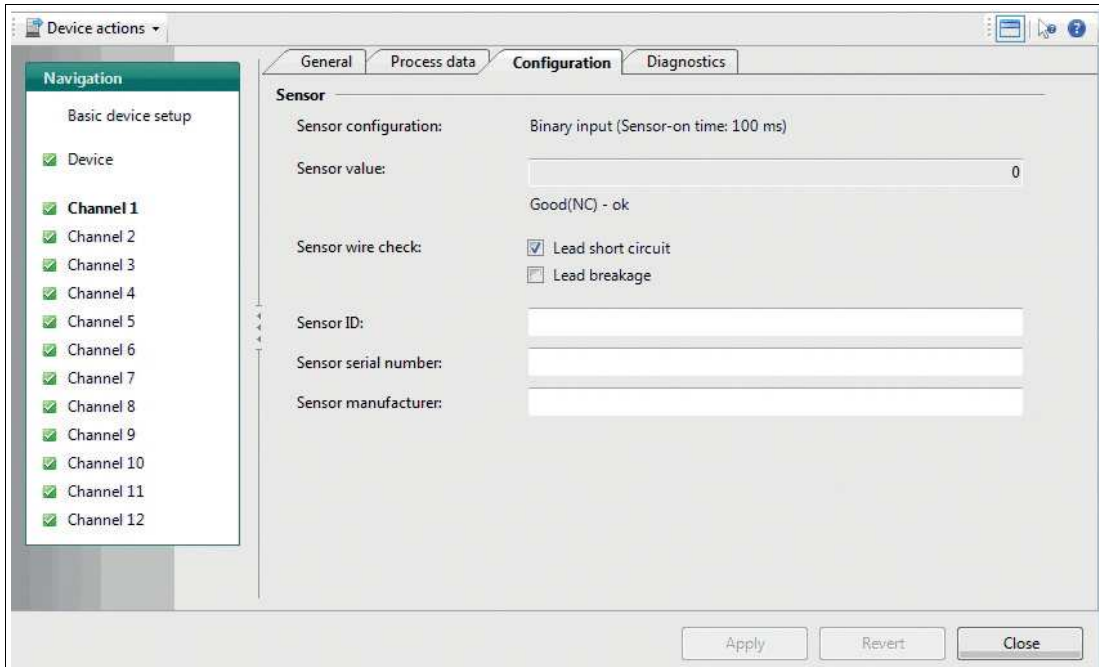

Figure 10.20 Channel "Configuration" tab

The tab "Configuration" contains the following channel information and parameters:

**Section "Sensor":**

- **Sensor configuration:** Information on how the channel is currently configured.

**Channel Parameters in the Online Mode**

**Sensor value**

This is the original, unaltered value that the sensor returns, before it is passed to the function block for further processing. If this value is "Bad", the fail-safe value is used as the OUT value in the tab "Process Data".

- **Sensor wire check:** Check boxes for enabling/disabling the following wire checks for the sensor:
  - Lead short circuit (not available for counter input model!)
  - Lead breakage

**More Information**

For more information on the sensor wire check, see chapter 9.3.1.

- **Sensor ID:** Optional text field for identification information on the sensor of the current channel.
- **Sensor serial number:** Optional text field for identification information on the sensor of the current channel.
- **Sensor manufacturer:** Optional text field for identification information on the sensor of the current channel.



**Adjusting the Configuration Settings**

1. Use the different text fields and check boxes to enter the information you require for your process.
2. Click on **Apply** to confirm.

### 10.3.9 Channel Tab "Diagnostics"

This tab contains information on the sensor wire. Also, the type of diagnosis and a related status can be configured. The settings apply to all sensor input modes.

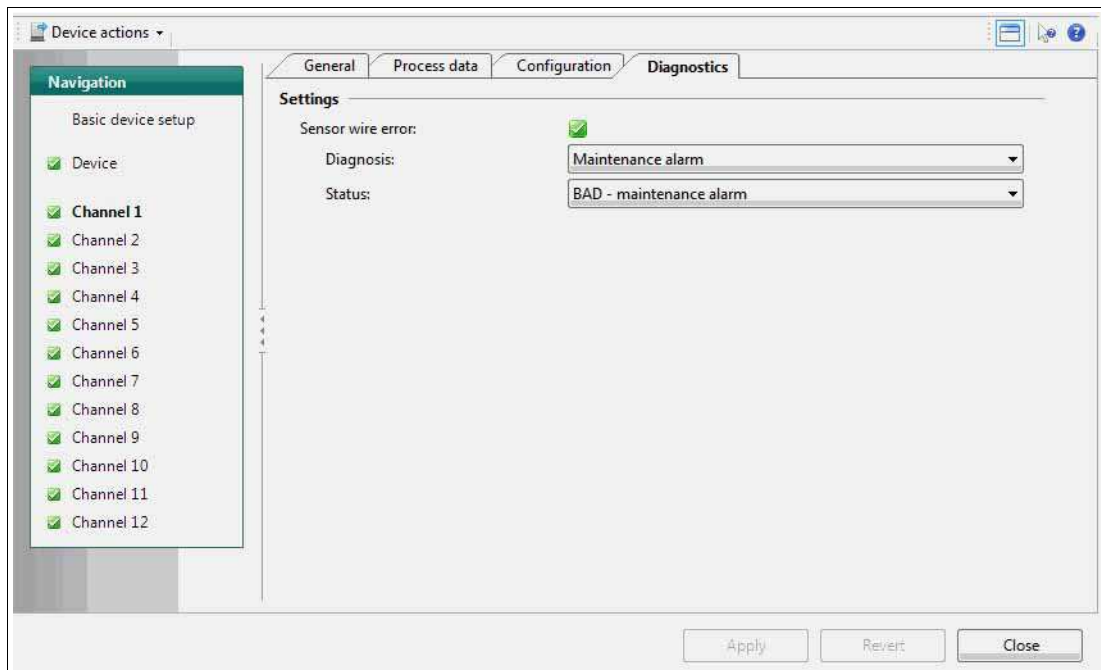

Figure 10.21 Channel "Diagnostics" tab

The tab "Diagnostics" contains the following channel information and parameters:

#### Section "Settings":

The following settings determine the reaction of the device on manufacturer-specific diagnostic events. For each error type you can determine how to diagnose it and determine the status that the process value issues in case of the diagnosis:





Error Type	Diagnosis	Status that the process value issues if the assigned diagnosis is active:
<b>Sensor wire error:</b>	<ul style="list-style-type: none"> <li>■ None</li> <li>■ Maintenance</li> <li>■ Maintenance demand</li> <li>■ Maintenance alarm</li> <li>■ Invalid process condition</li> <li>■ Function check</li> </ul>	<ul style="list-style-type: none"> <li>■ GOOD - OK</li> <li>■ GOOD - Maintenance required</li> <li>■ GOOD - Maintenance demanded</li> <li>■ UNCERTAIN - Maintenance demanded</li> <li>■ BAD - Maintenance alarm</li> <li>■ UNCERTAIN - Process-related, no maintenance</li> <li>■ BAD - Process-related, no maintenance</li> <li>■ BAD - Function check/ local override</li> <li>■ GOOD - Function check</li> </ul>

**Diagnostic Parameters in the Online Mode**

Diagnostic information is displayed additionally in the online mode in order to diagnose issues or failures in real-time as they occur. Any diagnostic information issued by the DTM is visualized through a NAMUR NE 107 icon in the following places:

- Left navigation bar
- Diagnostics tab
- Top-level DTM information section "Overall status".

**NAMUR NE 107 Diagnostic Information**

NAMUR NE 107 Icon	Diagnostic Information
	Good: No failure
	Maintenance required: Maintenance demanded, Maintenance
	Out of specification: Invalid process condition
	Failure: Maintenance alarm



### Adjusting the Diagnostics

1. Set or adjust the diagnostic information of the channel as required.
2. Click on **Apply** to confirm.

#### More Information

For more information on diagnosis of the device, see chapter 6.3.

## 10.4 Basic Device Setup in Valve Coupler Mode

The “Basic device setup” is the initial setting you must make before going into any further device setup or channel parameterization. In this section you set the MIO device up as a valve coupler.

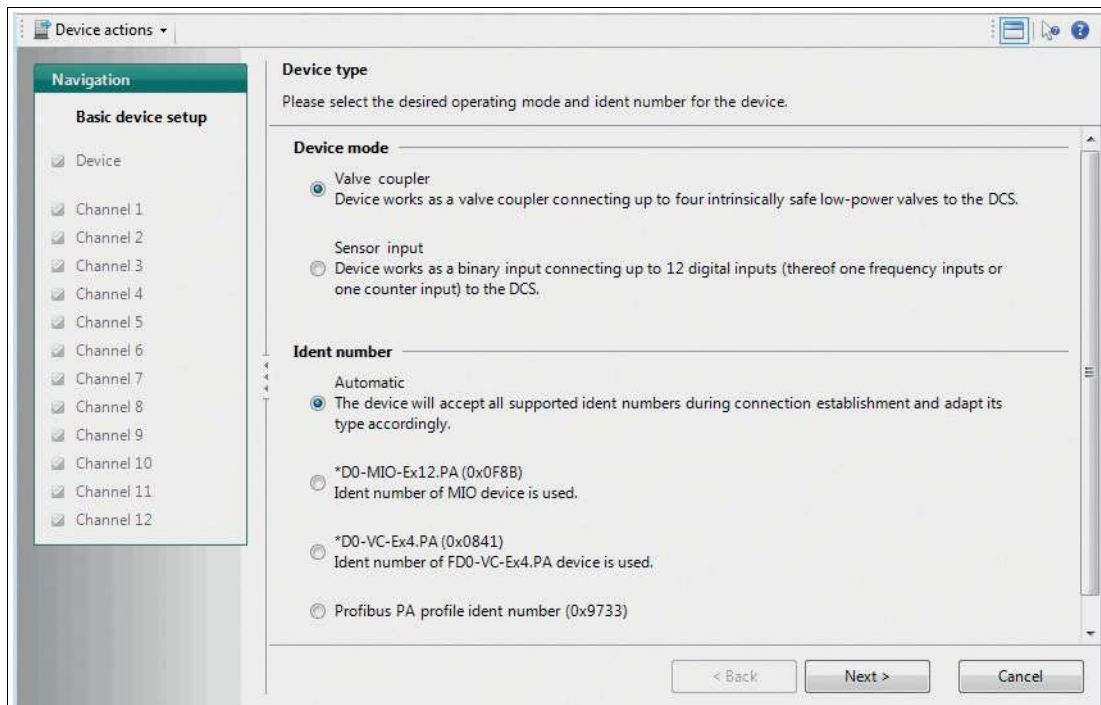

Figure 10.22 Channel "Basic Device Setup" tab: Select the device type

#### Section "Device mode":

Select the required device mode with the radio button.

#### More Information

For more information on the device modes, see chapter 2.2.

#### Section "Ident number":

Select the required ident number with the radio button.





**Note!**

**Changing the PROFIBUS Ident Number in the Online Mode**

If you use the menu command in online parameterization, a change of ident number selection takes immediate effect. The device is automatically rebooted with the ident number selected.

**More Information**

For more information on ident numbers, see chapter 3.3.



**Setting Up the MIO Device as a Valve Coupler**

1. Activate the Valve Coupler mode with the radio button.
2. Set the required ident number with the radio button.
3. Click on **Next** to confirm.
  - ↳ The parameter settings are adjusted for the device and a summarized overview of all the settings made is displayed.
4. Your basic device setup is complete. If you intend to change the settings, click on **Change Configuration** or on **Start** to restart the basic device setup.

10.4.1 Tab "Device Information"

This tab enables you to view or change device information as required, including general information on the sensor and identification information needed throughout your process.

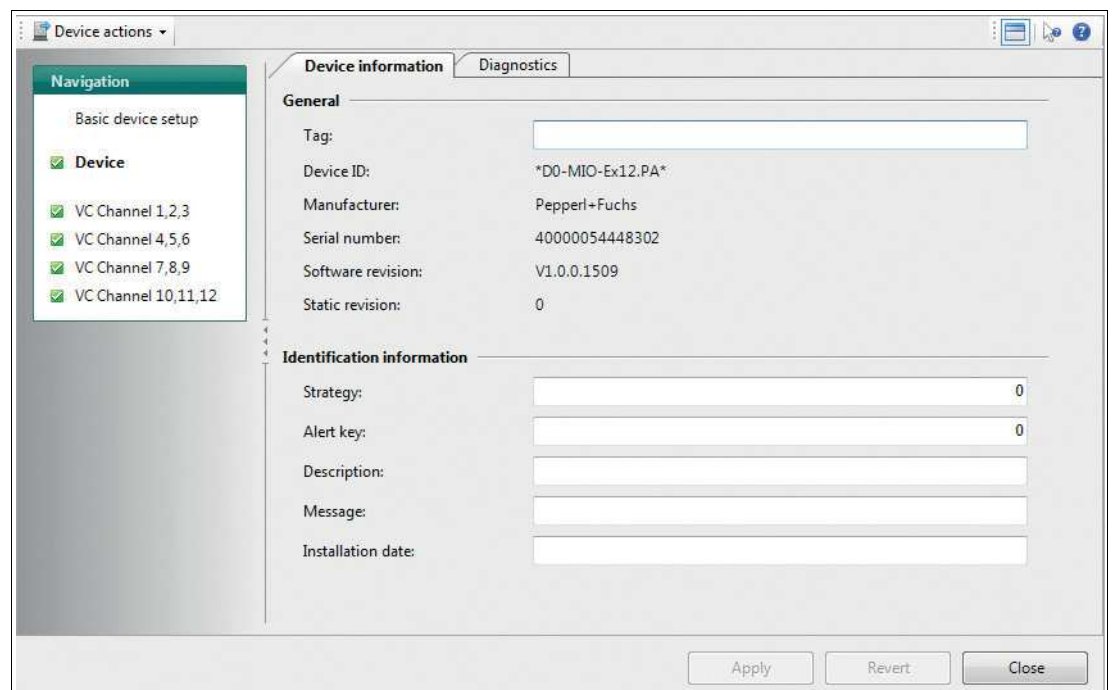

Figure 10.23 "Device Information" tab

The tab "Device Information" contains the following information and parameters:

**Section "General":**

- **Tag:** Free text field, enter a description of the device.
- **Device ID:** Read-only, manufacturer-specific description of the device.
- **Manufacturer:** Pepperl+Fuchs: Read-only, identification of the manufacturer of the device.

**Information Parameters in the Online Mode**

In the online mode, the following read-only information is displayed.

Use this data as additional diagnostic information when contacting Pepperl+Fuchs.

- **Serial number:** Serial number of the device
- **Software revision:** Software revision number
- **Static revision:** Incremental modification counter for counting each modification of a parameter to document the status of modification of parameterization.  
This parameter counts all changes in all device-specific online parameters.

**Section "Identification information":**

- **Strategy:** Free value field, enter value to use for configuration or diagnostics as a code key for sorting or summarizing diagnostic information.
- **Alert key:** Free value field, enter any value for sorting alarms or events that have been generated. The value can contain the identification number of the plant unit. It helps to identify the location (plant unit) of an event.
- **Description:** Free text field, enter any information to describe the device as a measuring point in the application.
- **Message:** Free text field, enter any information to describe the device in the application or plant.
- **Installation date:** Free text field, enter the installation date of the device in the plant.



**Adjusting the Device Information**

1. Use the different fields to enter the information you require for your process.
2. Click on **Apply**.

**More Information**

For more information on the identification information, see chapter 3.3.

## 10.4.2 Device Tab "Diagnostics"

In the DTM, the tab "Diagnostics" enables you to configure the diagnostic behavior of the device.

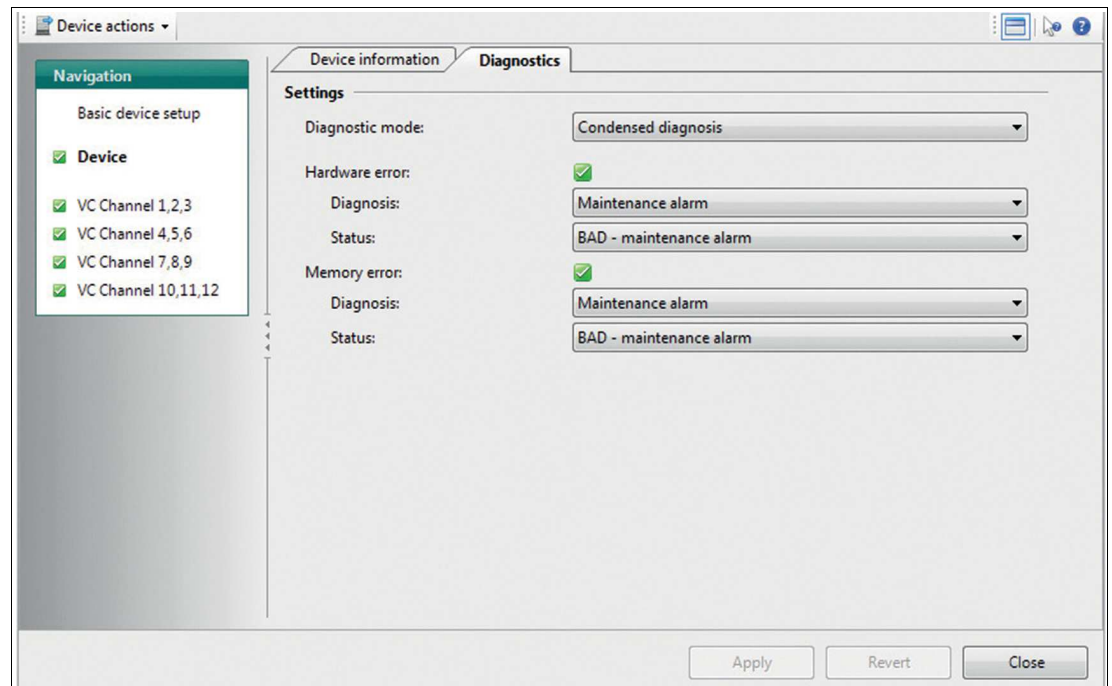

Figure 10.24 Device "Diagnostics" tab

The tab "Diagnostics" contains the following parameters:

### Section "Settings":

- **Diagnostic mode:** Mode selector to be configured for status and diagnostic behavior. Keep "Condensed diagnosis" or select "Classic diagnosis".
- **Hardware error:** Type of diagnostic message and the mapping with the status this message implies.
- **Memory error:** Type of diagnostic message and the mapping with the status this message implies.



### Note!

#### **Diagnostic Type for Cyclic Communication**

Setting the diagnostic type to classic or condensed status in the tab Device determines the diagnostic type of the cyclic communication between the device and the DTM.





The following settings determine the reaction of the device on manufacturer-specific diagnostic events. For each error type you can determine how to diagnose it and determine the status that the process value issues in case of the diagnosis:

Error Type	Diagnosis	Status that the process value issues if the assigned diagnosis is active:
Hardware error:	<ul style="list-style-type: none"> <li>■ None</li> <li>■ Maintenance</li> <li>■ Maintenance demand</li> <li>■ Maintenance alarm</li> <li>■ Invalid process condition</li> <li>■ Function check</li> </ul>	<ul style="list-style-type: none"> <li>■ GOOD - OK</li> <li>■ GOOD - Maintenance required</li> <li>■ GOOD - Maintenance demanded</li> <li>■ UNCERTAIN - Maintenance demanded</li> <li>■ BAD - Maintenance alarm</li> <li>■ UNCERTAIN - Process-related, no maintenance</li> <li>■ BAD - Process-related, no maintenance</li> <li>■ BAD - Function check/ local override</li> <li>■ GOOD - Function check</li> </ul>
Memory error:		

**Diagnostic Parameters in the Online Mode**  
 Diagnostic information is displayed additionally in the online mode in order to diagnose issues or failures in real-time as they occur. Any diagnostic information issued by the DTM is visualized through a NAMUR NE 107 icon in the following places:

- Left navigation bar
- Diagnostics tab
- Top-level DTM information section "Overall status".

**NAMUR NE 107 Diagnostic Information**

NAMUR NE 107 Icon	Diagnostic Information
	Good: No failure
	Maintenance required: Maintenance demanded, Maintenance
	Out of specification: Invalid process condition
	Failure: Maintenance alarm



### Adjusting the Diagnostics

1. Set or adjust the diagnostic information of the device as required.
2. Click on **Apply** to confirm.

#### More Information

For more information on diagnosis of the device, see chapter 6.3.

### 10.4.3 Valve Coupler Connections 1 ... 4

The valve coupler mode offers the use of up to 4 connections. The following options for channel settings are identical for all 4 valve coupler connections.

### 10.4.4 Tab "General"

This tab offers the option to view and enter general and batch information on the current channel.

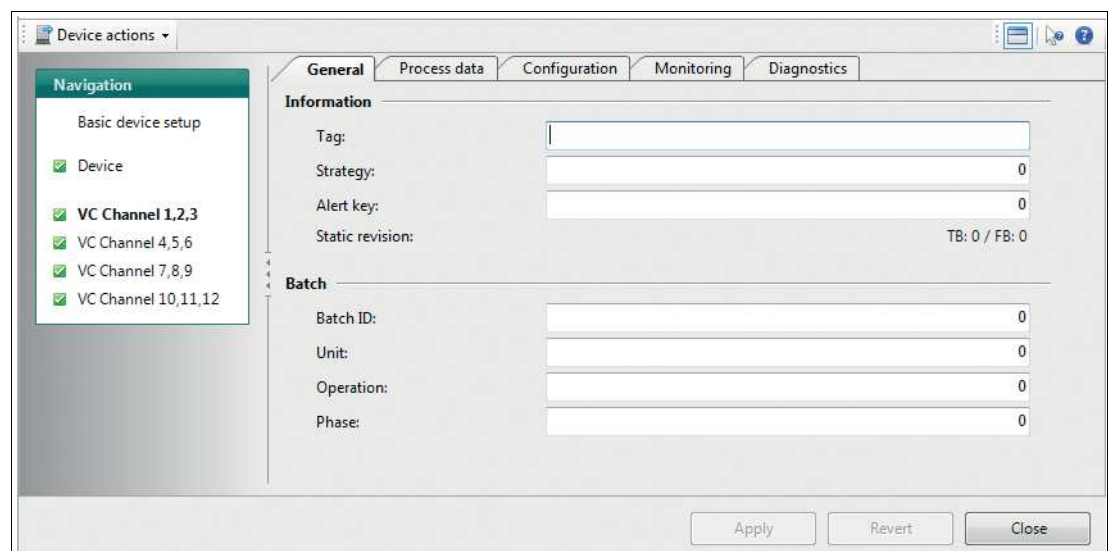

Figure 10.25 Channel "General" tab

The tab "General" contains the following parameters:

#### Section "Information":

- **Tag:** Tag assignment option.  
Free text field, assign a unique tag to each of the 12 channels of the MIO sensor input in the plant or process.
- **Strategy:** Code assignment option.  
Free value field, assign a user-specific code value to each of the 12 channels of the MIO sensor input. This code can be used for classifying and summarizing information, e. g., for diagnosis reports.
- **Alert key:** Code assignment option.  
Free value field, assign a user-specific code value to each of the 12 channels of the MIO sensor input. This code can be used for classifying and summarizing alarm messages and events, i. e., for quick localization.

#### General Parameter in the Online Mode

The following parameters contain read-only information displayed in the online mode.

- **Static revision:**

Incremental modification counter for counting each modification of a parameter to document the status of parameterization modification.

This parameter counts changes in the online tabs General, Process Data, Configuration.

#### Section "Batch":

- **Batch ID:** Identification assignment option.

Free value field, assign an identifier for a batch process with distributed fieldbus systems to enhance process identification.

- **Unit**

Free value field, assign an identifier for a batch unit with distributed fieldbus systems to enhance process identification. Example: Enter number of recipe unit procedure or of unit.

- **Operation**

Free value field, assign an identifier for a batch operation with distributed fieldbus systems to enhance process identification. Example: Enter number of recipe operation.

- **Phase**

Free value field, assign an identifier for a phase with distributed fieldbus systems to enhance process identification. Example: Enter number of a recipe phase.



#### Adjusting the General Settings

1. Use the different fields to enter the information you require for your process.
2. Click on **Apply** to confirm.

### 10.4.5 Tab "Process Data"

This tab contains all settings and parameters to determine the mode the channel is supposed to work in, a possible setpoint inversion, and the fail-safe settings. The tab offers readback and checkback information.

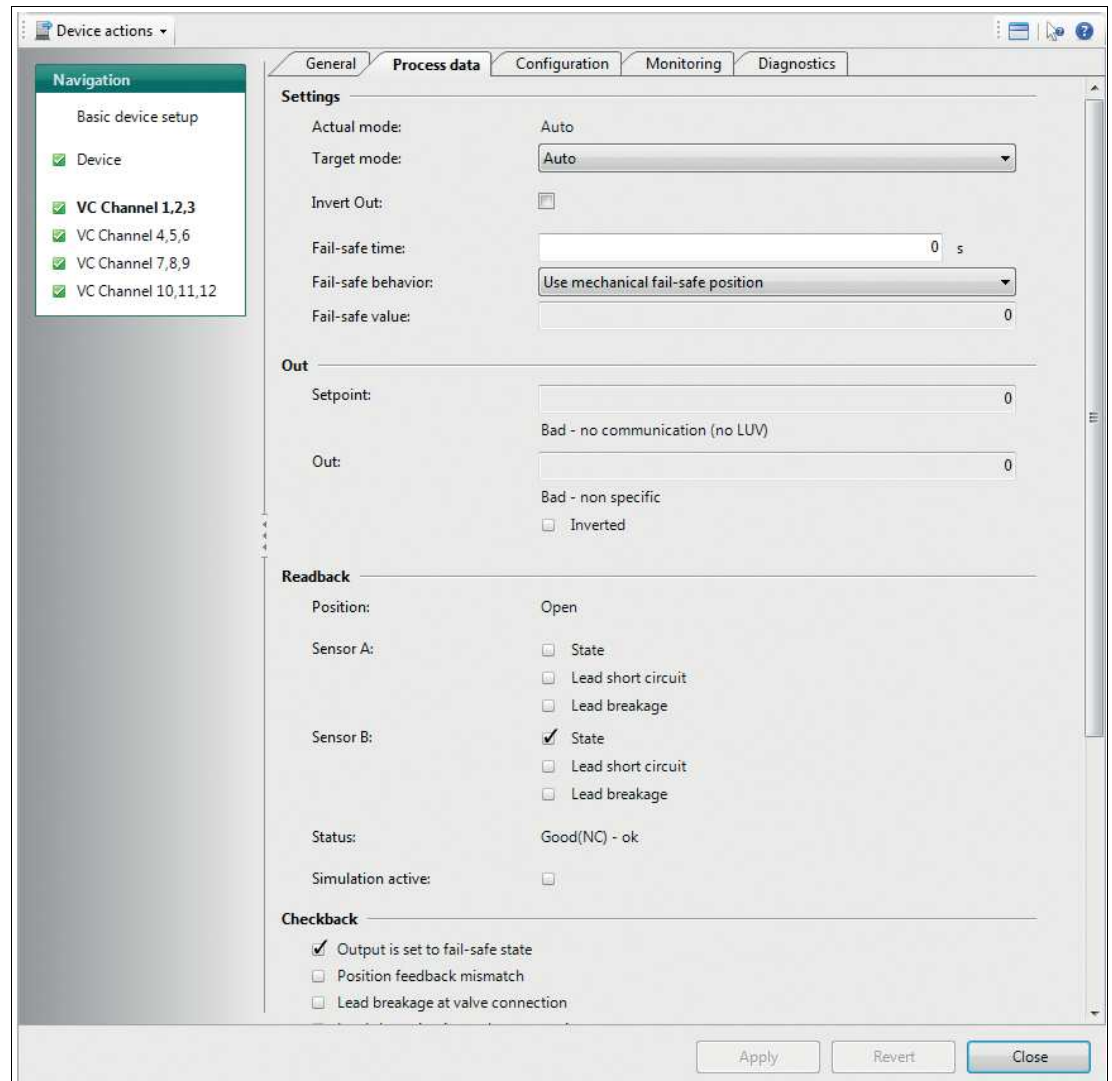

Figure 10.26 Channel "Process Data" tab

The tab "Process data" contains the following channel information and parameters:

#### Section "Settings":

##### Process Data Parameters in the Online Mode

The following parameters contain read-only information displayed in the online mode.

- **Actual mode**

Current mode of the channel. The mode can differ from the "Target mode".

Example: A different value or status is selected but the selection is not confirmed yet.

- **Target mode:** Mode selection option per channel.  
Choose the target mode of the output value for each of the 12 channels.

For the channels 1 ... 4, the following 4 modes are available:

- **Remote-Cascade:** (RCas)  
Mode to prevent the channel from automatically restarting when switching ON the device or when the status of the setpoint value has become "bad".
- **Auto:** Automatic.  
The measured value of the device is used as output value.
- **Manual**  
Option to set the output value of the device manually.
- **Out of service**  
The channel is not in use and the output value is BAD.

#### More Information

For more information on the modes of operation, see chapter 2.2.  
For more information on remote-cascade (RCas), see chapter 8.2.4.

- **Invert OUT:** Determine whether the setpoint is logically inverted before writing to OUT in Auto or RCAS mode.

#### More Information

For more information on inverting the setpoint parameters, SP\_D and RIN\_D, see chapter 8.1.

- **Fail-safe time:** Time in seconds from detection of failure of the actual used setpoint to the action of the function block if the condition still exists.
- **Fail-safe behavior:** Defines the reaction of a device if a fault is detected.
  - Use mechanical fail-safe position
  - Use last valid setpoint value
  - Use fail-safe value as setpoint
- **Fail-safe value:** Default value for the OUT parameter if a sensor or sensor electronics are detected. Ensure that the fail-safe behavior is set accordingly.

#### More Information

For more information on the fail-safe behavior, see chapter 8.2.3 and see chapter 8.2.4.  
For more information on the fail-safe mode, time, and value,



#### Process Data Parameters in the Online Mode

The following parameters contain read-only information displayed in the online mode.

##### Section "OUT":

###### ■ Setpoint

Current setpoint value and status of the channel.

Example: A different value or status is selected but the selection is not confirmed yet.

- **OUT:** Process variable of the discrete output block in Auto and RCAS mode. User-specified value defined in the manual mode or during operation. When the diagnostic status turns to BAD, the valve or actuator goes to the position specified in the fail-safe behavior defined by the mechanical fail-safe position.

The following 2 pull-down menus are active in case the actual mode is set to "Manual". In this case, you can make the settings for online diagnostic simulation purposes.

- OUT status type
- Alarm limits

###### ■ Inverted

If this check box is shown as active, this confirms that the setpoint was logically inverted before writing to OUT in the target modes "Auto" or "Remote-Cascade".

#### More Information

For more information on OUT\_D, see chapter 4.3.1.

For more information on simulation, see chapter 10.2.1.

For information on the mechanical fail-safe position, see chapter 10.4.6.

#### Section "Readback":

Contains resulting read-only information on feedback of the valve position, the states of the position inputs, and their lead faults.

- Position of the actuator/valve
- Sensor A wiring and sensor state
- Sensor B wiring and sensor state
- Status
- Simulation enabled/disabled

#### More Information

For more information on RB\_D, see chapter 4.3.1.

#### Section "Checkback":

Contains resulting read-only information on the detailed status, alarm, and fault signals of the valve. For full documentation of this information refer to:

#### More Information

For more information on CB\_D, see chapter 4.3.1.



## Adjusting the Process Data Settings

1. Use the different fields and pull-down menus to enter the information you require for your process.
2. Click on **Apply** to confirm.

### 10.4.6 Tab "Configuration"

This tab gives you several text-only fields that you can fill in as your process requires. Determine the mechanical fail-safe position, the sensor use and trigger the initialization run.

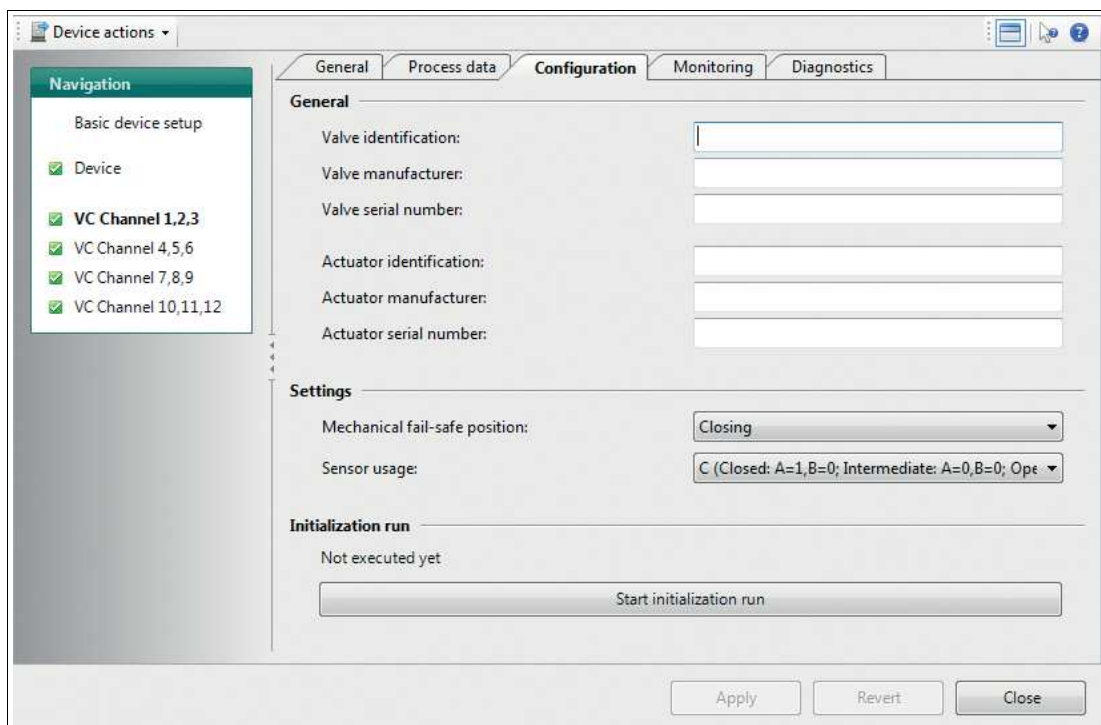

Figure 10.27 Channel "Configuration" tab

The tab "Configuration" contains the following channel information and parameters:

#### Section "General":

- **Valve identification** Optional text field for identification information on the valve of the current channel.
- **Valve manufacturer:** Optional text field for identification information on the valve of the current channel.
- **Valve serial number:** Optional text field for identification information on the valve of the current channel.
- **Actuator identification** Optional text field for identification information on the actuator of the current channel.
- **Actuator manufacturer:** Optional text field for identification information on the actuator of the current channel.
- **Actuator serial number:** Optional text field for identification information on the actuator of the current channel.

**Section "Settings":**

- **Mechanical fail-safe position:** Determines the safe position of the valve or actuator in case of power loss.

**More Information**

For more information on the actuator fail action, see chapter 8.3.1.

- **Sensor usage:** Maps the sensor position feedback signal with the valve positions according to the requirements of your process:
  - A (Closed: A=0, B=1; Intermediate: A=0, B=0; Open: A=1, B=1)
  - B (Closed: A=1, B=0; Intermediate: A=1, B=1; Open: A=0, B=1)
  - C (Closed: A=1, B=0; Intermediate: A=1, B=1; Open: A=0, B=1)
  - D (Closed: A=0, B=1; Intermediate: A=1, B=1; Open: A=1, B=0)
  - No position detection

**More Information**

For more information on the sensor usage, see chapter 8.3.2.

**Section "Initialization run":**

**Channel Configuration Option in the Online Mode  
Button "Initialization Run"**

Use the button to initiate a device- and manufacturer-specific calibration procedure.

**More Information**

For more information on the initialization run, see chapter 6.4.



**Adjusting the Configuration Settings**

1. Use the different text fields, pull-down menus, and the button to enter the information you require for your process or trigger a calibration process.
2. Click on **Apply** to confirm.

## 10.4.7 Tab "Monitoring"

This tab includes settings for the following monitoring activities: cyclic function test, wire check, breakaway and transit time, stroke count.

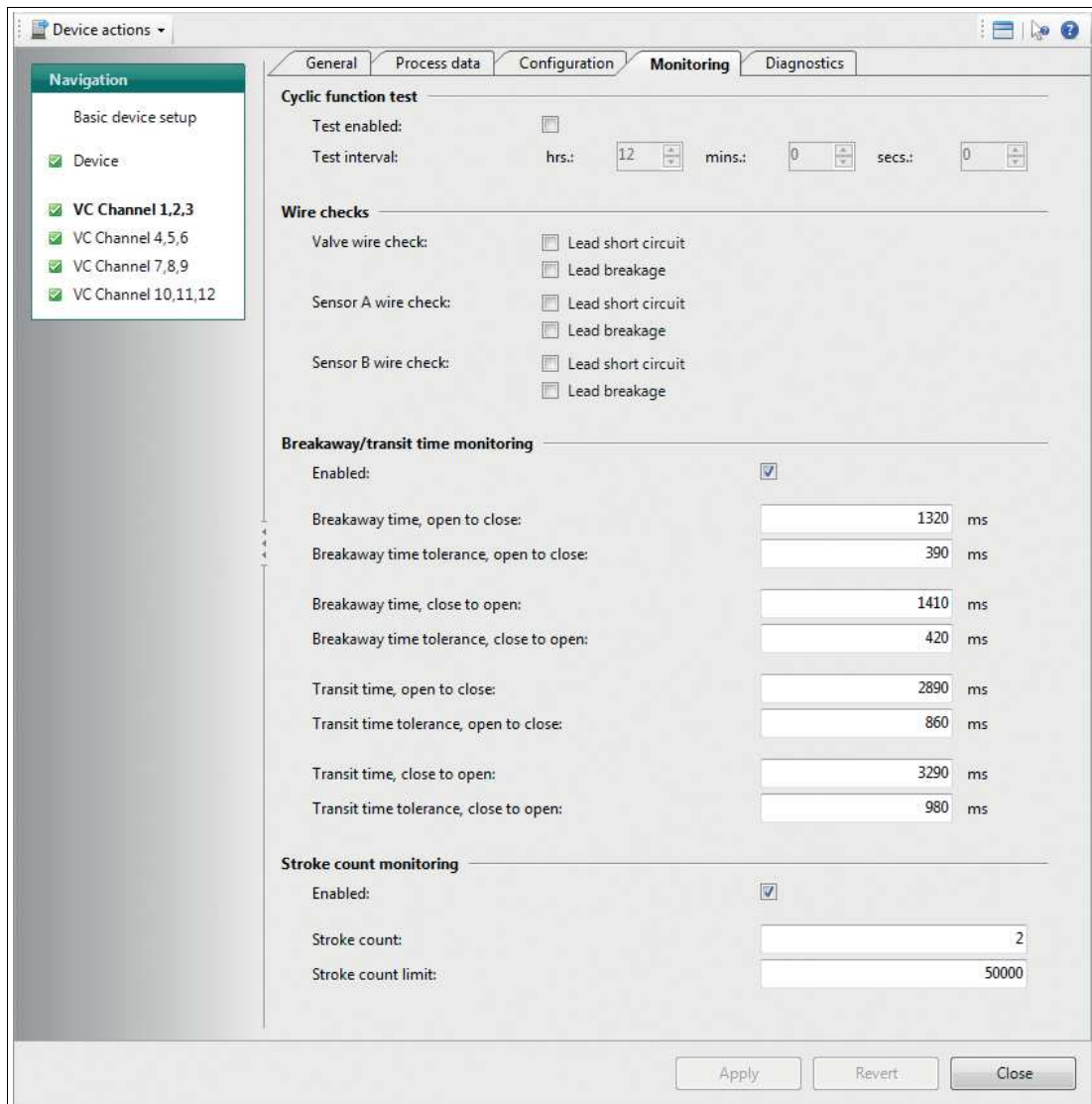

Figure 10.28 Channel "Monitoring" tab

The tab "Monitoring" contains the following channel information and parameters:

### Section "Cyclic function test":

Use this function test, e. g., for regular monitoring of a valve that is hardly triggered for correct functioning.

- **Test enabled:** Check box for enabling/disabling monitoring
- **Test interval:** Up-down input fields for setting the test interval in hh:mm:ss

### More Information

For more information on the cyclic function test, see chapter 8.4.4.

### Section "Wire check";

- **Valve wire check:** Enabling/disabling lead wire monitoring of the valve.
- **Sensor A wire check:** Enabling/disabling lead wire monitoring of sensor A.
- **Sensor B wire check:** Enabling/disabling lead wire monitoring of sensor B.

#### More Information

For more information on the wire check, see chapter 8.4.1.

### Section "Breakaway/transit time monitoring"

If required, you can set the MIO to monitor the breakaway and transit times of a valve.

- **Enabled:** Enabling/disabling monitoring for breakaway and transit times and tolerances.
- **Breakaway time, open to close:** Setpoint for the time between setting "Positioning value" to CLOSE and the indication that the valve leaves the state OPEN.
- **Breakaway time, tolerance, open to close:** Maximum allowed time difference between regular and measured breakaway time during OPEN to CLOSE.
- **Breakaway time, close to open:** Setpoint for the time between setting "Positioning value" to OPEN and the indication that the valve leaves the state CLOSE.
- **Breakaway time, tolerance, close to open:** Maximum allowed time difference between regular and measured breakaway time during CLOSE to OPEN.
- **Transit time, open to close:** Setpoint for the time between the changes of the state from OPEN to CLOSE.
- **Transit time, tolerance, open to close:** Maximum allowed time difference between regular and measured transit time during OPEN to CLOSE.
- **Transit time, close to open:** Setpoint for the time between the changes of the state from CLOSE to OPEN.
- **Transit time, tolerance, close to open:** Maximum allowed time difference between regular and measured transit time during CLOSE to OPEN.

#### More Information

For more information on time monitoring, see chapter 8.4.3.

### Section "Stroke count monitoring"

If required, you can set the MIO to monitor the number of strokes of a valve.

- **Enabled:** Enabling/disabling monitoring for number of strokes.
- **Stroke count:** Contains the current value of stroke counter. If changed, the stroke counter is set to the entered value
- **Stroke count limit:** Maximum allowed value for the stroke counter.

#### More Information

For more information on stroke count monitoring, see chapter 8.4.2.



## Adjusting the Monitoring Settings

1. Use the pull-down menus and check boxes to enter the information for the monitoring activities you require.
2. Click on **Apply** to confirm.

### 10.4.8 Channel Tab "Diagnostics"

This tab contains all information on monitored values, e. g., breakaway time, transit time, and stroke count, in case these monitorings were enabled. Also, the type of diagnosis and a related status can be configured for each diagnostic instance or error.

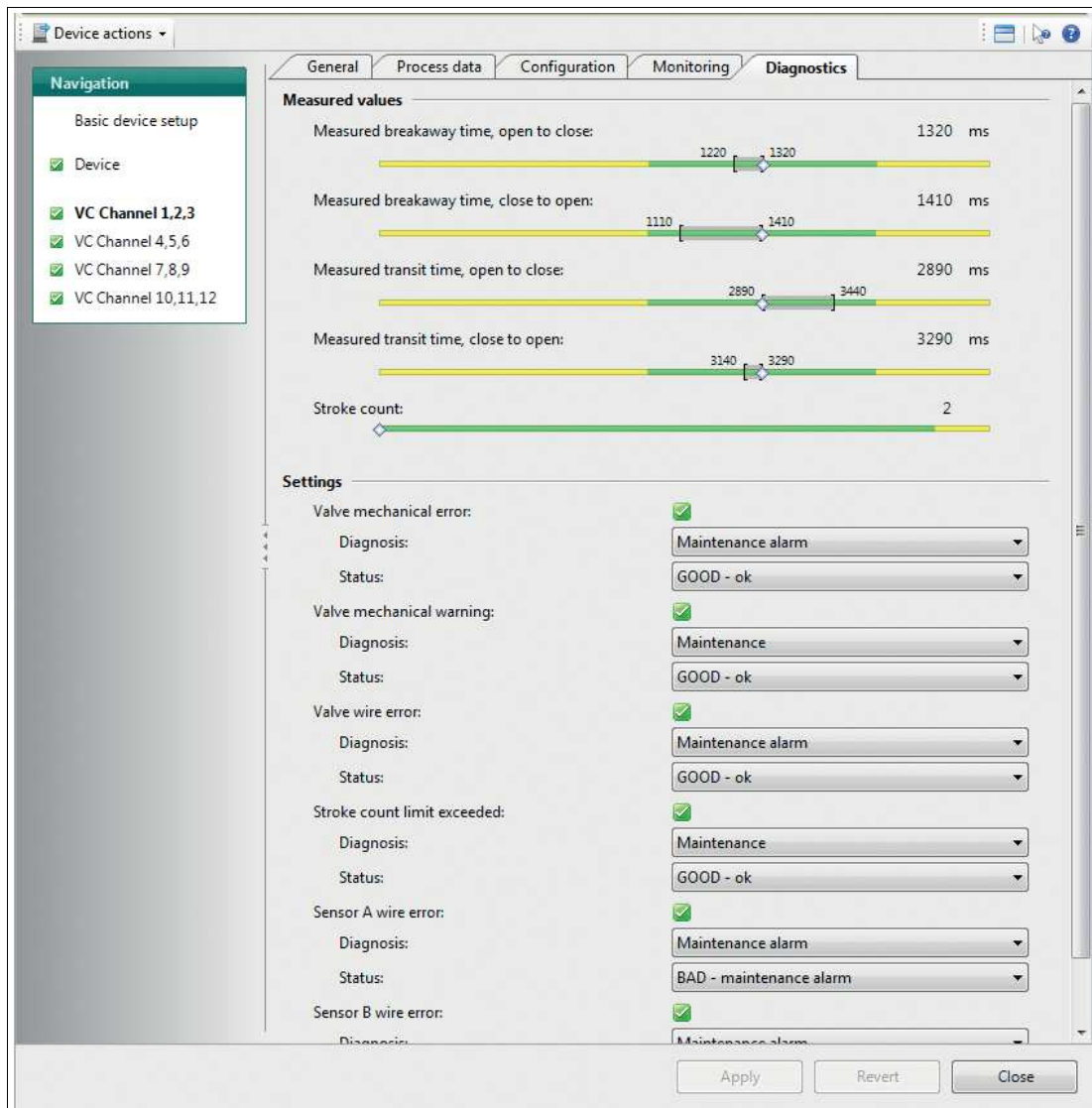

Figure 10.29 Channel "Diagnostics" tab

The tab "Diagnostics" contains the following channel information and parameters:

**Diagnostic Parameters in the Online Mode**

**Section "Measured values":**

Only available in the online mode. Visualizes the times and stroke counts for quick recognition.

This information is available only if breakaway/transit time monitoring or stroke count monitoring is enabled.

**Section "Settings":**

The following settings determine the reaction of the device on manufacturer-specific diagnostic events. For each error type you can determine how to diagnose it and determine the status that the process value issues in case of the diagnosis:

Error Type	Diagnosis	Status that the process value issues if the assigned diagnosis is active:
Valve mechanics error	■ None	■ GOOD - OK
Valve mechanics warning	■ Maintenance	■ GOOD - Maintenance required
Valve wire error	■ Maintenance demand	■ GOOD - Maintenance demanded
Stroke count limit exceeded	■ Maintenance alarm	■ UNCERTAIN - Maintenance demanded
Sensor A wire error	■ Invalid process condition	■ BAD - Maintenance alarm
Sensor B wire error	■ Function check	■ UNCERTAIN - Process-related, no maintenance
		■ BAD - Process-related, no maintenance
		■ BAD - Function check/ local override
		■ GOOD - Function check





**Diagnostic Parameters in the Online Mode**

Diagnostic information is displayed additionally in the online mode in order to diagnose issues or failures in real-time as they occur. Any diagnostic information issued by the DTM is visualized through a NAMUR NE 107 icon in the following places:

- Left navigation bar
- Diagnostics tab
- Top-level DTM information section "Overall status".



### NAMUR NE 107 Diagnostic Information

NAMUR NE 107 Icon	Diagnostic Information
	Good: No failure
	Maintenance required: Maintenance demanded, Maintenance
	Out of specification: Invalid process condition
	Failure: Maintenance alarm



### Adjusting the Diagnostics

1. Set or adjust the diagnostic information of the channel as required.
2. Click on **Apply** to confirm.

#### More Information

For more information on diagnosis of the device, see chapter 6.3 and see chapter 8.4.



# PROCESS AUTOMATION – PROTECTING YOUR PROCESS



## Worldwide Headquarters

Pepperl+Fuchs GmbH  
68307 Mannheim · Germany  
Tel. +49 621 776-0  
E-mail: [info@de.pepperl-fuchs.com](mailto:info@de.pepperl-fuchs.com)

For the Pepperl+Fuchs representative  
closest to you check [www.pepperl-fuchs.com/contact](http://www.pepperl-fuchs.com/contact)

[www.pepperl-fuchs.com](http://www.pepperl-fuchs.com)

 **PEPPERL+FUCHS**  
*PROTECTING YOUR PROCESS*

Subject to modifications  
Copyright PEPPERL+FUCHS • Printed in Germany

/ DOCT-5374B  
07/2018