

VisuNet AC Power Supply Unit

PSU1100-J1-AC-* and
PSU1200-J2-AC-*

Manual



With regard to the supply of products, the current issue of the following document is applicable:
The General Terms of Delivery for Products and Services of the Electrical Industry, published
by the Central Association of the Electrical Industry (Zentralverband Elektrotechnik und Elek-
troindustrie (ZVEI) e.V.) in its most recent version as well as the supplementary clause:
"Expanded reservation of proprietorship"

Worldwide

Pepperl+Fuchs Group
Lilienthalstr. 200
68307 Mannheim
Germany
Phone: +49 621 776 - 0
E-mail: info@de.pepperl-fuchs.com

North American Headquarters

Pepperl+Fuchs Inc.
1600 Enterprise Parkway
Twinsburg, Ohio 44087
USA
Phone: +1 330 425-3555
E-mail: sales@us.pepperl-fuchs.com

Asia Headquarters

Pepperl+Fuchs Pte. Ltd.
P+F Building
18 Ayer Rajah Crescent
Singapore 139942
Phone: +65 6779-9091
E-mail: sales@sg.pepperl-fuchs.com
<https://www.pepperl-fuchs.com>

1	Introduction.....	4
1.1	Content of this Document.....	4
1.2	Target Group, Personnel	4
1.3	Symbols Used	5
2	Product Description	6
2.1	Product Description	6
2.2	Technical Specification	8
2.3	Scope of Delivery.....	10
2.4	Dimensions and Labels.....	10
3	Installation.....	12
3.1	General Installation Requirements	12
3.2	Electrical Installation - Terminal Compartment	12
3.3	Mechanical Installation	17
3.3.1	Preferred Mounting Orientation.....	17

1 Introduction

1.1 Content of this Document

This document contains information that you need in order to use your product throughout the applicable stages of the product life cycle. These can include the following:

- Product identification
- Delivery, transport, and storage
- Mounting and installation
- Commissioning and operation
- Maintenance and repair
- Troubleshooting
- Dismounting
- Disposal



Note

This document does not substitute the instruction manual.



Note

For full information on the product, refer to the instruction manual and further documentation on the Internet at www.pepperl-fuchs.com.



Note

For specific device information such as the year of construction, scan the QR code on the device. As an alternative, enter the serial number in the serial number search at www.pepperl-fuchs.com.

The documentation consists of the following parts:

- Present document
- Instruction manual
- Datasheet

Additionally, the following parts may belong to the documentation, if applicable:

- EU-type examination certificate
- EU declaration of conformity
- Attestation of conformity
- Certificates
- Control drawings
- Functional safety manual
- Additional documents

1.2 Target Group, Personnel

Responsibility for planning, assembly, commissioning, operation, maintenance, and dismantling lies with the plant operator.

Only appropriately trained and qualified personnel may carry out mounting, installation, commissioning, operation, maintenance, and dismantling of the product. The personnel must have read and understood the instruction manual and the further documentation.

Prior to using the product make yourself familiar with it. Read the document carefully.

1.3 Symbols Used

This document contains symbols for the identification of warning messages and of informative messages.

Warning Messages

You will find warning messages, whenever dangers may arise from your actions. It is mandatory that you observe these warning messages for your personal safety and in order to avoid property damage.

Depending on the risk level, the warning messages are displayed in descending order as follows:



Danger!

This symbol indicates an imminent danger.

Non-observance will result in personal injury or death.



Warning!

This symbol indicates a possible fault or danger.

Non-observance may cause personal injury or serious property damage.



Caution!

This symbol indicates a possible fault.

Non-observance could interrupt the device and any connected systems and plants, or result in their complete failure.

Informative Symbols



Note

This symbol brings important information to your attention.



Action

1. This symbol indicates a paragraph with instructions. You are prompted to perform an action or a sequence of actions.

2 Product Description

2.1 Product Description

The device is an apparatus certified for use in hazardous areas rated according to ATEX directive and IECEx Zones 1 and 21 and Zones 2 and 22 depending on the type version used. The device is also UL listed for use in Class I and Class II, Division 2 and Class III hazardous areas.

The device is an AC-DC power supply. The device sources explosion-protected equipment in the hazardous area. The device provides an output voltage of 24 V DC based on 115/230 V AC input voltage.

The output power has a derating from 50 °C to 65 °C (80 W to 50 W).

The device is optimized to be used with the following devices:

- Display Unit DPU1*00-*
- Thin Client Unit TCU1*00-*
- PC Unit PCU1*00-*



Figure 2.1

Component Overview

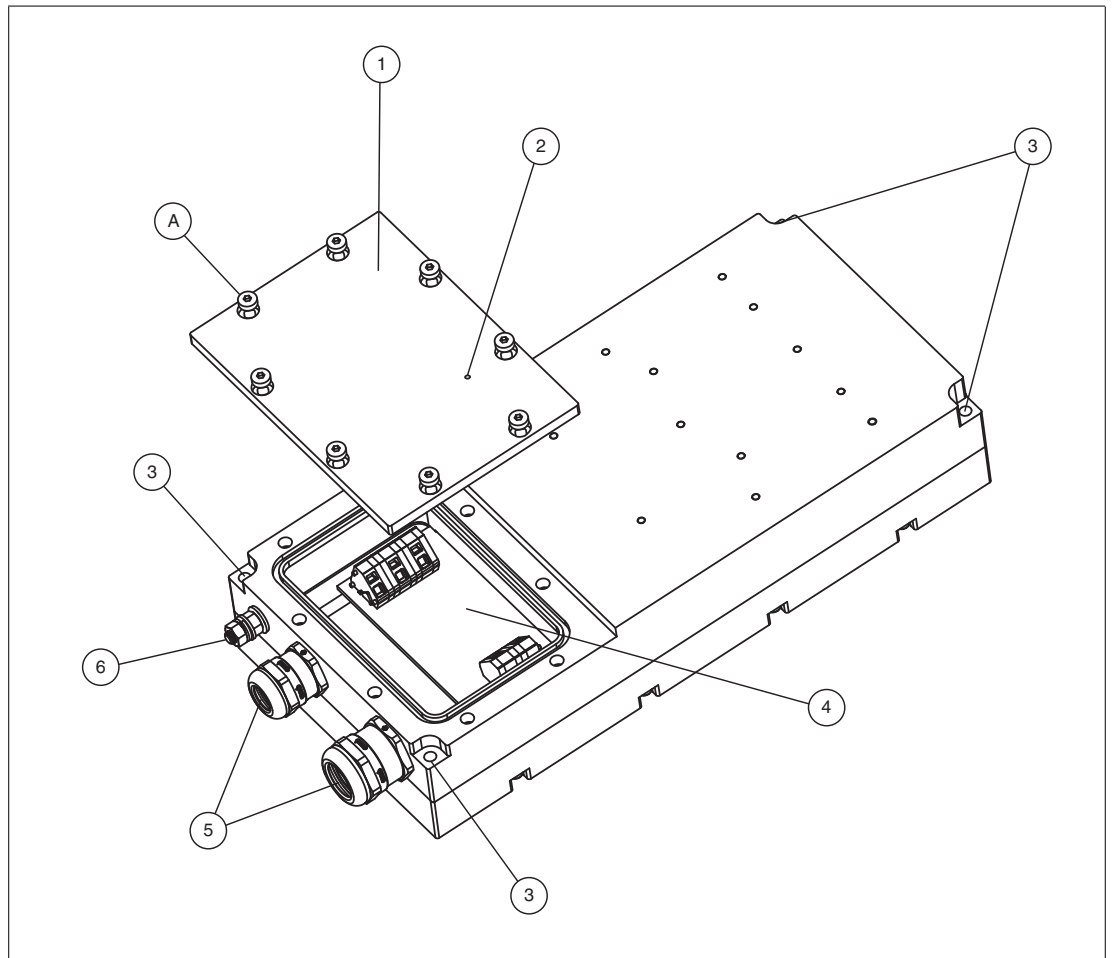

Figure 2.2

- 1 Terminal compartment cover
- 2 Breather vent
- 3 Mounting holes
- 4 Terminal compartment with 2 terminal blocks
- 5 Cable glands for power supply cables
- 6 Protective earth stud
- A Anti-loss mounting screws for terminal compartment cover



Danger!

Accumulation of condensed water within the housing can cause a short and result in an ignition.

A blocked breather vent cannot provide ventilation or drainage.

Do not block or restrict the breather vent! Do not insert any sharp objects into the breather vent!

2.2 Technical Specification

Technical Data

Supply	
Input voltage	115/230 V AC , 50/60 Hz
Input current	max. 1.3/0.7 A
Output	
Output rated operating current	max. 3.4 A
Voltage	24 V DC (SELV)
Power	80 W with derating
Power dissipation	15 W at 80 W output power
Ambient conditions	
Operating temperature	-20 ... 65 °C (-4 ... 149 °F) with derating
Storage temperature	-20 ... 65 °C (-4 ... 149 °F)
Relative humidity	93% at 40°C, non-condensating, according to EN 60068-2-78
Shock resistance	18 shocks 15 g , 11 ms all axis, IEC 60068-2-27
Mechanical specifications	
Core cross-section	max. 2.5 mm ² (14 AWG)
Degree of protection	IP66
HousingMaterial	anodized aluminum
Mass	approx. 3 kg
Dimensions	245 mm x 122 mm x 58 mm

Note

Environmental Conditions

This equipment is designed for indoor/outdoor use at a maximum altitude of 2000 m.

Marking







Power Supply PSU1100-J1-AC-*
Equipment protection level: Gb ATEX marking:  II 2G Ex eb q IIC T4 Gb IECEX marking: Ex eb q IIC T4 Gb
Equipment protection level: Db ATEX marking:  II 2D Ex tb IIIC T85°C Db IECEX marking: Ex tb IIIC T85°C Db
Power Supply PSU1200-J2-AC-*
Equipment protection level: Gc ATEX marking:  II 3G Ex ec q IIC T4 Gc IECEX marking: Ex ec q IIC T4 Gc
Equipment protection level: Dc ATEX marking:  II 3G Ex tc IIIC T85°C Dc IECEX marking: Ex tc IIIC T85C Dc

Table 2.1

2024-01

 68307 Mannheim, Germany www.pepperl-fuchs.com	
 LISTED	Class I, Division 2, Groups A, B, C, D; T4 Class II, Division 2, Groups F, G; T4 Class III -20°C ≤ Ta ≤ +50°C
Ind. Cont. Eq. for Haz. Loc. E492874	Class I Zone 2, Group IIC; T4 Class II Zone 22, Group IIIB; T85°C Class III Zone 22, Group IIIA; T85°C -20°C ≤ Ta ≤ +50°C
No user serviceable parts inside this enclosure. Aucune pièce réparable par l'utilisateur.	

UKEx Marking for PSU1100-J1-AC-*:

UKEx approval	Zone 1/21 CML 21UKEX3514X
Marking	II 2 G D Ex eb q IIC T4 Gb Ex tb IIIC T85°C Db

Derating

Power derating depending on temperature (convictional cooling) starting at 50 °C with 2 W/K derating with a maximum output power of 50 W at 65 °C ambient temperature.

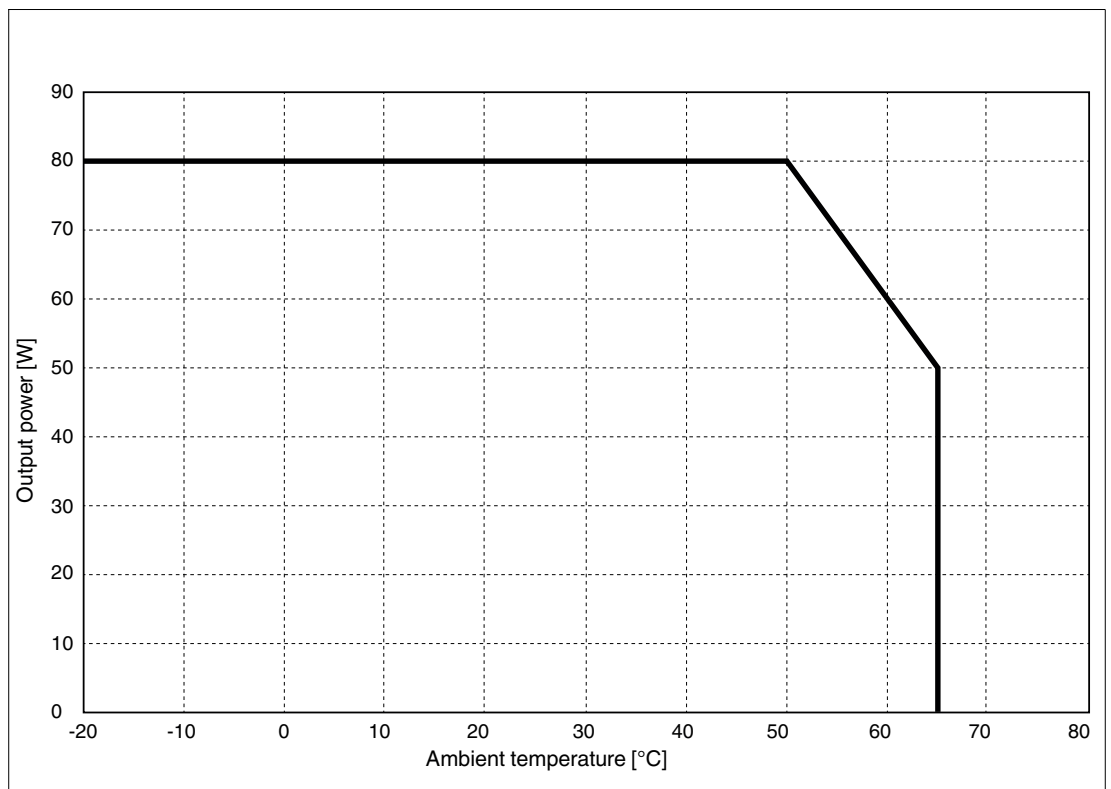

2.3 Scope of Delivery

115 V AC/230 V AC power supply

2.4 Dimensions and Labels

Dimensions

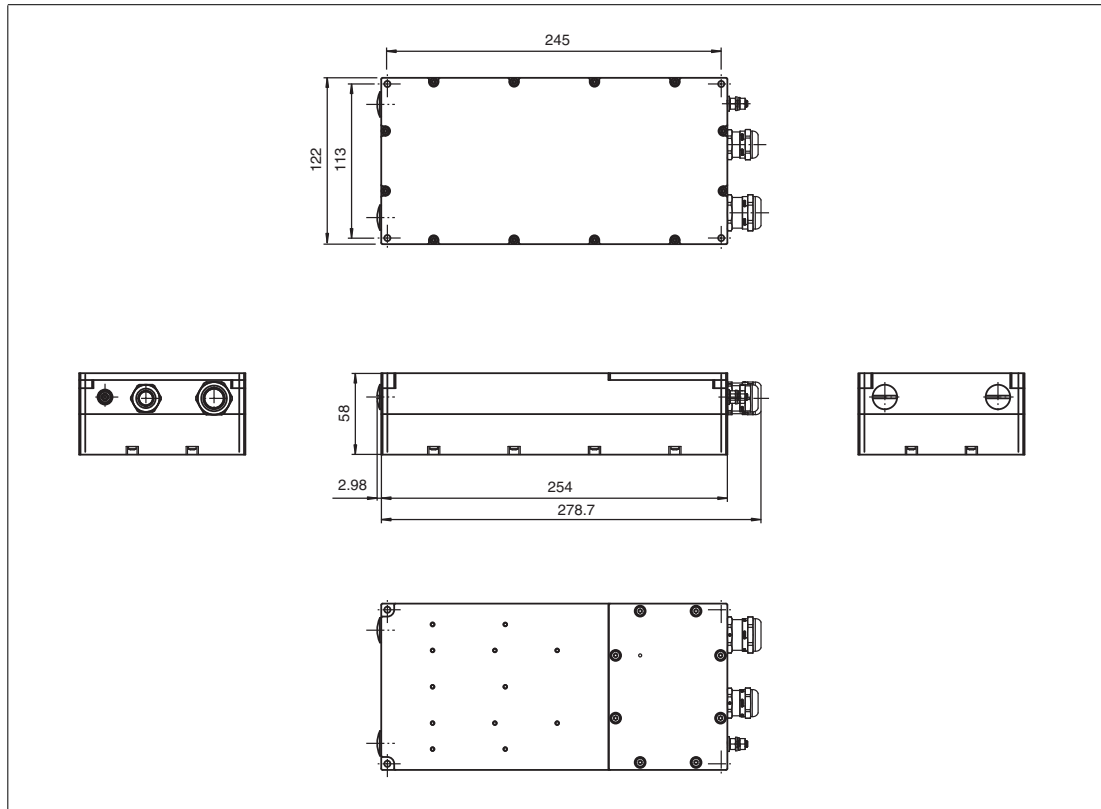

Figure 2.3 Power supply dimensions

Labels

The following labels are present on the power supply.

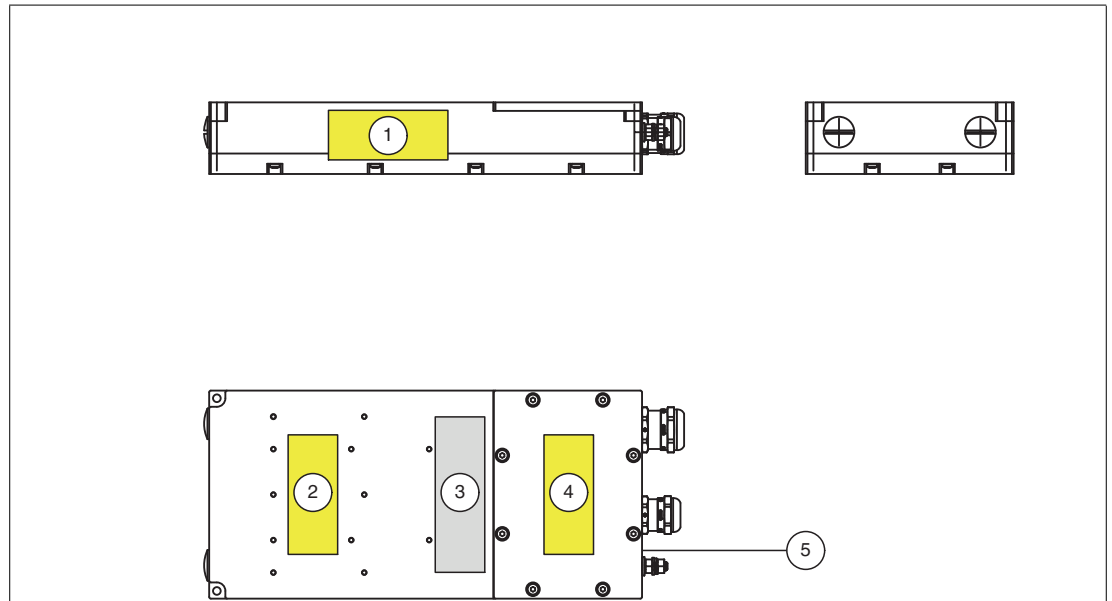
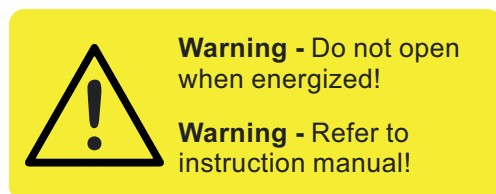
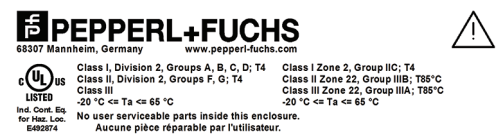
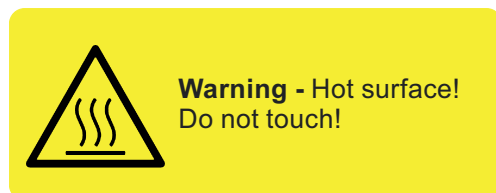
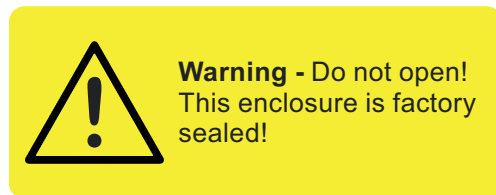

Figure 2.4 Position of the labels

- 1 Warning marking
"Warning – Do not open! This enclosure is factory sealed."
"Avertissement – Cette enveloppe est scellée en usine. Ne pas l'ouvrir!"
- 2 Warning marking
"Warning – Hot surface! Do not touch!"
"Avertissement – Surface chaude! Ne pas toucher!"
- 3 Nameplate example
- 4 Warning marking
"Warning – Do not open when energized!"
"Warning – Refer to instruction manual!"
"Avertissement – Ne pas ouvrir sous tension!"
"Avertissement – Reportez-vous au manuel d'instruction!"
- 5 Protective earth symbol



3 Installation

3.1 General Installation Requirements

Observe the following requirements when installing the power supply unit.

- The equipment must be installed by competent personnel in accordance with the instructions. National laws and regulations must be observed.
- The supply wiring for the power supply unit must be rated to at least 80 °C, if the power supply unit is used at an ambient temperature higher than 50 °C.
- The building installation must provide a 20 A overcurrent protection.
- The installer must make a readily accessible disconnect device available.
- The safety of any system incorporating the power supply unit is the responsibility of the assembler of the system.

3.2 Electrical Installation - Terminal Compartment

The terminal compartment comprises terminal blocks for the input voltage and for the output voltage.

The input is powered with 115 V AC/230 V AC by the customer's power cable.

The power supply provides 24 V DC on the output side.

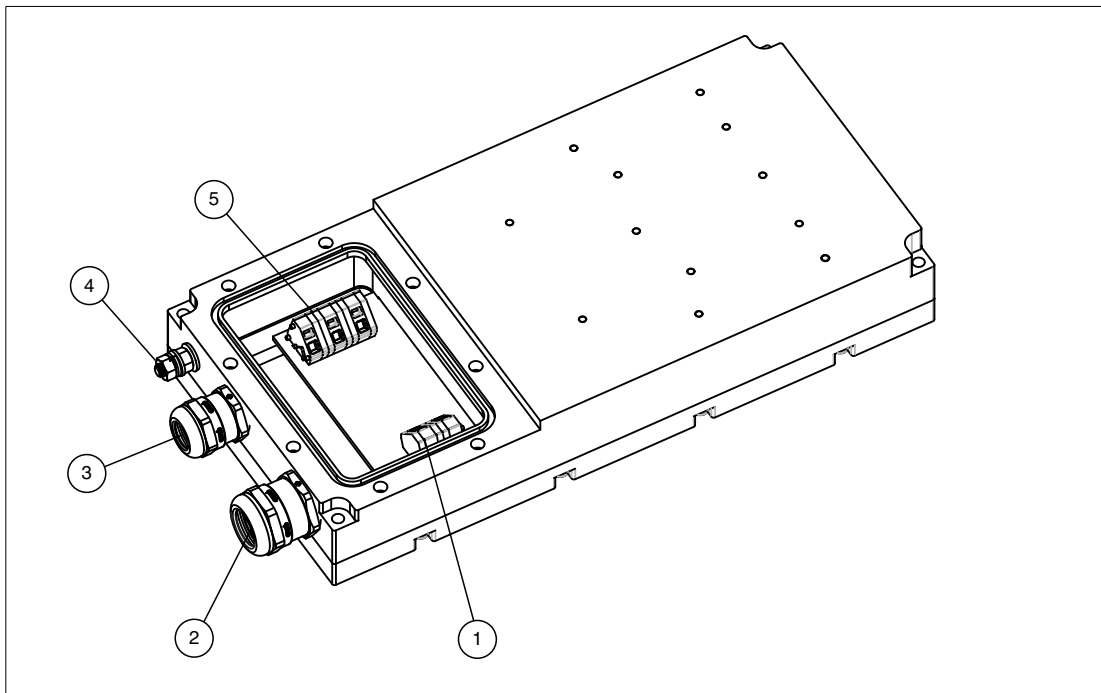

Figure 3.1

- 1 Output terminal block
- 2 Input cable gland
- 3 Output cable gland
- 4 Protective earth stud
- 5 Input terminal block

Cable Gland Connection Layout

The cable glands have different inlays in different sizes. Therefore, it is important to use the correct installation cables with the corresponding cable gland. Do not use the cable glands for any other cable than stated below. Do not interchange the cables.

	Cable gland used for:	Allowed Cable Diameter	Tightening Torque
2	Input cable gland	7-12 mm	5 Nm
3	Output cable gland	6-10 mm	

The connection layouts of the terminal blocks are as follows:

Field Input 115/230 V AC

	X1.1	PE
	X1.2	N
	X1.3	L

Table 3.1

Output 24 V DC

	X2.1	V+
	X2.2	V-

Table 3.2

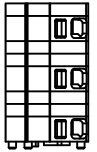
Before you begin the electrical installation make sure that the followings tools are present:

- Slot-head screwdriver for connecting cable and terminal block
- Allen key 2.5 mm (M3) for opening/closing terminal compartment
- Optional: stripping pliers for stripping cables, crimping tool

Core Cross-Section

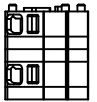
Type	mm ²	AWG
rigid	max. 2.5	max. 14
flexible	max. 2.5	max. 14

Table 3.3



Preparing the Power Cables for Electrical Installation

1. For both power cables (input power cable and output power cable): Strip the insulation of each stranded conductor to an appropriate length (approx. 8 mm).
2. Optional: crimp each stranded conductor with appropriate wire end ferrules. Use an appropriate crimping tool.



Installing the Input Power Cable and the Output Power Cables



Note

Criss-Crossed Cable Installation

For a convenient installation, Pepper+Fuchs recommends to install the power cables criss-crossed, see next figure. This will increase the bending radius and simplify the cable installation.

1. Open the terminal compartment by loosening the cover screws with an Allen key 2.5 mm (M3). Remove the terminal compartment cover.
2. Open both the input cable gland (2) and the output cable gland (3).
3. Insert the input power cable in the input cable gland (2).
4. Connect the cores of the input power cable to the terminals according to the connection layout. See table "Field Input 115/230 V AC" on page 13.
To simplify the installation, use the slot-head screwdriver to keep the spring terminal open. Insert the core and remove the slot-head screwdriver carefully. The spring terminal will close and the core is secured.
5. Insert the output power cable in the output cable gland (3).
6. Connect the cores of the output power cable to the terminals according to the connection layout. See table "Output 24 V DC" on page 13.
To simplify the installation, use the slot-head screwdriver to keep the spring terminal open. Insert the core and remove the slot-head screwdriver carefully. The spring terminal will close and the core is secured.
7. Tighten both the input cable gland (2) and the output cable gland (3). Tightening torque: 5 Nm.
8. Close the terminal compartment by putting the terminal compartment cover back. Use the criss-cross pattern shown below when closing the terminal. Tighten the screws by using an Allen key 2.5 mm (M3). Tightening torque: 1.5 Nm.

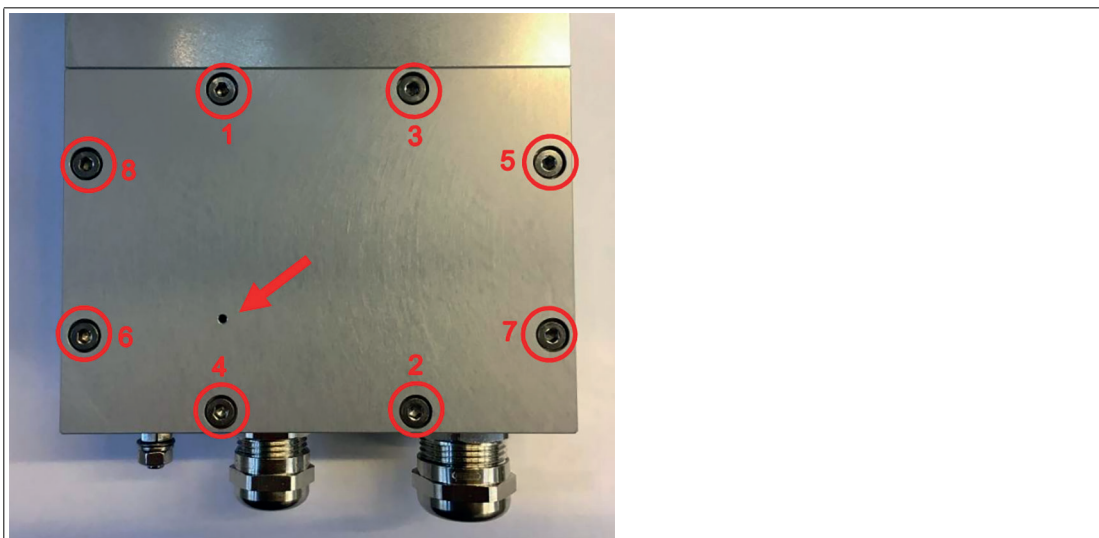

Figure 3.2

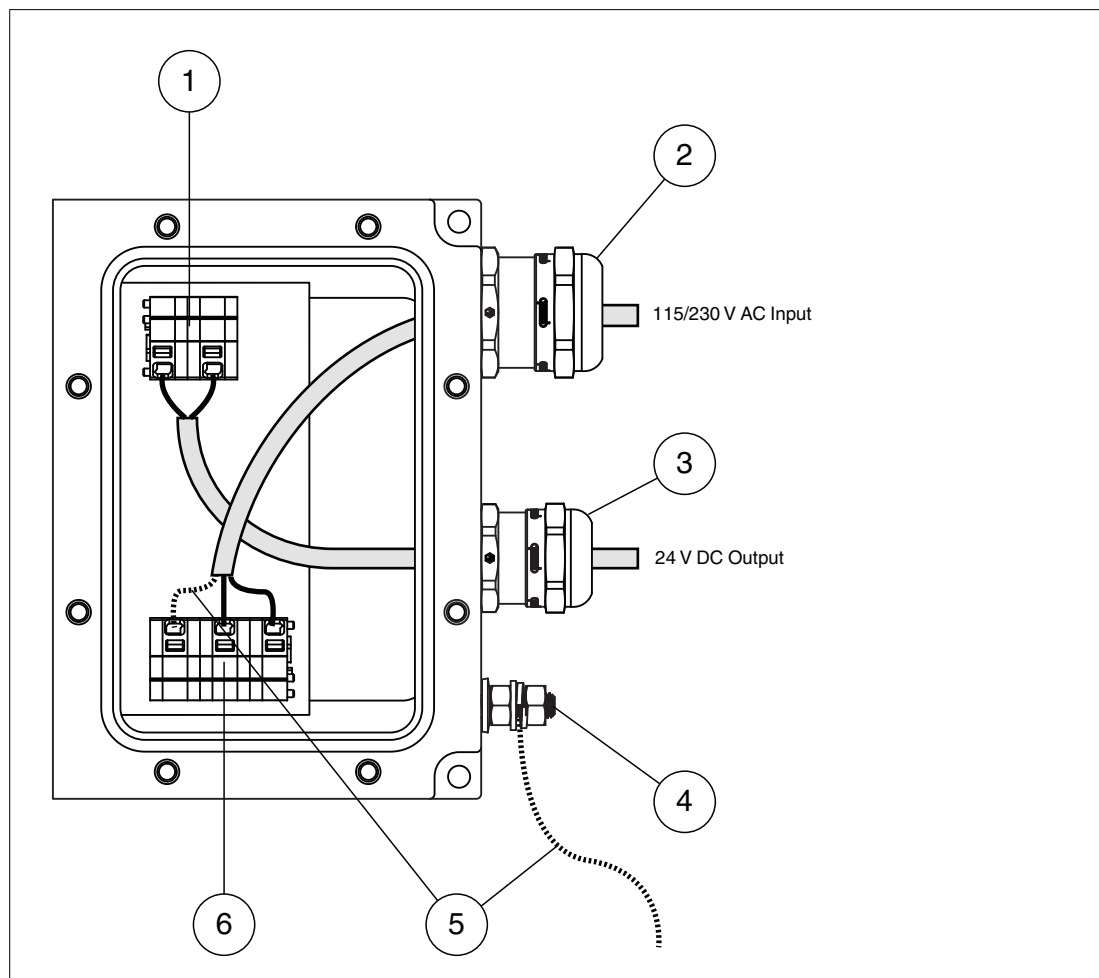

Figure 3.3

- 1 Output terminal block
- 2 Input cable gland
- 3 Output cable gland
- 4 Protective earth stud
- 5 External grounding (mandatory)
Internal grounding (optional)
- 6 Input terminal block

Protective Earthing and Grounding

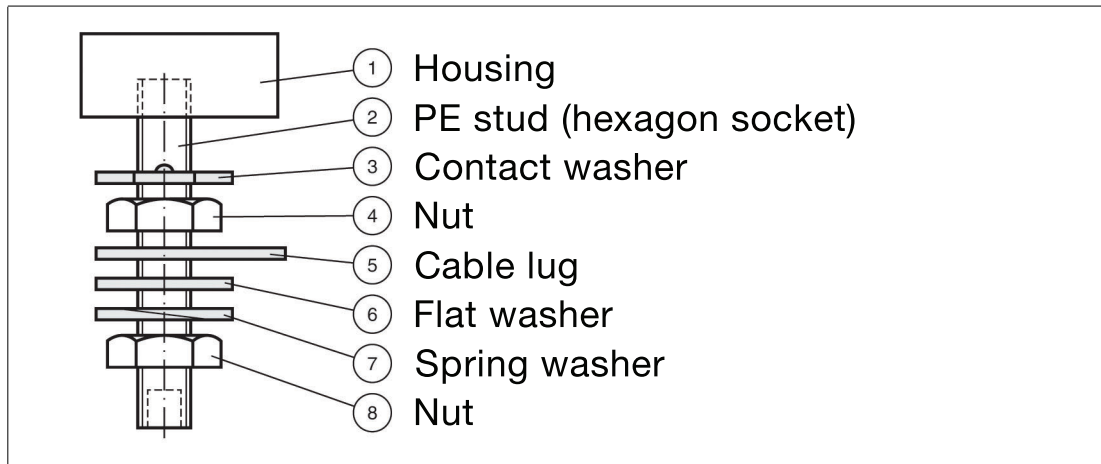

Figure 3.4

- | | |
|---|------------------------------|
| 1 | Power supply housing |
| 2 | Ground bolt (hexagon socket) |
| 3 | Contact washer |
| 4 | Nut |
| 5 | Cable lug |
| 6 | Flat washer |
| 7 | Spring washer |
| 8 | Nut |



Danger!

Explosion hazard from wrong or missing grounding

Wrong or missing grounding can cause sparks. This can ignite the surrounding potentially explosive atmosphere.

- Ground the device. Observe the grounding requirements.
- Ensure that external ground connections exist, are in good condition, and are not damaged or corroded.



Warning!

Risk of electric shock or property damage from inadequate grounding.

If you do not ground the device correctly, this could result in potential equalization currents. These currents could hurt operating personnel or cause property damage.

Ground the device via the grounding bolt. Optionally, ground the device additionally via the terminal X1.1. When both are used, ensure that a correct potential equalization is guaranteed at all times.



Grounding the Device

1. Ground the device via a ground bolt. Use a grounding cable with at least 4 mm² cross core section.
2. Optionally, ground the device additionally via the terminal X1.1.

3.3 Mechanical Installation

Drilling Pattern

For mounting the device to a wall or a floor use the following drilling pattern. Use suitable M4 screws to mount the device.

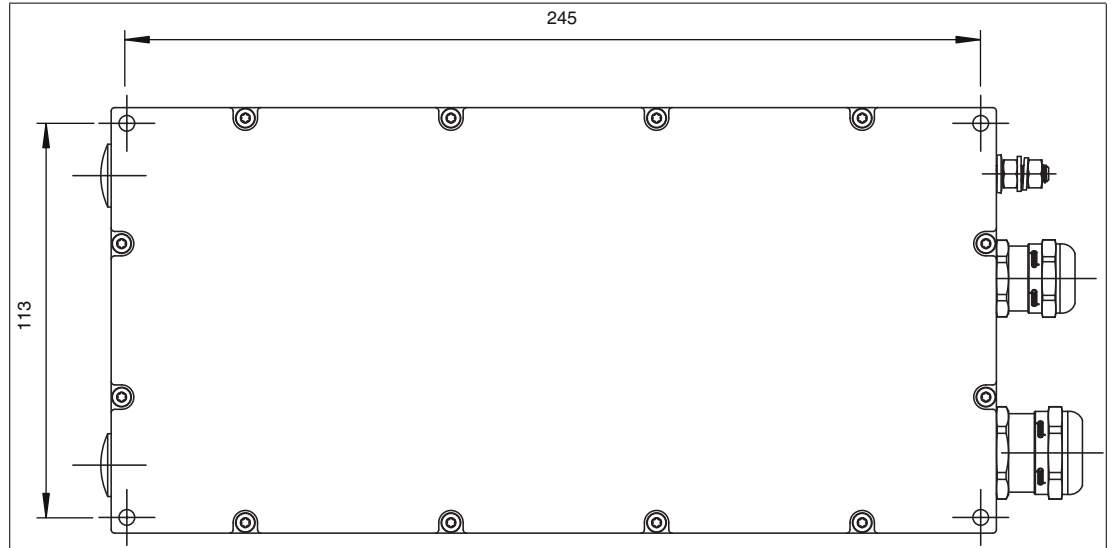

Figure 3.5

3.3.1 Preferred Mounting Orientation



Note

Possible Device Failure Due to Inadequate Heat Dissipation and Cooling

Inadequate heat dissipation and cooling can compromise the function and the electrical safety of the device.

- For proper operation, ensure optimal heat dissipation and cooling.
- Couple the power supply to surfaces that allow heat to be transferred away from the device.
- Ensure convection of the ambient air.
- Ensure that there is enough space (at least 10 cm) between the PSU and walls or other devices.
- Do not mount the device upside down. The nameplate must not face downward. All other orientations are allowed under the conditions mentioned above.



Danger!

Accumulation of condensed water within the housing can cause a short and result in an ignition.

A blocked breather vent cannot provide ventilation or drainage.

Do not block or restrict the breather vent! Do not insert any sharp objects into the breather vent!

Your automation, our passion.

Explosion Protection

- Intrinsic Safety Barriers
- Signal Conditioners
- FieldConnex® Fieldbus
- Remote I/O Systems
- Electrical Ex Equipment
- Purge and Pressurization
- Industrial HMI
- Mobile Computing and Communications
- HART Interface Solutions
- Surge Protection
- Wireless Solutions
- Level Measurement

Industrial Sensors

- Proximity Sensors
- Photoelectric Sensors
- Industrial Vision
- Ultrasonic Sensors
- Rotary Encoders
- Positioning Systems
- Inclination and Acceleration Sensors
- Fieldbus Modules
- AS-Interface
- Identification Systems
- Displays and Signal Processing
- Connectivity

Pepperl+Fuchs Quality

Download our latest policy here:

www.pepperl-fuchs.com/quality

