

## BRIEF INSTRUCTIONS

### Level Probe LGC2

Hydrostatic Level  
Measurement  
4 to 20 mA Analog



With regard to the supply of products, the current issue of the following document is applicable: The General Terms of Delivery for Products and Services of the Electrical Industry, published by the Central Association of the Electrical Industry (Zentralverband Elektrotechnik und Elektroindustrie (ZVEI) e.V.) in its most recent version as well as the supplementary clause: "Expanded reservation of proprietorship".

These Instructions are brief instructions; they are not a substitute for the manual pertaining to the device.

Detailed information about the device can be found in the manual and the other documentation via internet [www.pepperl-fuchs.com](http://www.pepperl-fuchs.com).

The complete device documentation consists of:

- these brief instructions
- the manuals
- the technical information
- the instruction manuals

<b>1</b>	<b>Important Document Information</b>	<b>5</b>
1.1	Document function	5
1.2	Document Conventions	5
1.3	Documentation	8
1.4	Terms and Abbreviations	9
1.5	Turn down calculation	10
<b>2</b>	<b>Basic Safety Instructions</b>	<b>11</b>
2.1	Requirements for the Personnel	11
2.2	Intended Use	11
2.3	Workplace Safety	11
2.4	Operational Safety	12
2.5	Product Safety	12
<b>3</b>	<b>Product Description</b>	<b>13</b>
3.1	Function	13
<b>4</b>	<b>Incoming Acceptance and Product Identification</b>	<b>14</b>
4.1	Incoming Acceptance	14
4.2	Product Identification	15
4.3	Nameplates	15
4.4	Storage and Transport	17
4.5	Scope of Delivery	17
<b>5</b>	<b>Installation</b>	<b>18</b>
5.1	Installation Instructions	18
5.2	Additional Mounting Instructions	19
5.3	Dimensions	19
5.4	Mounting the Device with a Mounting Clamp	20
5.5	Mounting the Device with a Cable Mounting Screw	21
5.6	Mounting the Terminal Box	22
5.7	Mounting the HUT Temperature Head Transmitter with Terminal Box	22

5.8	Mounting the Terminal Block for the passive Pt100 Resistance Thermometer (without HUT Temperature Head Transmitter) .....	24
5.9	Cable Marking .....	25
5.10	Cable Shortening Kit .....	26
5.11	Post-installation check .....	26
<b>6</b>	<b>Electrical Connection.</b> .....	<b>27</b>
6.1	Connecting the Device .....	27
6.2	Supply voltage .....	30
6.3	Cable Specifications .....	31
6.4	Power Consumption .....	31
6.5	Current Consumption .....	31
6.6	Maximum Load for Device 4 to 20 mA Analog .....	32
6.7	Connecting the Measuring Unit .....	33
6.8	Post-connection check .....	34
<b>7</b>	<b>Operation.</b> .....	<b>35</b>
7.1	Overview of Operation .....	35

# 1 Important Document Information

## 1.1 Document function

These brief instructions contain all the essential information from incoming acceptance to commissioning.

## 1.2 Document Conventions

### 1.2.1 Symbols Used

This document contains symbols for the identification of warning messages and of informative messages.

#### Warning Messages

You will find warning messages, whenever dangers may arise from your actions. It is mandatory that you observe these warning messages for your personal safety and in order to avoid property damage.

Depending on the risk level, the warning messages are displayed in descending order as follows:



#### ***Danger!***

This symbol indicates an imminent danger.

Non-observance will result in personal injury or death.



#### ***Warning!***

This symbol indicates a possible fault or danger.

Non-observance may cause personal injury or serious property damage.



#### ***Caution!***

This symbol indicates a possible fault.

Non-observance could interrupt the device and any connected systems and plants, or result in their complete failure.

#### Informative Symbols



#### ***Note!***

This symbol brings important information to your attention.



#### Action

This symbol indicates a paragraph with instructions. You are prompted to perform an action or a sequence of actions.

## 1.2.2 Electrical symbols







Symbol	Meaning
	<b>Direct current</b> A terminal to which DC voltage is applied or through which direct current flows.
	<b>Alternating current</b> A terminal to which alternating voltage is applied or through which alternating current flows.
	<b>Direct current and alternating current</b> <ul style="list-style-type: none"> <li>• A terminal to which alternating voltage or DC voltage is applied.</li> <li>• A terminal through which alternating current or direct current flows.</li> </ul>
	<b>Ground connection</b> A grounded terminal which, as far as the operator is concerned, is grounded via a grounding system.
	<b>Protective ground connection</b> A terminal which must be connected to ground prior to establishing any other connections.
	<b>Equipotential connection</b> A connection that has to be connected to the plant grounding system: This may be a potential equalization line or a star grounding system depending on national or company codes of practice.

Table 1.1

## 1.2.3 Tool symbols





Symbol	Meaning
	Torx screwdriver
	Flat blade screwdriver
	Cross-head screwdriver
	Allen key
	Hexagon wrench

Table 1.2

## 1.2.4 Symbols for certain types of information





Symbol	Meaning
	<b>Allowed</b> Indicates procedures, processes or actions that are allowed.
	<b>Preferred</b> Indicates procedures, processes or actions that are preferred.
	<b>Forbidden</b> Indicates procedures, processes or actions that are forbidden.
1., 2., 3. ...	Series of steps
	Result of a sequence of actions
	Visual check

Table 1.3

## 1.2.5 Symbols in graphics



Symbol	Meaning
1, 2, 3 ...	Item numbers
	Series of steps
A, B, C, ...	Views
A-A, B-B, C-C, ...	Sections
	<b>Hazardous area</b> Indicates a hazardous area.
	<b>Safe area (non-hazardous area)</b> Indicates a non-hazardous location.

Table 1.4

## 1.3 Documentation

The documents listed are available on the product detail page of the appropriate product.

### 1.3.1 Technical Information (TI)

Planning aid for your device: TI00431O

The document contains all the technical data on the device and provides an overview of the accessories and other products that can be ordered for the device.

### 1.3.2 Brief Instructions (KA)

Getting the 1st measured value quickly: 4 to 20 mA Analog – KA01244O

The brief instructions contain all the essential information from incoming acceptance to initial commissioning.

### 1.3.3 Manual (BA)

Your comprehensive reference: 4 to 20 mA Analog – BA01605O

These manual contain all the information that is required in various phases of the life cycle of the device: from product identification, incoming acceptance and storage, to mounting, connection, operation and commissioning through to troubleshooting, maintenance and disposal.

### 1.3.4 Instruction Manuals (SI)

Depending on the approval, the following instruction manuals (SI) are supplied with the device. They are an integral part of the documentation.

Option <sup>1</sup>	Approval	Documentation
E3	ATEX II 3G Ex nA IIC T6...T4 Gc	SI00485O
EX	ATEX II 2G Ex ia IIC T6...T4 Gb	SI00454O
IC	IEC Ex ia IIC T6...T4 Gb	SI00455O
C1	CSA C/US IS Cl. I Div. 1 Group A-D, Ex ia, Zone 1	ZD00232O
F1	FM IS Cl. I Div. 1 Group A-D, AEx ia, Zone 1	ZD00231O

Table 1.5

<sup>1</sup> See ordering information: product structure, feature "Approval".



#### **Note!**

The nameplate indicates the instruction manuals (SI) that are relevant to the device.



## 1.4 Terms and Abbreviations

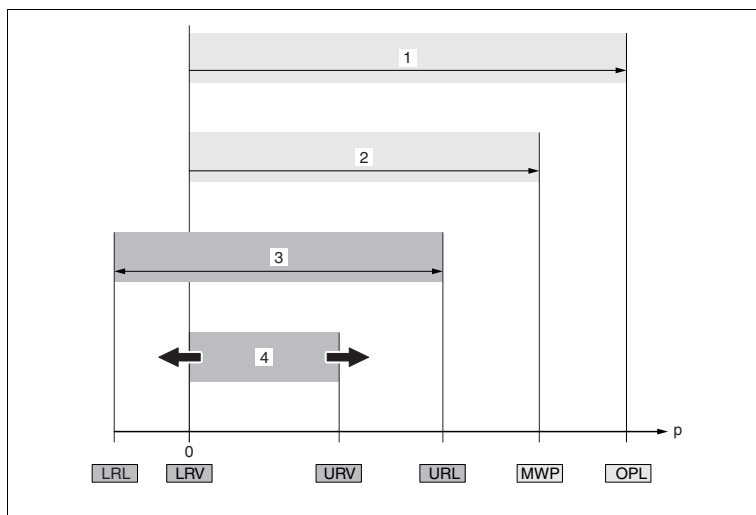

Figure 1.1

Position	Terms/ abbreviations	Explanation
1	OPL	The OPL (over pressure limit = sensor overload limit) for the measuring device depends on the lowest-rated element, with regard to pressure, of the selected components, i. e. the process connection has to be taken into consideration in addition to the measuring cell. Also observe pressure-temperature dependency. For the relevant standards and additional notes, see the "Pressure specifications" section. The OPL may only be applied for a limited period of time.
2	MWP	The MWP (maximum working pressure) for the sensors depends on the lowest-rated element, with regard to pressure, of the selected components, i. e. the process connection has to be taken into consideration in addition to the measuring cell. Also observe pressure-temperature dependency. For the relevant standards and additional notes, see the "Pressure specifications" section. The MWP may be applied at the device for an unlimited period. The MWP can also be found on the nameplate.
3	Maximum sensor measuring range	Span between LRL and URL This sensor measuring range is equivalent to the maximum calibratable/adjustable span.
4	Calibrated/adjusted span	Span between LRV and URV Factory setting: 0 to URL Other calibrated spans can be ordered as customized spans.

Position	Terms/ abbreviations	Explanation
p	–	Pressure
–	LRL	Lower range limit
–	URL	Upper range limit
–	LRV	Lower range value
–	URV	Upper range value
–	TD (Turn down)	Turn down: Example see the following section.
–	PE	Polyethylene
–	FEP	Fluorinated ethylene propylene

Table 1.6

## 1.5 Turn down calculation

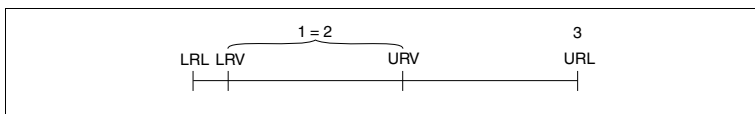

Figure 1.2

- 1 Calibrated/adjusted span
- 2 Zero point-based span (4 to 20 mA analog: customer-specific span can only be set at the factory when ordered)
- 3 Upper range value

### Example

- Sensor: 10 bar (150 psi)
- Upper range value (URL) = 10 bar (150 psi)
- Calibrated/adjusted span: 0 to 5 bar (0 to 75 psi)
- Lower range value (LRV) = 0 bar (0 psi)
- Upper range value (URV) = 5 bar (75 psi)

$$TD = URL / (URV - LRV)$$

$$TD = 10 \text{ bar (150 psi)} / (5 \text{ bar (75 psi)} - 0 \text{ bar (0 psi)}) = 2$$

In this example, the TD is 2:1. This span is based on the zero point.

## 2 Basic Safety Instructions

### 2.1 Requirements for the Personnel

The personnel for installation, commissioning, diagnostics and maintenance must fulfill the following requirements:

- Trained, qualified specialists must have a relevant qualification for this specific function and task
- Are authorized by the plant owner/operator
- Are familiar with federal/national regulations
- Before beginning work, the specialist staff must have read and understood the instructions in the manual and supplementary documentation as well as in the certificates (depending on the application)
- Following instructions and basic conditions.

The operating personnel must fulfill the following requirements:

- Being instructed and authorized according to the requirements of the task by the facility's owner-operator.
- Following the instructions in these manual.

### 2.2 Intended Use

#### 2.2.1 Application and Media

The device is a hydrostatic pressure sensor for measuring the level of fresh water, wastewater and salt water. The temperature is measured simultaneously in the case of sensor versions with a Pt100 resistance thermometer. An optional temperature head transmitter converts the Pt100 signal into a 4 to 20 mA signal.

#### 2.2.2 Incorrect use

The manufacturer is not liable for damage caused by improper or non-designated use.

Verification for borderline cases:

For special fluids and fluids for cleaning, Pepperl+Fuchs is glad to provide assistance in verifying the corrosion resistance of fluid-wetted materials, but does not accept any warranty or liability.

### 2.3 Workplace Safety

For work on and with the device:

- Wear the required personal protective equipment according to federal/national regulations.
- Switch off the supply voltage before connecting the device.

## 2.4 Operational Safety

Risk of injury.

- Operate the device in proper technical condition and fail-safe condition only.
- The operator is responsible for interference-free operation of the device.

### 2.4.1 Modifications to the device

Unauthorized modifications to the device are not permitted and can lead to unforeseeable dangers.

- If, despite this, modifications are required, consult with Pepperl+Fuchs.

### 2.4.2 Repairs

To ensure continued operational safety and reliability,

- Carry out repairs on the device only if they are expressly permitted.
- Observe federal/national regulations pertaining to repair of an electrical device.
- Use original spare parts and accessories from Pepperl+Fuchs only.

### 2.4.3 Hazardous area

To eliminate danger to persons or the facility when the device is used in the approval-related area (e. g. explosion protection, pressure vessel safety):

- Check the nameplate to verify if the device ordered can be put to its intended use in the approval-related area.
- Observe the specifications in the separate supplementary documentation that is an integral part of these manual.

## 2.5 Product Safety

This measuring device is designed in accordance with good engineering practice to meet state-of-the-art safety requirements, has been tested, and left the factory in a condition in which they are safe to operate.

It meets general safety standards and legal requirements. It also complies with the EU directives listed in the device-specific EU Declaration of Conformity. Pepperl+Fuchs confirms this by affixing the CE mark to the device.

### 3 Product Description

#### 3.1 Function

The ceramic measuring cell is a dry measuring cell i. e. the pressure acts directly on the robust, ceramic process isolating diaphragm of the device. Changes in air pressure are guided via a pressure compensation tube through the extension cable to the rear of the ceramic process isolating diaphragm and are compensated for. A pressure-dependent change in capacitance, caused by the movement of the process isolating diaphragm, is measured at the electrodes of the ceramic carrier. The electronics unit then converts this to a signal that is proportional to the pressure and linear to the level.

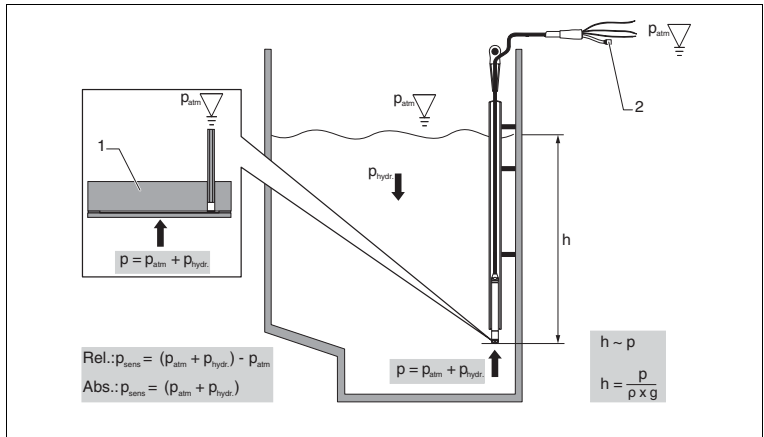

Figure 3.1

- 1 Ceramic measuring cell
- 2 Pressure compensation tube
- h Height level
- p Total pressure = atmospheric pressure + hydrostatic pressure
- r Density of the medium
- g Acceleration due to gravity
- $p_{hydr}$  Hydrostatic pressure
- $p_{atm}$  Atmospheric pressure
- $p_{sens}$  Pressure displayed on the sensor

## 4 Incoming Acceptance and Product Identification

### 4.1 Incoming Acceptance







	
<p>Is the order code on the delivery note (1) identical to the order code on the product sticker (2)?</p>	
	
	
<p>Are the goods undamaged?</p>	
	
<p>Do the data on the nameplates correspond to the order specifications on the delivery note?</p>	
	
<p>Is the documentation available? If required (see nameplate): Are the instruction manuals (SI) present?</p>	

Table 4.1

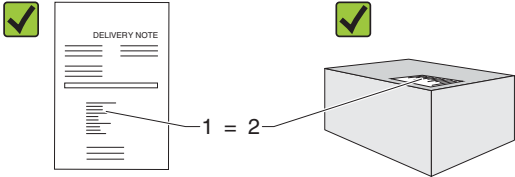
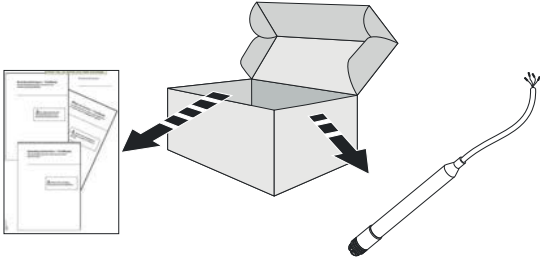
303221 2017-02

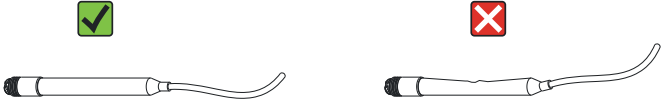

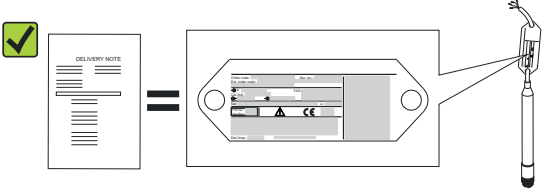
**Note!**

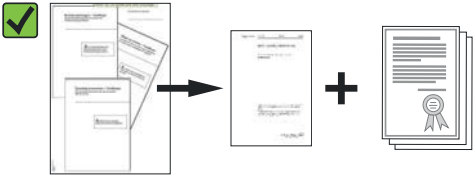
If one of these conditions is not met, please contact your Pepperl+Fuchs sales office.

**4.2 Product Identification**

The following options are available for identification of the measuring device:

- Nameplate data
- Order code with breakdown of the device features on the delivery note
- Scan the 2-D matrix code (QR code) on the nameplate: all the information for the measuring device is displayed.

**4.3 Nameplates**

**4.3.1 Nameplates on probe connection (extension cable)**

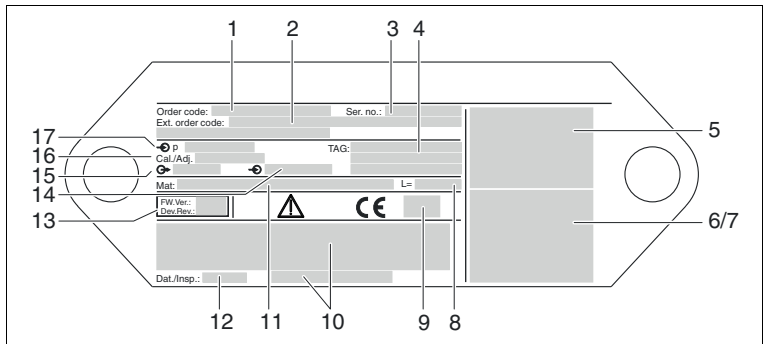

Figure 4.1

- 1 Order code (shortened for reordering); The meaning of the individual letters and digits is explained in the order confirmation details.
- 2 Extended order number (complete)
- 3 Serial number (for clear identification)
- 4 TAG (device tag)
- 5 Device connection diagram
- 6 Pt100 connection diagram (optional)
- 7 Warning (hazardous area), (optional)
- 8 Length of probe connection (extension cable)
- 9 Approval symbol, e. g. CSA, FM, ATEX (optional)
- 10 Text for approval (optional)
- 11 Materials in contact with process
- 12 Test date (optional)
- 13 Device version
- 14 Supply voltage

- 15 Output signal
- 16 Set measuring range
- 17 Nominal measuring range

#### 4.3.2 Additional nameplate for devices with approvals

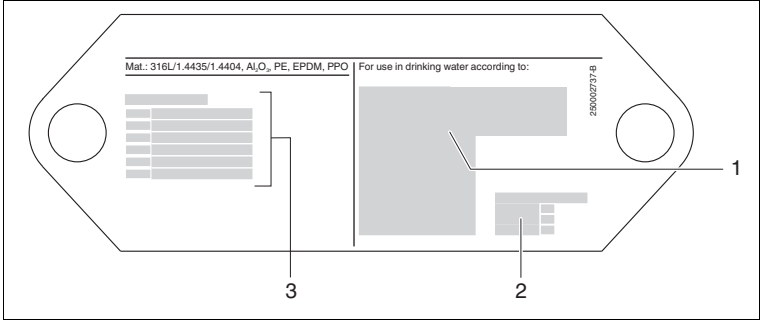

Figure 4.2

- 1 Approval symbol
- 2 Reference to associated documentation
- 3 Approval number

#### 4.3.3 Additional nameplate for devices with external diameter 22 mm (0.87 inch) and 42 mm (1.65 inch)

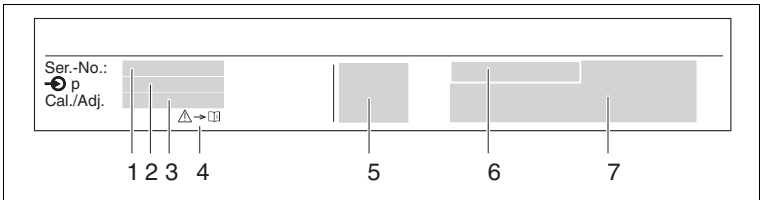

Figure 4.3

- 1 Serial number
- 2 Nominal measuring range
- 3 Set measuring range
- 4 CE mark or approval symbol
- 5 Certificate number (optional)
- 6 Text for approval (optional)
- 7 Reference to documentation



## 4.4 Storage and Transport

### 4.4.1 Storage Conditions

Use original packaging.

Store the measuring device in clean and dry conditions and protect from damage caused by shocks (EN 837-2).

#### Storage Temperature Range

##### Level probe and Pt100 (optional)

-40 to +80 °C (-40 to +176 °F)

##### Probe connection (extension cable)

(when mounted in a fixed position)

- With PE: -30 to +70 °C (-22 to +158 °F)
- With FEP: -30 to +80 °C (-22 to +176 °F)

##### Terminal box

-40 to +80 °C (-40 to +176 °F)

##### HUT temperature head transmitter (optional) for device with 4 to 20 mA Analog

-40 to +100 °C (-40 to +212 °F)

### 4.4.2 Transporting the Product to the Measuring Point



#### **Warning!**

Risk of injury by incorrect transport

Device or cable may become damaged, and there is a risk of injury!

- Transport measuring device in the original packaging.
- Follow the safety instructions and transport conditions for devices weighing more than 18 kg (39.6 lbs).

## 4.5 Scope of Delivery

The scope of delivery comprises:

- Level probe LGC2, optionally with integrated Pt100 resistance thermometer
- Optional accessories

Documentation supplied:

- The BA01605O manual are available on the internet.
- Brief instructions KA01244O
- Final inspection report
- Potable water approvals (optional): SD00289O, SD00319O
- Devices that are suitable for use in hazardous areas: additional documentation e. g. instruction manuals (SI, ZD)

## 5 Installation

### 5.1 Installation Instructions

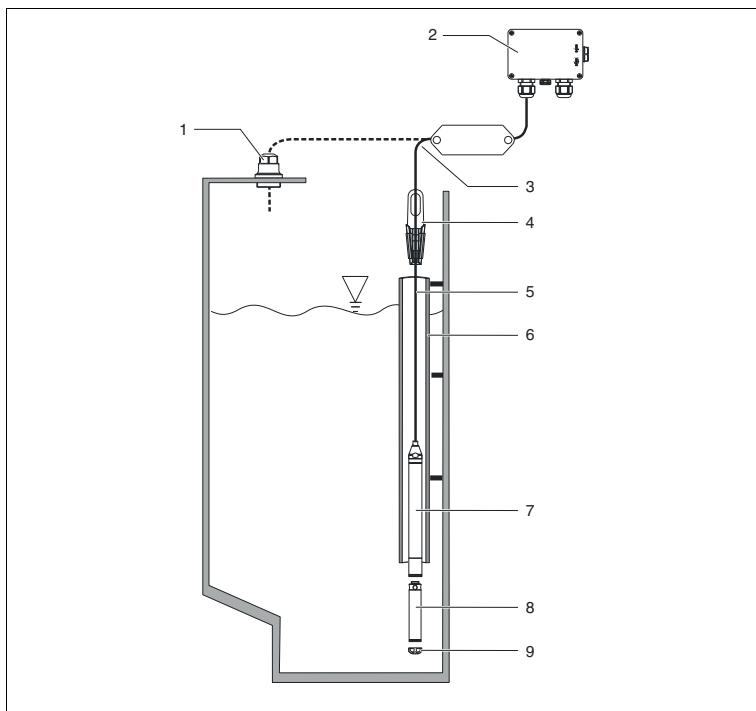

Figure 5.1

- 1 Cable mounting screw can be ordered as an accessory
- 2 Terminal box can be ordered as an accessory
- 3 Bending radius of extension cable > 120 mm (4.72 inch)
- 4 Mounting clamp can be ordered as an accessory
- 5 Probe connection (extension cable), cable length
- 6 Guide tube
- 7 Level probe LGC
- 8 Additional weight can be ordered as an accessory for the level probe with external diameter of 22 mm (0.87 inch) and 29 mm (1.14 inch)
- 9 Protection cap

## 5.2 Additional Mounting Instructions

- Cable length
  - Customer-specific in meters or feet
  - Limited cable length when performing installation with freely suspended device with cable mounting screw or mounting clamp, as well as for Ex approval: max. 300 m (984 foot).
- Sideways movement of the level probe can result in measuring errors. For this reason, install the probe at a point free from flow and turbulence, or use a guide tube. The internal diameter of the guide tube should be at least 1 mm (0.04 inch) greater than the external diameter of the selected device.
- To avoid mechanical damage to the measuring cell, the device is equipped with a protection cap.
- The cable must end in a dry room or a suitable terminal box. The terminal box from Pepperl+Fuchs provides humidity and climatic protection and is suitable for installation outdoors.
- Cable length tolerance: < 5 m (16 foot):  $\pm 17.5$  mm (0.69 inch); > 5 m (16 foot):  $\pm 0.2$  %
- If the cable is shortened, the filter at the pressure compensation tube must be reattached. Pepperl+Fuchs offers a cable shortening kit for this purpose.
- Pepperl+Fuchs recommends using twisted, shielded cable.
- In shipbuilding applications, measures are required to restrict the spread of fire along cable looms.
- The length of the extension cable depends on the intended level zero point. The height of the protection cap must be taken into consideration when designing the layout of the measuring point. The level zero point (E) corresponds to the position of the process isolating diaphragm. Level zero point = E; tip of probe = L (see the following diagram).

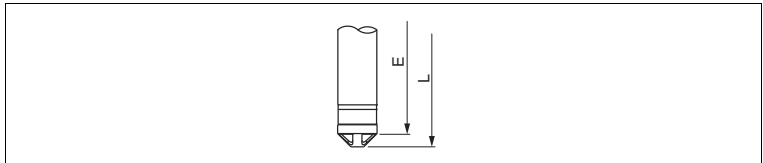

Figure 5.2

## 5.3 Dimensions

For dimensions, please refer to the Technical Information TI004310, "Mechanical Construction" chapter, see chapter 1.3.

## 5.4 Mounting the Device with a Mounting Clamp

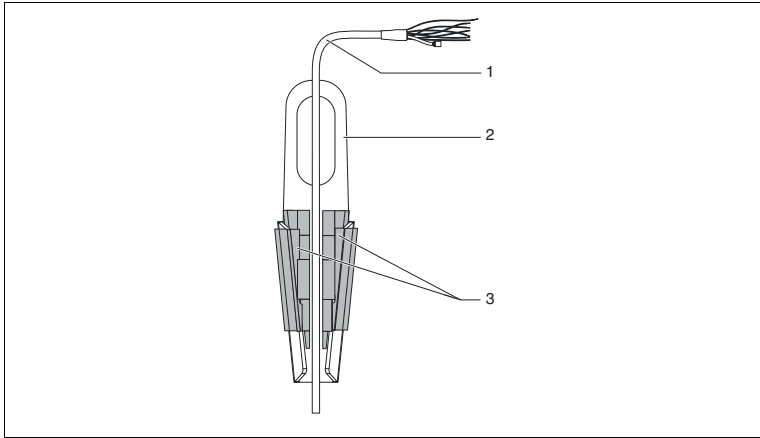

Figure 5.3

- 1 Probe connection (extension cable)
- 2 Suspension clamp
- 3 Clamping jaws



### Mounting the Suspension Clamp

1. Mount the suspension clamp (2). Take the weight of the extension cable (1) and the device into account when selecting the fastening point.
2. Push up the clamping jaws (3). Place the extension cable (1) between the clamping jaws as shown in the diagram.
3. Hold the extension cable (1) in position and push the clamping jaws (3) back down. Tap the clamping jaws gently from above to fix them in place.

## 5.5 Mounting the Device with a Cable Mounting Screw

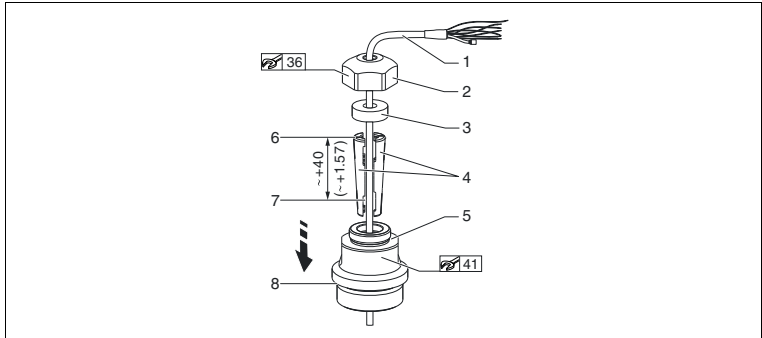

Figure 5.4

- 1 Probe connection (extension cable)
- 2 Cover for cable mounting screw
- 3 Sealing ring
- 4 Clamping sleeves
- 5 Adapter for cable mounting screw
- 6 Top edge of clamping sleeve
- 7 Desired length of extension cable and device probe prior to assembly
- 8 After assembly, item 7 is located next to the mounting screw with G1-1/2 thread: height of sealing surface of the adapter or NPT1-1/2 thread height of thread run-out of adapter  
Engineering unit mm (inch). Illustrated with G1-1/2 thread.



### **Note!**

If you want to lower the level probe to a certain depth, position the top edge of the clamping sleeve 40 mm (4.57 inch) higher than the required depth. Then push the extension cable and the clamping sleeve into the adapter as described in step 6 in the following action.



### Mounting the Cable Mounting Screw with a G1-1/2 or NPT1-1/2 Thread

1. Mark the desired length of extension cable on the extension cable.
2. Insert the probe through the measuring aperture and carefully lower on the extension cable. Fix the extension cable to prevent it from slipping.
3. Slide the adapter (5) over the extension cable and screw it tightly into the measuring aperture.
4. Slide the sealing ring (3) and cover (2) onto the cable from above. Press the sealing ring into the cover.
5. Place the clamping sleeves (4) around the extension cable (1) at the marked point as illustrated in the graphic.
6. Slide the extension cable with the clamping sleeves (4) into the adapter (5)

- Fit the cover (2) with the sealing ring (3) onto the adapter (5) and securely screw together with the adapter.



**Note!**

To remove the cable mounting screw, perform this sequence of steps in reverse.



**Warning!**

Risk of injury from working on containers

Installation works on containers under pressure can result in injuries.

Only mount the device with cable mounting screw in unpressurized containers.

## 5.6 Mounting the Terminal Box

The optional terminal box is mounted using four screws (M4).

## 5.7 Mounting the HUT Temperature Head Transmitter with Terminal Box

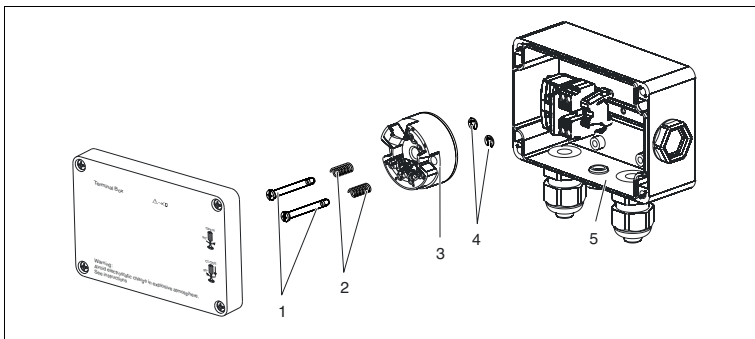

Figure 5.5

- Mounting screws
- Mounting springs
- HUT temperature head transmitter
- Circlips
- Terminal box



**Note!**

Only open the terminal box with a screwdriver.



**Warning!**

Explosion hazard when using the temperature head transmitter

The usage of temperature head transmitter in the hazardous area can result in explosion.

Do not use the HUT temperature head transmitter in the hazardous area.



**Mounting the Temperature Head Transmitter**

1. Guide the mounting screws (1) with the mounting springs (2) through the bore of the temperature head transmitter (3).
2. Secure the mounting screws with the circlips (4). Circlips, mounting screws and springs are included in the scope of delivery for the temperature head transmitter.
3. Screw the temperature head transmitter into the field housing tightly. (Width of screwdriver blade max. 6 mm 0.24 inch).



**Warning!**

Property damage from wrong mounting

If you tighten the mounting screws too tightly, this can damage the temperature head transmitter.

Do not overtighten the mounting screw too.

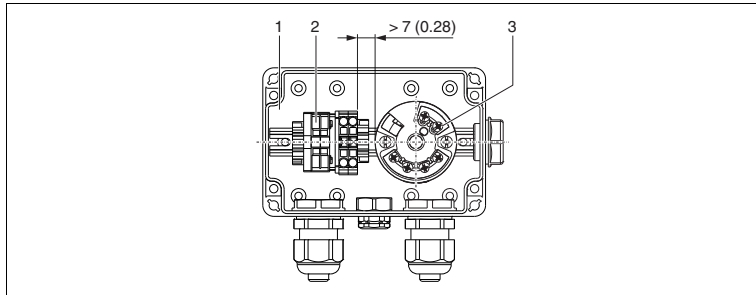

Figure 5.6

- 1 Terminal box
- 2 Terminal block/terminals
- 3 Temperature head transmitter HUT

Measuring unit mm (inch)



**Warning!**

Property damage from wrong mounting

If the distance between the terminal block and the temperature head transmitter is too small, this can result in damage of the components.

Maintain a distance of  $> 7 \text{ mm}$  ( $> 0.28 \text{ inch}$ ) between the terminal block and the HUT temperature head transmitter.

## 5.8 Mounting the Terminal Block for the passive Pt100 Resistance Thermometer (without HUT Temperature Head Transmitter)

If the device with optional Pt100 resistance thermometer is supplied without the optional HUT temperature head transmitter, a terminal block is provided with the terminal box for the purpose of wiring the Pt100 resistance thermometer.



**Warning!**

Explosion hazard when using the resistance thermometer

The usage of resistance thermometer in the hazardous area can result in explosion.

Do not use the resistance thermometer and the terminal block in the hazardous area.

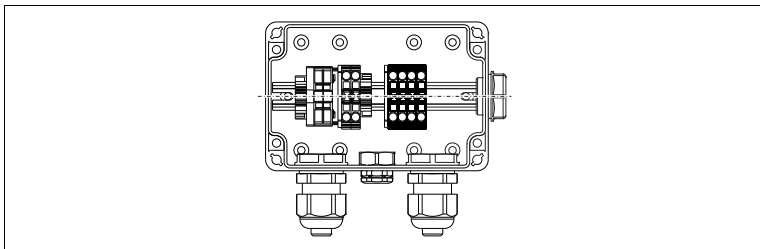

Figure 5.7



## 5.9 Cable Marking

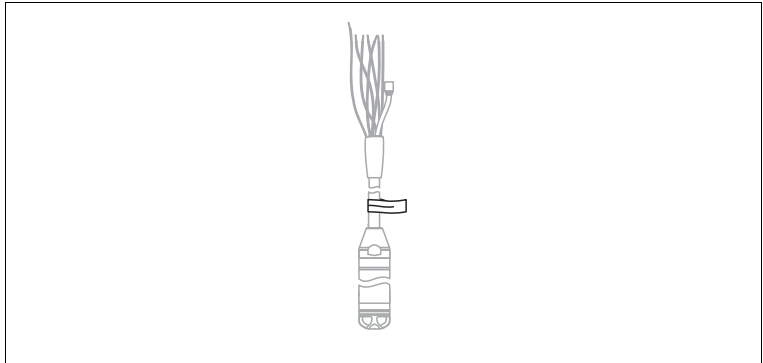

Figure 5.8

- To make installation easier, Pepperl+Fuchs marks the extension cable if a customer specific length has been ordered.  
Ordering information: product structure, feature "Service", option "RI" or "SI".
- Cable marking tolerance (distance to lower end of level probe):  
Cable length < 5 m (16 foot):  $\pm 17.5$  mm (0.69 inch)  
Cable length > 5 m (16 foot):  $\pm 0.2$  %
- Material: PET, stick-on label: acrylic
- Immunity to temperature change: -30 to +100 °C (-22 to +212 °F)



**Note!**

The marking is used exclusively for installation purposes. The mark must be thoroughly removed without trace in the case of devices with drinking water approval. The extension cable must not be damaged in the process.



**Note!**

Not for use of the device in hazardous areas.

## 5.10 Cable Shortening Kit

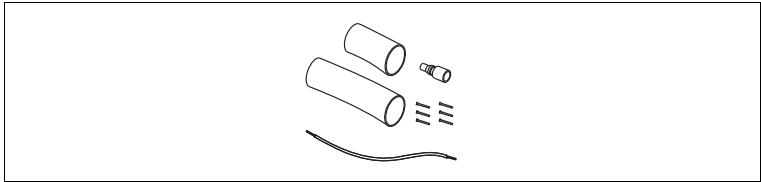

Figure 5.9

The cable shortening kit is used to shorten a cable easily and professionally.  
Ordering information: product structure, feature "Accessories", option "WP"



### **Note!**

The cable shortening kit is not designed for the device with FM/CSA approval.

## 5.11 Post-installation check

- Is the device undamaged (visual inspection)?
- Does the device conform to the measuring point specifications?  
For example:
  - Process temperature
  - Process pressure
  - Ambient temperature
  - Measuring range
- Are the measuring point identification and labeling correct (visual inspection)?
- Are the securing screws tightened securely?

## 6 Electrical Connection



### **Warning!**

Danger to life from wrong electrical connection

Incorrect electrical connection of the device can compromise its function and its electrical safety.

When using the measuring device in a hazardous area, the relevant national standards and guidelines as well as the instruction manuals (SI) or installation or control drawings (ZD) must be adhered to. All data relating to explosion protection can be found in separate documentation which is available on request. This documentation is supplied with the devices as standard, see chapter 1.3.

### 6.1 Connecting the Device



### **Warning!**

Danger to life from wrong electrical connection

Incorrect electrical connection of the device can compromise its function and its electrical safety.

- The supply voltage must match the supply voltage specified on the nameplate, see chapter 4.
- Switch off the supply voltage before connecting the device.
- The cable must end in a dry room or a suitable terminal box. The IP66/IP67 terminal box with GORE-TEX® filter is suitable for outdoor installation, see chapter 5.
- Connect the device in accordance with the following diagrams. Reverse polarity protection is integrated into the device and the temperature head transmitter. Changing the polarities will not result in the destruction of the devices.
- A suitable circuit breaker should be provided for the device in accordance with IEC/EN 61010.

### 6.1.1 Level probe and Pt100 Resistance Thermometer

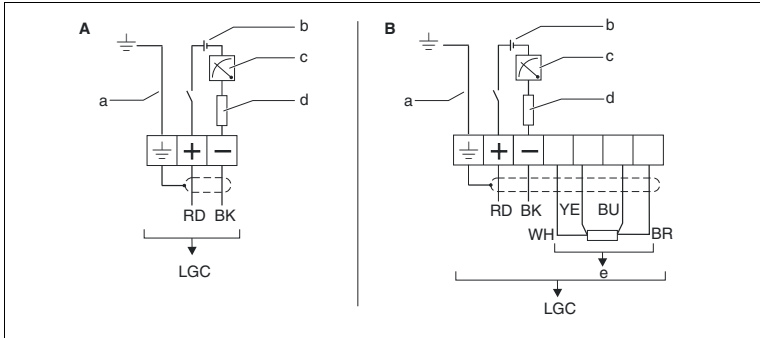

Figure 6.1

- A** Level probe LGC
- B** Level probe and Pt100 resistance thermometer (not for use in hazardous areas), ordering information, feature "Accessories", option "BN"
- a** Not for the level probe with external diameter of 29 mm (1.14 inch)
- b** 10.5 to 30 V DC (hazardous area), 10.5 to 35 V DC
- c** 4 to 20 mA
- d** Resistance ( $R_L$ )
- e** Pt100 resistance thermometer

### 6.1.2 Level Probe with Pt100 Resistance Thermometer and HUT Temperature Head Transmitter for Device with 4 to 20 mA Analog

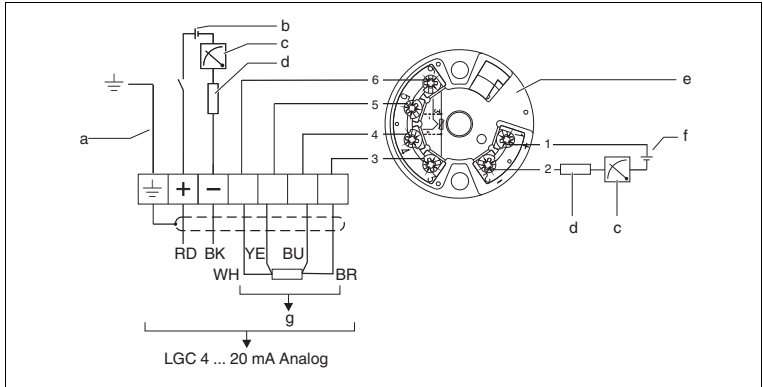

Figure 6.2

- a Not for the level probe with external diameter of 29 mm (1.14 inch)
- b 10.5 to 35 V DC
- c 4 to 20 mA
- d Resistance ( $R_t$ )
- e Temperature head transmitter HUT (4 to 20 mA) (not for use in hazardous area)
- f 8 to 35 V DC
- g Pt100 resistance thermometer
- 1 t Terminal assignment
- o
- 6

Ordering information:

Pt100 resistance thermometer: product structure, feature "Accessories", option "BN".

HUT temperature head transmitter: product structure, feature "Accessories", option "XP"

### 6.1.3 Wire Colors

RD = red, BK = black, WH = white, YE = yellow, BU = blue, BR = brown

### 6.1.4 Connection Data

Connection classification as per IEC 61010-1:

- Overvoltage category 1
- Pollution level 1

#### Connection Data in the Hazardous Area

See relevant instruction manuals (SI, ZD).

## 6.2 Supply voltage



#### **Danger!**

Explosion hazard from live wiring of circuits

If you connect or disconnect energized circuits in a potentially explosive atmosphere, sparks can ignite the surrounding atmosphere.

Only connect or disconnect energized circuits in the absence of a potentially explosive atmosphere.



#### **Danger!**

Danger to life from electric shock

Working on live parts at voltages higher than 50 V AC or 120 V DC can result in electric shock.

1. De-energize the device.
2. Secure the circuit against reconnection.
3. Verify that the device is de-energized at all poles.
4. Provide protection from adjacent live parts, if present.



#### **Note!**

When using the measuring device in hazardous areas, installation must comply with the corresponding national standards and regulations and the instruction manuals or installation or control drawings (SI, ZD).

### 6.2.1 Level probe and Pt100 (optional)

- 10.5 to 35 V DC (non-hazardous areas)
- 10.5 to 30 V DC (hazardous areas)

### 6.2.2 HUT temperature head transmitter (optional) for device with 4 to 20 mA Analog

8 to 35 V DC

## 6.3 Cable Specifications

Pepperl+Fuchs recommends using shielded, twisted-pair two-wire cables.



### **Note!**

The probe cables are shielded for device versions with outer diameters of 22 mm (0.87 inch) and 42 mm (1.65 inch).

### 6.3.1 Level probe and Pt100 (optional)

- Commercially available instrument cable
- Terminals, terminal box: 0.08 to 2.5 mm<sup>2</sup> (28 to 14 AWG)

### 6.3.2 HUT Temperature Head Transmitter (optional) for Device with 4 to 20 mA Analog

- Commercially available instrument cable
- Terminals, terminal box: 0.08 to 2.5 mm<sup>2</sup> (28 to 14 AWG)
- Transmitter connection: max. 1.75 mm<sup>2</sup> (15 AWG)

## 6.4 Power Consumption

### 6.4.1 Level probe and Pt100 (optional)

- $\leq 0.805$  W at 35 V DC (non-hazardous areas)
- $\leq 0.690$  W at 30 V DC (hazardous areas)

### 6.4.2 HUT Temperature Head Transmitter (optional) for Device with 4 to 20 mA Analog

$\leq 0.875$  W at 35 V DC

## 6.5 Current Consumption

### 6.5.1 Level probe and Pt100 (optional)

- Max. current consumption:  $\leq 23$  mA
- Min. current consumption:  $\geq 3.6$  mA

### 6.5.2 HUT Temperature Head Transmitter (optional) for Device with 4 to 20 mA Analog

- Max. current consumption:  $\leq 25$  mA
- Min. current consumption:  $\geq 3.5$  mA

## 6.6 Maximum Load for Device 4 to 20 mA Analog

The maximum load resistance depends on the supply voltage (U) and must be determined individually for each current loop, see formula and diagrams for device and temperature head transmitter. The total resistance resulting from the resistances of the connected devices, the connecting cable and, where applicable, the resistance of the process connection may not exceed the load resistance value.

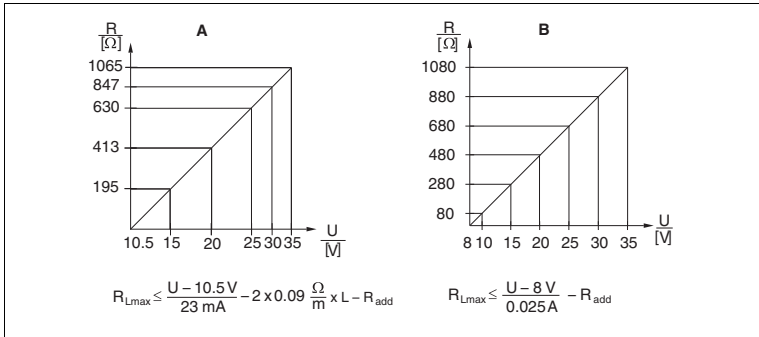

Figure 6.3

- A** Load diagram of the device for estimating the load resistance. Additional resistances, such as the resistance of the extension cable, have to be subtracted from the value calculated as shown in the equation.
- B** Load diagram for HUT temperature head transmitter for estimating the load resistance. Additional resistances must be subtracted from the value calculated as shown in the equation.

**$R_{Lmax}$**  Max. load resistance [Ω]

**$R_{add}$**  Additional resistances such as resistance of evaluating device and/or display unit, cable resistance [Ω]

**U** Supply voltage [V]

**L** Basic length of probe connection [m] (cable resistance per wire  $\leq 0.09 \Omega/m$ )



### Note!

When using the measuring device in hazardous areas, installation must comply with the corresponding national standards and regulations and the instruction manuals or installation or control drawings (SI, ZD).



## 6.7 Connecting the Measuring Unit

### 6.7.1 Overvoltage Protection

To protect the device and the temperature head transmitter from large interference voltage peaks, Pepperl+Fuchs recommends installing overvoltage protection upstream and downstream of the display and/or evaluation unit as shown in the graphic.

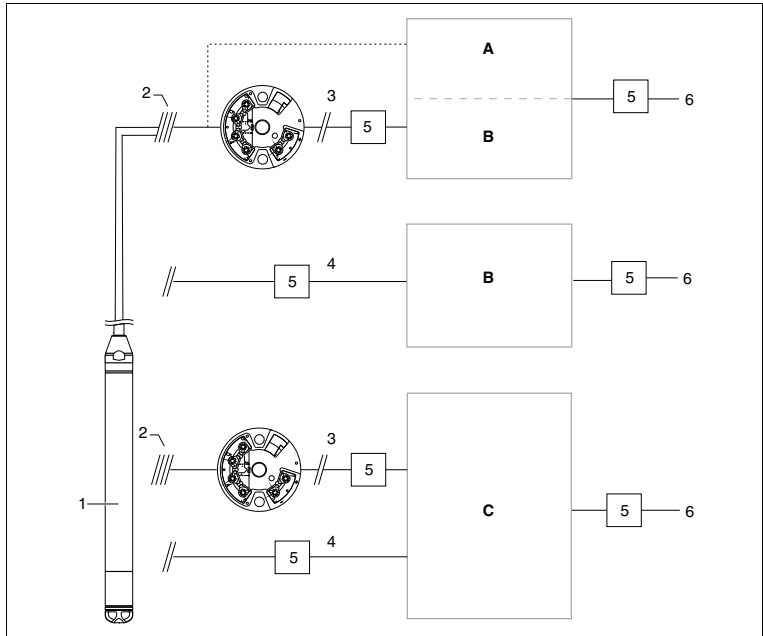

Figure 6.4

- A** Power supply, display and evaluation unit with one input for Pt100 resistance thermometer
- B** Power supply, display and evaluation unit with one input for 4 to 20 mA
- C** Power supply, display and evaluation unit with two inputs for 4 to 20 mA
- 1** Level probe LGC2
- 2** Connection for integrated Pt100 resistance thermometer in the device
- 3** 4 to 20 mA (temperature)
- 4** 4 to 20 mA (level)
- 5** Overvoltage protection, not for use in hazardous areas
- 6** Power supply

## 6.8

### Post-connection check

- Are cables or the device undamaged (visual inspection)?
- Do the cables comply with the requirements?
- Do the cables have adequate strain relief?
- Are all cable glands installed, firmly tightened and correctly sealed?
- Does the supply voltage match the specifications on the transmitter nameplate?
- Is the terminal assignment correct?

## 7 Operation

Pepperl+Fuchs offers comprehensive measuring point solutions with display and/or evaluation units for the device and the HUT temperature head transmitter.



### **Note!**

Your Pepperl+Fuchs service organization would be glad to be of service if you have any other questions. Contact addresses can be found on the website at [www.pepperl-fuchs.com](http://www.pepperl-fuchs.com).

### 7.1 Overview of Operation

No display or other operation facility is required to operate the device.

# PROCESS AUTOMATION – PROTECTING YOUR PROCESS



## Worldwide Headquarters

Pepperl+Fuchs GmbH  
68307 Mannheim · Germany  
Tel. +49 621 776-0  
E-mail: [info@de.pepperl-fuchs.com](mailto:info@de.pepperl-fuchs.com)

For the Pepperl+Fuchs representative  
closest to you check [www.pepperl-fuchs.com/contact](http://www.pepperl-fuchs.com/contact)

[www.pepperl-fuchs.com](http://www.pepperl-fuchs.com)

Subject to modifications  
Copyright PEPPERL+FUCHS • Printed in Germany



71342939

KA012440/98/EN/01.16

 **PEPPERL+FUCHS**  
*PROTECTING YOUR PROCESS*

303221

DOCT-5519  
02/2017