

IDM-Z1-160-D-1D-J1-SU-N-N0
IDM-Z1-160-D-1D-J1-SU-P-N0
IDM-Z1-260-D-2D-J1-S1-N-N0

**Wired handheld scanner for
use in explosion-hazardous
areas Zone 1/21**

Manual



With regard to the supply of products, the current issue of the following document is applicable: The General Terms of Delivery for Products and Services of the Electrical Industry, published by the Central Association of the Electrical Industry (Zentralverband Elektrotechnik und Elektroindustrie (ZVEI) e.V.) in its most recent version as well as the supplementary clause: "Expanded reservation of proprietorship"

Worldwide

Pepperl+Fuchs Group
Lilienthalstr. 200
68307 Mannheim
Germany
Phone: +49 621 776 - 0
E-mail: info@de.pepperl-fuchs.com

North American Headquarters

Pepperl+Fuchs Inc.
1600 Enterprise Parkway
Twinsburg, Ohio 44087
USA
Phone: +1 330 425-3555
E-mail: sales@us.pepperl-fuchs.com

Asia Headquarters

Pepperl+Fuchs Pte. Ltd.
P+F Building
18 Ayer Rajah Crescent
Singapore 139942
Phone: +65 6779-9091
E-mail: sales@sg.pepperl-fuchs.com
<https://www.pepperl-fuchs.com>

1	Safety	4
1.1	Introduction	4
1.1.1	Content of this Document	4
1.1.2	Manufacturer	4
1.1.3	Target Group, Personnel	4
1.1.4	Symbols Used	5
2	Technical Specifications	6
2.1	Explosion protection	6
2.2	Technical Data: Handheld Scanner	7
2.3	Use	7
3	System Structure	8
3.1	Overview	8
3.2	IDM-Z1-160-D-1D-J1-* System Structure 1	10
3.3	IDM-Z1-160-D-1D-J1-* System Structure 2	11
3.4	IDM-Z1-160-D-1D-J1-* System Structure 3	12
3.5	IDM-Z1-260-D-2D-J1-S1-N-N0 System Structure 1	13
3.6	IDM-Z1-260-D-2D-J1-S1-N-N0 System Structure 2	13
3.7	IDM-Z1-260-D-2D-J1-S1-N-N0 System Structure 3	14
4	Commissioning	16
4.1	Connection of the Wired Handheld Scanners	16
4.2	Supply Module Connection	16
4.3	Base connection line RS232	18
4.4	Base connection line USB	19
5	Accessories	21

1 Safety

1.1 Introduction

1.1.1 Content of this Document

This document contains information required to use the product in the relevant phases of the product life cycle. This may include information on the following:

- Product identification
- Delivery, transport, and storage
- Mounting and installation
- Commissioning and operation
- Maintenance and repair
- Troubleshooting
- Dismounting
- Disposal



Note

For full information on the product, refer to the further documentation on the Internet at www.pepperl-fuchs.com.

The documentation comprises the following parts:

- This document
- Datasheet

In addition, the documentation may comprise the following parts, if applicable:

- EU-type examination certificate
- EU declaration of conformity
- Attestation of conformity
- Certificates
- Control drawings
- Instruction manual
- Other documents

1.1.2 Manufacturer

Pepperl+Fuchs Group Lilienthalstraße 200, 68307 Mannheim, Germany
--

Internet: www.pepperl-fuchs.com
--

1.1.3 Target Group, Personnel

Responsibility for planning, assembly, commissioning, operation, maintenance, and dismantling lies with the plant operator.

Only appropriately trained and qualified personnel may carry out mounting, installation, commissioning, operation, maintenance, and dismantling of the product. The personnel must have read and understood the instruction manual and the further documentation.

Prior to using the product make yourself familiar with it. Read the document carefully.

1.1.4 Symbols Used

This document contains symbols for the identification of warning messages and of informative messages.

Warning Messages

You will find warning messages, whenever dangers may arise from your actions. It is mandatory that you observe these warning messages for your personal safety and in order to avoid property damage.

Depending on the risk level, the warning messages are displayed in descending order as follows:



Danger!

This symbol indicates an imminent danger.

Non-observance will result in personal injury or death.



Warning!

This symbol indicates a possible fault or danger.

Non-observance may cause personal injury or serious property damage.



Caution!

This symbol indicates a possible fault.

Non-observance could interrupt the device and any connected systems and plants, or result in their complete failure.

Informative Symbols



Note

This symbol brings important information to your attention.



Action

This symbol indicates a paragraph with instructions. You are prompted to perform an action or a sequence of actions.

2 Technical Specifications

2.1 Explosion protection



IDM-Z1-160-D-1D-J1-*

⊕ Ex II 2G Ex ib IIC T4 Gb

⊕ Ex II 2D Ex ib IIIC T135°C Db

IDM-Z1-260-D-2D-J1-*

⊕ Ex II 2G Ex ib op is IIB T4 Gb

⊕ Ex II 2D Ex ib op is IIIC T135°C Db

Test certificate

IBExU 18ATEX1049

IECEX IBE 18.0008

Manufacturer

Pepperl+Fuchs Group

Lilienthalstraße 200, 68307 Mannheim, Deutschland

info@de.pepperl-fuchs.com

2019-12

2.2 Technical Data: Handheld Scanner

	IDM-Z1-160-D-1D-J1-SU-N-N0	IDM-Z1-160-D-1D-J1-SU-P-N0	IDM-Z1-260-D-2D-J1-S1-N-N0
Description	Linear imager		2-D imager
Barcode	One-dimensional 1-D (barcode)	One-dimensional 1-D (Barcode and stack code incl. PDF417)	One-dimensional 1-D & 2-D (Barcode and stack code incl. PDF417)
Barcode types	Code 39, Code 39 Trioptic, Code 32, Code 93, Code 11, Codabar, Code 128, GS1-128 / EAN 128, UPC / EAN / JAN (with addition), MSI/Plessey, UK/Plessey, IATA, Interleaved 2 of 5, Standard and Industrial 2 of 5, Matrix 2 of 5, Telepen, GS1 DataBar, Australian Post, China Post, German Post, US Planet, US Postnet, British Post, Intelligent Mail, Japan Post, Korean Post, Dutch KIX Post		
Stack codes	-	PDF417, MicroPDF417, Code 49, Code 16K, Composite, Codablock F	
2-D code types	-		Data Matrix, QR-Code, MicroQR-Code, Aztec, MaxiCode
Light source	LED, visible red light, 630 nm		
Scan frequency	500 Hz		60 Hz
Reading distance	20 mm to 850 mm		30 mm to 400 mm
Code resolution (code-dependent)	Approx. ≥ 0.076 mm		Approx. ≥ 0.13 mm
Immunity to extraneous light	100,000 lx		
Electrical data			
Interfaces	RS232 / RS422 / USB		RS232 / USB
Feedback			
Visual	2x LED (operating state/read confirmation)		
Acoustic	Beeper / buzzer (can be switched off)		
Ambient conditions			
Shock resistance	50 drop tests on concrete from a height of 2 m		
Operating temperature	-20 °C to +50 °C		
Storage temperature	-30 °C to +70 °C		-40 °C to +70 °C
Relative humidity	95 % non-condensing		
Mechanical data			
Degree of protection	IP65		
Dimensions [W x H x D]	104 mm x 185 mm x 76 mm		
Weight	Approx. 200 g without connection cable		

2.3 Use

The handheld scanner is a piece of handheld apparatus.

It enables portable recording and direct data transfer in explosion-hazardous areas. The device is specifically modified for use in explosion-hazardous areas of zone 1 and zone 21.

3 System Structure

3.1 Overview

The wired handheld scanners and their accessories are presented in the following overview. The handheld scanners can be connected to a Pepperl+Fuchs VisuNet operator workstation. Connection can be either via the external power module or an integrated barrier (applies to VisuNet GXP). The data can be transferred via the network interface of the VisuNet operator workstation to a host PC in the safe area.

Alternatively, the handheld scanners can be connected to a PC or a programmable logic controller (PLC) with the associated power module and operated as "standalone" units.

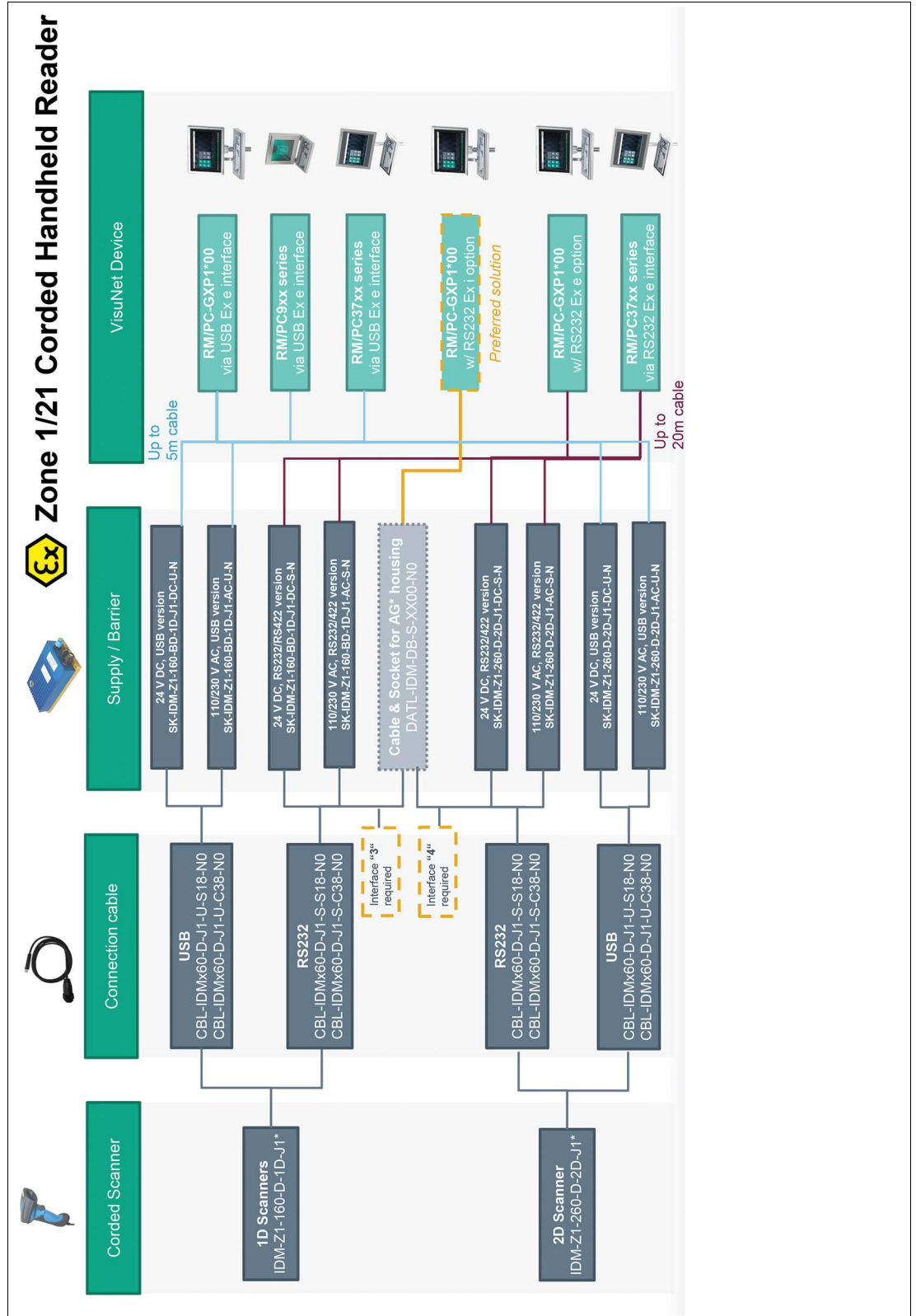

Figure 3.1 Corded scanners and accessories



Warning!

Wired handheld scanners may only be operated with the specified Pepperl+Fuchs connection cables!

Handheld scanners may only be operated on the specified Pepperl+Fuchs supply modules/barriers!

The warning messages in this instruction manual and the SICK AG manual (www.SICK.com) must be observed!

In the following two subchapters, the typical usage cases are described in more detail.

3.2 IDM-Z1-160-D-1D-J1-* System Structure 1

Overview of the complete system structure 1: Wired 1-D handheld scanner IDM-Z1-160-D-1D-J1-SU-N-N0 and IDM-Z1-160-D-1D-J1-SU-P-N0 connected to the power module and the USB Ex i interface of the VisuNet GXP.

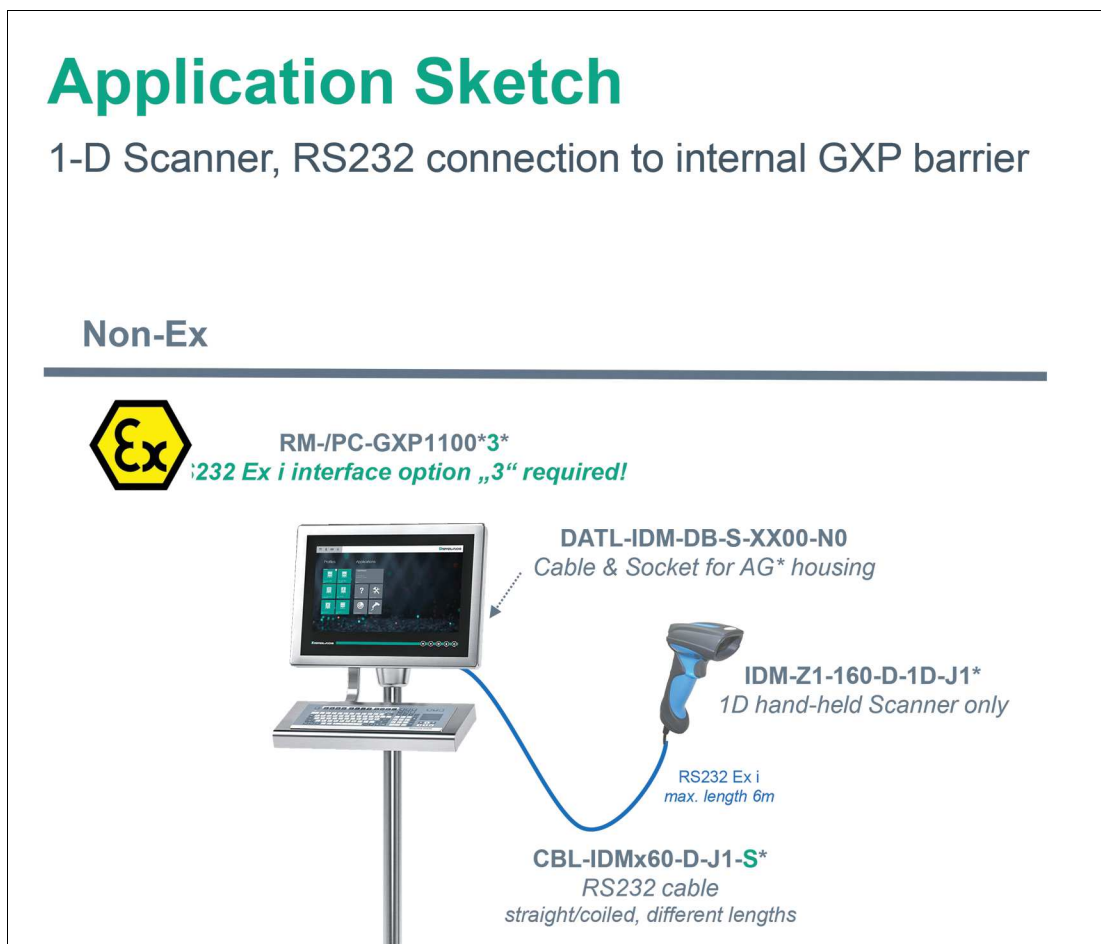

Figure 3.2 System structure 1 – 1-D handheld scanner connected to RS232 Ex i VisuNet GXP interface

Description:

The handheld scanner is designed to be used in explosion-hazardous areas. For proper operation in explosion-hazardous areas, the permissible RS232 cordsets CBL-IDMx60-D-J1-S* must be used. The intrinsically safe power supply and data transfer is realized via this cable. An accessory cable DATL-IDM-DB-S-XX00-N0 is required for a connection to the VisuNet GXP in the AG-XX00 housing. This provides the housing feedthrough and has a connection socket that fits the scanner connection cable.

2019-12



Note

The installation of IDM-Z1-160-D-1D-J1* Barcode Readers to the integrated barrier of the VisuNet GXP or VisuNet IXD requires the optional interface "3". Please refer to the VisuNet GXP and VisuNet IXD Datasheets (Module A and B) for further information regarding the interfaces.

3.3

IDM-Z1-160-D-1D-J1-* System Structure 2

Overview of the complete system structure 2: Wired 1-D handheld scanner IDM-Z1-160-D-1D-J1-SU-N-N0 and IDM-Z1-160-D-1D-J1-SU-P-N0 connected via supply module SK-IDM-Z1-* to the VisuNet GXP in the hazardous environment. The power supply for the supply module is in this application located in the safe area.

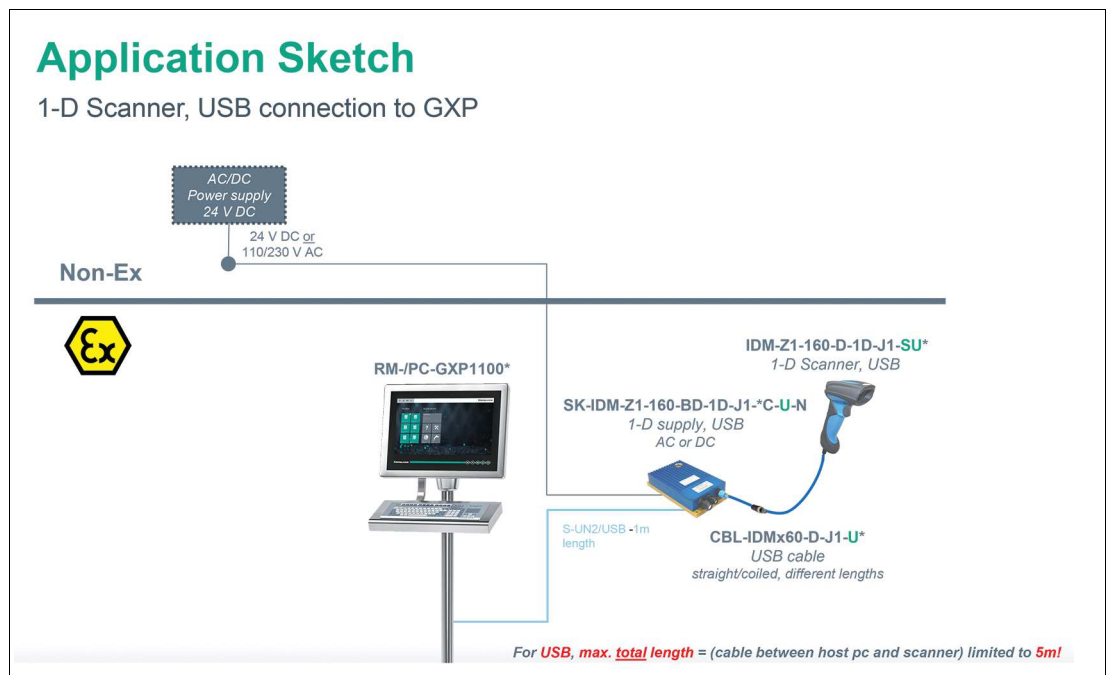

Figure 3.3 System structure 2 - 1-D handheld scanner connected to the supply module and the USB Ex e standard interface of the VisuNet GXP

Description:

The handheld scanner is designed to be used in explosion-hazardous areas. For proper operation in explosion-hazardous areas, the permissible USB cordsets CBL-IDMx60-D-J1-U* must be used. The intrinsically safe power supply and data transfer is realized via this cable. The connection in this structure uses the supply module SK-IDM-Z1-160-BD-1D-J1-*C-U-N0, which is connected to the USB Ex e interface of the VisuNet GXP or another VisuNet operator workstation. Data communication is via the USB Ex e interface, while the handheld scanner is powered by the supply module and the external power supply is located in the Non-Ex environment.

The handheld scanner and the supply module may be connected and used in explosion-hazardous areas. The current rating of the connection line must be observed.



Note

With the USB-interface version, the maximum total cable length between the host - e.g., VisuNet GXP or host PC in the safe area - and the handheld scanner is limited to 5 m! This includes the scanner cable CBL-IDMx60-D-J1-U*.



Note

This setup is also available for RS232. The maximum total cable length between the host and the handheld scanner is then 20 m. Make sure to use the compatible RS232 cables.

3.4 IDM-Z1-160-D-1D-J1-* System Structure 3

Overview of the complete system structure 3: Wired 1-D handheld scanner IDM-Z1-160-D-1D-J1-SU-N-N0 and IDM-Z1-160-D-1D-J1-SU-P-N0 connected to the supply module and a host PC in the safe area.

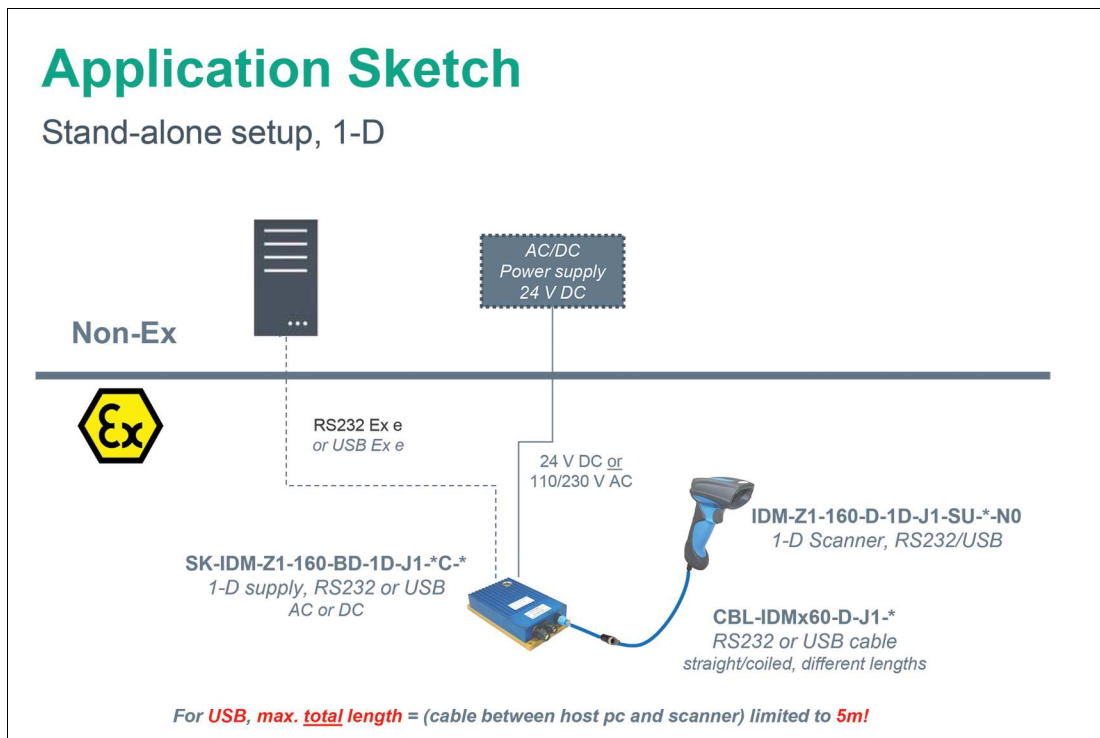

Figure 3.4 System structure 3 - 1-D scanner connected to supply module and host PC in the safe area



Note

The Supply module is available for RS232 and USB, make sure to use the compatible RS232 or USB cables.

Description:

The handheld scanner is designed to be used in explosion-hazardous areas. For proper operation in explosion-hazardous areas, the permissible USB cordsets CBL-IDMx60-D-J1-U* / RS232 cordsets CBL-IDMx60-D-J1-S* must be used. The intrinsically safe power supply and data transfer is realized via this cable. The connection in this structure uses the supply module SK-IDM-Z1-160-BD-1D-J1-*, which is connected to the communication interface (USB/RS232) of the host PC in the safe area. Data communication is via the USB/RS232 interface, while the handheld scanner is powered by the supply module and the external power supply is intrinsically safe.



Note

With the USB-interface version, the maximum total cable length between the host - e.g., VisuNet GXP or host PC in the safe area - and the handheld scanner is limited to 5 m! This includes the scanner cable CBL-IDMx60-D-J1-U*.

3.5 IDM-Z1-260-D-2D-J1-S1-N-N0 System Structure 1

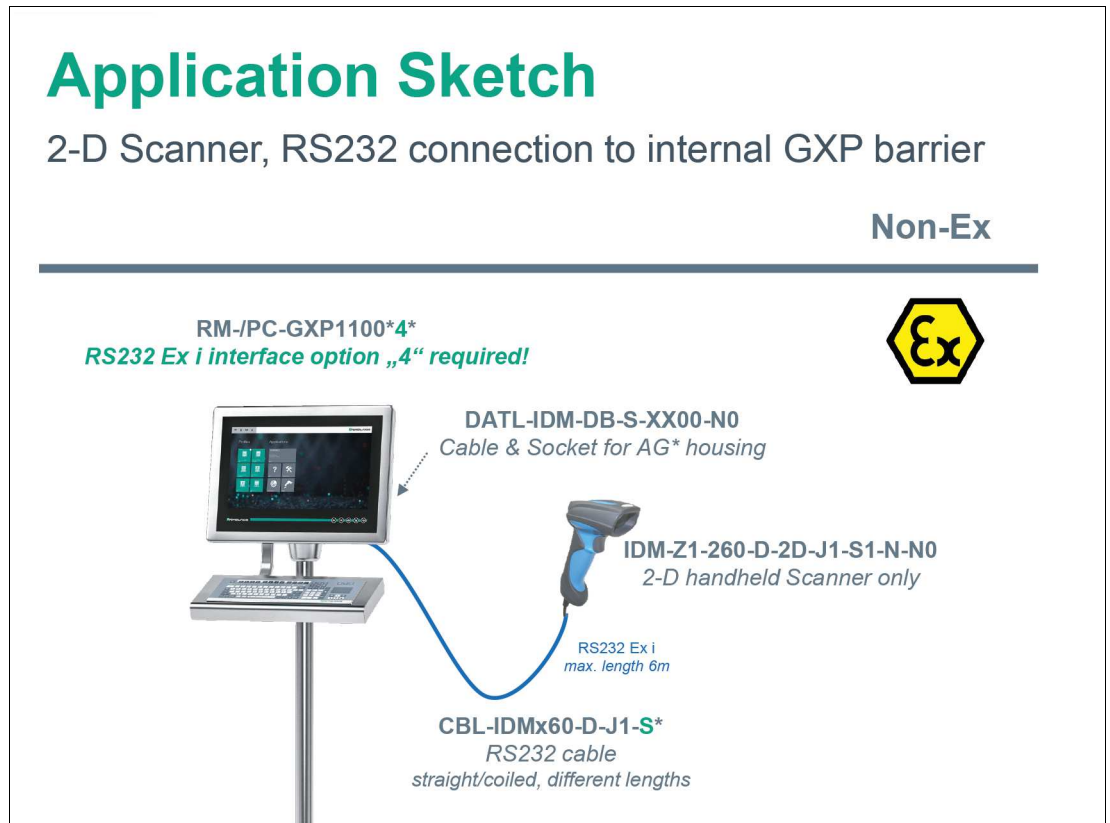

Figure 3.5 System structure 1 – 2-D handheld scanner connected to RS232 Ex i VisuNet GXP

Description

The handheld scanner is designed to be used in explosion-hazardous areas. For proper operation in explosion-hazardous areas, the permissible RS232 cordsets CBL-IDMx60-D-J1-S* must be used. The intrinsically safe power supply and data transfer is realized via this cable. An accessory cable DATL-IDM-DB-S-XX00-N0 is required for a connection to the VisuNet GXP in the AG-XX00 housing. This provides the housing feedthrough and has a connection socket that fits the scanner connection cable.



Note

The installation of the IDM-Z1-260- D-2D-J1-S1-N-N0 Barcode Reader to the integrated barrier of the VisuNet GXP or VisuNet IXD requires the optional interface "4". Please refer to the VisuNet GXP and VisuNet IXD Datasheets (Module A and B) for further information regarding the interfaces.

3.6 IDM-Z1-260-D-2D-J1-S1-N-N0 System Structure 2

Overview of the complete system structure 2: Wired 2-D handheld scanner IDM-Z1-260-D 2D-J1-S1-N-N0 connected to the supply module and the RS232 Ex e interface of the VisuNet GXP.

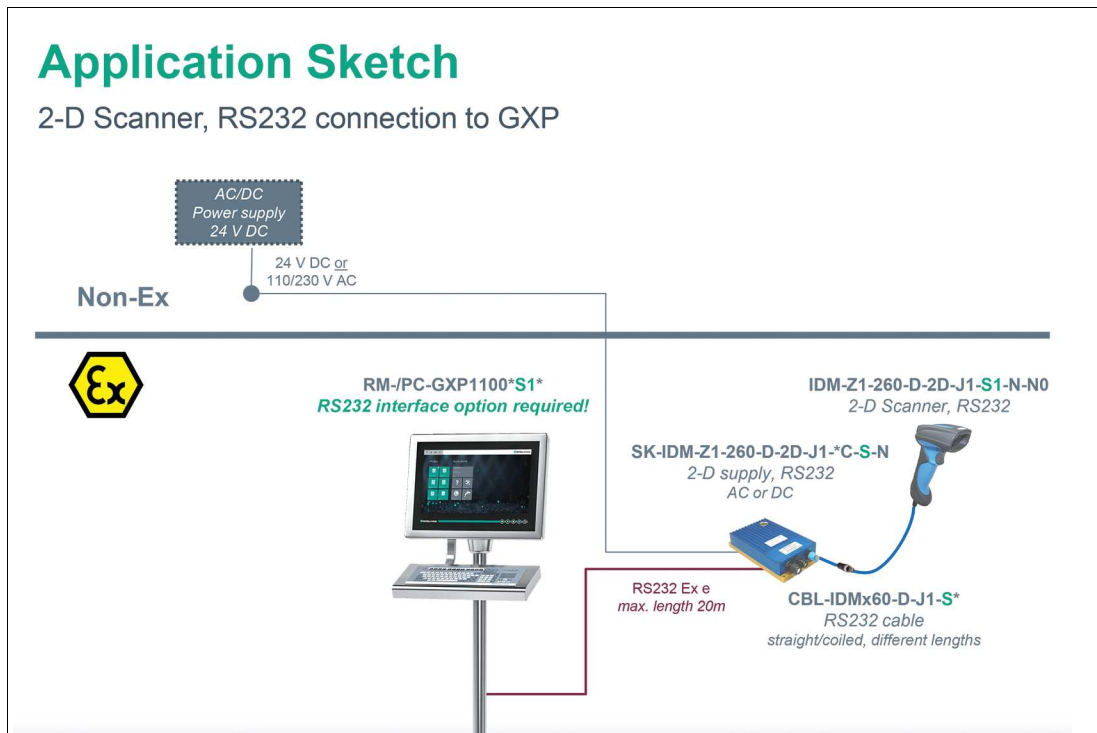

Figure 3.6 System structure 2

Description:

The handheld scanner is designed to be used in explosion-hazardous areas. For proper operation in explosion-hazardous areas, one of the permissible RS232 cordsets CBL-IDMx60-D-J1-S* must be used. The intrinsically safe power supply and data transfer is realized via this cable. The connection in this structure uses the supply module SK-IDM-Z1-260-D-2D-J1-*C-S-N, which is connected to the RS232 Ex e interface of the VisuNet GXP or another VisuNet operator workstation. Data communication is via the RS232 Ex e interface, while the handheld scanner is powered by the supply module and the external power supply is intrinsically safe.

The handheld scanner and the supply module may be connected and used in explosion-hazardous areas. The current rating of the connection line must be observed.

Note

This setup is also available for USB. With the USB-interface version, the maximum total cable length between the host - e.g., VisuNet GXP or host PC in the safe area - and the handheld scanner is limited to 5 m! This includes the scanner cable CBL-IDMx60-D-J1-U*. The setup is identical to the RS232 setup. Make sure to use the compatible USB cables though.

3.7 IDM-Z1-260-D-2D-J1-S1-N-N0 System Structure 3

Overview of the complete system structure 3: Wired 2-D handheld scanner IDM-Z1-260-D-2D-J1-S1-N-N0 connected to the supply module and a host PC in the safe area.

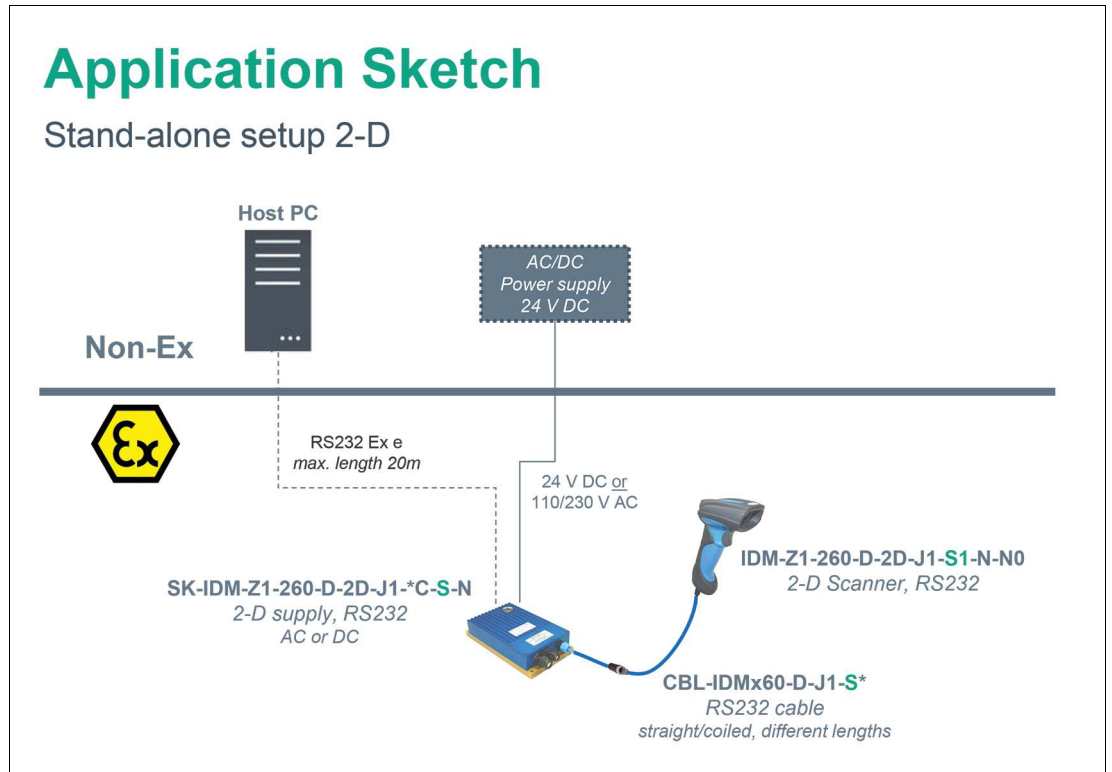

Figure 3.7 System Structure 3

Description:

The 2-D Code Handheld Reader is designed to be used in explosion-hazardous areas. For proper operation in explosion-hazardous areas, the permissible RS232 cordsets CBL-IDMx60-D-J1-S* must be used. The intrinsically safe power supply and data transfer is realized via this cable. The connection in this structure uses the supply module SK-IDM-Z1-260-D-2D-J1-*C-S-N0, which is connected to the RS232 communication interface of the host PC in the safe area. Data communication is via the RS232 interface, while the 2-D Code Handheld Reader is powered by the supply module and the external power supply is intrinsically safe.

The handheld scanner and the supply module may be connected and used in explosion-hazardous areas. The current rating of the connection line must be observed.

4 Commissioning

4.1 Connection of the Wired Handheld Scanners



Connection of wired handheld scanners

Connect the RJ50 plug on the connection cable CBL-IDMx60* for connecting the handheld scanner to the power module at the bottom of the scanner. Make sure that they are properly connected.

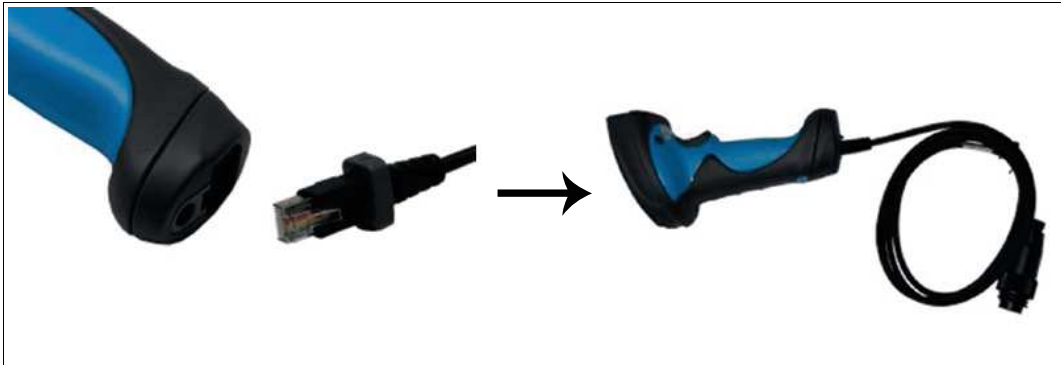

Figure 4.1

Connect the male M12 connector of the connection cable CBL-IDMx60*. After plugging together, make sure that the connection is fully secured with the screw cap.

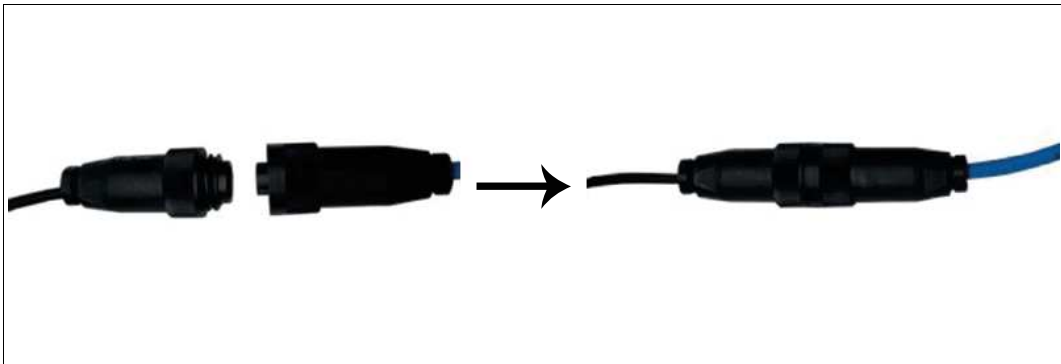

Figure 4.2

4.2 Supply Module Connection

The terminal assignment is located under the unscrewable opening on the front of the power module.



Danger!

Do not open the housing in the explosion-hazardous area!

Before the device is put into operation in explosion-hazardous areas, it must be ensured that the housing is completely closed again and screwed on properly.

Only trained and qualified personnel may connect the cables.

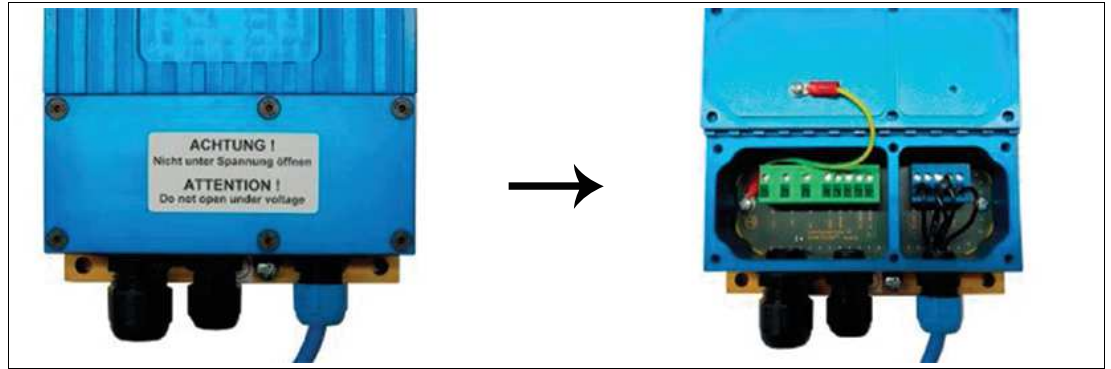

Figure 4.3 Supply module terminal compartment

Connection of the Handheld Scanner to the Supply Module RS232 or USB via Connector - Plug/Coupling

The terminal assignment is located under the unscrewable opening on the front of the supply module.

- (1) Ex e terminal compartment to connect the power supply and the data line
- (2) Ex i terminal compartment to connect the consumers (scanner)

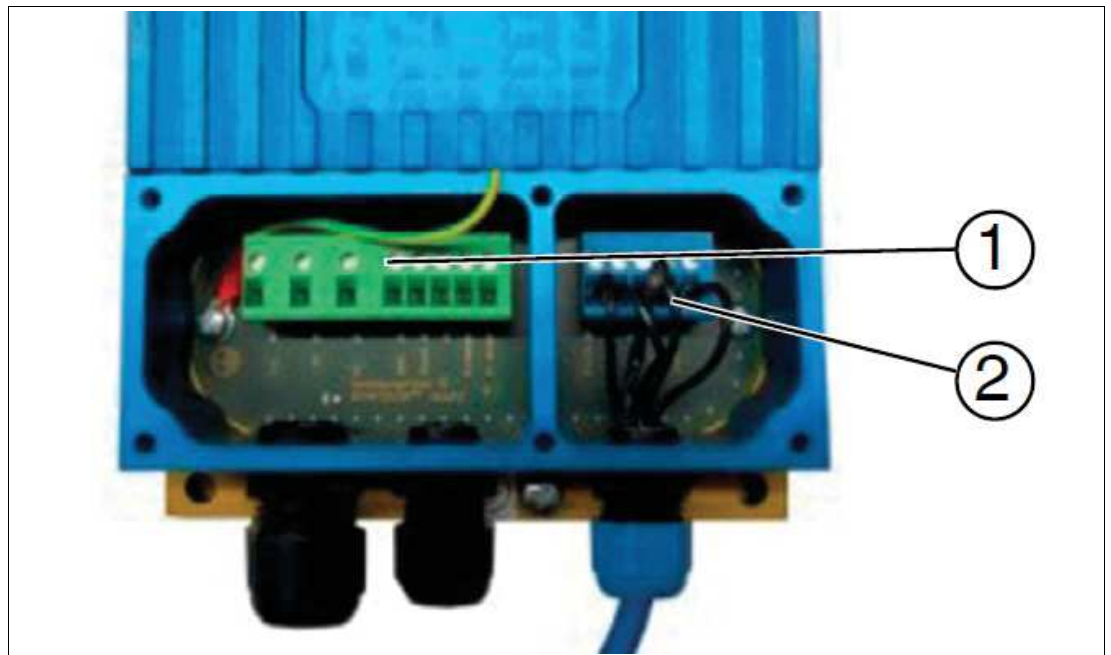

Figure 4.4 Supply module terminal compartment

External power module connection lines:

Data cables	USB: 0.2 mm ² – 2.5 mm ² , 4-core
	RS232: 0.2 mm ² – 2.5 mm ² , 3-core
Supply line	0.2 mm ² – 2.5 mm ² , 3-core
(see accessories in the appendix)	

The blue base connection cable is delivered pre-assembled with the supply module SK-IDM-Z1-*. The cable consists of a M12 connector plug and a 3-core cable. The individual cores are numbered (printed on the core insulation) and must be connected as follows to the intrinsically safe terminals of the supply module.

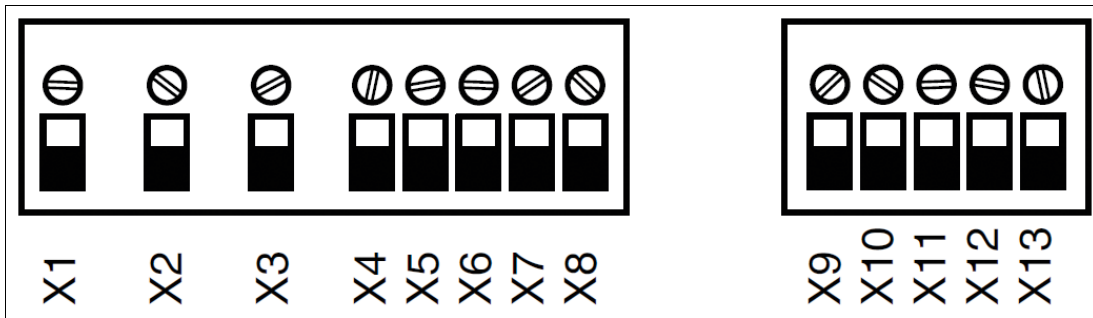

Figure 4.5

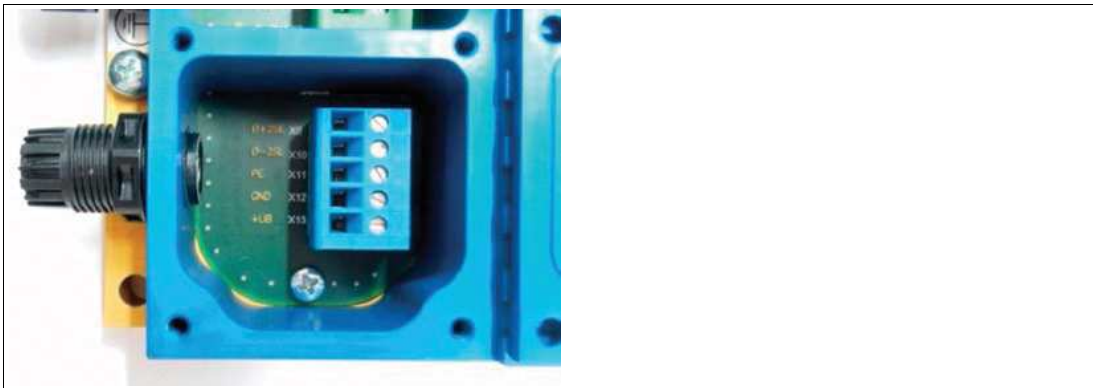

Figure 4.6 Intrinsically safe terminal compartment of the supply module after removing the connector connection cores

4.3 Base connection line RS232

Assignment of pre-installed base connection cable to supply module (RS232)

Assignment of pre-assembled connection coupling		Supply module terminal compartment	
Pin	Core designation	Designation	Number
3	3	RxD	X9
		GND	X10
		PE	X11
2	2	GND	X12
1	1	+UB	X13

Direct Connection of the Handheld Scanner without a Plug/Coupling to the Supply Module with RS232 Interface

The handheld scanner can be connected directly to the supply module without using the blue connection cable.

The assignment of the serial handheld scanner cable is outlined in the following table

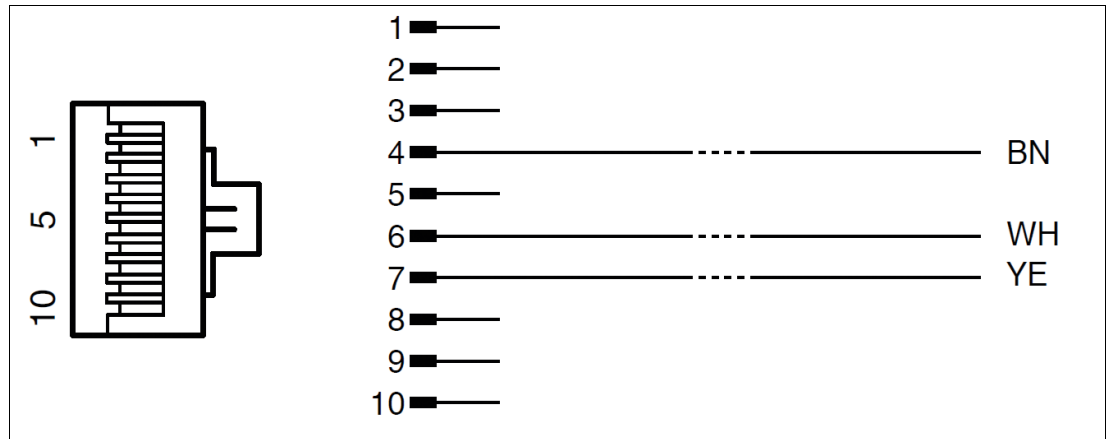

Figure 4.7

Assignment of connection cable CBL-IDM-x61* to supply module (RS232)

Cordset assignment		Supply module terminal compartment	
RJ50 pinout	Strand color	Designation	Assignment
6	White	TxD	X9
			X10
			X11
4	Brown	GND	X12
7	Yellow	+UB	X13



Note

Information relating to programming from the SICK AG manual (www.SICK.com) is required for the complete commissioning of the handheld scanner.

4.4

Base connection line USB

Pinout of connector plug	
Pin	Designation
3	D+
2	D-
4	GND
1	+UB

Connection of USB connection cable to supply module

Pre-assembled connection coupling		Terminal compartment	
Pin	Core	Designation	Number
3	3	D+	X9
2	4	D-	X10
		PE	X11
4	2	GND	X12
1	1	+UB	X13

Direct Connection of the Handheld Scanner without a Plug/Coupling to the Supply Module with USB Interface

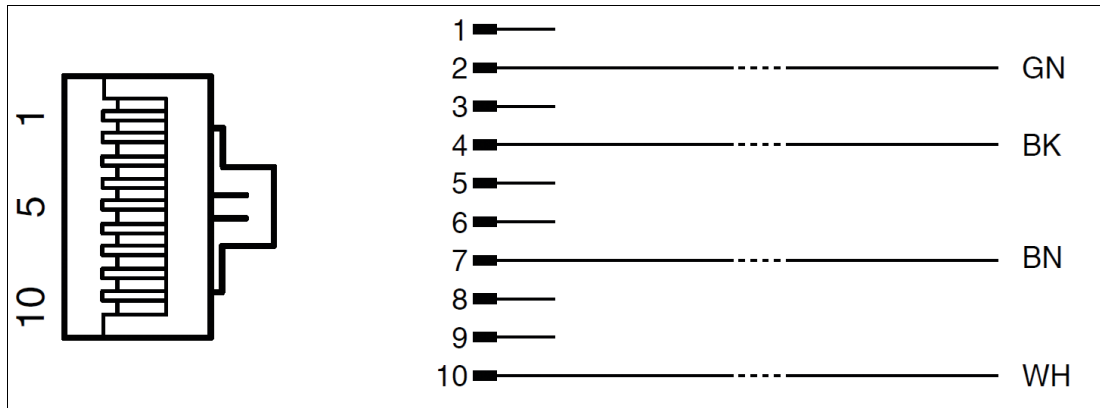

Figure 4.8

Handheld scanner cordset

Cordset assignment		Supply module terminal compartment	
RJ50 pinout	Strand color	Designation	Assignment
2	Green	D+2SL	X9
10	White	D-2SL	X10
			X11
7	Black	GND	X12
4	Brown	+UB	X13



Note

Information relating to programming from the SICK AG manual (www.SICK.com) is required for the complete commissioning of the handheld scanner.





5 Accessories

Corded Handheld Reader Mounting Accessories

Item number	Product name	Description	Photo
#548267	SCANNER-HOLDER-U1-XX00-N0	Scanner holder compatible with Housing AG-XX00 Material: Stainless steel AISI 316L (1.4404) Compatible with IDMx6x, ecom IdentEx 01 and PSCAN Prepared for mounting to right side of housing	
#548268	SCANNER-HOLDER-U1-AG1-N0	Scanner holder compatible with Housing AG1 Material: Stainless steel AISI 316L (1.4404) Compatible with IDMx6x, ecom IdentEx01 and PSCAN Prepared for mounting to right side of housing	
#548353	SCANNER-HOLDER-IDMx6x-TRIPOD	Tripod Scanner holder Compatible to IDMx6x code scanner	
#548354	SCANNER-HOLDER-IDMx6x-DESKTOP	Desktop Scanner holder Compatible to IDMx6x code scanner	

Corded Handheld Reader Accessories for VisuNet HMI Applications

Suitable for Zone 1/21 & Zone 2/22					
Item number	Product name	Description	Cable		Photo
#548333	CBL-IDMx60-D-J1-S-S18-N0	Connection cable for corded code readers Interface: RJ50 (Reader) with additional sealing ring to M12 male connector Protocol: Serial Compatible with IDM-Zx-x60-D* readers	Straight	1.8 m length	
#548334	CBL-IDMx60-D-J1-S-C38-N0		Coiled	3.8 m length	
#548335	CBL-IDM160-D-J1-U-S18-N0	Connection cable for corded code readers Interface: RJ50 (Reader) with additional sealing ring to M12 male connector Protocol: USB Compatible with IDM-Zx-x60-D* readers	Straight	1.8 m length	
#548336	CBL-IDM160-D-J1-U-C38-N0		Coiled	3.8 m length	
#548376	DATL-IDM-DB-S-XX00-N0	Connector cable for wired 1D Scanner IDM-Z1-160-D-1D-J1-S-* (S3-Interface required) and 2D Scanner IDM-Z2-260-D-2D-J1-S* (S4-interface required) compatible with Housing AG-XX00-* and AG1 - 4-wire with ferrules - IDM Scanner connection via M12-connector - Note: Supports only RS232 Scanner/Basestation	1.0 m length		

Supply module

Ex-protection: ATEX&IECEx Zone 1/21			
Item number	Product name	Description	Photo
#70115393	SK-IDM-Z1-160-BD-1D-J1-DC-S-N	Barrier for corded 1D reader & base station Input: 24 V DC Protocol: RS-232/422/485 Ex e (to host device) Compatible with IDM-Z1-160-D-1D-J1* and IDM-Z1-x61-B-J1* with serial connection cables incl. short setup cable with M12 female socket	
#70115394	SK-IDM-Z1-160-BD-1D-J1-DC-U-N	Barrier for corded 1D reader & base station Input: 24 V DC Protocol: USB Ex e (to host device) Compatible with IDM-Z1-160-D-1D-J1* and IDM-Z1-x61-B-J1* with USB connection cables incl. short setup cable with M12 female socket	
#70115395	SK-IDM-Z1-160-BD-1D-J1-AC-S-N	Barrier for corded 1D reader & base station Input: 24 V DC Protocol: RS-232/422/485 Ex e (to host device) Compatible with IDM-Z1-160-D-1D-J1* and IDM-Z1-x61-B-J1* with serial connection cables incl. short setup cable with M12 female socket	
#70115396	SK-IDM-Z1-160-BD-1D-J1-AC-U-N	Barrier for corded 1D reader & base station Input: 230 V AC Protocol: USB Ex e (to host device) Compatible with IDM-Z1-160-D-1D-J1* and IDM-Z1-x61-B-J1* with USB connection cables incl. short setup cable with M12 female socket	

Ex-protection: ATEX&IECEX Zone 1/21			
Item number	Product name	Description	Photo
#70115397	SK-IDM-Z1-260-D-2D-J1-DC-S-N	Barrier for corded 2D reader Input: 24 V DC Protocol: RS-232/422/485 Ex e (to host device) Compatible with IDM-Z1-260-D-2D-J1* and serial connection cables incl. short setup cable with M12 female socket	
#70115398	SK-IDM-Z1-260-D-2D-J1-DC-U-N	Barrier for corded 2D reader Input: 24 V DC Protocol: USB Ex e (to host device) Compatible with IDM-Z1-260-D-2D-J1* and USB connection cables incl. short setup cable with M12 female socket	
#70115399	SK-IDM-Z1-260-D-2D-J1-AC-S-N	Barrier for corded 2D reader Input: 230 V AC Protocol: RS-232/422/485 Ex e (to host device) Compatible with IDM-Z1-260-D-2D-J1* and serial connection cables incl. short setup cable with M12 female socket	
#70115400	SK-IDM-Z1-260-D-2D-J1-AC-U-N	Barrier for corded 2D reader Input: 230 V AC Protocol: USB Ex e (to host device) Compatible with IDM-Z1-260-D-2D-J1* and USB connection cables incl. short setup cable with M12 female socket	

Cable accessories

Item Number	Product Name	Description	Cable
#548379	S-RN2/DB9-5-N0	RS232 cable with SUB-D9 plug (female) and open cable ends with wire end ferrules	5 m length
#548380	S-RN2/DB9-20-N0	RS232 cable with SUB-D9 plug (female) and open cable ends with wire end ferrules	20 m length
#193077	DATL-A3-1.5-1	Supply line for 90 – 240 VAC supply 3 x 1.5 mm ² , diameter 8.1 mm Assembly 6 x 1.5 mm ² wire end ferrules	
#913886	S-UN2/USB	USB cable with USB Type A plug (male) and open cable ends with wire end ferrules	1 m length

Your automation, our passion.

Explosion Protection

- Intrinsic Safety Barriers
- Signal Conditioners
- FieldConnex® Fieldbus
- Remote I/O Systems
- Electrical Ex Equipment
- Purge and Pressurization
- Industrial HMI
- Mobile Computing and Communications
- HART Interface Solutions
- Surge Protection
- Wireless Solutions
- Level Measurement

Industrial Sensors

- Proximity Sensors
- Photoelectric Sensors
- Industrial Vision
- Ultrasonic Sensors
- Rotary Encoders
- Positioning Systems
- Inclination and Acceleration Sensors
- Fieldbus Modules
- AS-Interface
- Identification Systems
- Displays and Signal Processing
- Connectivity

Pepperl+Fuchs Quality

Download our latest policy here:

www.pepperl-fuchs.com/quality

