

PGV100R-F200-B16\*

# Incident Light Positioning System

Manual



CANopen



Your automation, our passion.

 **PEPPERL+FUCHS**

---

With regard to the supply of products, the current issue of the following document is applicable:  
The General Terms of Delivery for Products and Services of the Electrical Industry, published  
by the Central Association of the Electrical Industry (Zentralverband Elektrotechnik und Elek-  
troindustrie (ZVEI) e.V.) in its most recent version as well as the supplementary clause:  
"Expanded reservation of proprietorship"

**Worldwide**

Pepperl+Fuchs Group  
Lilienthalstr. 200  
68307 Mannheim  
Germany  
Phone: +49 621 776 - 0  
E-mail: [info@de.pepperl-fuchs.com](mailto:info@de.pepperl-fuchs.com)

**North American Headquarters**

Pepperl+Fuchs Inc.  
1600 Enterprise Parkway  
Twinsburg, Ohio 44087  
USA  
Phone: +1 330 425-3555  
E-mail: [sales@us.pepperl-fuchs.com](mailto:sales@us.pepperl-fuchs.com)

**Asia Headquarters**

Pepperl+Fuchs Pte. Ltd.  
P+F Building  
18 Ayer Rajah Crescent  
Singapore 139942  
Phone: +65 6779-9091  
E-mail: [sales@sg.pepperl-fuchs.com](mailto:sales@sg.pepperl-fuchs.com)  
<https://www.pepperl-fuchs.com>

<b>1</b>	<b>Introduction.....</b>	<b>4</b>
1.1	Content of this Document.....	4
1.2	Target Group, Personnel .....	4
1.3	Symbols Used .....	5
<b>2</b>	<b>Product Description .....</b>	<b>6</b>
2.1	Use and Application .....	6
2.2	CANopen Interface .....	7
2.3	LED Indicators .....	8
2.4	Accessories.....	9
<b>3</b>	<b>Installation.....</b>	<b>10</b>
3.1	Mounting the Read Head.....	10
3.2	Affixing the Code Tape .....	11
3.3	Electrical Connection .....	20
<b>4</b>	<b>Commissioning.....</b>	<b>22</b>
4.1	Direction Decision .....	22
4.2	Parameterization Using Code Cards.....	23
4.2.1	The code cards "CANCEL", "USE", and "DEFAULT" .....	24
<b>5</b>	<b>Operation and communication.....</b>	<b>25</b>
5.1	Data Exchange in the CANopen Bus .....	25
5.1.1	General Information about CANopen.....	25
5.1.2	Basic Technical Information about CANopen .....	26
5.1.3	CANopen Object Directory .....	29
5.1.3.1	Orientation O .....	45
5.1.3.2	Side S .....	45
5.1.3.3	Position/Lane .....	46
5.1.4	LSS Service.....	46
5.1.5	Object 3001 .....	46
5.2	Operation Using Control Codes .....	48
5.3	Operation in case of repair .....	49
<b>6</b>	<b>Appendix .....</b>	<b>50</b>
6.1	ASCII table.....	50
6.2	Code Cards with Special Functions.....	51
6.3	Code Cards for Setting the Baud Rate .....	54
6.4	Code Cards for Termination Resistor.....	57
6.5	Code cards to configure the fieldbus address .....	58

# 1 Introduction

## 1.1 Content of this Document

This document contains information required to use the product in the relevant phases of the product life cycle. This may include information on the following:

- Product identification
- Delivery, transport, and storage
- Mounting and installation
- Commissioning and operation
- Maintenance and repair
- Troubleshooting
- Dismounting
- Disposal



---

**Note**

For full information on the product, refer to the further documentation on the Internet at [www.pepperl-fuchs.com](http://www.pepperl-fuchs.com).

---



---

**Note**

For specific device information such as the year of construction, scan the QR code on the device. As an alternative, enter the serial number in the serial number search at [www.pepperl-fuchs.com](http://www.pepperl-fuchs.com).

---

The documentation comprises the following parts:

- This document
- Datasheet

In addition, the documentation may comprise the following parts, if applicable:

- EU-type examination certificate
- EU declaration of conformity
- Attestation of conformity
- Certificates
- Control drawings
- Instruction manual
- Functional safety manual
- Other documents

## 1.2 Target Group, Personnel

Responsibility for planning, assembly, commissioning, operation, maintenance, and dismantling lies with the plant operator.

Only appropriately trained and qualified personnel may carry out mounting, installation, commissioning, operation, maintenance, and dismantling of the product. The personnel must have read and understood the instruction manual and the further documentation.

Prior to using the product make yourself familiar with it. Read the document carefully.

## 1.3 Symbols Used

This document contains symbols for the identification of warning messages and of informative messages.

### Warning Messages

You will find warning messages, whenever dangers may arise from your actions. It is mandatory that you observe these warning messages for your personal safety and in order to avoid property damage.

Depending on the risk level, the warning messages are displayed in descending order as follows:



---

#### **Danger!**

This symbol indicates an imminent danger.

Non-observance will result in personal injury or death.

---



---

#### **Warning!**

This symbol indicates a possible fault or danger.

Non-observance may cause personal injury or serious property damage.

---



---

#### **Caution!**

This symbol indicates a possible fault.

Non-observance could interrupt the device and any connected systems and plants, or result in their complete failure.

---

### Informative Symbols



---

#### **Note**

This symbol brings important information to your attention.

---



---

#### **Action**

1. This symbol indicates a paragraph with instructions. You are prompted to perform an action or a sequence of actions.

## 2 Product Description

### 2.1 Use and Application

#### Intended Use

This device, when used together with Data Matrix code tape affixed to the floor and tags printed with Data Matrix codes, constitutes a high-resolution lane tracking and positioning system. It can be used in all applications where vehicles in Auto-Guided Transport Systems are to be positioned precisely at marked positions along a given track.

The read head forms part of the positioning system in the Pepperl+Fuchs incident light process. The read head's features include a camera module and an integrated illumination unit, which the read head uses to detect a strip of Data Matrix code tape stuck to the floor to track the lane. The read head detects Data Matrix tags to navigate within a grid. The read head detects control codes and position markers in the form of Data Matrix codes printed on a self-adhesive code tape.

The read head is located on an Auto-Guided Transport System and guides this along the Data Matrix code tape.

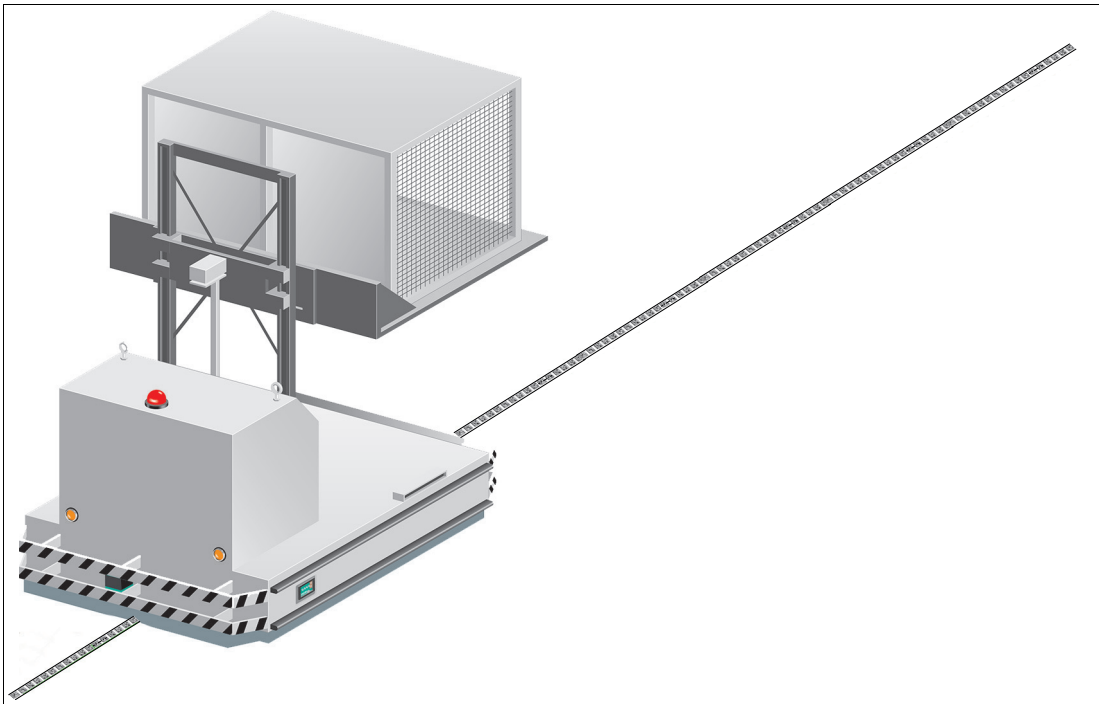

Figure 2.1 Auto-Guided Transport System with Data Matrix code tape

## Tag Mode

In addition to the lane tracking, you can use the read head in tag mode. The read head detects Data Matrix tags, which are typically glued onto the floor in a grid. The individual Data Matrix tags are numbered consecutively and include position information. The read head reports the position of the Auto-Guided Transport System in relation to the zero point of the Data Matrix tag to the control panel.

The tag mode allows the Auto-Guided Transport System to move freely in as large a grid as desired, without having to mark the crossing paths with lane tapes.

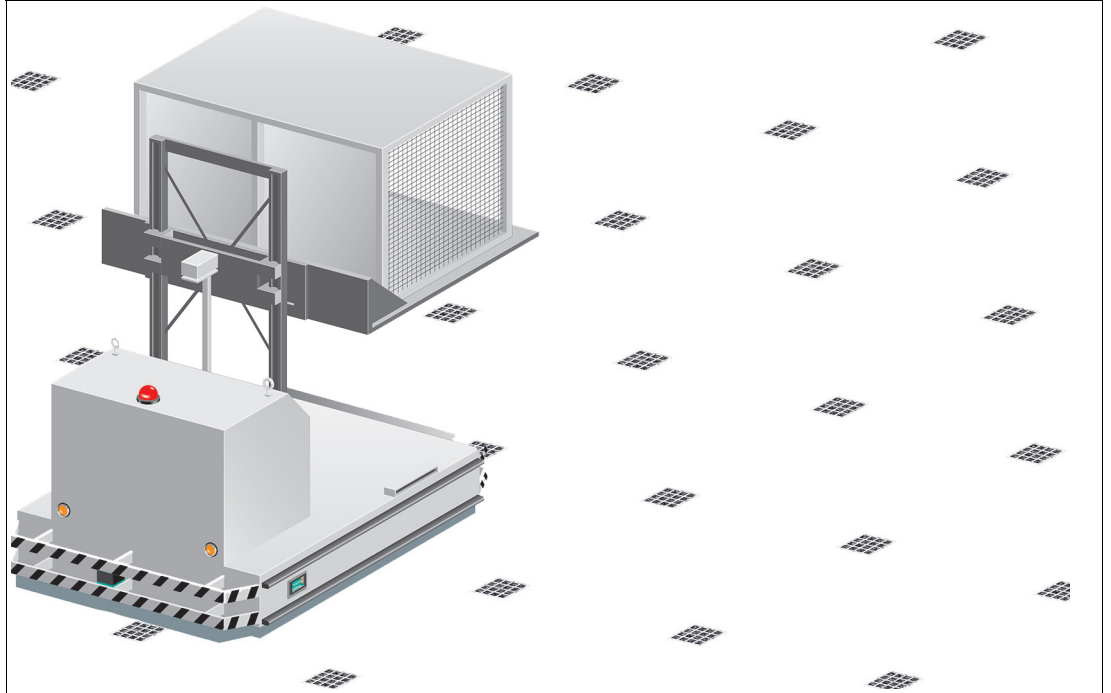

Figure 2.2 Auto-Guided Transport System with Data Matrix tags

The read head switches automatically between tag mode and lane tracking. This allows a transport system to be guided from one Data Matrix tag grid via a Data Matrix code tape lane to another Data Matrix tag grid.

The extensive yet user-friendly parameterization options as well as the configurable inputs and outputs mean that the read head can easily be adapted to suit each application.

## 2.2 CANopen Interface

The read head is equipped with a CANopen interface for communication purposes, i.e., parameterizing the read head functions or reading out current process data during operation. Data on the CANopen network can be exchanged at various baud rates between 125 kBaud and 1 MBaud. The read head supports the following baud rates:

- 125 kBaud
- 250 kBaud
- 500 kBaud
- 1 MBaud

## 2.3 LED Indicators

The read head is equipped with two indicator LEDs for carrying out visual function checks and quick diagnostics.

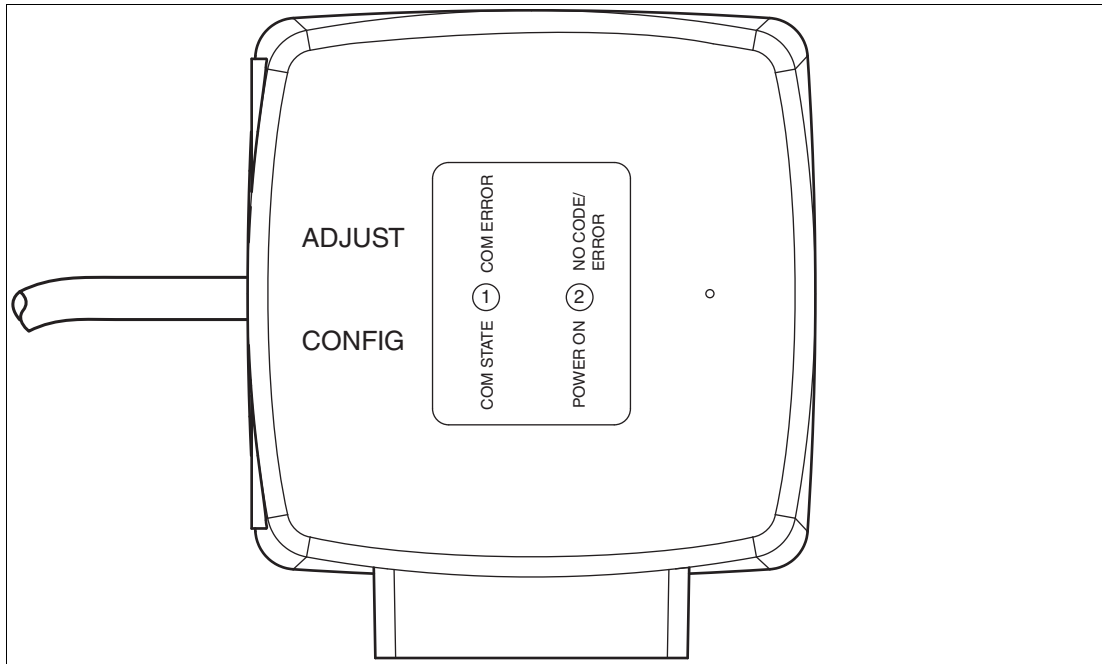

Figure 2.3 Display Elements

### LEDs

LED	Color	Label	Meaning
1	Green/yellow	COM STATE COM ERROR	Communication active Communication error
2	Green/red	POWER ON NO CODE/ERROR	Code detected/not detected, error

Table 2.1 LEDs

### LED fault indicator

LED	1		2		Description
	Green	Yellow	Green	Red	
State	Flickers	Off	x	x	Auto baud rate detection in progress
	Flashing	Off	x	x	General configuration error
	Lights up	Off	x	x	Bus off

Table 2.2 LED fault indicator

x: LED status has no meaning



**LED operating mode indicator**

LED	1		2		Description
	Green	Yellow	Green	Red	
State	Off	Flickers	x	x	Auto baud rate detection in progress
	Off	Flashing	x	x	"Preoperational" mode
	Off	Lights up once	x	x	Stopped
	Off	Lights up	x	x	"Operational" mode

Table 2.3 LED operating mode indicator

x: LED status has no meaning

LED Behavior		
Flickers	10 Hz	
Flashing:	2.5 Hz	
Lights up once:	LED on for 200 ms;	Off for 1 s

LED	1		2		Description
	Green	Yellow	Green	Red	
State	x	x	Lights up	Off	Code detected
	x	x	Off	Flashing	Code not detected
	x	x	x	Lights up	System error
	x	x	Lights up, 1 s	Off	Codecard read
	x	x	Off	Lights up, 1 s	Codecard not read

x: LED status has no meaning

Sensor switched on: at least one of the LEDs is on or flashing

**2.4 Accessories**

Compatible accessories offer enormous potential for cost savings. They save you a great deal of time and effort when commissioning for the first time, and when replacing and maintaining our products.

If products are used in harsh ambient conditions, appropriate Pepperl+Fuchs accessories can be used to extend the service life of these products.

Model number	Description
PGV-CC25-0*	Code tape, various control codes
PGV*M-CA25-0	Position tape, starting position 0, various lengths
PGV85-CT4	DataMatrix tag

Table 2.4 Accessories

## 3 Installation

### 3.1 Mounting the Read Head

Mount the read head on the auto-guided transport system using the four screws on the mounting adapter on the read head. Mount the read head so that the lens with ring light and camera module are aligned toward the floor.

The mounting must be stable enough so that the read head does not leave its depth of focus range during operation.

The distance between the read head and the floor should be the same as the read distance of the read head.

#### Optimum Read Distance

Model number	Read distance [mm]	Depth of focus [mm]	Field of vision (w x h) [mm]
PGV100R*	100	±30	115 x 73

#### Read Head Dimensions

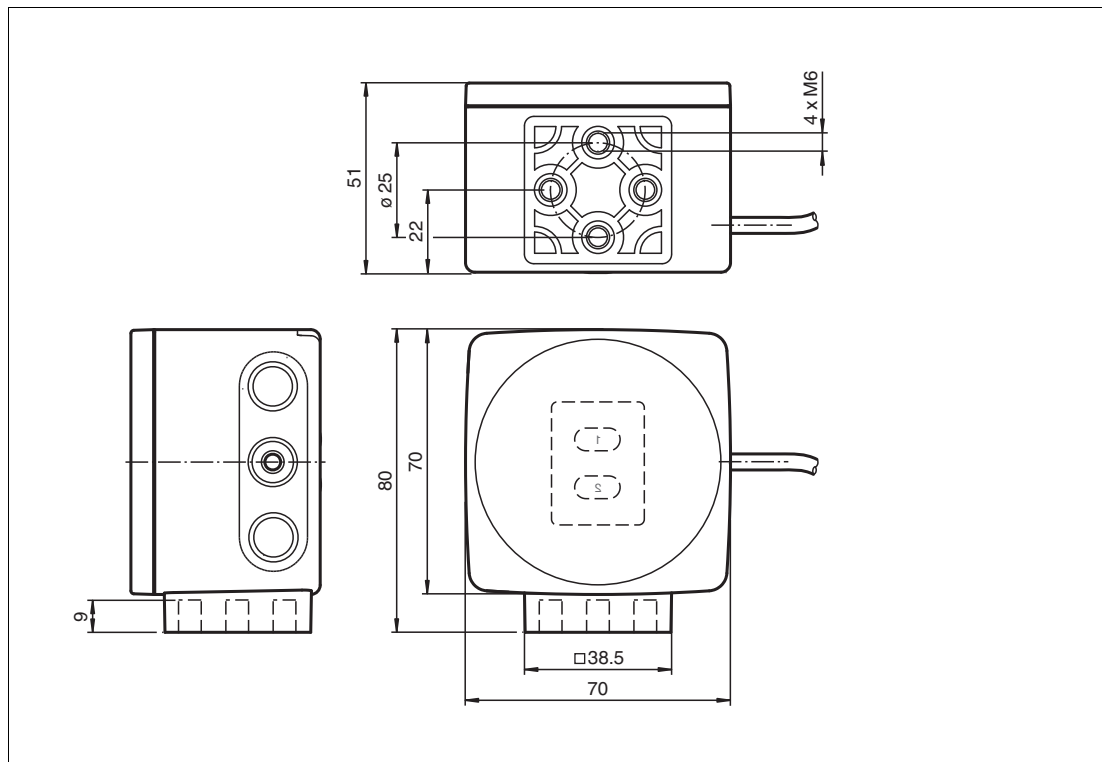

Figure 3.1 Housing dimensions



#### Caution!

When selecting the length of the mounting screws, ensure that the maximum insertion depth of the screws in the threaded inserts on the read head is 8 mm.

Using longer screws may damage the read head.



#### Caution!

The maximum torque of the mounting screws must not exceed 9 Nm.

Tightening the screws to a higher torque may damage the read head.

### 3.2 Affixing the Code Tape

#### Dimensions of the Code Tape

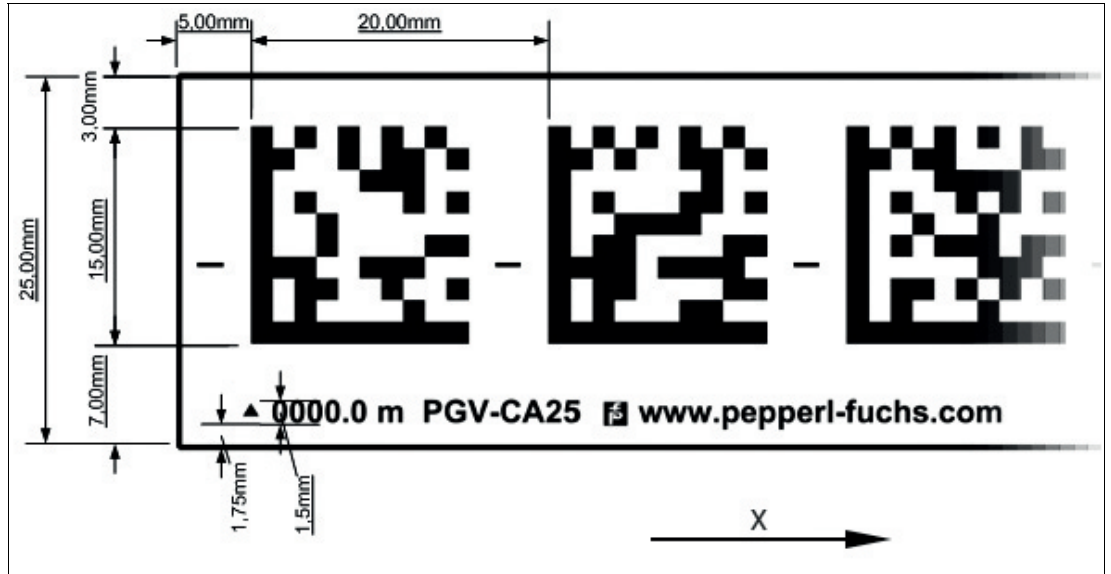

Figure 3.2 Dimensions of the Data Matrix code tape



#### Caution!

##### Alignment

The Data Matrix code is not on the center line of the code tape.



#### Caution!

##### Stop edges

If you attach another code tape at the end of a previous code tape, the code pattern of 20 mm must be retained.

The code tape is made of silicone-free polyester film. A position marker appears every 100 mm along the lower edge of the code tape (see "Code Tape Dimensions"). These position markers are used to affix the code tape in the correct position.

The back of the code tape is covered with a modified acrylate-based adhesive designed for permanent adhesion. Affix the self-adhesive code tape along the desired traverse distance. To do so, proceed as follows:

Position the code tape so that the **www.pepperl-fuchs.com** label and the position markings are to the right of the Data Matrix code in the X direction. The position values then increase along the X direction.

#### Data Matrix Code Tapes with a Starting Position of 0 m

Model number	Description
PGV10M-CA25-0	Code tape, length: 10 m
...	...
PGV100M-CA25-0	Code tape, length: 100 m

Table 3.1 Data Matrix code tapes

See also data sheet PGV\*-CA25-\* at [www.pepperl-fuchs.com](http://www.pepperl-fuchs.com)

**Data Matrix Control Codes**

Model number	Description
PGV-CC25-001	Code tape, Control Code 001, length: 1 m
...	...
PGV-CC25-999	Code tape, Control Code 999, length: 1 m

Table 3.2 Data Matrix control codes



**Affixing the Code Tape**

1. Clean the surface of any greasy or oily deposits and dust.
2. Ensure that the surface is dry, clean, and stable.
3. Pull away a few centimeters of the protective film at the beginning of the code tape. Place the code tape at the precise point of the required starting position on the surface, and press to attach.
4. Then affix the code tape along the desired traverse distance. Please note the following information:
5. Remove the protective film gradually so that the code tape does not accidentally adhere to the surface in an incorrect position. When affixing the code tape, ensure that it does not become creased or trap air bubbles.

↳ The adhesive on the code tape hardens after 72 hours.



**Note**

**Thermal Expansion of the Code Tape**

The affixed code tape corresponds to the heat expansion coefficient of the surface with regard to its thermal expansion. Keep this in mind when installing expansion joints, for example.



**Note**

**Expansion Joints and Code Tapes**

If the system covers longer distances, the plant structure usually contains expansion joints. In this case, we recommend creating breaks along the code tape. The resulting gap must not exceed 75 mm.



**Note**

**Inclines and Declines**

If you affix the code tape on inclines or declines, cut the code tape several times at the transition point to the horizontal as shown.

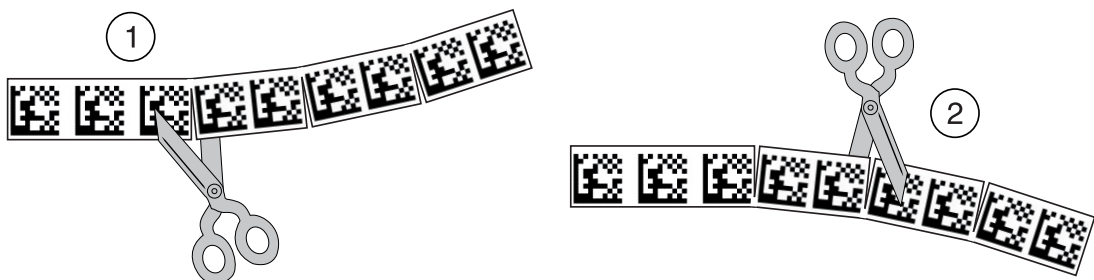

Figure 3.3 Schematic diagram: preparing Data Matrix code tape bends

1. Bend to the left
2. Bend to the right

## Cleaning the Code Tape

Significant contamination on code tapes can impair detection by the read head. Clean the code tapes with isopropanol if necessary. If the contamination is severe, you can use a non-corrosive plastic cleaner, e.g., Caramba®.



### Note

To avoid polishing the surface, do not apply strong pressure when cleaning. If the code tape has a shiny surface, this impairs detection by the read head.

## Angle Output



### Note

Angles are specified as absolute values. The respective value is calculated from the resolution selected under "Angle Resolution." With a resolution of  $0.1^\circ$ , an angle of  $60^\circ$  is output as  $60^\circ/0.1^\circ = 600$ .

The read head detects the absolute angle in relation to the tracked lane with a maximum resolution of  $0.1^\circ$ . The angle is specified as an absolute value relative to the tracked lane, as a Data Matrix code tape contains direction information. The output angle covers the range from  $0^\circ$  to  $360^\circ$ . The resolution can be set to the following values:

- $0.1^\circ$
- $0.2^\circ$
- $0.5^\circ$
- $1^\circ$

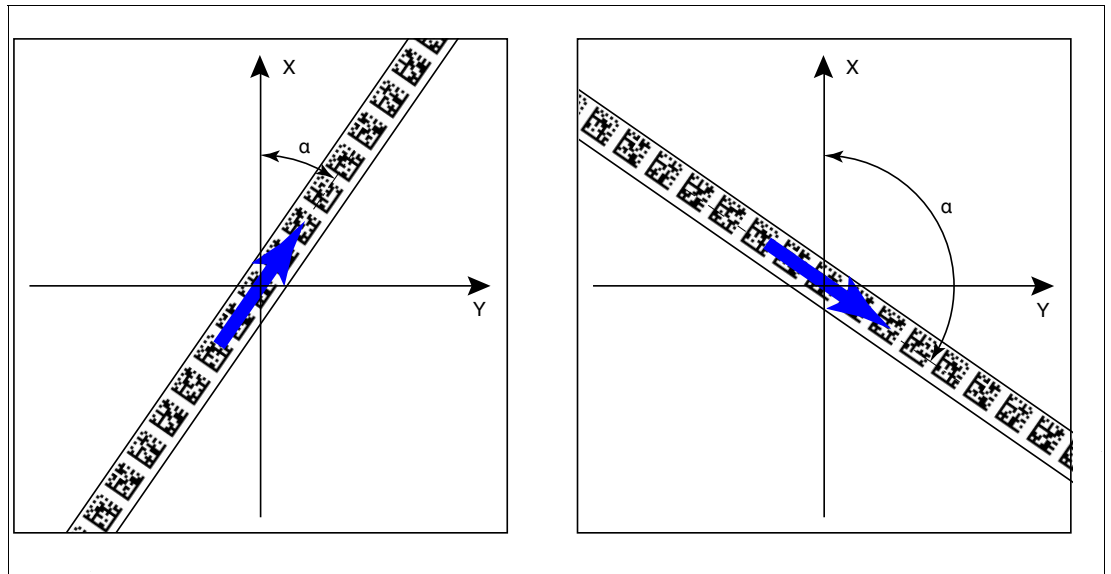

Figure 3.4 Absolute angle

## Distance Output

The read head detects the distance from the zero point in the Y direction a Data Matrix code tape and transmits this value to the control panel.

The reader indicates the vertical distance of the zero point in relation to the Data Matrix code tape.

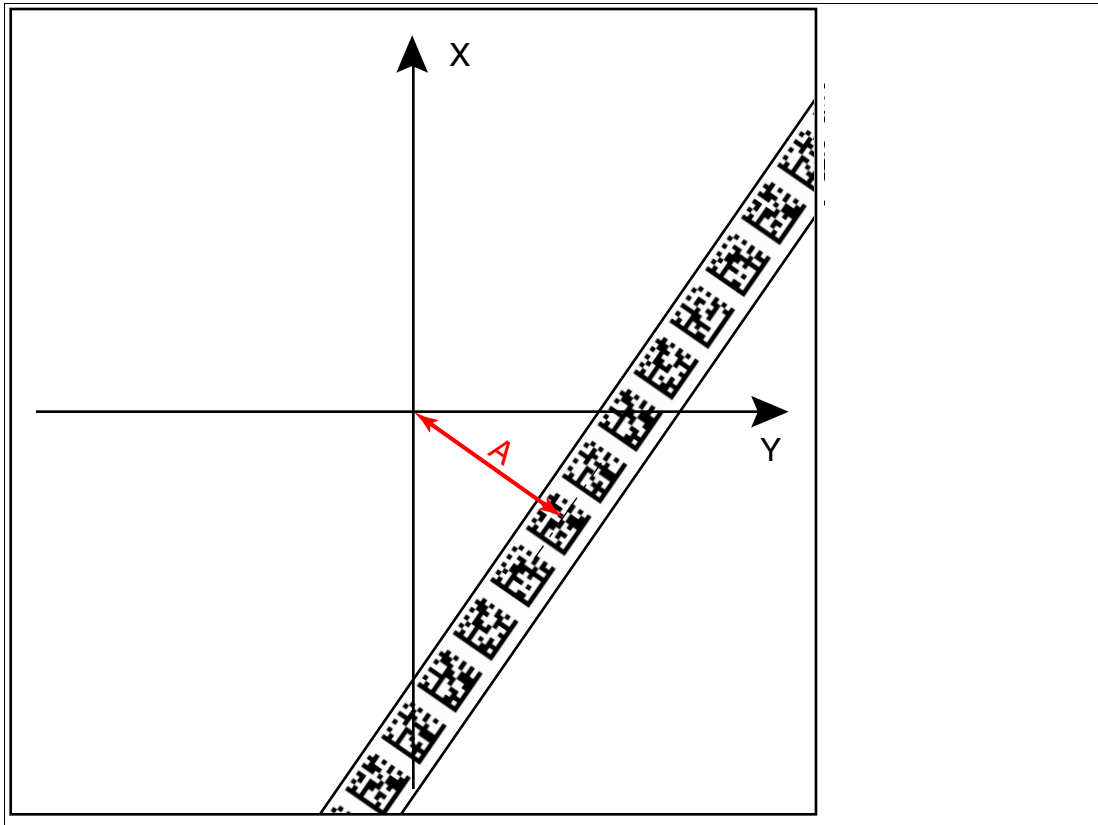

Figure 3.5 Distance A for Data Matrix code tape

### Note

#### Direction Decision

The direction decision at a branch of a Data Matrix code tape remains in effect until the read head has moved more than 50 cm away from the branch.

It is not possible to change the direction decision within a branch!

### Note

#### Branches/Intersections with Data Matrix Position Code

Observe the following guidelines with regard to the area 1 m before and after branches or intersections of a lane with a position code:

- The position codes of the main lane must run continuously for 2 m. The position codes of the branching/intersecting lane must run continuously for 1 m. The read head outputs the X-value of the Data Matrix code tape that is specified via the direction decision. .
- The difference between the absolute position of the main lane and the starting position of the branching/intersecting lane must be greater than 1 m.

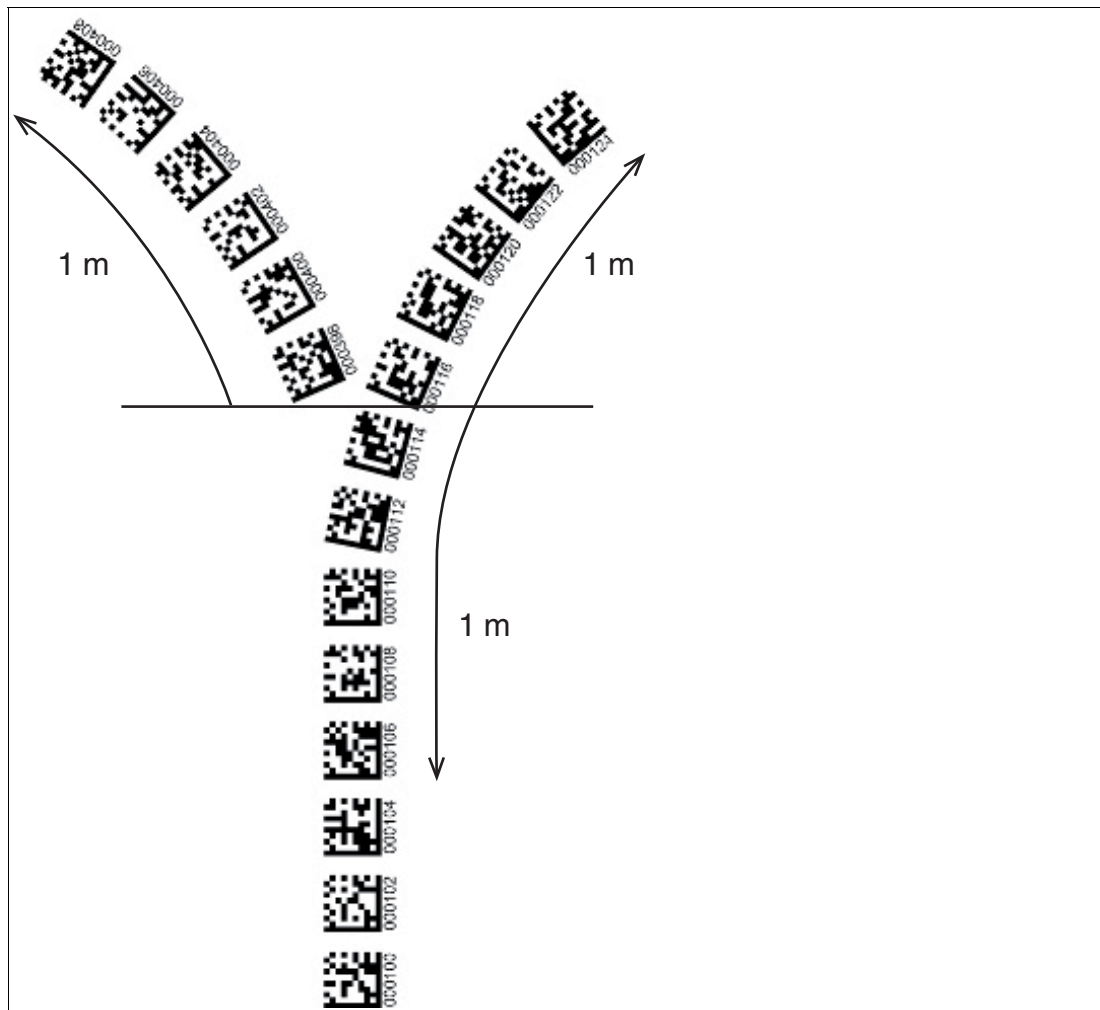

Figure 3.6 Distances

### Behavior of the Read Head at Branches and Curves

The read head behaves differently depending on the type of branch and the specified lane. The read head must know the upcoming direction decision.

A second lane branches off to the left from the straight lane:

The read head follows the straight lane if the direction decision "follow right-hand lane" has been made.

A second lane branches off to the right from the straight lane:

The read head follows the straight lane if the direction decision "follow left-hand lane" has been made.

A single lane with a position code turns to the left or right:

The read head follows the position code if the direction decision "straight ahead" has been made.



#### Note

##### Loss of Information

Ensure that Data Matrix codes are not positioned over one another at a branch, as otherwise data may be lost.

Control codes can be mounted in the immediate vicinity of a branch with Data Matrix codes for positioning, but not near an intersection. The control code must be mounted directly next to the guiding lane.

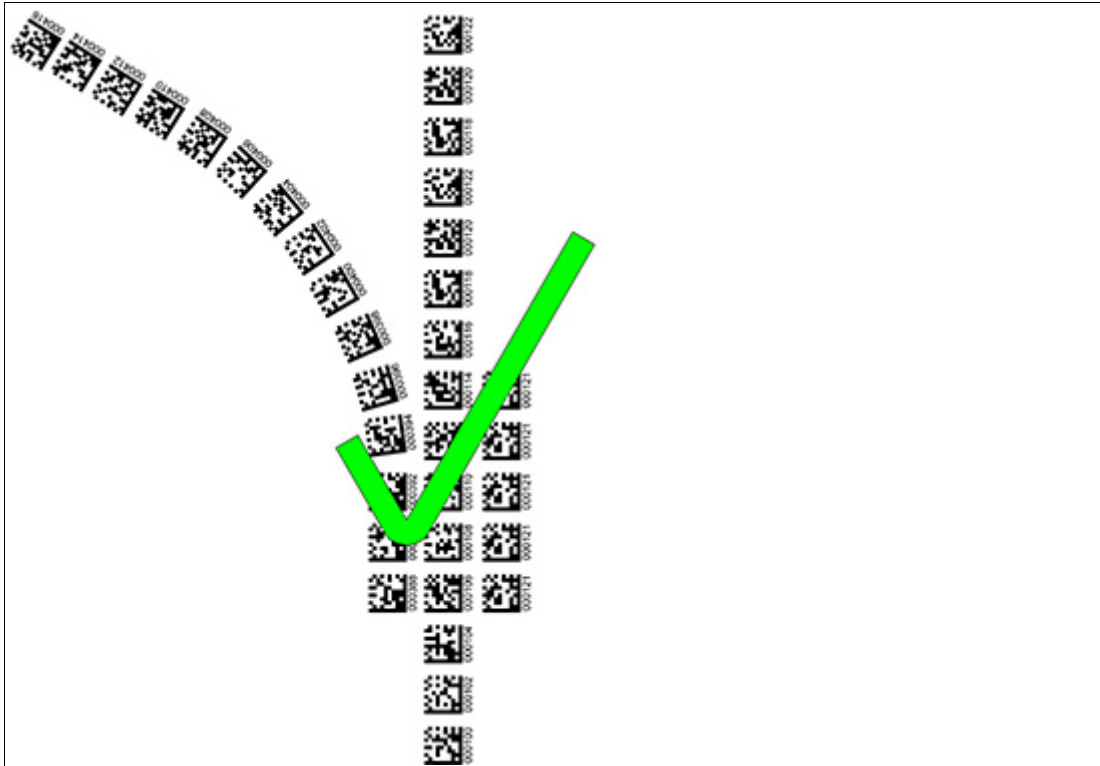

Figure 3.7 Branch with control code

### Distances

To ensure that the read head can clearly detect and assign Data Matrix codes, minimum and maximum distances must be observed when creating the lanes.

Offset  $V$  between position codes of a lane must not be greater than 5 mm.

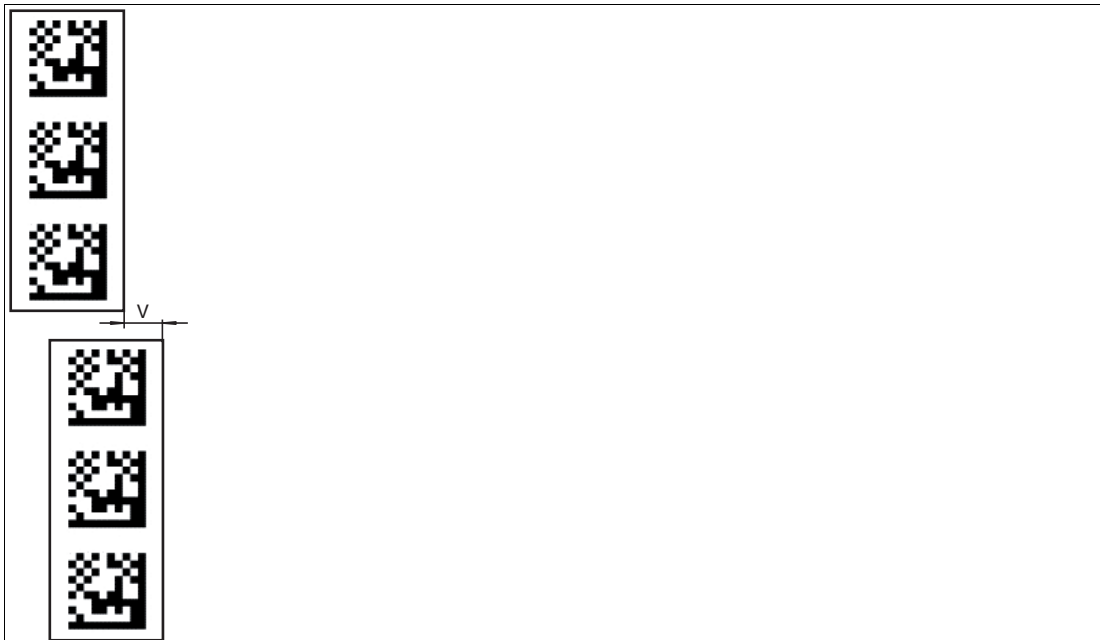

Figure 3.8 Offset:  $0 \text{ mm} \leq V \leq 5 \text{ mm}$

The distance between the Data Matrix code tapes at a branch or intersection as a separate lane must be between 0 mm and 5 mm.



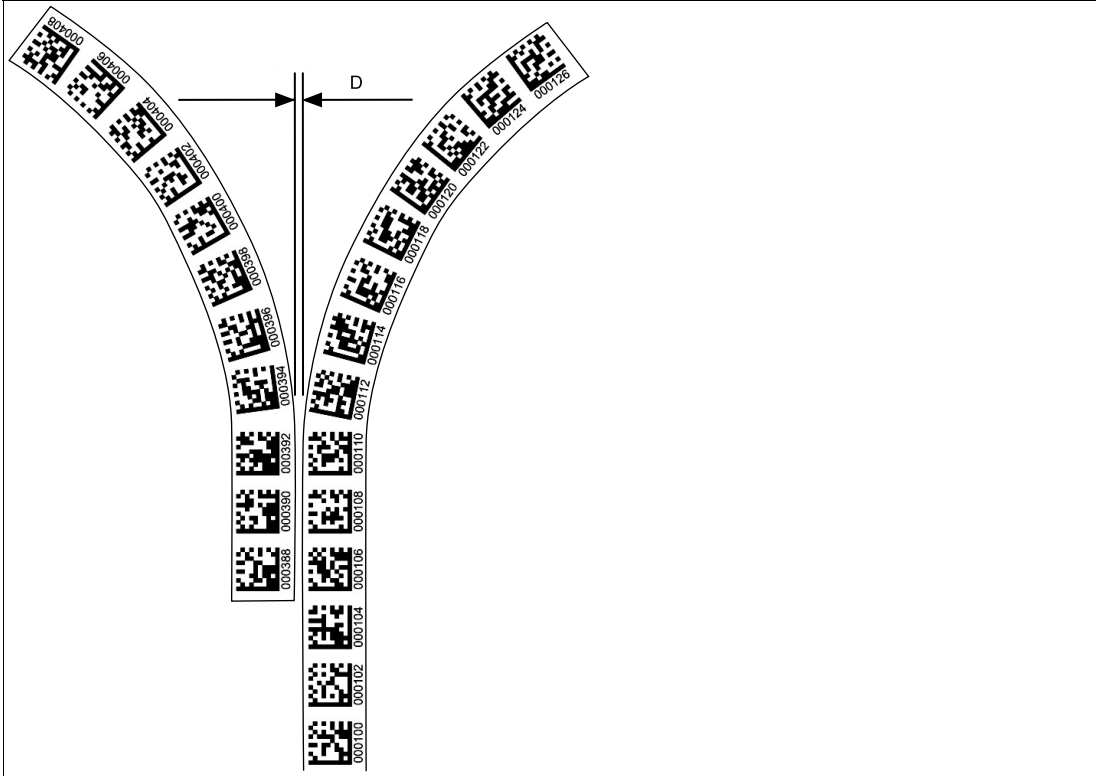

Figure 3.9 Distance:  $0 \text{ mm} \leq D \leq 5 \text{ mm}$

The distance between a Data Matrix position code and a Data Matrix control code must be between 0 mm and 5 mm.

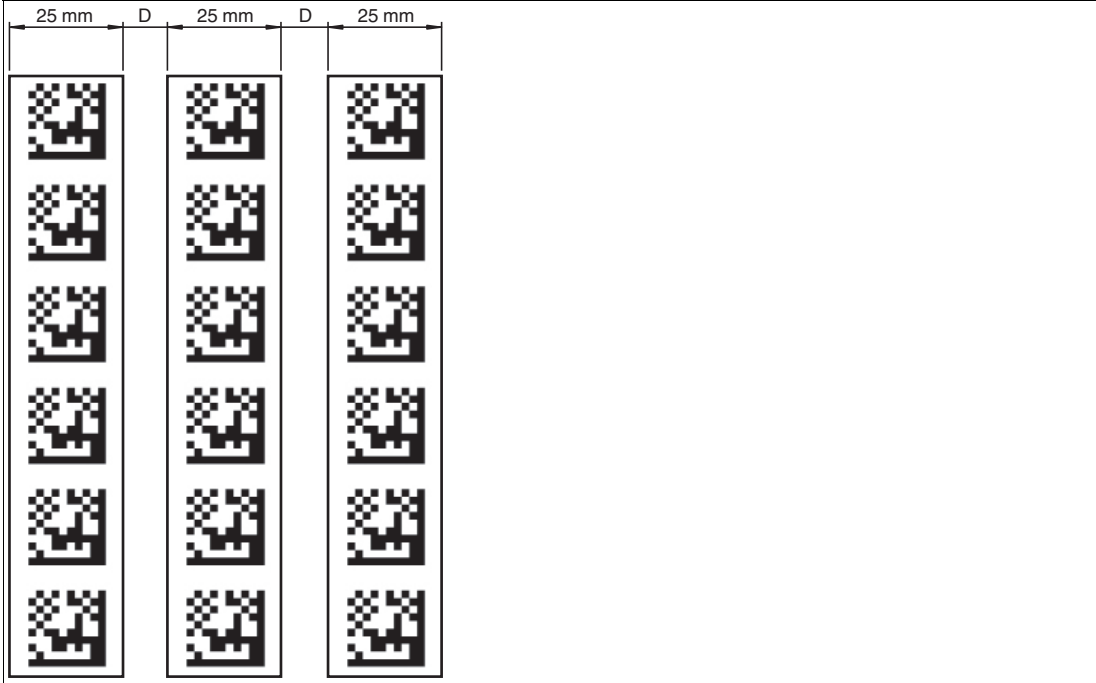

Figure 3.10  $0 \text{ mm} \leq D \leq 5 \text{ mm}$

### Data Matrix Tag (8 digit number)

A Data Matrix tag contains position information and a specific 8 digit number. A cross in the center of the Data Matrix tag marks the zero point. The X and the Y axes are marked starting from the zero point. The black arrow indicates the positive axis and the white arrow indicates the negative axis.

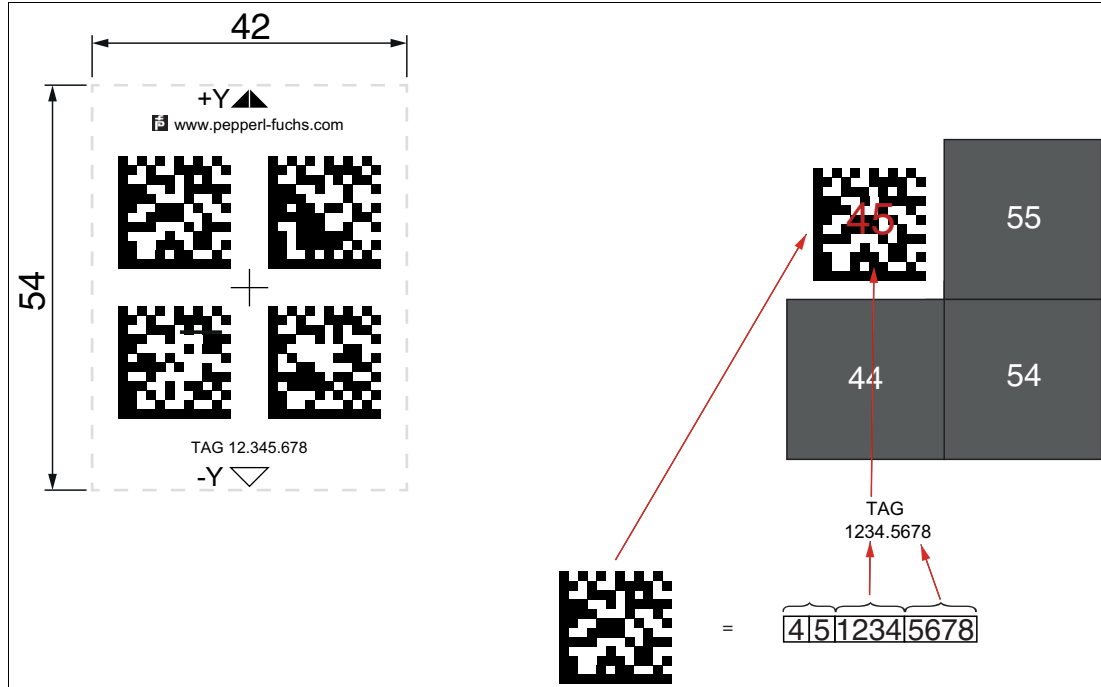

Figure 3.11 2x2 Data Matrix tag with the number 123456789 and position information

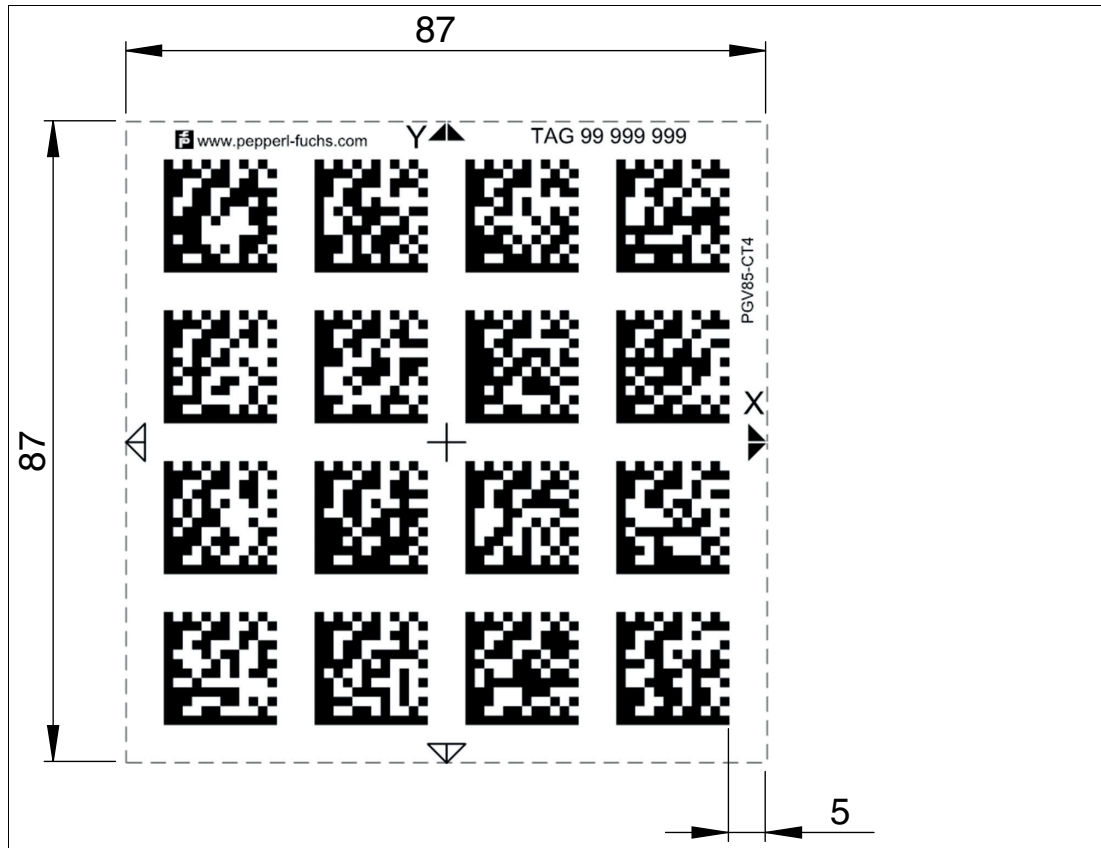

Figure 3.12 4x4 Data Matrix tag with the number 99999999 and position information

2023-07

### Data Matrix Tag — Extended (14 digit number)

A Data Matrix tag contains position information and a specific 14 digit number. A cross in the center of the Data Matrix tag marks the zero point. The X and the Y axes are marked starting from the zero point. The black arrow indicates the positive axis and the white arrow indicates the negative axis.

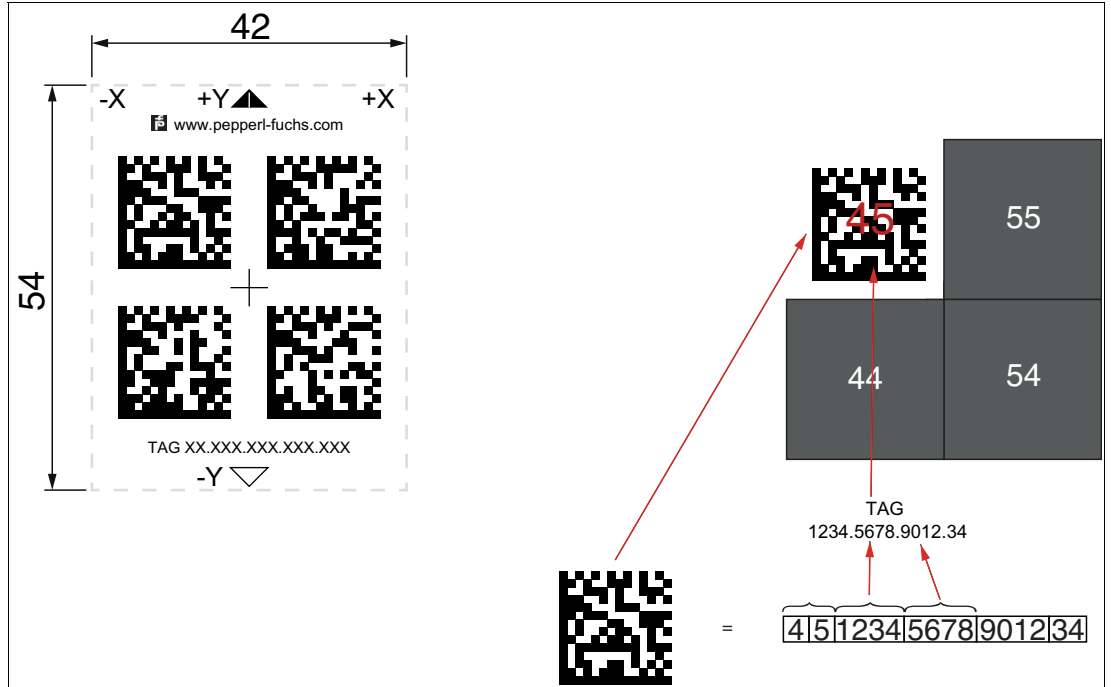

Figure 3.13 2x2 Data Matrix tag with number 12345678901234 and position information

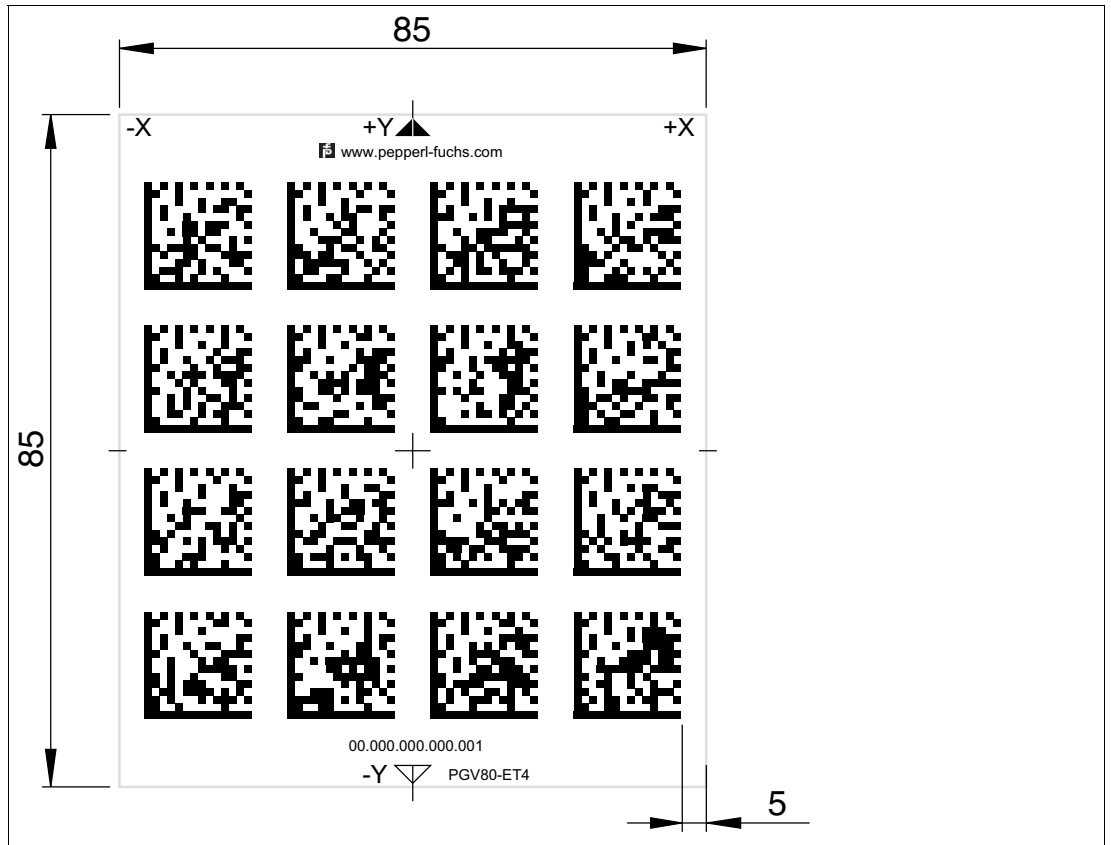

Figure 3.14 4x4 DataMatrix tag with the number 00000000000001 and position information

2023-07

### 3.3 Electrical Connection

The read head is connected electrically via a fixed cable with open cores on the side of the housing. The power is supplied via this connection. The configurable inputs and outputs on the read head are located at this connection.

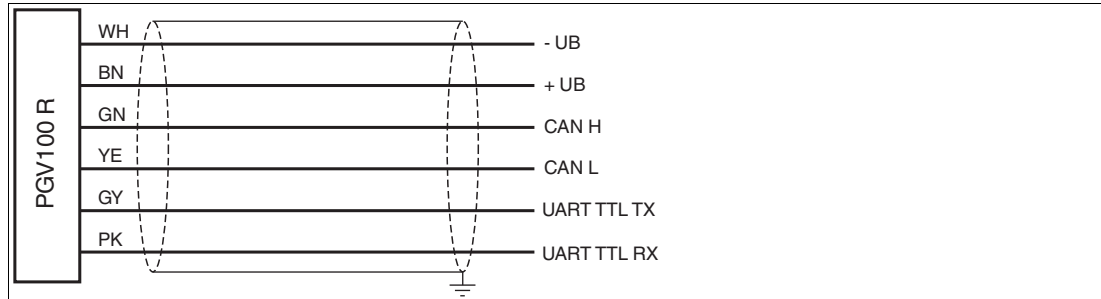

Figure 3.15 Electrical Connection

#### Color assignment

Strand color	Color abbreviation
White	WH
Brown	BN
Green	GN
Yellow	YE
Gray	GY
Pink	PK

Table 3.3 Color assignment

#### Shielding Cables

The shielding of connection lines is required to suppress electromagnetic interference. Establishing a low resistance or low impedance connection with the protective conductor or equipotential bonding circuit is a particularly important factor in ensuring that these interference currents do not become a source of interference themselves. Only use connection lines with braid. Avoid connection lines with foil shield because this would increase the line capacities. The shielding is integrated at both ends, i.e., in the switch cabinet or on the PLC, **and** on the read head. The grounding terminal available as an accessory allows easy integration in the equipotential bonding circuit.

In exceptional cases, the shielding of a connection at one end may be more favorable if:

- An equipotential bonding cable is not laid or cannot be laid.
- A film shield is used.

The following points relating to shielding must be noted:

- Use metal cable clips that cover large areas of the shielding.
- Place the cable shield onto the equipotential bonding rail immediately on entering the switch cabinet.
- Direct the protective grounding connections to a common point in a star configuration.
- The cross-section of the cables used for grounding should be as large as possible.



---

**Caution!**

Damage to the device

Connecting an alternating current or excessive supply voltage can damage the device or cause the device to malfunction.

Electrical connections with reversed polarity can damage the device or cause the device to malfunction.

Connect the device to direct current (DC). Ensure that the supply voltage rating is within the specified device range. Ensure that the connecting wires on the female cordset are connected correctly.

---

## 4 Commissioning

### 4.1 Direction Decision

The read head has several ways of following Data Matrix code tapes depending on the parameterization. Depending on the input signal, the read head follows the right-hand lane, the left-hand lane, or the better lane.

#### Direction Decision via Protocol

Direction control via the protocol.

#### Note

If direction decisions are made via the protocol, then subindex 12 "Input Source Selection" must be switched to Software in the global primary data.

#### Following the Lane with More Detailed Position Information

You can parameterize the read head so that it follows the Data Matrix code tape that continues the current location information.

#### Example

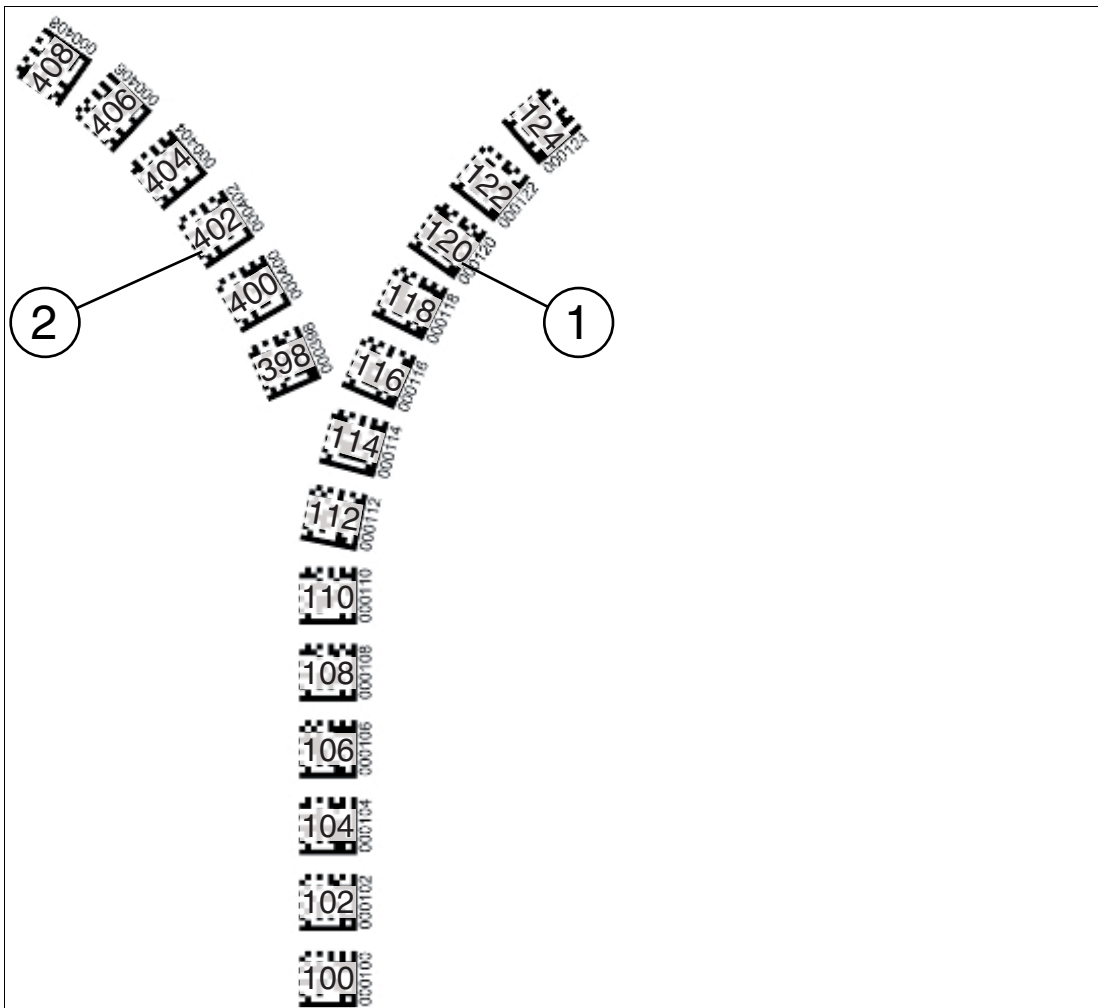

1. More detailed position information
2. New position information

## 4.2 Parameterization Using Code Cards

During parameterization, the read head scans special code cards optically and configures the relevant parameters. Simply hold the corresponding code cards at the correct distance in front of the lens on the read head. The standard code cards are in the appendix.



### Note

Parameterization mode can be activated in the first five minutes after voltage connection. A time lock disables the read head once this time has elapsed. If parameterization is required at a later time, switch off the supply voltage to the read head and switch it back on again. Parameterization mode can now be activated within the first five minutes. The time lock remains inactive during the parameterization process.



### Activating Parameterization Mode

1. To activate the read head, hold the "**ACTIVATE**" code card in the field of view of the read head's camera system.



### Note

The second parameterization code "USER" can be activated within the first **two minutes** after the first parameterization code "ACTIVATE" has been detected.

↳ After recognition of the parameterization code, the activation of the parameterization mode is enabled by the code card "USER". The read head can still be accessed by the controller.

2. To activate the read head, hold the "**USER**" code card in the field of view of the read head's camera system.

↳ Once the parameterization code has been detected, LED2 lights up green for 1 second. The read head is now in parameterization mode.



### Completing Parameterization

1. Place the parameterization code in the field of view of the camera module.

↳ Once the parameterization code has been detected, LED2 lights up green for 1 second. If the parameterization code is invalid, LED2 lights up red for 1 second.



### Exiting Parameterization Mode

1. Now hold the "**STORE**" code in front of the read head's camera system to save the configuration.

↳ When the "**STORE**" memory code is detected, the LED2 lights up green for 1 second. The parameterization is stored in the non-volatile memory of the read head and parameterization mode is terminated. Parameterization of the read head is now complete. If the memory code is not detected, LED2 lights up red for 1 second.



### Note

To save the parameters for the termination resistor, use the "Store Termination" code card, see chapter 6.4.

### 4.2.1 The code cards "CANCEL", "USE", and "DEFAULT"

Holding one of these cards in front of the reading head exits parameterization mode with the following consequences:

- **CANCEL:**  
All parameter changes that are made but have not yet been saved are discarded. The reading head operates with the last valid parameters that were saved.
- **USE:**  
For test purposes, the reading head operates with the parameters that have just been modified. The parameterization is not saved, however. After being switched off and on again, the reading head operates with the last valid parameters that were saved.
- **DEFAULT:**  
All parameters in the reading head are overwritten with the original default settings. Re-enter the configuration mode and save the default settings nonvolatile with the code card STORE.



## 5 Operation and communication

### 5.1 Data Exchange in the CANopen Bus

#### 5.1.1 General Information about CANopen

CANopen is a multimaster-compliant fieldbus system based on the CAN (**C**ontroller **A**rea **N**etwork).



Figure 5.1

Devices on the CANopen fieldbus communicate via message identifiers rather than via addresses. This allows all devices to access the fieldbus at any time. Fieldbus access is according to the CSMA/CA principle (**C**arrier **S**ense **M**ultiple **A**ccess/**C**ollision **A**voidance). Each device intercepts the fieldbus and can send messages whenever the fieldbus is free. If two devices start an access at the same time, the device with the highest priority, i.e., the lowest identifier, is assigned the access right. Devices with a lower priority interrupt the data transfer and make a further access attempt once the fieldbus becomes free.

Any device can receive the messages. An acceptance filter ensures that messages are received only by the intended devices. Data is transferred via message telegrams. Message telegrams consist of a COB ID (**C**ommunication **O**bject **I**dentifier) and a maximum of 8 subsequent bytes. The COB ID dictates the priority of the messages. The COB ID is made up of the function code and the node number.

The function code describes the message type:

- **Message with service data (SDO)**  
For parameterization of object directory entries
  - Any length
  - Cyclical transmission
  - SDOs of a device are combined in the object directory
  - Mailbox is placed on a (server) SDO, 36 bytes long
- **Message with process data (PDO)**  
For transmitting real-time data
  - Maximum 8 bytes long
  - Cyclical or event-controlled transmission
  - Distinction between send (max. 512) and receive PDOs (max. 512)
  - In the CAN, PDOs occupy their own identifier
- **Messages for network management (NMT)**  
For controlling the finite state machine of the CANopen device and for monitoring the nodes
  - Further objects such as synchronization object (SYNC), time stamp and error messages (EMCY).

The most important attributes of the process data objects (PDOs) and service data objects (SDOs) are shown in the table below.

Process data objects (PDOs)	Service data objects (SDOs)
Are used for real-time data exchange	Permit access to the object directory; each SDO assembles a point-to-point service communication channel.
Typically messages with high priority	Messages with lower priority
Synchronous and asynchronous data transfer	Typically asynchronous data transfer
Cyclical and noncyclical transmission	Typically noncyclical transmission
Data of the PDOs can be configured via SDOs	Use of the data field is dictated by the CMS (CAN Message Specification) Multiplexed Domain Protocol.
Preformatted data field	Access to an entry in the device object directory via index and subindex.

### Additional Information

CAN in Automation (CiA)  
International Users and Manufacturers Group e.V.  
Kontumazgarten 3  
90429 Nuremberg, Germany

<http://www.can-cia.org/>

- CiA Draft Standard V4.02
- CiA Draft Standard 303 LED-Behavior

## 5.1.2 Basic Technical Information about CANopen

### Connecting the Bus System

Within the CANopen network, all devices communicate via a 2-pin network cable. All devices are connected with the cable in parallel. To prevent interfering reflections within a network, you must connect a suitable terminator to each end.

### Device Profile

CANopen defines various device profiles for numerous device types. At present, the PGV100R-F200-B16\* read head does not correspond to any special device profile. The "Generic Device" profile is therefore assigned to the read head.

### Bus Length

The maximum line length within a CANopen network is dictated by the signal propagation delay. Communication within the network requires that signals are present on all bus nodes at the same time. The network can be adapted to the existing line lengths through various baud rates. The values in the table below serve as a reference point. The actual values may differ, depending on the applications concerned.

Baud rate [kBit/s]	Max. bus length [m]
1000	30
500	100
250	250
125	500
50	1000

Table 5.1 Bus Length

### Shielding

Ensure continuous shielding when cabling the read head.

## Startup Behavior

After switch-on, the read head in a CANopen network passes through several operating states.

1. **Initialization**  
Startup process of the read head.
2. **Preoperational**  
Read head state on completion of the startup process. The read head reports this state to the NMT master.
3. **Operational**  
Operative state of the read head. The NMT master sets this state via an NMT start node telegram once it has received the preoperational message from the read head.

## Exchange of Process Data

Within the CANopen network, process data is exchanged via process data objects (PDO). See chapter 5.1.1. Process data objects are divided into:

- **Transmit PDOs (TxPDO)**  
Process data objects that transmit input data and diagnostic data.
- **Receive PDOs (RxPDO)**  
Process data objects that transmit output data.

The first 4 PDOs per transmit or receive data packet transmit the default CAN identifier. All other PDOs of a data packet can be configured by the user.

## Communication Types

In the CANopen network, various communication types are specified for process data objects. The communication type of each PDO is controlled via the "Transmission Type" parameter. The "Transmission Type" parameter is defined in subindex 2 of the communication parameter object (from 0x1400) and is transmitted during the startup process via an SDO. See chapter 5.1.1.

The read head supports the following communication types:

"Transmission Type" parameter	Transmission	Description
0	Event-driven Synchronous	<b>TxPDO:</b> Data is detected upon receipt of a SYNC (= <b>S</b> ynchronization object). Data is transmitted only in the event of a change. <b>RxPDO:</b> Data is sent in an event-controlled manner and adopted in a SYNC.
1	Cyclic Synchronous	Data is adopted and transmitted cyclically at each nth SYNC. n = 1 ... 240th n can be individually assigned for each PDO to control transmission cycles.
241 ... 251	Reserved	
252 (TxPDO only)	Synchronous RTR (= <b>R</b> emote <b>T</b> ransmission <b>R</b> equest)	Data is detected upon receipt of a SYNC. Data is sent via RTR only on request.
253 (TxPDO only)	Asynchronous RTR	Data is detected and sent via RTR only on request.
254	Event-driven Manufacturer-specific	Read head sends data when "Operational" state is set and in the event of changes.
255	Event-driven Profile-specific	Read head sends data when "Operational" state is set and in the event of changes.

Table 5.2 "Transmission Type" parameter

## Communication Monitoring

To monitor bus communication, you can configure the following procedures in the read head.

- **Node guarding**

If you have configured the read head for node guarding, the NMT master sends guard telegrams that must be answered by the read head with the current CANopen status. The gap between the guard telegrams is defined in object 0x100C. .

If the read head does not send a response, a "Node Guard Event" is set. Node guarding is deactivated when you set the "Guard Time" in object 0x100C to 0.

- **Lifeguarding**

If you have configured the read head for lifeguarding, the read head sends lifeguard telegrams that must be answered by the NMT master. The gap between a lifeguard telegram and the response from the NMT master is defined in object 0x100D. .

If the guard telegram remains unanswered for the defined time, the read head sets a "Lifeguarding Event" and sends an EMCY telegram. Lifeguarding is deactivated when you set the "Guard Time" in object 0x100C or the "Life Time Factor" in object 0x100D to 0.

- **Heartbeat**

The read head can be configured both as emitter and receiver of a heartbeat telegram. If the read head is configured for sending a heartbeat telegram, this telegram will be monitored by the NMT master or a different bus node. If the read head is configured for receiving a heartbeat telegram, the read head monitors a different bus node or the NMT master. Configure heartbeat telegram transmission in object 0x1017. Specify the gap between the heartbeat telegrams via the "Heartbeat Producer Time." The heartbeat is deactivated when the "Heartbeat Producer Time" is set to 0.

Configure heartbeat telegram receipt in object 0x1016. Specify the gap between the heartbeat telegrams via the "Heartbeat Consumer Time." The heartbeat is deactivated when the "Heartbeat Consumer Time" is set to 0.

## Failsafe

Failsafe is the behavior of the read head when errors occur. The failsafe behavior is controlled via a parameter.

The behavior of the read head in the event of a CANopen error can be controlled via object 0x1029 "Behavior in the event of an error".

### 5.1.3 CANopen Object Directory



#### Note

#### CANopen Parameter Communication

This section contains the information required for the data exchange via CANopen. Data is exchanged with the reader via objects. These objects and their respective permissible functions are defined in the following SDO directory.

The reader supports the identifier format 2.0A (11-bit identifier) according to the CAN specification. The extended 29-bit identifier is not supported.

#### Supported Objects

Object	Description
0x1000	Device Type
0x1001	Error Register
0x1005	SYNC Identifier
0x1008	Manufacturer Device Name
0x1009	Manufacturer Hardware Version
0x100A	Manufacturer Software Version
0x100C	Guard Time
0x100D	Life Time Factor
0x1012	COB-ID Time Stamp
0x1014	COB-ID Emergency
0x1015	Inhibit Time Emergency
0x1016	Heartbeat Consumer Entries
0x1017	Producer Heartbeat Time
0x1018	Identity Object
0x1029	Behavior in the Event of an Error
0x1200	1. Server SDO parameter (default SDO)
0x1400	1. RxPDO Input Data
0x1600	Receive PDO 1 mapping
0x1800	1. TxPDO Y Data, Status, Warning
0x1801	2. TxPDO X Data, Angle
0x1802	3. TxPDO TAG Data
0x1803	4. TxPDO Control Code Status, Control Code, Timestamp
0x1804	5. TxPDO Z Distance
0x1A00	Send PDO 1 mapping
0x1A01	Send PDO 2 mapping
0x1A02	Send PDO 3 mapping
0x1A03	Send PDO 4 mapping
0x1A04	Send PDO 5 mapping
0x2000	Position data and status data
0x2200	Input data
0x3000	Serial Number
0x3001	Parameterization object

The device-specific object directory OV contains all parameters and process data for the reader. The parameters and process data are listed in tables. The object directory has two defined areas. In the first area, the reader is described in general terms. The device ID, the name of the manufacturer, and the communication parameters are listed here. In the second area, the specific functionality of the reader is described.

An entry in the object list is identified via a 16-bit index and an 8-bit subindex. Access to device parameters and process data, such as input signals and output signals, device functions, and network variables, is provided via the assignment within the object list in standardized form over the CANopen network.

### Device Type

Index	Subindex	Description	Data type	Attribute	PDO mapping possible	Default value
0x1000	0x00	Device Type	unsigned32 <sup>1</sup>	ro (= read only)	no	0x0

Table 5.3 The device type of the reader is 0x00000000, since no specific device profile is implemented.

1. Data type without prefix, 32 bit

### Error Register

Index	Subindex	Description	Data type	Attribute	PDO mapping possible	Default value
0x1001	0x00	Error Register	unsigned8	ro	no	0x0

The 8-bit data of the error register describes errors as follows:

Bit							
7	6	5	4	3	2	1	0
0	Reserved	Reserved	Communication errors	Reserved	Reserved	Reserved	Generic error not specified in more detail <sup>1</sup>

1. Flag is set for every error message

### SYNC Identifier

Index	Subindex	Description	Data type	Attribute	PDO mapping possible	Default value
0x1005	0x00	COB-ID SYNC Message	unsigned32	rw (= read/write)	no	0x00000080

The 32-bit data of the identifier in the SYNC message describes the synchronization as follows:

Bit			
31	30	...	10 ... 0
Has no meaning	0 <sup>1</sup>	...	Identifier 0x80 = 128 <sub>dec</sub>

1. Always 0, since reader is only for SYNC consumers, not SYNC producers

**Manufacturer Device Name**

Index	Subindex	Description	Data type	Attribute	PDO mapping possible	Default value
0x1008	0x00	Manufacturer Device Name	visible string <sup>1</sup>	ro	no	-

1. ASCII string, variable length

**Manufacturer Hardware Version**

Index	Subindex	Description	Data type	Attribute	PDO mapping possible	Default value
0x1009	0x00	Manufacturer Hardware Version	visible string	ro	no	-

**Manufacturer Software Version**

Index	Subindex	Description	Data type	Attribute	PDO mapping possible	Default value
0x100A	0x00	Manufacturer Software Version	visible string	ro	no	-

**Guard Time**

Index	Subindex	Description	Data type	Attribute	PDO mapping possible	Default value
0x100C	0x00	Guard Time [ms]	unsigned16	rw	no	0x0

**Life Time Factor**

Index	Subindex	Description	Data type	Attribute	PDO mapping possible	Default value
0x100D	0x00	Life Time Factor	unsigned8	rw	no	0x0

Table 5.4 Life time factor x guard time = life time (watchdog for life guarding - master monitoring)

**COB-ID Time Stamp**

Index	Subindex	Description	Data type	Attribute	PDO mapping possible	Default value
0x1012	0x00	COB-ID Time Stamp	unsigned32	rw	no	0x80000100

**COB-ID Emergency**

Index	Subindex	Description	Data type	Attribute	PDO mapping possible	Default value
0x1014	0x00	COB-ID Emergency	unsigned32	rw	no	NODEID + 0x80

### Inhibit Time Emergency

Index	Subindex	Description	Data type	Attribute	PDO mapping possible	Default value
0x1015	0x00	Inhibit Time Emergency	unsigned16	rw	no	0x0

### Heartbeat Consumer Entries

Index	Subindex	Description	Data type	Attribute	PDO mapping possible	Default value
0x1016	0x00	Number of Subsequent Parameters	unsigned8	ro	no	0x40
	0x01 ... 0x40	Consumer Heartbeat Time <sup>1</sup>	unsigned32	rw	no	0x0

1. Expected heartbeat cycle time [ms] and node ID of the monitored bus node

The monitored identifier guard ID results from the default identifier distribution: Guard ID = 0x700 + node ID

Bit		
31 ... 24	23 ... 16	15 ... 0
Reserved <sup>1</sup>	NOTEID	Heartbeat Time [ms]

1. Always 0

### Producer Heartbeat Time

Index	Subindex	Description	Data type	Attribute	PDO mapping possible	Default value
0x1017	0x00	Producer Heartbeat Time <sup>1</sup>	unsigned16	rw	no	0x0

1. Time [ms] between two sent heartbeat telegrams

### Identity Object

Index	Subindex	Description	Data type	Attribute	PDO mapping possible	Default value
0x1018	0x00	Number of Subsequent Parameters	unsigned8	ro	no	0x4
	0x01	Manufacturer Identifier	unsigned32	ro	no	0xAD
	0x02	Device Identifier	unsigned32	ro	no	0x6
	0x03	Version Number	unsigned32	ro	no	0x1
	0x04	Serial Number	unsigned32	ro	no	0x0



**Behavior in the Event of an Error**

Index	Subindex	Description	Data type	Attribute	PDO mapping possible	Default value
0x1029	0x00	Number of Subsequent Parameters	unsigned8	ro	no	0x01
	0x01	Communication Error <sup>1</sup>	unsigned8	rw	no	0x0

1. For procedure in case of communication errors, see the table below

Data bit	Procedure in case of communication errors
0x00	Reader changes from <b>Operational</b> to <b>Preoperational</b>
0x01	Reader retains current status
0x02	Reader changes to <b>Stopped</b>

**Server SDO Parameter 0**

Index	Subindex	Description	Data type	Attribute	PDO mapping possible	Default value
0x1200	0x00	Number of Subsequent Parameters	unsigned8	ro	no	0x02
	0x01	COB ID Client to Server	unsigned32	ro	no	NODEID + 0x600
	0x02	COB ID Server to Client	unsigned32	ro	no	NODEID + 0x580

**1. RxPDO Input Data**

Index	Subindex	Description	Data type	Attribute	PDO mapping possible	Default value
0x1400	0x00	Number of Subsequent Parameters	unsigned8	ro	no	0x02
	0x01	COB ID used by RPDO	unsigned32	rw	no	NODEID + 0x200
	0x02	Transmission Type	unsigned8	rw	no	0xFE

COB ID: Bit			
31	30	29 ... 11	10 ... 0
PDO present: 0 = currently present 1 = not present	RTR access: 0 = permitted 1 = not permitted	...	CAN identifier <sup>1</sup>

1. Cannot be changed when PDO is currently present

## 1. TxPDO Y-Data, Status, Warning

Index	Subindex	Description	Data type	Attribute	PDO mapping possible	Default value
0x1800	0x00	Number of Subsequent Parameters	unsigned8	ro	no	0x5
	0x01	COB ID	unsigned32	rw	no	NODEID + 0x180
	0x02	Transmission Type	unsigned8	rw	no	0xFE
	0x03	Inhibit Time	unsigned16	rw	no	0x0
	0x04	Compatibility Entry	unsigned8	rw	no	0x0
	0x05	Event Timer	unsigned16	rw	no	0x0

COB ID: Bit			
31	30	29 ... 11	10 ... 0
PDO present: 0 = currently present 1 = not present	RTR access: 0 = permitted 1 = not permitted	...	CAN identifier <sup>1</sup>

1. Cannot be changed when PDO is currently present

## 2. TxPDO X Data, Angle

Index	Subindex	Description	Data type	Attribute	PDO mapping possible	Default value
0x1801	0x00	Number of Subsequent Parameters	unsigned8	ro	no	0x5
	0x01	COB ID	unsigned32	rw	no	NODEID + 0x280
	0x02	Transmission Type	unsigned8	rw	no	0xFE
	0x03	Inhibit Time	unsigned16	rw	no	0x0
	0x04	Compatibility Entry	unsigned8	rw	no	0x0
	0x05	Event Timer	unsigned16	rw	no	0x0

COB ID: Bit			
31	30	29 ... 11	10 ... 0
PDO present: 0 = currently present 1 = not present	RTR access: 0 = permitted 1 = not permitted	...	CAN identifier <sup>1</sup>

1. Cannot be changed when PDO is currently present

## 3. TxPDO TAG Data

Index	Subindex	Description	Data type	Attribute	PDO mapping possible	Default value
0x1802	00x0	Number of Subsequent Parameters	unsigned8	ro	no	0x5
	0x01	COB ID	unsigned32	rw	no	NODEID + 0x380
	0x02	Transmission Type	unsigned8	rw	no	0xFE
	0x03	Inhibit Time	unsigned16	rw	no	0x0
	0x04	Compatibility Entry	unsigned8	rw	no	0x0
	0x05	Event Timer	unsigned16	rw	no	0x0

## COB ID: Bit

31	30	29 ... 11	10 ... 0
PDO present: 0 = currently present 1 = not present	RTR access: 0 = permitted 1 = not permitted	...	CAN identifier <sup>1</sup>

1. Cannot be changed when PDO is currently present

## 4. TxPDO Control Code Status, Control Code, Timestamp

Index	Subindex	Description	Data type	Attribute	PDO mapping possible	Default value
0x1803	0x00	Number of Subsequent Parameters	unsigned8	ro	no	0x5
	0x01	COB ID	unsigned32	rw	no	NODEID + 0x480
	0x02	Transmission Type	unsigned8	rw	no	0xFE
	0x03	Inhibit Time	unsigned16	rw	no	0x0
	0x04	Compatibility Entry	unsigned8	rw	no	0x0
	0x05	Event Timer	unsigned16	rw	no	0x0

## COB ID: Bit

31	30	29 ... 11	10 ... 0
PDO present: 0 = currently present 1 = not present	RTR access: 0 = permitted 1 = not permitted	...	CAN identifier <sup>1</sup>

1. Cannot be changed when PDO is currently present

## 5. TxPDO Z Distance

Index	Subindex	Description	Data type	Attribute	PDO mapping possible	Default value
0x1804	0x00	Number of Subsequent Parameters	unsigned8	ro	no	0x5
	0x01	COB ID	unsigned32	rw	no	0x80000000
	0x02	Transmission Type	unsigned8	rw	no	0xFE
	0x03	Inhibit Time	unsigned16	rw	no	0x0
	0x04	Compatibility Entry	unsigned8	rw	no	0x0
	0x05	Event Timer	unsigned16	rw	no	0x0

COB ID: Bit			
31	30	29 ... 11	10 ... 0
PDO present: 0 = currently present 1 = not present	RTR access: 0 = permitted 1 = not permitted	...	CAN identifier <sup>1</sup>

1. Cannot be changed when PDO is currently present

## Mapping 1. RxPDO

Index	Subindex	Description	Data type	Attribute	PDO mapping possible	Default value	Meaning <sup>1</sup>
0x1600	0x00	Number of Subsequent Parameters	unsigned8	rw	no	0x08	Number of mapped objects
	0x01	Mapping of Input Data	unsigned32	rw	no	0x22000108	<b>Input Data</b> MSB Data = 0x2200, byte 0x01
	0x02	Reserved	unsigned32	rw	no	0x22000208	Reserved
	0x03	Reserved	unsigned32	rw	no	0x22000308	Reserved
	0x04	Reserved	unsigned32	rw	no	0x22000408	Reserved
	0x05	Reserved	unsigned32	rw	no	0x22000508	Reserved
	0x06	Reserved	unsigned32	rw	no	0x22000608	Reserved
	0x07	Reserved	unsigned32	rw	no	0x22000708	Reserved
	0x08	Reserved	unsigned32	rw	no	0x22000808	Reserved

1. Application objects: 2-byte index, 1-byte subindex, 1-byte number of bits

Mapping 1. TxPDO

Index	Subindex	Description	Data type	Attribute	PDO mapping possible	Default value	Meaning <sup>1</sup>
0x1A00	0x00	Number of Subsequent Parameters	unsigned8	rw	no	0x08	Number of mapped objects
	0x01	Mapping of YP24-YP31	unsigned32	rw	no	0x20000108	<b>Y position data YP24-YP31</b> MSB Data = 0x2000, byte 0x01 1. Bit = sign bit
	0x02	Mapping of YP16-YP23	unsigned32	rw	no	0x20000208	<b>Y position data YP16-YP23</b> MSB Data = 0x2000, byte 0x02 1. Bit = sign bit
	0x03	Mapping of YP08-YP15	unsigned32	rw	no	0x20000308	<b>Y position data YP08-YP15</b> MSB Data = 0x2000, byte 0x03 1. Bit = sign bit
	0x04	Mapping of YP00-YP07	unsigned32	rw	no	0x20000408	<b>Y position data YP00-YP07</b> LSB Data = 0x2000, byte 0x04 1. Bit = sign bit
	0x05	Mapping of ST08-ST15	unsigned32	rw	no	0x20001108	<b>Status ST08-ST15</b> MSB Data = 0x2000, Byte 0x11
	0x06	Mapping of ST00-ST07	unsigned32	rw	no	0x20001208	<b>Status ST00-ST07</b> MSB Data = 0x2000, Byte 0x12
	0x07	Mapping of WRN08-WRN15	unsigned32	rw	no	0x20001308	<b>Warning WRN08-WRN15</b> MSB Data = 0x2000, Byte 0x13
	0x08	Mapping of WRN00-WRN07	unsigned32	rw	no	0x20001408	<b>Warning WRN00-WRN07</b> LSB Data = 0x2000, Byte 0x14

1. Application objects: 2-byte index, 1-byte subindex, 1-byte number of bits

## Mapping 2. TxPDO

Index	Subindex	Description	Data type	Attribute	PDO mapping possible	Default value	Meaning <sup>1</sup>
0x1A01	0x00	Number of Subsequent Parameters	unsigned8	rw	no	0x08	Number of mapped objects
	0x01	Mapping of XP24-XP31	unsigned32	rw	no	0x20000908	<b>X position data XP24-XP31</b> MSB Data = 0x2000, byte 0x09
	0x02	Mapping of XP16-XP23	unsigned32	rw	no	0x20000A08	<b>X position data XP16-XP23</b> MSB Data = 0x2000, byte 0x0A
	0x03	Mapping of XP08-XP15	unsigned32	rw	no	0x20000B08	<b>X position data XP08-XP15</b> MSB Data = 0x2000, byte 0x0B
	0x04	Mapping of XP00-XP07	unsigned32	rw	no	0x20000C08	<b>X position data XP00-XP07</b> LSB Data = 0x2000, byte 0x0C
	0x05	Mapping of AG08-AG15	unsigned32	rw	no	0x20000D08	<b>Angle AG08-AG15</b> MSB Data = 0x2000, byte 0x0D
	0x06	Mapping of AG00-AG07	unsigned32	rw	no	0x20000E08	<b>Angle AG00-AG07</b> LSB Data = 0x2000, byte 0x0E
	0x07	Reserved	unsigned32	rw	no	0x20000F08	Reserved
	0x08	Reserved	unsigned32	rw	no	0x20001008	Reserved

1. Application objects: 2-byte index, 1-byte subindex, 1-byte number of bits

Mapping 3. TxPDO

Index	Subindex	Description	Data type	Attribute	PDO mapping possible	Default value	Meaning <sup>1</sup>
0x1A02	0x00	Number of Subsequent Parameters	unsigned8	rw	no	0x08	Number of mapped objects
	0x01	Mapping of TAG56 - TAG63	unsigned32	rw	no	0x20001D08	<b>Data-Matrix-Tag TAG56-TAG63</b> MSB Data = 0x2000, byte 0x1D
	0x02	Mapping of TAG48 - TAG55	unsigned32	rw	no	0x20001E08	<b>Data-Matrix-Tag TAG48-TAG55</b> MSB Data = 0x2000, byte 0x1E
	0x03	Mapping of TAG40 - TAG47	unsigned32	rw	no	0x20001F08	<b>Data-Matrix-Tag TAG40-TAG47</b> MSB Data = 0x2000, byte 0x1F
	0x04	Mapping of TAG32 - TAG39	unsigned32	rw	no	0x20002008	<b>Data Matrix tag TAG32-TAG39</b> LSB Data = 0x2000, byte 0x20
	0x05	Mapping of TAG24 - TAG31	unsigned32	rw	no	0x20001508	<b>Data Matrix tag TAG24-TAG31</b> MSB Data = 0x2000, byte 0x15
	0x06	Mapping of TAG16 - TAG23	unsigned32	rw	no	0x20001608	<b>Data Matrix tag TAG16-TAG23</b> MSB Data = 0x2000, byte 0x16
	0x07	Mapping of TAG08 - TAG15	unsigned32	rw	no	0x20001708	<b>Data Matrix tag TAG08-TAG15</b> MSB Data = 0x2000, byte 0x17
	0x08	Mapping of TAG00 - TAG07	unsigned32	rw	no	0x20001808	<b>Data Matrix tag TAG00-TAG07</b> MSB Data = 0x2000, byte 0x18

1. Application objects: 2-byte index, 1-byte subindex, 1-byte number of bits

## Mapping 4. TxPDO

Index	Subindex	Description	Data type	Attribute	PDO mapping possible	Default value	Meaning <sup>1</sup>
0x1A03	0x00	Number of Subsequent Parameters	unsigned8	rw	no	0x08	Number of mapped objects
	0x01	Mapping of STCC00 -STCC07	unsigned32	rw	no	0x20001908	<b>Status control code STCC1_00-STCC1_07</b> MSB Data = 0x2000, byte 0x19
	0x02	Mapping of CC08-CC15	unsigned32	rw	no	0x20001A08	<b>Control code CC1_08-CC1_15</b> MSB Data = 0x2000, byte 0x1A
	0x03	Mapping of CC00-CC07	unsigned32	rw	no	0x20001B08	<b>Control code CC1_00-CC1_07</b> LSB Data = 0x2000, byte 0x1B
	0x04	Reserved	unsigned32	rw	no	0x20001C08	Reserved
	0x05	Mapping of TS24-TS31	unsigned32	rw	no	0x20000508	<b>Timestamp TS_24 - TS_31</b> Data = 0x2000, Byte 0x05
	0x06	Mapping of TS16-TS23	unsigned32	rw	no	0x20000608	<b>Timestamp TS_16 - TS_23</b> Data = 0x2000, Byte 0x06
	0x07	Mapping of TS08-TS15	unsigned32	rw	no	0x20000708	<b>Timestamp TS_08 - TS_15</b> Data = 0x2000, Byte 0x07
	0x08	Mapping of TS00-TS07	unsigned32	rw	no	0x20000808	<b>Timestamp TS_00 - TS_07</b> Data = 0x2000, Byte 0x08

1. Application objects: 2-byte index, 1-byte subindex, 1-byte number of bits



**Mapping 5. TxPDO**

Index	Subindex	Description	Data type	Attribute	PDO mapping possible	Default value	Meaning <sup>1</sup>
0x1A04	0x00	Number of Subsequent Parameters	unsigned8	rw	no	0x08	Number of mapped objects
	0x01	Mapping of Z08 - Z15	unsigned32	rw	no	0x20002108	<b>Z distance data Z08-Z15</b> MSB Data = 0x2000, Byte 0x21
	0x02	Mapping of Z00 - Z07	unsigned32	rw	no	0x20002208	<b>Z distance data Z00-Z07</b> LSB Data = 0x2000, Byte 0x22
	0x03	Reserved	unsigned32	rw	no	0x20002308	Reserved
	0x04	Reserved	unsigned32	rw	no	0x20002408	Reserved
	0x05	Reserved	unsigned32	rw	no	0x20002508	Reserved
	0x06	Reserved	unsigned32	rw	no	0x20002608	Reserved
	0x07	Reserved	unsigned32	rw	no	0x20002708	Reserved
	0x08	Reserved	unsigned32	rw	no	0x20002808	Reserved

1. Application objects: 2-byte index, 1-byte subindex, 1-byte number of bits

**Position data and status data**

Index	Subindex	Description	Data type	Attribute	PDO mapping possible	Default value	Meaning
0x2000	0x00	Number of Subsequent Parameters	unsigned8	rw	no	0x28	Number of mapped objects
	0x00 - 0x28	Position data and status data	unsigned8	ro	yes	0x0	Position data and status data

Index	Sub-index	7	6	5	4	3	2	1	0
0x2000	0x01	YP31	YP30	YP29	YP28	YP27	YP26	YP25	YP24
	0x02	YP23	YP22	YP21	YP20	YP19	YP18	YP17	YP16
	0x03	YP15	YP14	YP13	YP12	YP11	YP10	YP09	YP08
	0x04	YP07	YP06	YP05	YP04	YP03	YP02	YP01	YP00
	0x05	TS31	TS30	TS29	TS28	TS27	TS26	TS25	TS24
	0x06	TS23	TS22	TS21	TS20	TS19	TS18	TS17	TS16
	0x07	TS15	TS14	TS13	TS12	TS11	TS10	TS09	TS08
	0x08	TS07	TS06	TS05	TS04	TS03	TS02	TS01	TS00
	0x09	XP31	XP30	XP29	XP28	XP27	XP26	XP25	XP24
	0x0A	XP23	XP22	XP21	XP20	XP19	XP18	XP17	XP16
	0x0B	XP15	XP14	XP13	XP12	XP11	XP10	XP09	XP08
	0x0C	XP07	XP06	XP05	XP04	XP03	XP02	XP01	XP00
	0x0D	AG15	AG14	AG13	AG12	AG11	AG10	AG09	AG08
	0x0E	AG07	AG06	AG05	AG04	AG03	AG02	AG01	AG00
	0x0F	reserved							
	0x10	reserved							
	0x11	0	0	0	FlashOff	TAG <sup>1</sup>	0	0	0
	0x12	1	LT	RT	0	CC1	WRN	NP	ERR
	0x13	WRN15	WRN14	WRN13	WRN12	WRN11	WRN10	WRN09	WRN08
	0x14	WRN07	WRN06	WRN05	WRN04	WRN03	WRN02	WRN01	WRN00
	0x15	TAG31	TAG30	TAG29	TAG28	TAG27	TAG26	TAG25	TAG24
	0x16	TAG23	TAG22	TAG21	TAG20	TAG19	TAG18	TAG17	TAG16
	0x17	TAG15	TAG14	TAG13	TAG12	TAG11	TAG10	TAG09	TAG08
	0x18	TAG07	TAG06	TAG05	TAG04	TAG03	TAG02	TAG01	TAG00
	0x19	reserved				O1_1	O1_0	S1_1	S1_0
	0x1A	CC1_15	CC1_14	CC1_13	CC1_12	CC1_11	CC1_10	CC1_09	CC1_08
	0x1B	CC1_07	CC1_06	CC1_05	CC1_04	CC1_03	CC1_02	CC1_01	CC1_00
	0x1C	reserved							
	0x1D	TAG63	TAG62	TAG61	TAG60	TAG59	TAG58	TAG57	TAG56
	0x1E	TAG55	TAG54	TAG53	TAG52	TAG51	TAG50	TAG49	TAG48
	0x1F	TAG47	TAG46	TAG45	TAG44	TAG43	TAG42	TAG41	TAG40
	0x20	TAG39	TAG38	TAG37	TAG36	TAG35	TAG34	TAG33	TAG32
	0x21	Z15	Z14	Z13	Z12	Z11	Z10	Z09	Z08
	0x22	Z07	Z06	Z05	Z04	Z03	Z02	Z01	Z00
	0x23	reserved							
	0x24	reserved							
	0x25	reserved							
	0x26	reserved							
	0x27	reserved							
	0x28	reserved							

1. Bei Bit = 1: Lesekopf erkennt DataMatrix-Tag

2023-07

### Input Data

Index	Subindex	Description	Data type	Attribute	PDO mapping possible	Default value	Meaning
0x2200	0x00	Number of Subsequent Parameters	unsigned8	ro	no	0x08	Number of mapped objects
	0x01 ... 0x08	Position data and status data	unsigned8	wo	yes	0x0	Position data and status data

Index	Sub-index	7	6	5	4	3	2	1	0
0x2200	0x00	Number of Subsequent Parameters							
	0x01	0	0	0	I_Ctrl	0	0	Input_Dir_Sel_Right	Input_Dir_Sel_Left
	0x02	reserved							
	0x03	reserved							
	0x04	reserved							
	0x05	reserved							
	0x06	reserved							
	0x07	reserved							
	0x08	reserved							

Description	Function
AG#	Absolute angle specification
CC1_#/CC2_#	Control code 1 or 2 with number # detected Control code 2 is evaluated via the "Split value" function. <sup>1</sup>
CC1	Associated control code is detected.
ERR	Error message Error codes are stored in XP00 ... XP23. Additional information on the codes can be found in the <b>Error Codes</b> table.
LT/RT	Selected direction decision
NP	No absolute X position
O1_#/O2_#	Orientation control code for lane. Refer to section " <b>Orientation O</b> " (see chapter 5.1.3.1).
S1_#/S2_#	Relative position control code for lane. Refer to section " <b>Side S</b> " (see chapter 5.1.3.2).
TAG	Data Matrix tag detected
TAG#	Data Matrix tag with number # detected
WRN	Warning message Warnings are stored in WRN00 ... WRN13. Additional information on the codes can be found in the <b>Warning Messages</b> table.
XP#	Absolute position in the X direction, signed
YP#	Absolute position in the Y direction, signed
Z#	Distance of the read head to the code tape/ TAG in Z direction
TS#	Timestamp of image acquisition 32 bit unsigned (37.04 ns steps) (Overflow after 159.07s)
FlashOff	Status bit flash deactivated (1: flash off, 0: flash on)

2023-07

Description	Function
I_Ctrl	Status bit flash (1: flash off, 0: flash on)

Table 5.5

1. Should you have any questions, please contact Pepperl+Fuchs

### Error Codes

Error code	Description	Priority
2	No clear position can be determined, e.g., difference between codes is too great, code distance incorrect	4
5	No direction decision available	2
> 1000	Internal fault	1

### Warning Messages

Warning code	Warning message	Description	Priority
WRN00	1	A code with non-PGV content was found.	3
WRN01	2	Reader too close to code tape	4
WRN02	3	Reader too far from code tape	5
WRN03	4	Reserved	6
WRN04	5	Reserved	7
WRN05	6	The reader is rotated or tilted in relation to the code tape	8
WRN06	7	Reserved	9
WRN07	8	Reserved	1
WRN08	9	Reserved	2
WRN09	10	Position code near branch/crossover detected	10
WRN10	11	More than the specified number of code lanes present	11
WRN11	12	Selected lane not visible. The position data originates from another lane in the field of view.	-
WRN12	13	Reserved	-
WRN13	14	Reserved	-
WRN14	15	Reserved	-
WRN15	16	Reserved	-

Table 5.6 If no warning messages are present, all bits in the warning data set are set to 0.

### Serial Number

Index	Subindex	Description	Data type	Attribute	PDO mapping possible	Value
0x3000	0x00	Serial Number	ASCII string	ro	no	Serial number

### 5.1.3.1 Orientation O

The orientation O indicates the orientation of the control codes in the reading window.

#### Meaning of Bits

O1	O0	Meaning
0	0	Control code has the same orientation as ascending Data Matrix lane
0	1	Orientation of control code rotated 90° clockwise in relation to ascending Data Matrix lane
1	0	Orientation of control code rotated 180° clockwise in relation to ascending Data Matrix lane
1	1	Orientation of control code rotated 270° clockwise in relation to ascending Data Matrix lane

#### Orientation

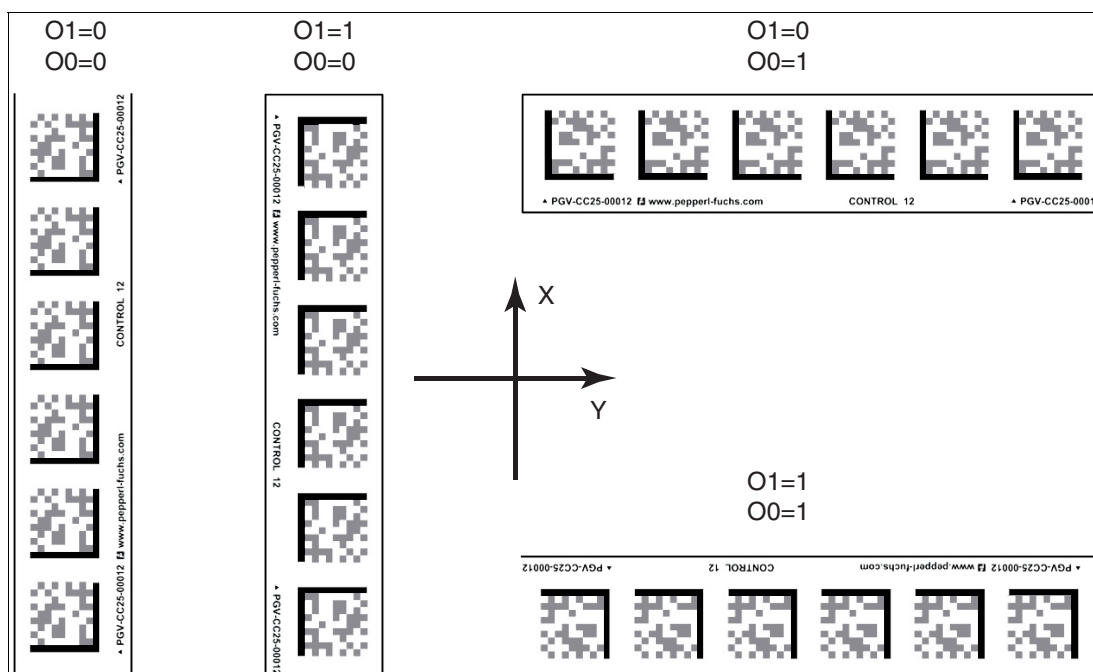

Figure 5.2

### 5.1.3.2 Side S

Side S specifies the side of the Data Matrix lane on which the control codes are present.

#### Meaning of Bits

S1	S0	Meaning
0	0	No control code is present or found Reserved
0	1	Control code to the right of the Data Matrix lane
1	0	Control code to the left of the Data Matrix lane
1	1	Not detectable <sup>1</sup>

Table 5.7 Meaning of bits S1 and S0

1. Control code laid on Data Matrix lane  
 No Data Matrix lane available

### 5.1.3.3 Position/Lane

You can use the following table to draw conclusions on the current section in the reading window from the feedback of the read head regarding Data Matrix **TAG**, No X Position **NP**, absolute X position **XP** and the Y position and angle **YPS/ANG**.

#### Meaning of Bits

TAG	NP	XP	YPS/ANG	Meaning
0	0	+	+	Data Matrix lane.
0	1	-	-	No evaluable objects exist.
1	0	+	+	Position on the basis of a Data Matrix tag, X position is signed.

### 5.1.4 LSS Service

The read head supports changing the baud rate as well as the Node-ID via CANopen using Layer Setting Service (LSS).

### 5.1.5 Object 3001

Global primary data allows you to parameterize the reader using CANopen. Global primary data is always transferred to the reader in full.

Sub-index	Designation	Function	Parameter data	Data type	Primary data
0	Number of subsequent parameters			unsigned8	11
1	X resolution	Multiplier for the length in the direction of the X coordinate	Resolution	unsigned32	0x00: 0.1 mm 0x01: 1 mm 0x02: 10 mm
2	Y resolution	Multiplier for the length in the direction of the Y coordinate	Resolution	unsigned32	0x00: 0.1 mm 0x01: 1 mm 0x02: 10 mm
3	Angle Resolution	Multiplier for the angle output	Resolution	signed32	-16384 – 16384 360
4	Horizontal Offset	Offset in the direction of the X coordinate	Length	signed32	0 mm – ±10,000,000 mm
5	Vertical Offset	Offset in the direction of the Y coordinate	Length	signed32	0 mm – ±10,000,000 mm
6	Angle Offset	Line of vision offset	Angle	signed32	-16383 – 0 mm – 16383
7	No Position Value X	X value if no code tape is visible	X data at "No Position"	octet_string Octet 0-3	Last Valid Position (0) Specified Value (1)
	No Position Specific X Position	Specific X value		Octet 4-7	-2147483648 – 0 – 2147483647

2023-07

Sub-index	Designation	Function	Parameter data	Data type	Primary data
8	No Position Value Y	Y value if no code tape is visible	Y data at "No Position"	octet_string Octet 0-3	Last Valid Position (0) Specified Value (1)
	No Position Specific Y Position	Specific Y value		Octet 4-7	-32768 – 0 – 32767
9	No Position Value Angle	Angle output if no colored tape is visible	Angle data at "No Position"	octet_string Octet 0-3	Last Valid Angle (0) Specified Angle (1)
	No Position Specific Angle Position	Fixed angle		Octet 4-7	0 – 65535
10	Reserved				
11	Reserved				
12	Input Source Selection	Selection of the source of the input data	Selection	unsigned32	0 = Hardware Input 1 = Software (PDO)

## 5.2 Operation Using Control Codes

In numerous positioning system applications, defined processes (= event) must be started at specific positions. This means that the exact positions must be defined via code tapes for positioning.

If an event needs to start at a particular position or a direction decision needs to be made, a control code is mounted parallel to the actual lane.

Only a specific event and the associated process then have to be programmed into the plant control system. The position in which the corresponding control code is placed next to the code tape for positioning does not have to be determined until the point of final commissioning of the plant. Even if subsequent changes are made to the layout of a plant, the relevant control code is simply moved to the new position without the need for program modifications.

Control codes are code tapes measuring one meter in length. The control code has an encrypted number. Control codes have numbers ranging from 001 to 999.

When the read head enters the range of a control code, it sets the control code flag in its output data.

The 1-meter-long control code can be shortened. However, the minimum length should be 3 codes (60 mm). If the speed of the read head increases, a longer control code is required. If the read head travels at maximum speed, a full-length control code of 1 meter must be positioned next to the code tape for positioning.

The minimum length of a control code can be calculated according to the following formula depending on the travel speed and trigger period:

$$L_{\text{control code}} = 60 \text{ mm} + V_{\text{max}} [\text{m/s}] * T_{\text{Trigger period}} [\text{s}] * 2$$

The trigger period is 40 ms.

### Example

#### Example calculation

The minimum length of the control code at a speed of 3 m/s and a trigger period of 40 ms is:

$$L_{\text{control code}} = 60 \text{ mm} + 3 \text{ m/s} * 40 \text{ ms} * 2 = \mathbf{300 \text{ mm}}$$

Control codes are identified by the printed number, in this case "Control 12".

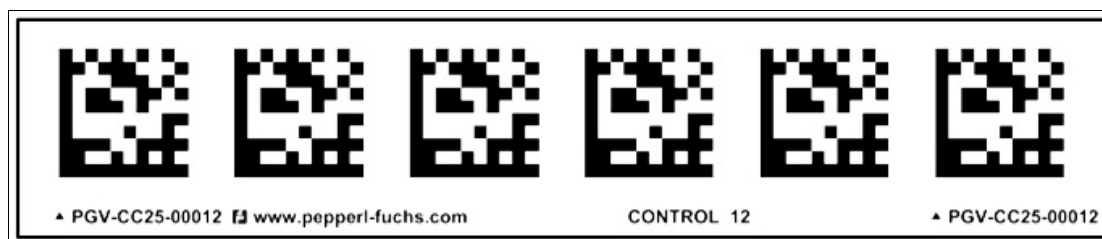

Figure 5.3 PGV-CC25-0012

The illustration shows part of control code #12

Refer to the "Accessories" chapter for ordering information relating to control codes.



### 5.3 Operation in case of repair

If repairs are required, the **Code Tape Generator** at [www.pepperl-fuchs.com](http://www.pepperl-fuchs.com) can be used as a short-term workaround. This generator enables segments of code tape to be produced and printed out online.

Enter the start value in meters and the code tape length of the section to be replaced in meters. This produces a printable PDF file containing the required segment of the code tape.

The printout must be used only as an emergency solution. The durability of the paper strip is extremely limited depending on the application!

## 6 Appendix

### 6.1 ASCII table

hex	dec	ASCII	hex	dec	ASCII	hex	dec	ASCII	hex	dec	ASCII
00	0	NUL	20	32	Space	40	64	@	60	96	'
01	1	SOH	21	33	!	41	65	A	61	97	a
02	2	STX	22	34	"	42	66	B	62	98	b
03	3	ETX	23	35	#	43	67	C	63	99	c
04	4	EOT	24	36	\$	44	68	D	64	100	d
05	5	ENQ	25	37	%	45	69	E	65	101	e
06	6	ACK	26	38	&	46	70	F	66	102	f
07	7	BEL	27	39	'	47	71	G	67	103	g
08	8	BS	28	40	(	48	72	H	68	104	h
09	9	HT	29	41	)	49	73	I	69	105	i
0A	10	LF	2A	42	*	4A	74	J	6A	106	j
0B	11	VT	2B	43	+	4B	75	K	6B	107	k
0C	12	FF	2C	44	,	4C	76	L	6C	108	l
0D	13	CR	2D	45	-	4D	77	M	6D	109	m
0E	14	SO	2E	46	.	4E	78	N	6E	110	n
0F	15	SI	2F	47	/	4F	79	O	6F	111	o
10	16	DLE	30	48	0	50	80	P	70	112	p
11	17	DC1	31	49	1	51	81	Q	71	113	q
12	18	DC2	32	50	2	52	82	R	72	114	r
13	19	DC3	33	51	3	53	83	S	73	115	s
14	20	DC4	34	52	4	54	84	T	74	116	t
15	21	NAK	35	53	5	55	85	U	75	117	u
16	22	SYN	36	54	6	56	86	V	76	118	v
17	23	ETB	37	55	7	57	87	W	77	119	w
18	24	CAN	38	56	8	58	88	X	78	120	x
19	25	EM	39	57	9	59	89	Y	79	121	y
1A	26	SUB	3A	58	:	5A	90	Z	7A	122	z
1B	27	ESC	3B	59	;	5B	91	[	7B	123	{
1C	28	FS	3C	60	<	5C	92	\	7C	124	
1D	29	GS	3D	61	=	5D	93	]	7D	125	}
1E	30	RS	3E	62	>	5E	94	^	7E	126	~
1F	31	US	3F	63	?	5F	95	_	7F	127	DEL

## 6.2 Code Cards with Special Functions

The following code cards have special functions:

- Activate
- User
- Fieldbus Store
- Fieldbus Cancel
- Fieldbus Use
- Fieldbus Default

### Activate

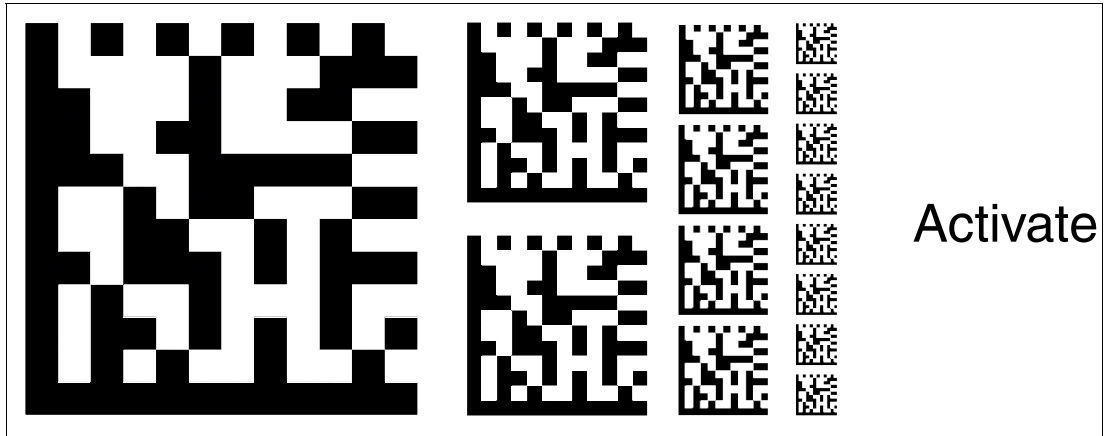

Figure 6.1 The "ACTIVATE" code card is used to activate external parameterization operating mode. To enter the parameterization operating mode the codecard "user" has to be read by the reading head.

### User

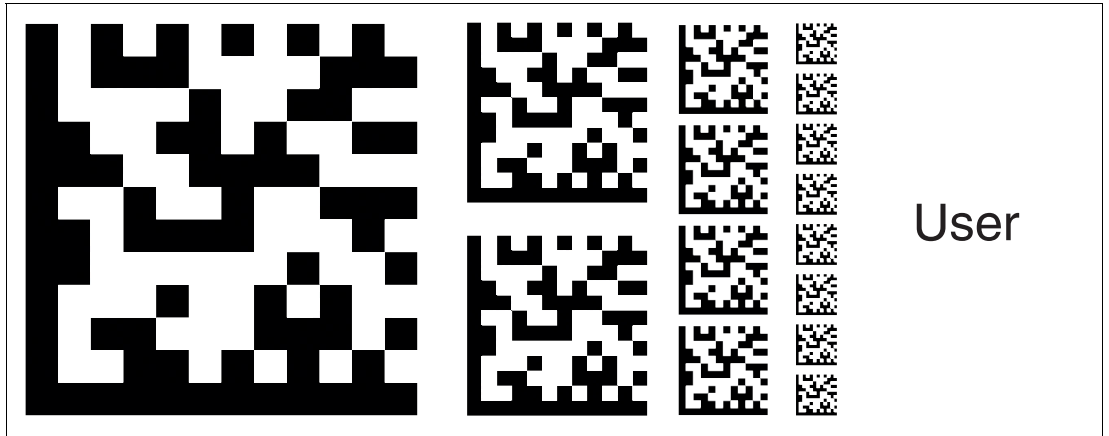

Figure 6.2 The "USER" code card is used to activate the user level in the external parameterization operating mode.

**Fieldbus Store**

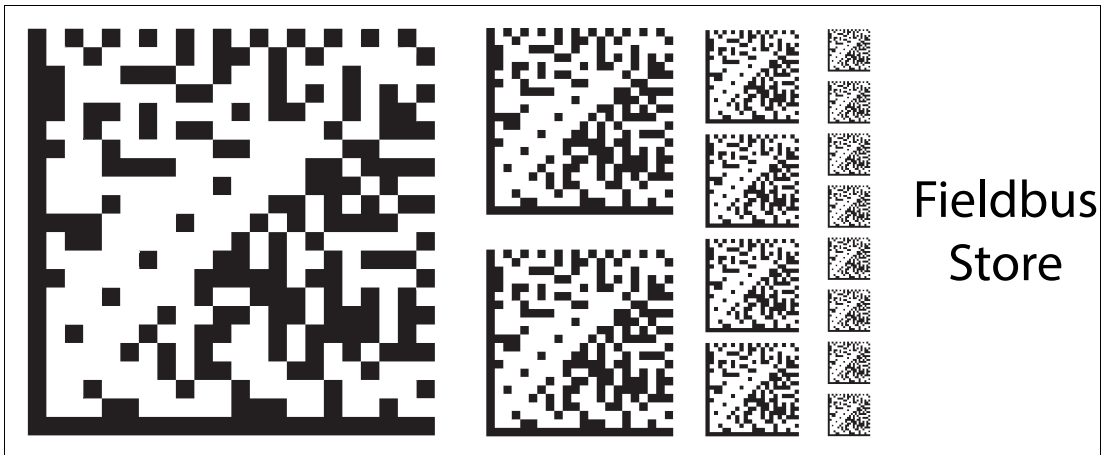

Figure 6.3 The code card "Fieldbus Store" stores the modified parameterization in the non-volatile memory of the reading head and terminates external parameterization operating mode.

**Fieldbus Cancel**

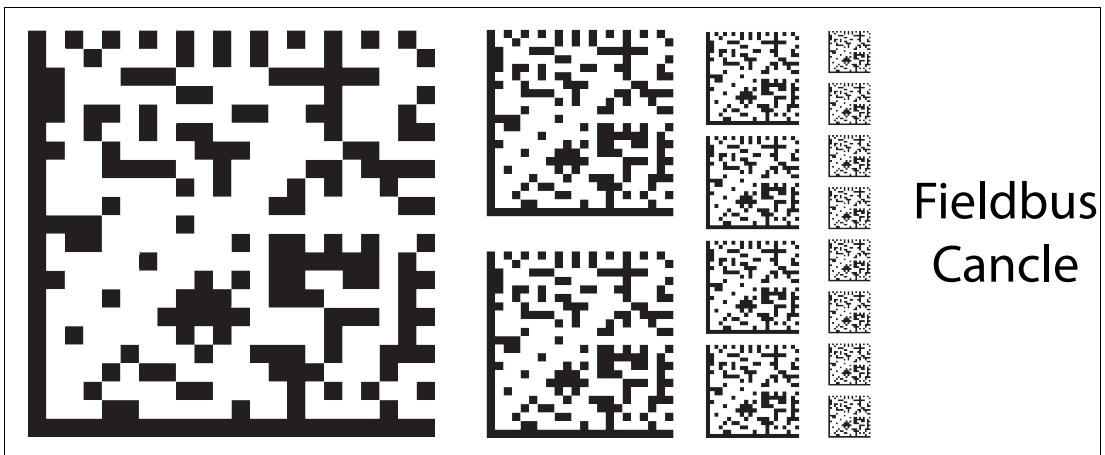

Figure 6.4 The code card "Fieldbus Cancel" discards the modified parameterization and terminates external parameterization operating mode. The reading head switches to normal mode and adopts the last valid configuration that was saved.

**Fieldbus Use**

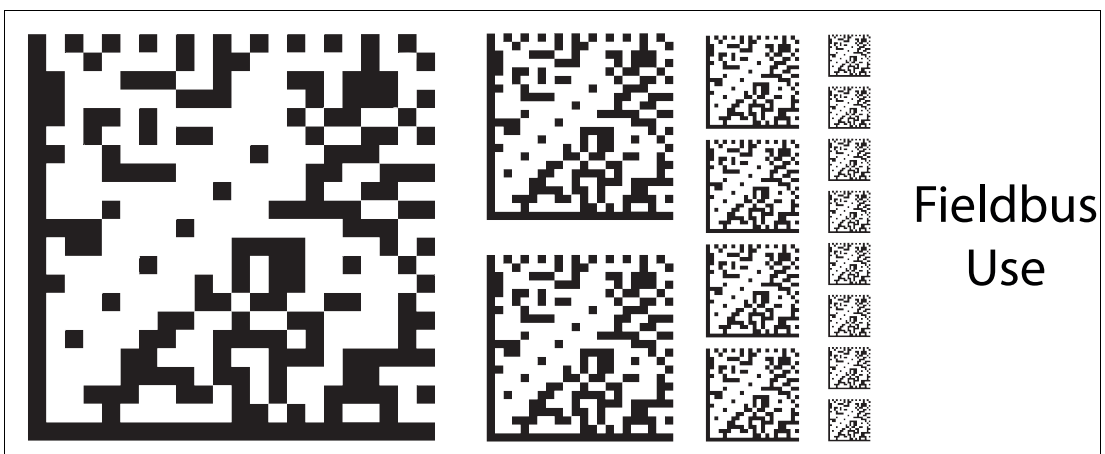

Figure 6.5 The code card "Fieldbus Use" adopts the modified configuration in the **volatile** working memory of the reading head and terminates external parameterization operating mode. The reading head then operates with this configuration. However, if the reading head is switched off and on again, the configuration is lost and the reading head operates with the last valid configuration that was saved. This function is used primarily for test purposes.

2023-07

Fieldbus Default

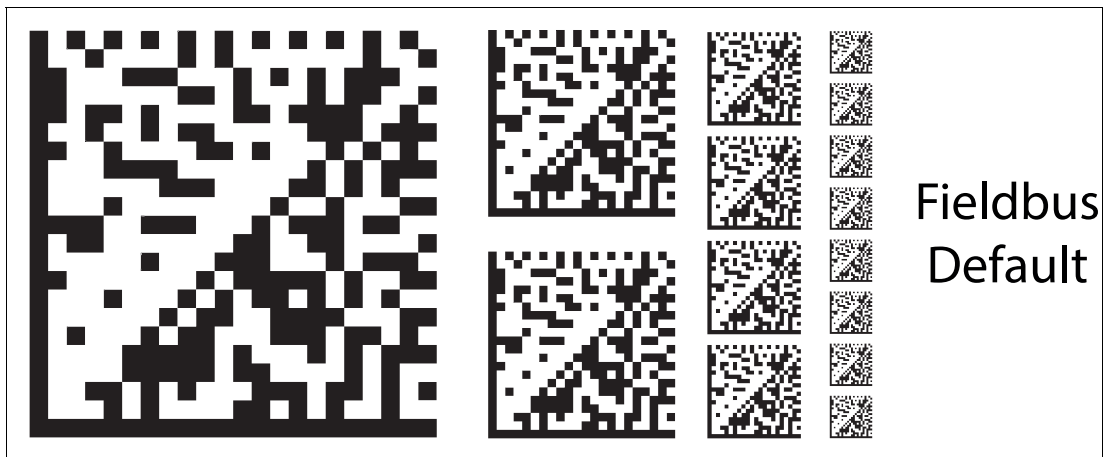

Figure 6.6 The code card "Fieldbus Default" restores the settings of the reading head to default and terminates external parameterization operating mode.

### 6.3 Code Cards for Setting the Baud Rate

Parameterization allows you to assign various transfer rates to the reader for communication via CANopen.

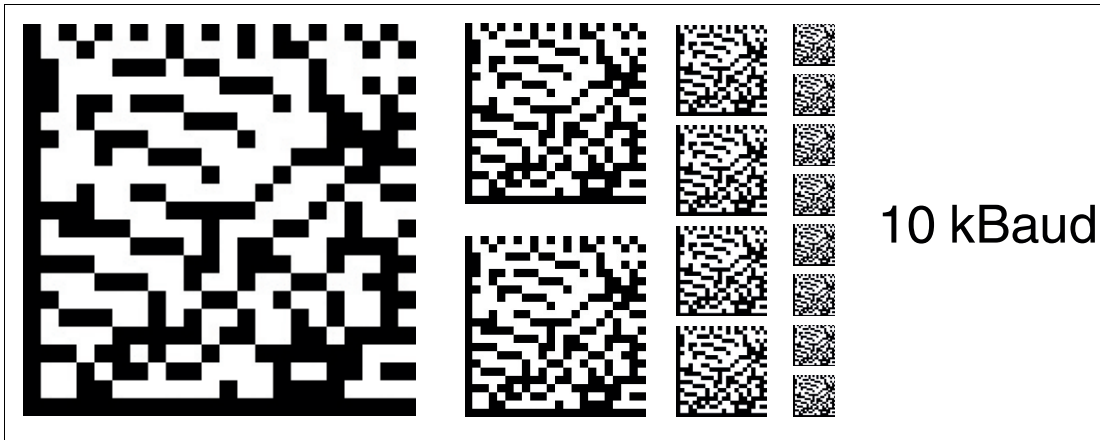

Figure 6.7 The code card assigns the 10 kBaud baud rate to the read head

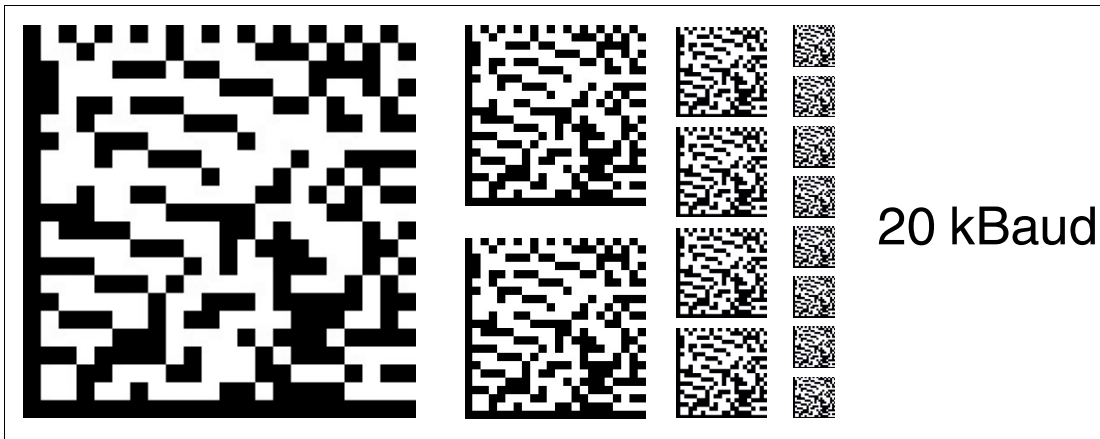

Figure 6.8 The code card assigns the 20 kBaud baud rate to the read head

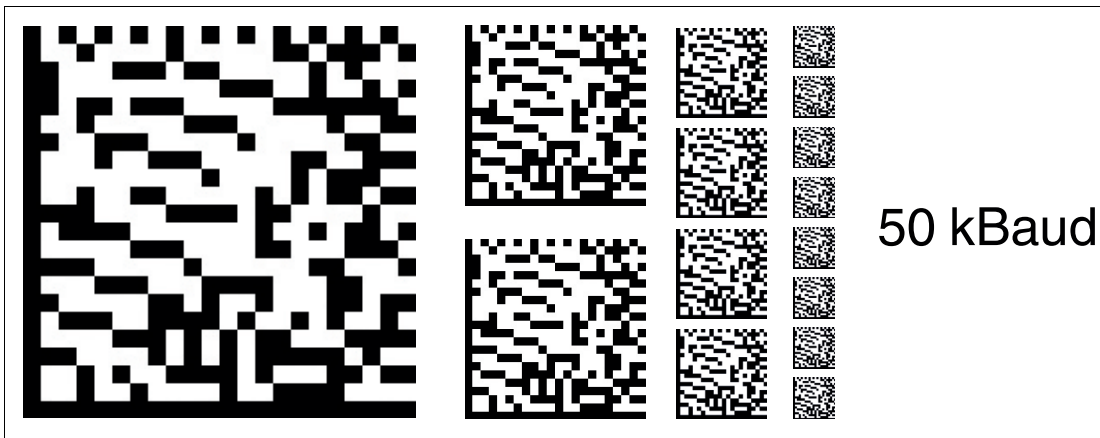

Figure 6.9 The code card assigns the 50 kBaud baud rate to the read head

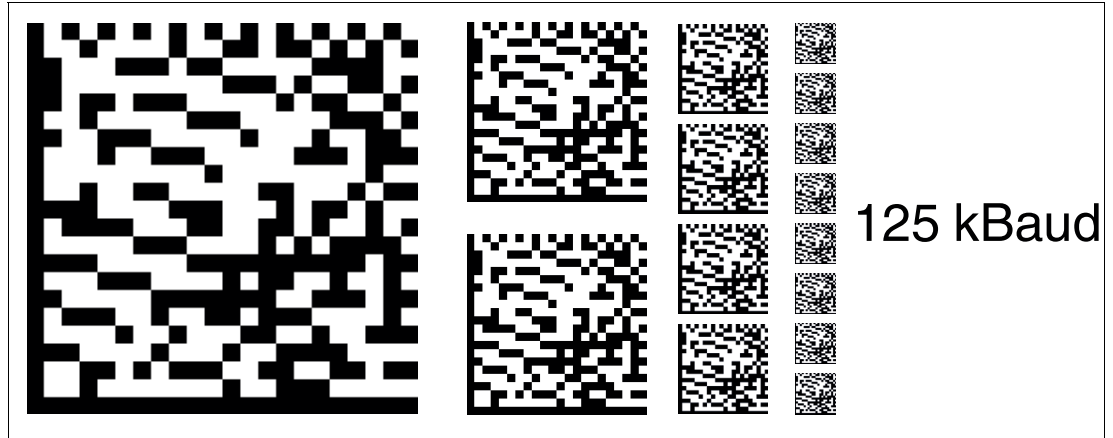

Figure 6.10 The code card assigns the 125 kBaud baud rate to the read head

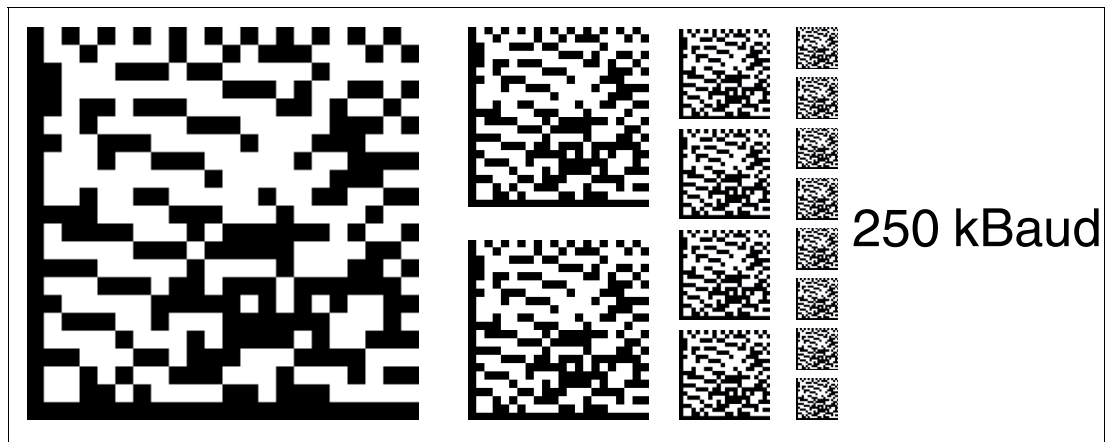

Figure 6.11 The code card assigns the 250 kBaud baud rate to the read head

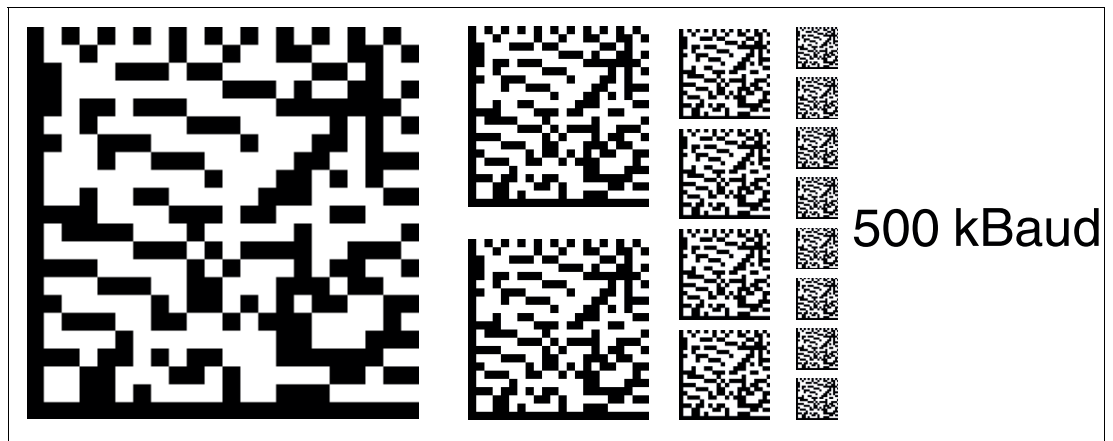

Figure 6.12 The code card assigns the 500 kBaud baud rate to the read head

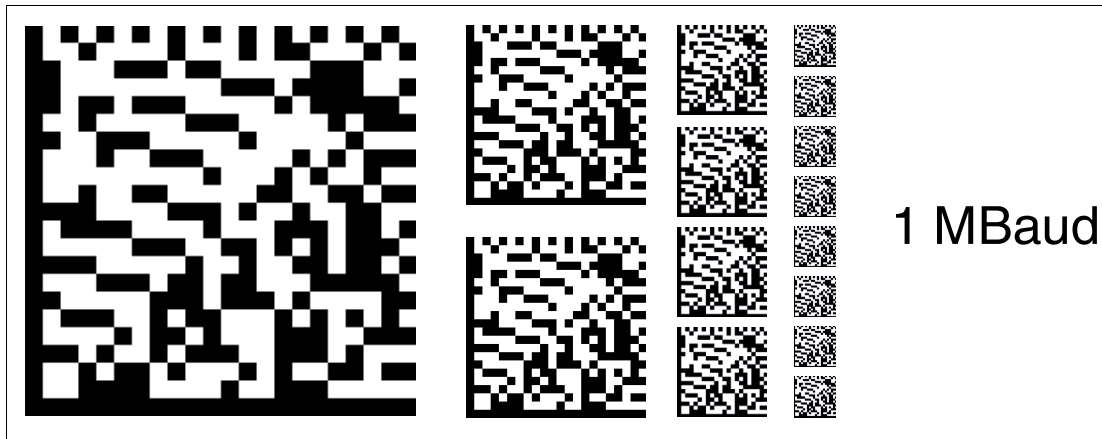

Figure 6.13 The code card assigns the 1 MBaud baud rate to the read head



## 6.4 Code Cards for Termination Resistor

Switches the termination resistor on or off and saves the settings.



### Note

To save the change to the termination resistor, the "Store Termination" code card must be used. The read head ends the parameterization mode.

The "Default" and "Cancel" code cards have no effect on changes to the termination resistor.

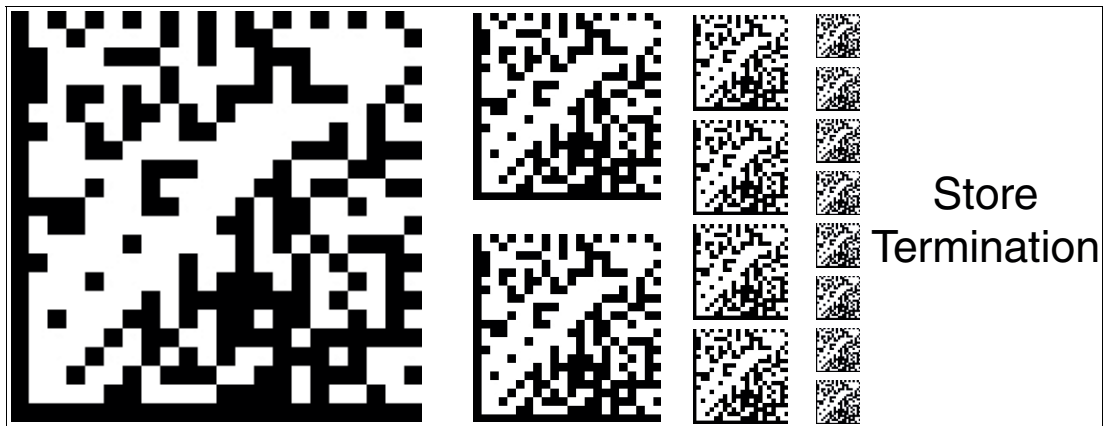

Figure 6.14 The "Store Termination" code card saves the changes made to the termination resistor and ends the parameterization mode.

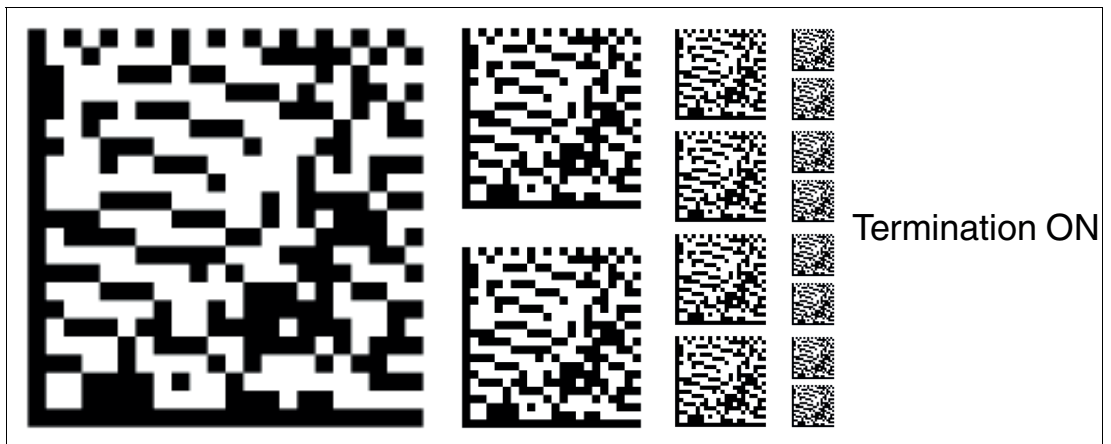

Figure 6.15 The Termination ON code card activates the termination resistor on the bus.

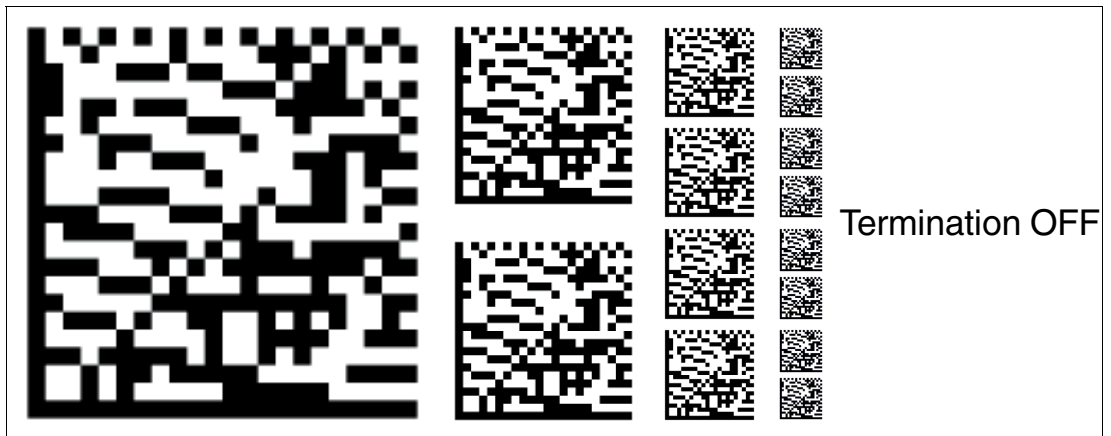

Figure 6.16 The Termination OFF code card deactivates the termination resistor on the bus.

## 6.5 Code cards to configure the fieldbus address

With the following code cards you can assign the fieldbus addresses 001 - 125.

### Fieldbus address 001

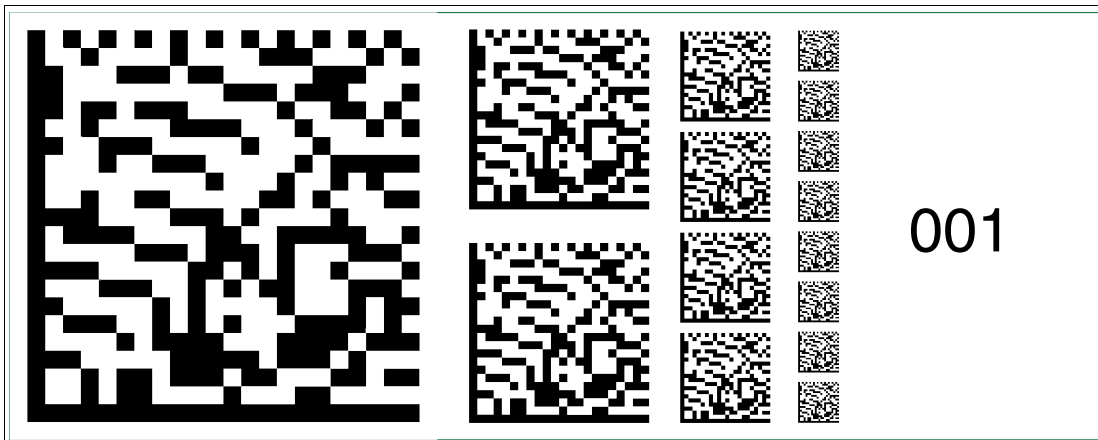

Figure 6.17 The code card "Fieldbus address 001" assigns the fieldbus address 001 to the device.

### Fieldbus address 002

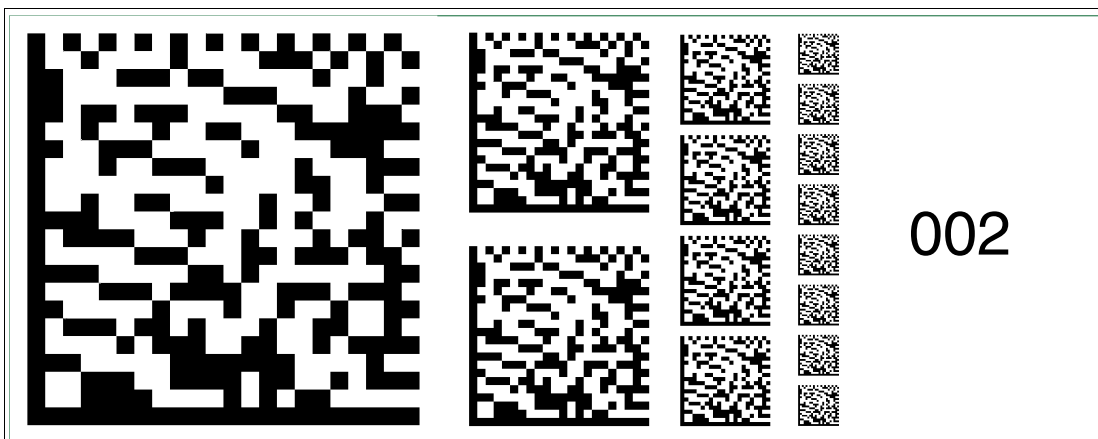

Figure 6.18 The code card "Fieldbus address 002" assigns the fieldbus address 002 to the device.

**Fieldbus address 003**

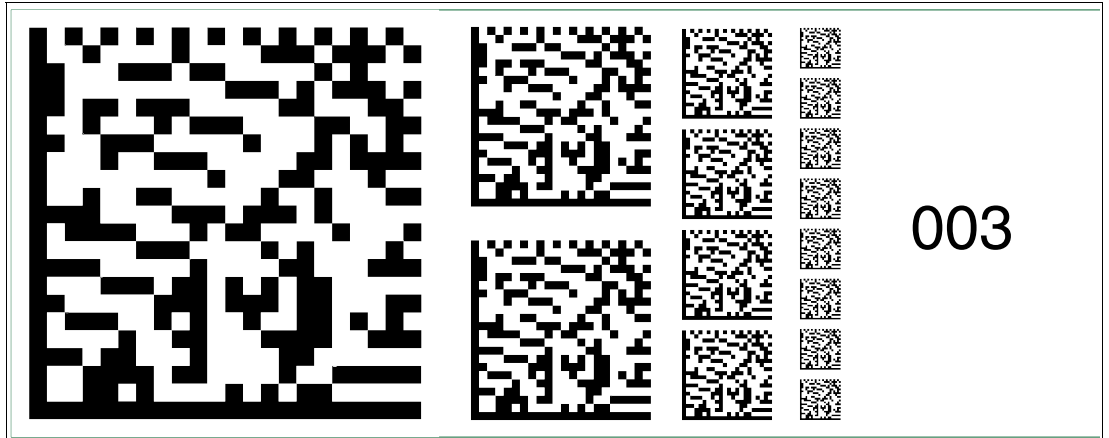

Figure 6.19 The code card "Fieldbus address 003" assigns the fieldbus address 003 to the device.

**Fieldbus address 004**

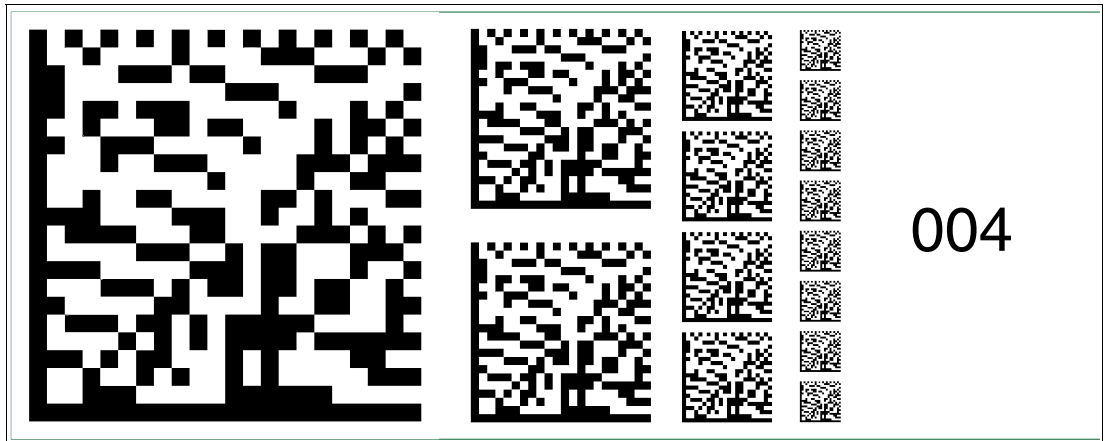

Figure 6.20 The code card "Fieldbus address 004" assigns the fieldbus address 004 to the device.

**Fieldbus address 005**

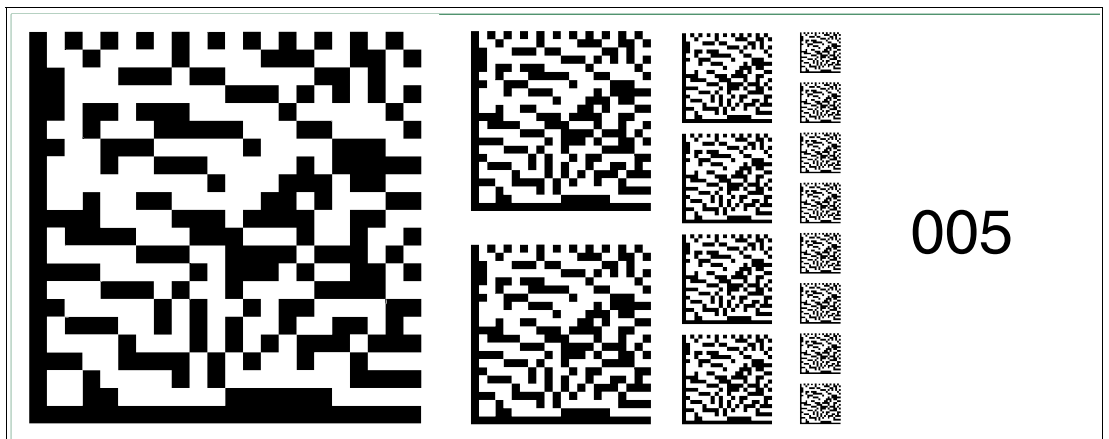

Figure 6.21 The code card "Fieldbus address 005" assigns the fieldbus address 005 to the device.

**Fieldbus address 006**

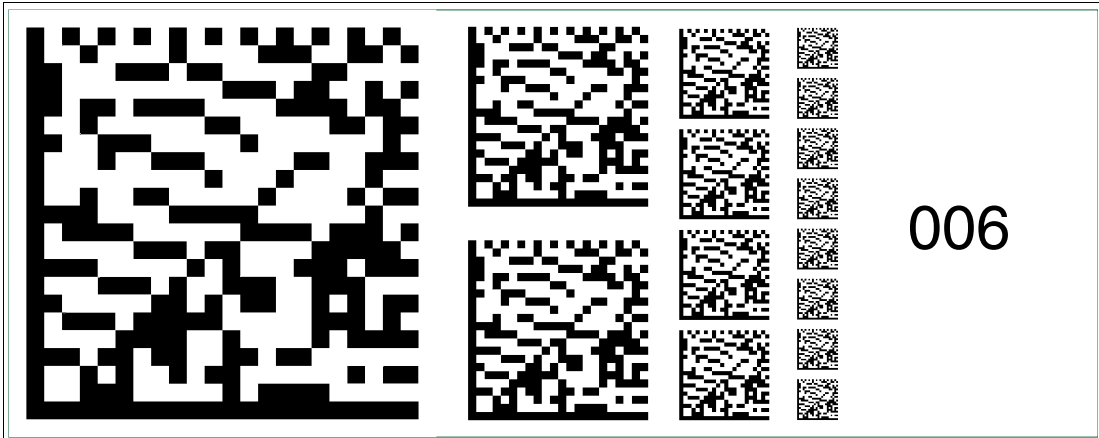

Figure 6.22 The code card "Fieldbus address 006" assigns the fieldbus address 006 to the device.

**Fieldbus address 007**

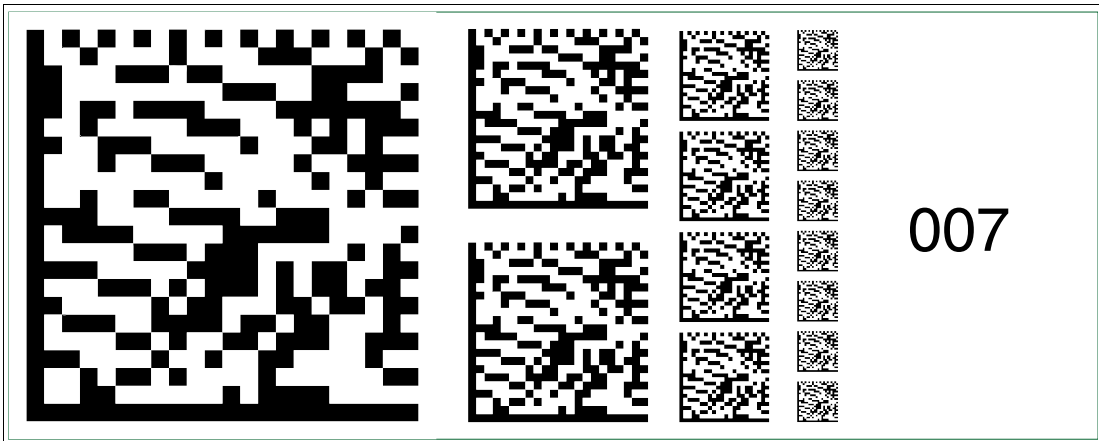

Figure 6.23 The code card "Fieldbus address 007" assigns the fieldbus address 007 to the device.

**Fieldbus address 008**

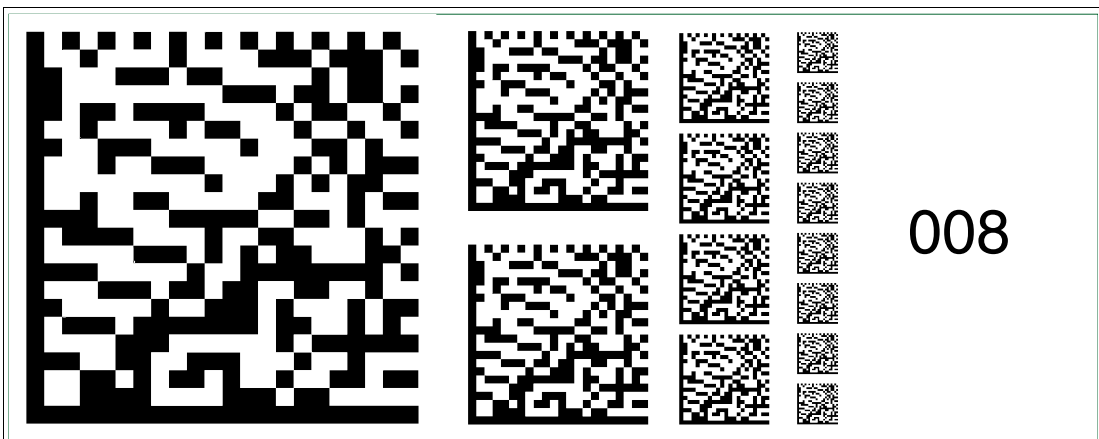

Figure 6.24 The code card "Fieldbus address 008" assigns the fieldbus address 008 to the device.

**Fieldbus address 009**

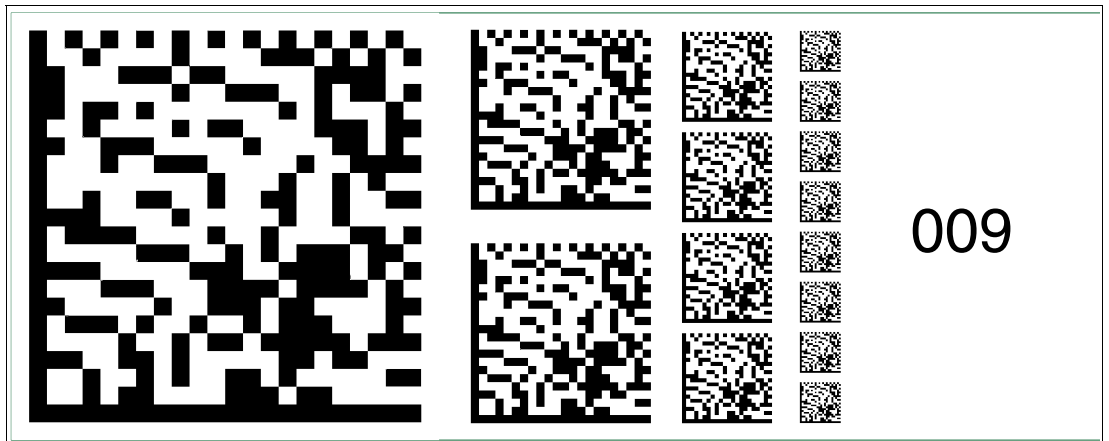

Figure 6.25 The code card "Fieldbus address 009" assigns the fieldbus address 009 to the device.

**Fieldbus address 010**

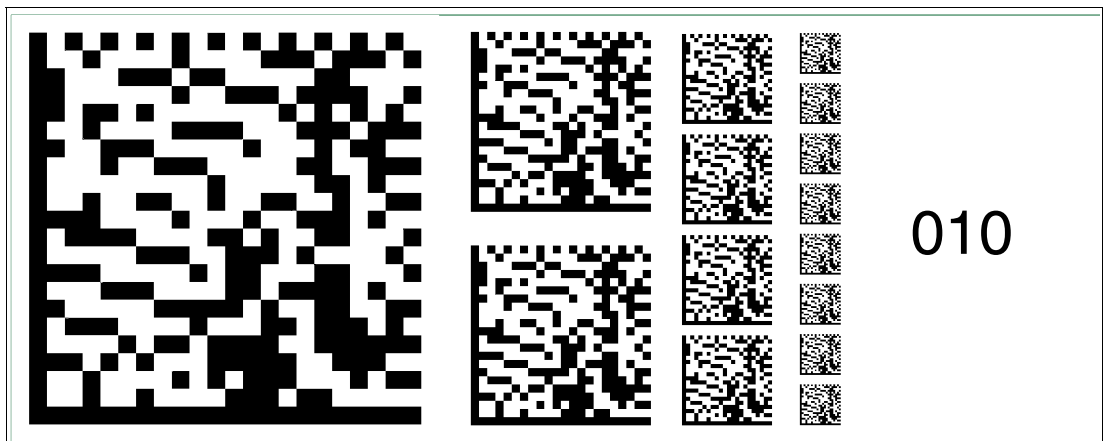

Figure 6.26 The code card "Fieldbus address 010" assigns the fieldbus address 010 to the device.

**Fieldbus address 011**

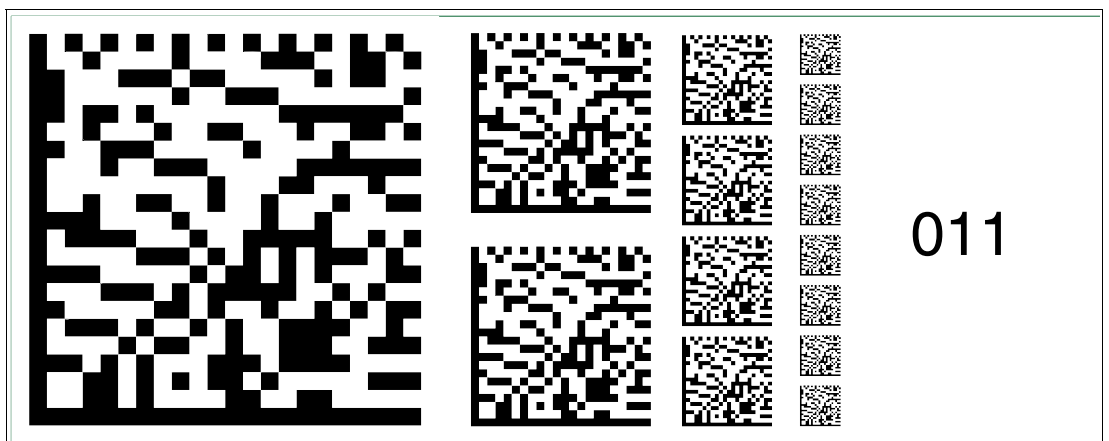

Figure 6.27 The code card "Fieldbus address 011" assigns the fieldbus address 011 to the device.

**Fieldbus address 012**

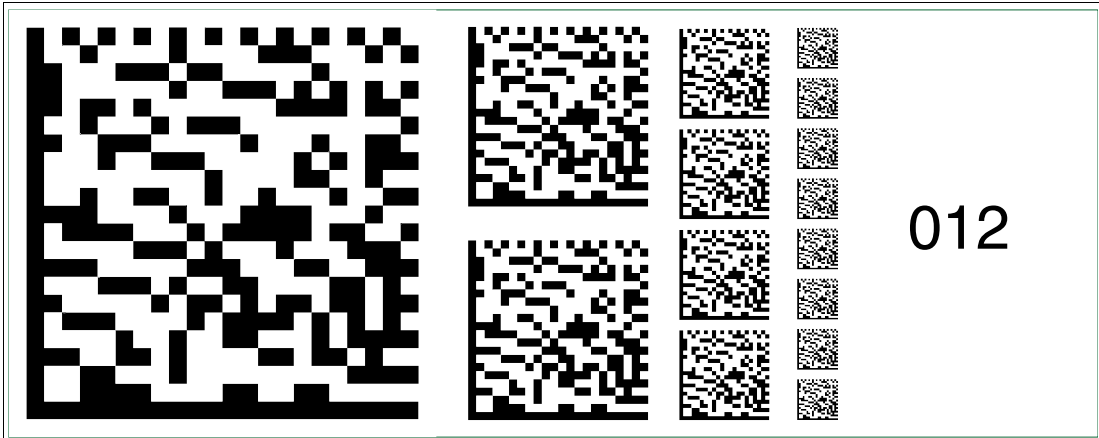

Figure 6.28 The code card "Fieldbus address 012" assigns the fieldbus address 012 to the device.

**Fieldbus address 013**

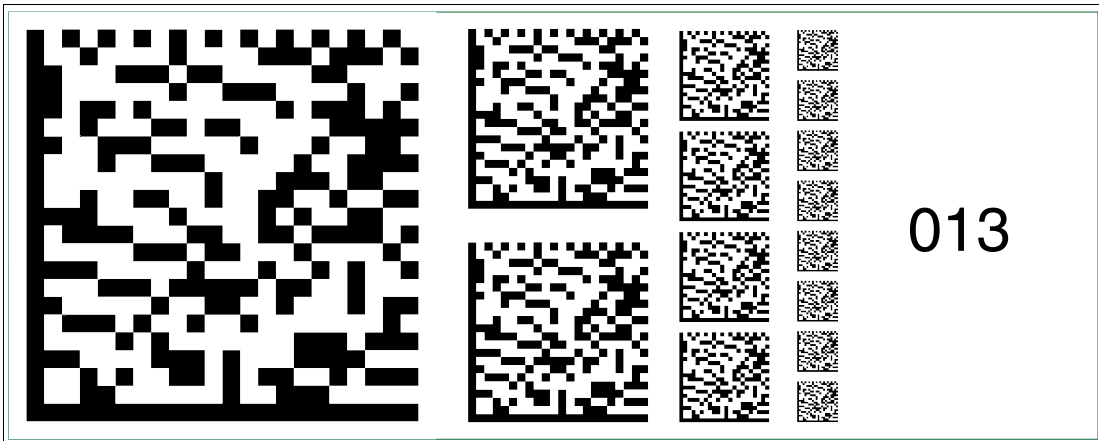

Figure 6.29 The code card "Fieldbus address 013" assigns the fieldbus address 013 to the device.

**Fieldbus address 014**



Figure 6.30 The code card "Fieldbus address 014" assigns the fieldbus address 014 to the device.

**Fieldbus address 015**

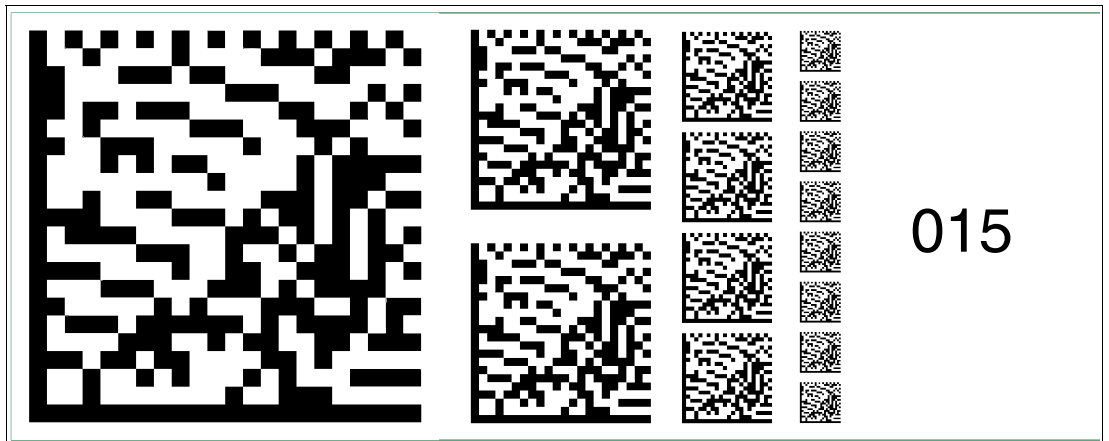

Figure 6.31 The code card "Fieldbus address 015" assigns the fieldbus address 015 to the device.

**Fieldbus address 016**

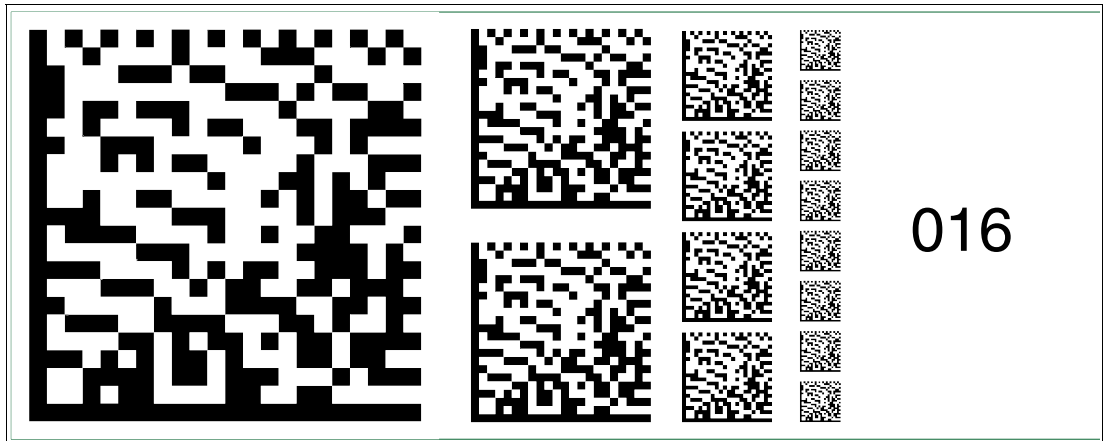

Figure 6.32 The code card "Fieldbus address 016" assigns the fieldbus address 016 to the device.

**Fieldbus address 017**

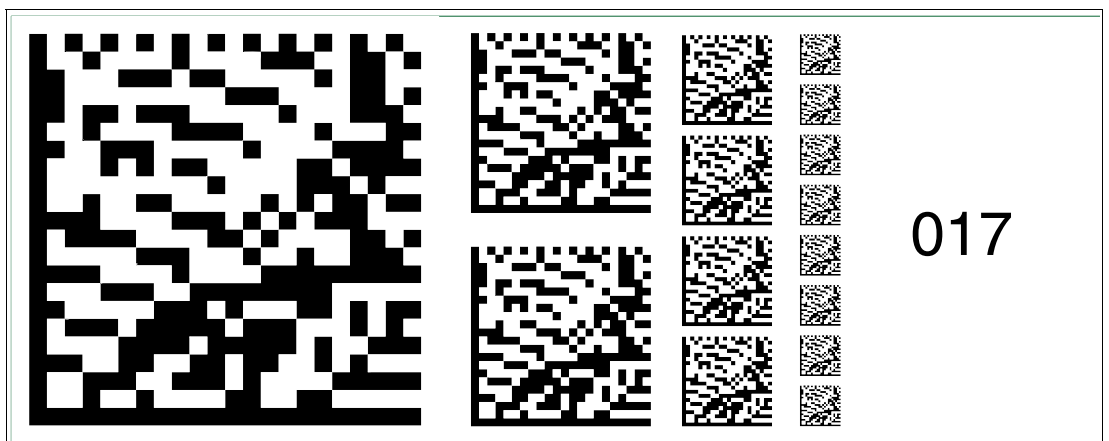

Figure 6.33 The code card "Fieldbus address 017" assigns the fieldbus address 017 to the device.

**Fieldbus address 018**

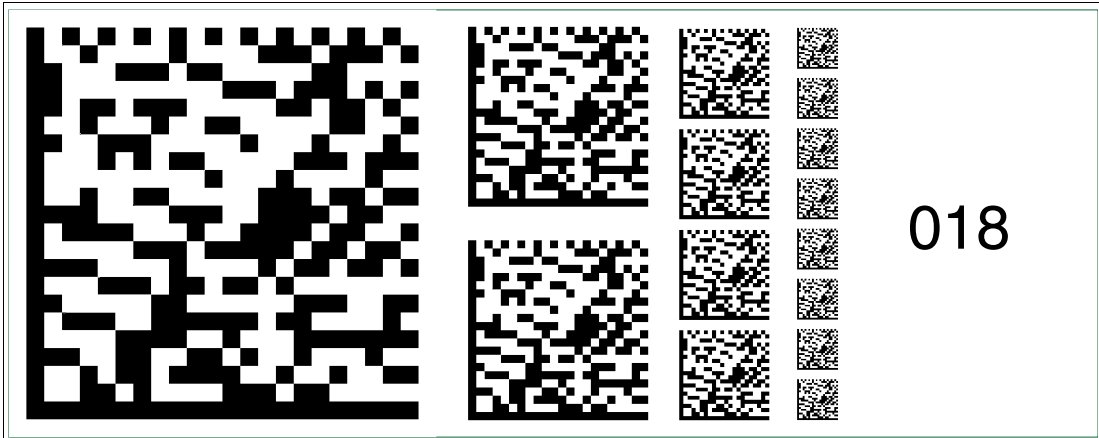

Figure 6.34 The code card "Fieldbus address 018" assigns the fieldbus address 018 to the device.

**Fieldbus address 019**

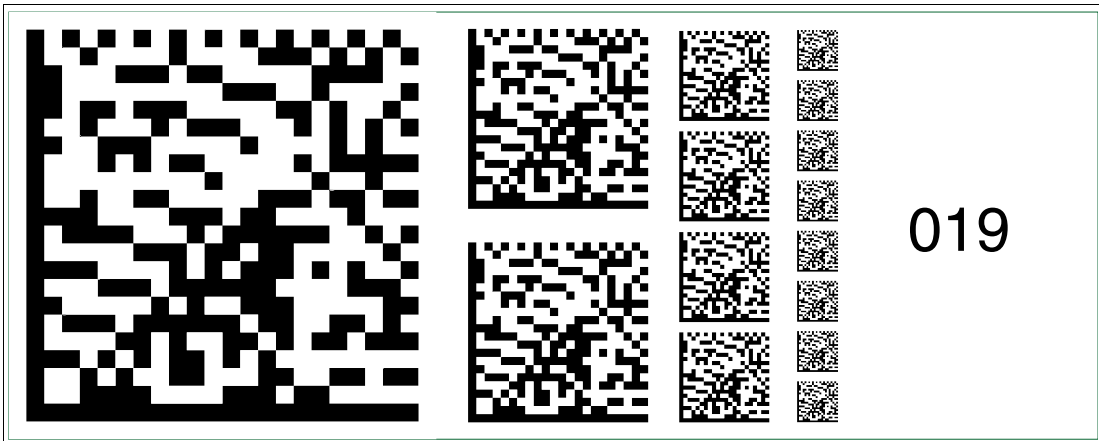

Figure 6.35 The code card "Fieldbus address 019" assigns the fieldbus address 019 to the device.

**Fieldbus address 020**

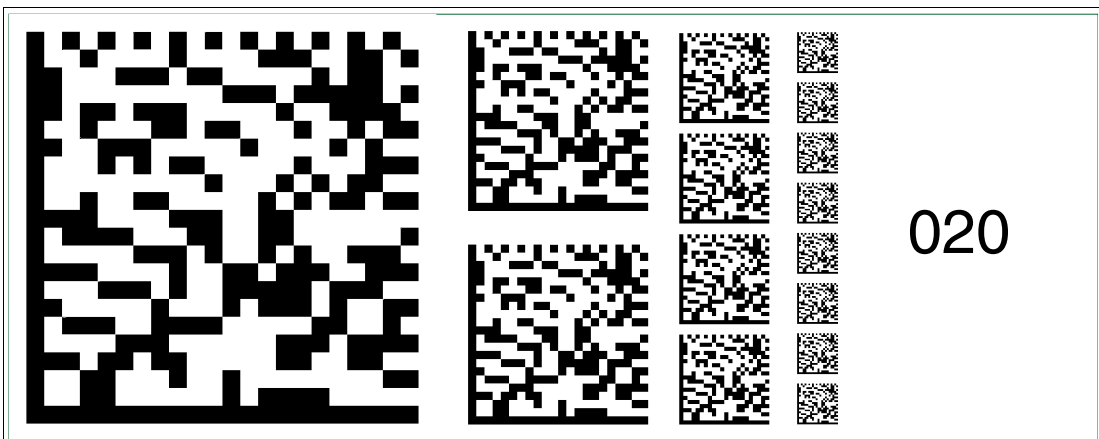

Figure 6.36 The code card "Fieldbus address 020" assigns the fieldbus address 020 to the device.



**Fieldbus address 021**

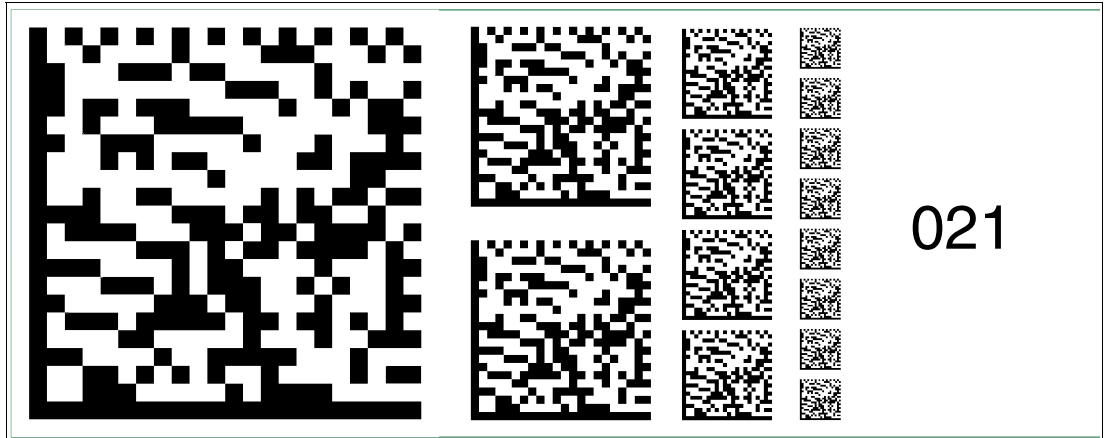

Figure 6.37 The code card "Fieldbus address 021" assigns the fieldbus address 021 to the device.

**Fieldbus address 022**

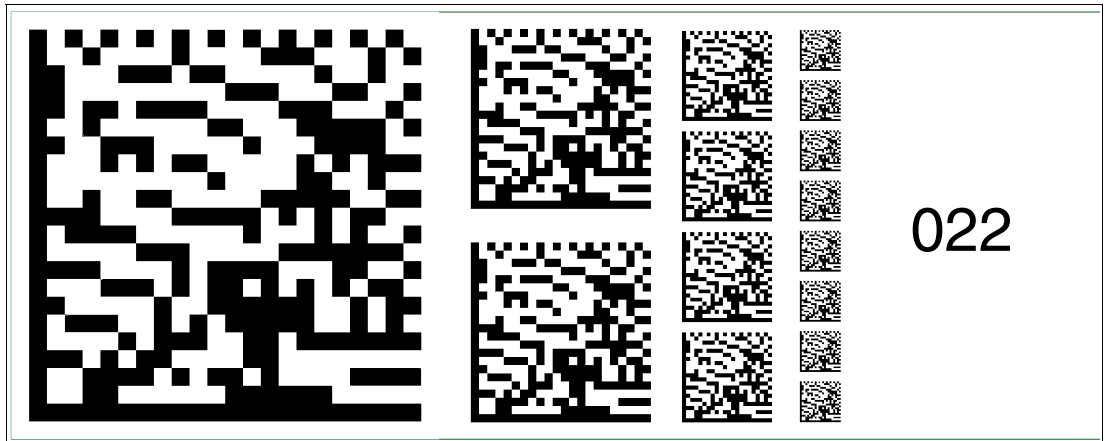

Figure 6.38 The code card "Fieldbus address 022" assigns the fieldbus address 022 to the device.

**Fieldbus address 023**

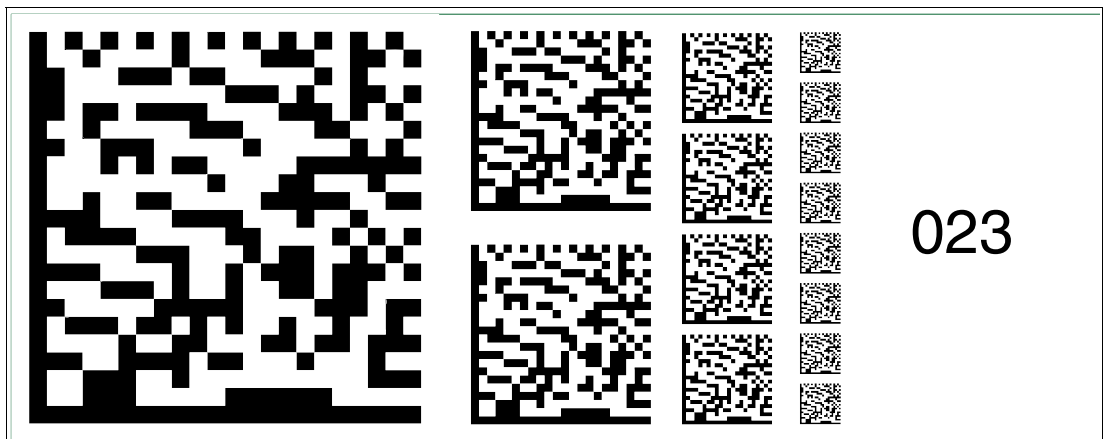

Figure 6.39 The code card "Fieldbus address 023" assigns the fieldbus address 023 to the device.

**Fieldbus address 024**

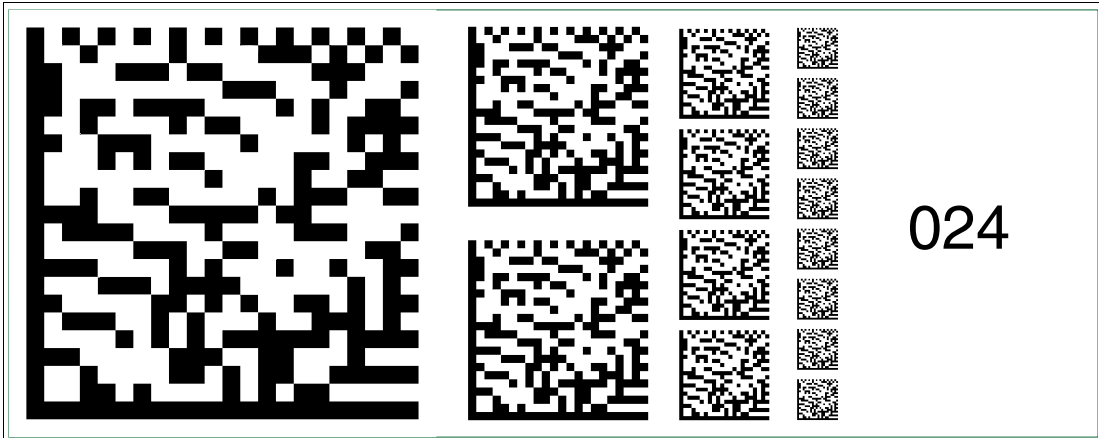

Figure 6.40 The code card "Fieldbus address 024" assigns the fieldbus address 024 to the device.

**Fieldbus address 025**

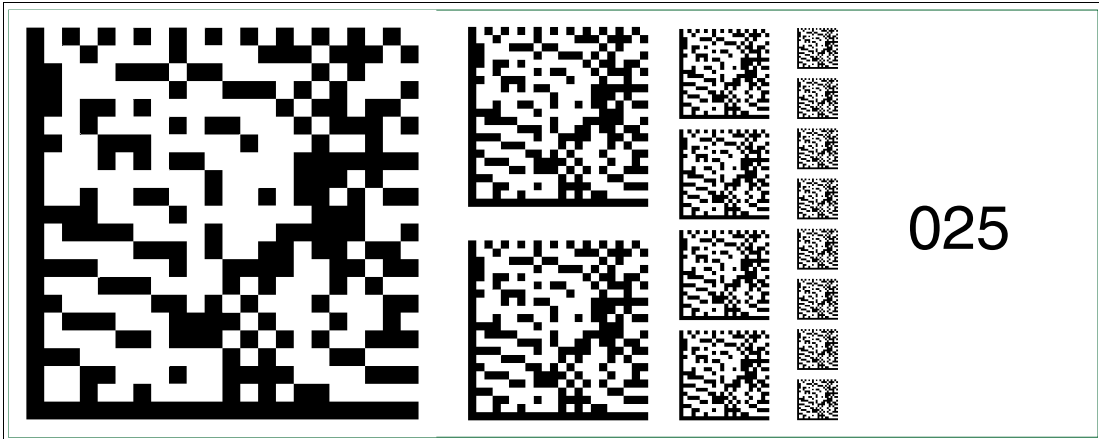

Figure 6.41 The code card "Fieldbus address 025" assigns the fieldbus address 025 to the device.

**Fieldbus address 026**

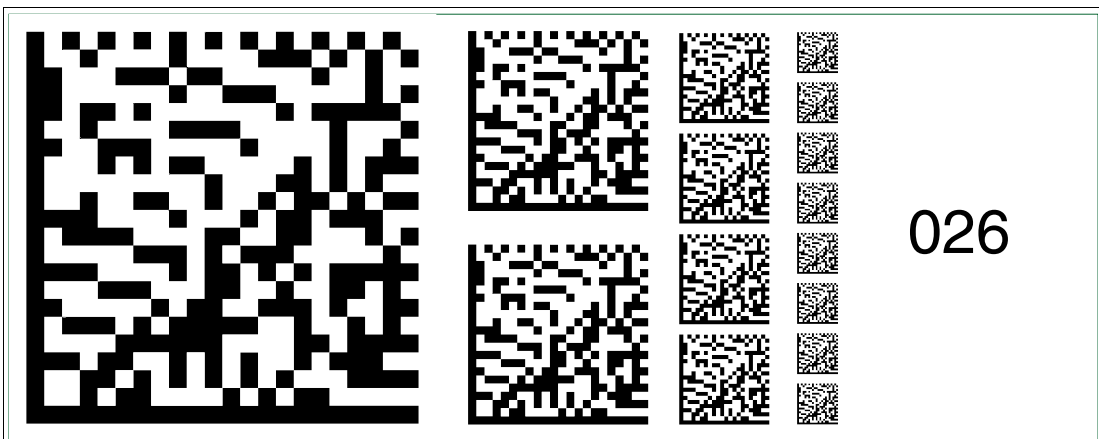

Figure 6.42 The code card "Fieldbus address 026" assigns the fieldbus address 026 to the device.

**Fieldbus address 027**

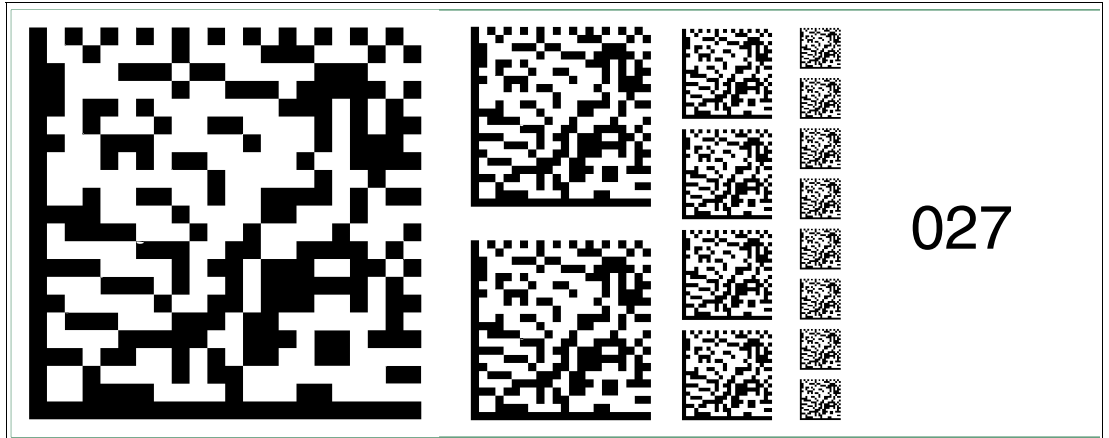

Figure 6.43 The code card "Fieldbus address 027" assigns the fieldbus address 027 to the device.

**Fieldbus address 028**

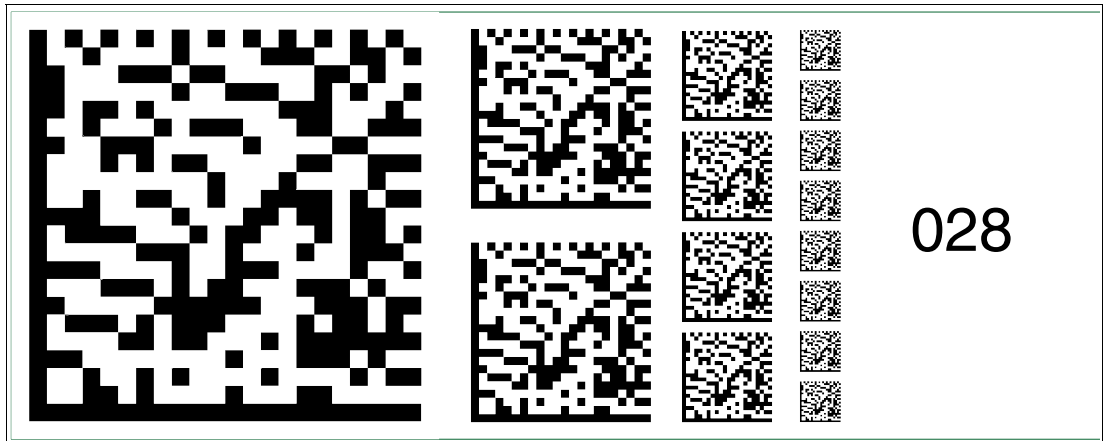

Figure 6.44 The code card "Fieldbus address 028" assigns the fieldbus address 028 to the device.

**Fieldbus address 029**

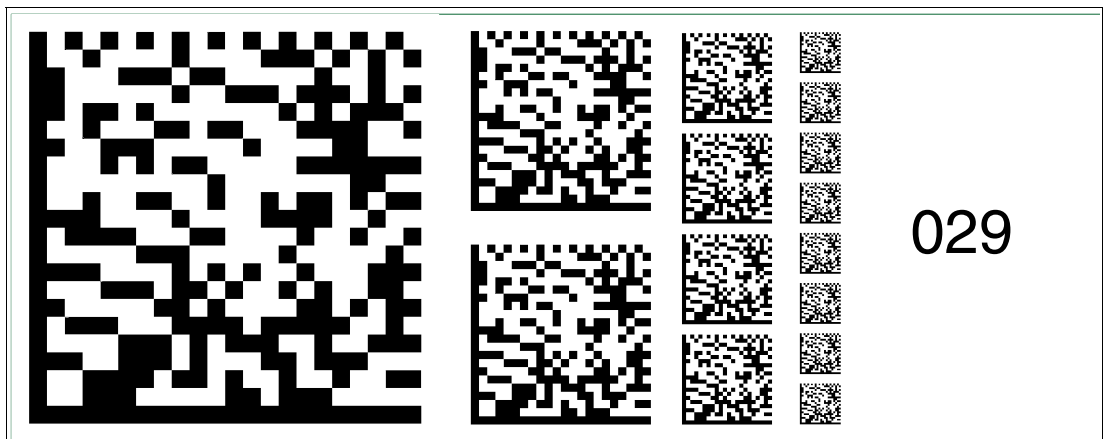

Figure 6.45 The code card "Fieldbus address 029" assigns the fieldbus address 029 to the device.

**Fieldbus address 030**

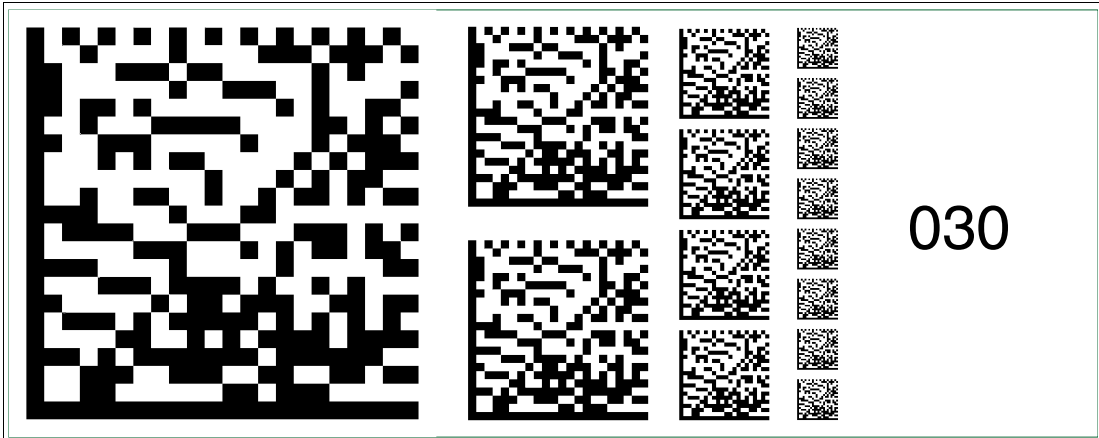

Figure 6.46 The code card "Fieldbus address 030" assigns the fieldbus address 030 to the device.

**Fieldbus address 031**

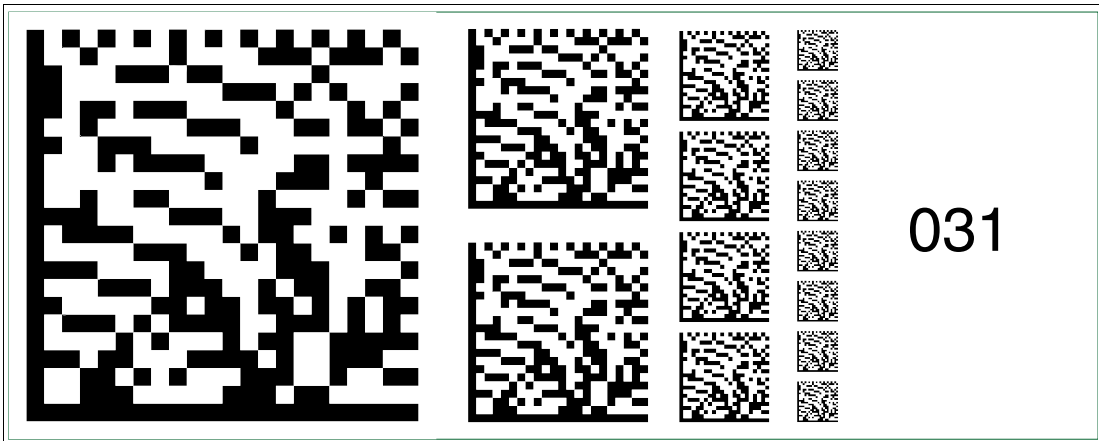

Figure 6.47 The code card "Fieldbus address 031" assigns the fieldbus address 031 to the device.

**Fieldbus address 032**



Figure 6.48 The code card "Fieldbus address 032" assigns the fieldbus address 032 to the device.

**Fieldbus address 033**

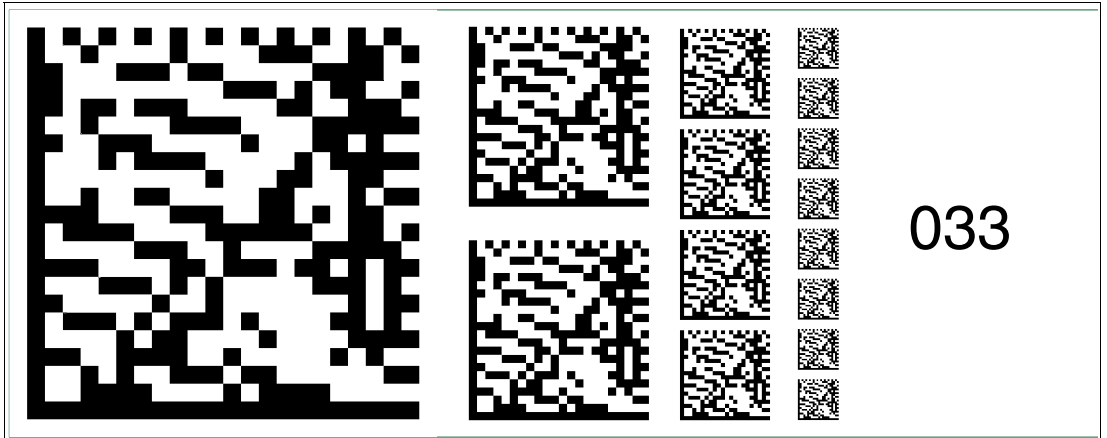

Figure 6.49 The code card "Fieldbus address 033" assigns the fieldbus address 033 to the device.

**Fieldbus address 034**

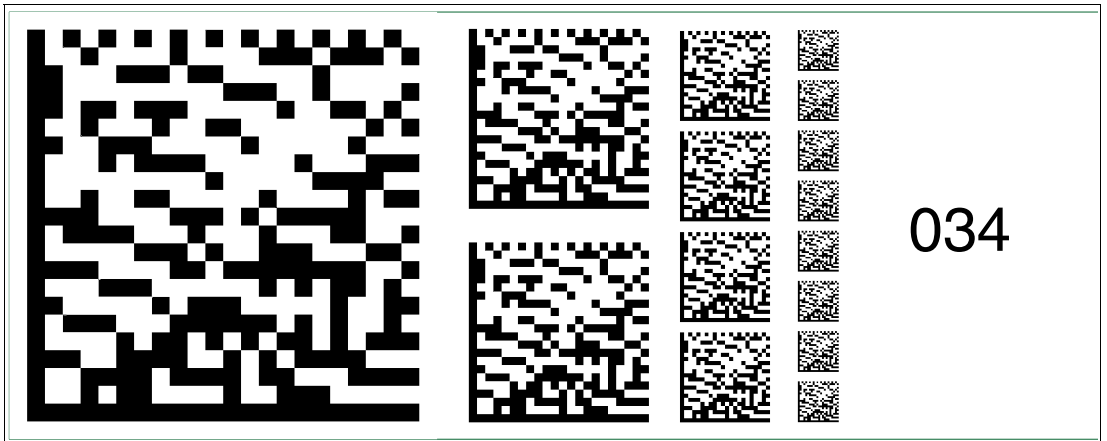

Figure 6.50 The code card "Fieldbus address 034" assigns the fieldbus address 034 to the device.

**Fieldbus address 035**

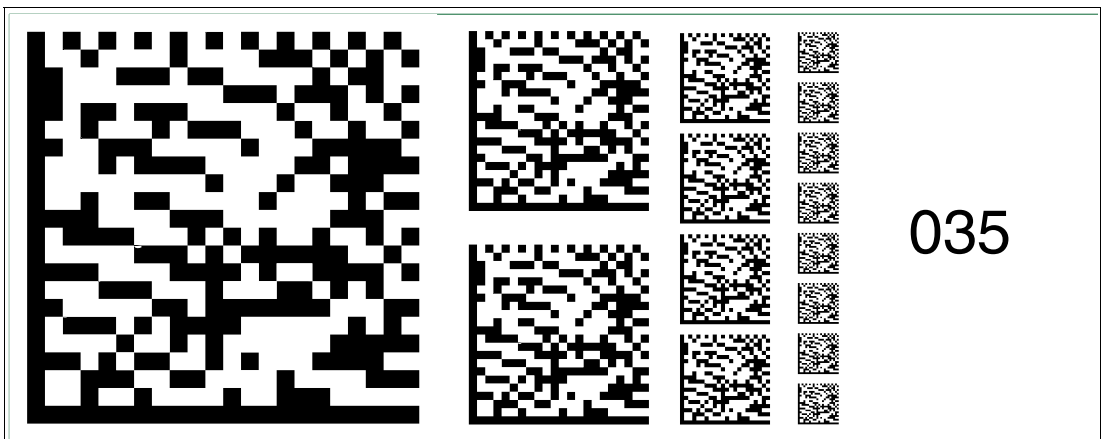

Figure 6.51 The code card "Fieldbus address 035" assigns the fieldbus address 035 to the device.

**Fieldbus address 036**

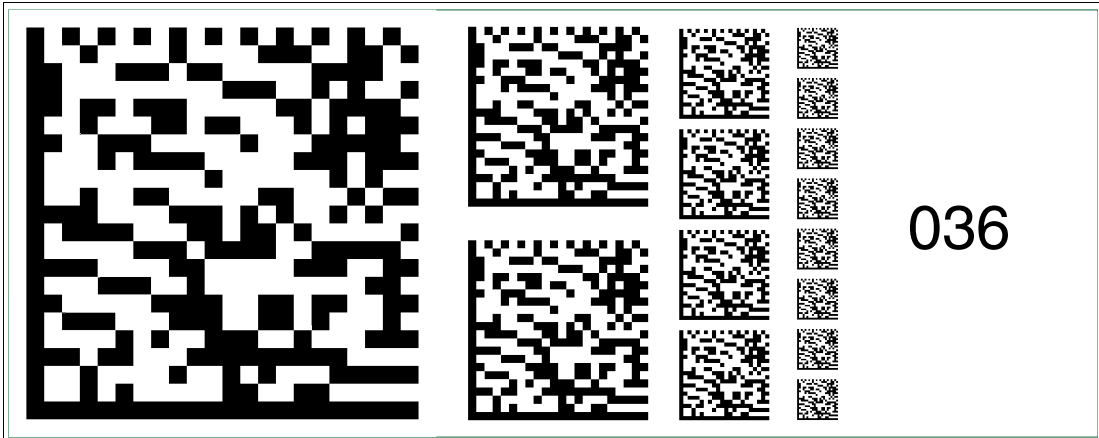

Figure 6.52 The code card "Fieldbus address 036" assigns the fieldbus address 036 to the device.

**Fieldbus address 037**

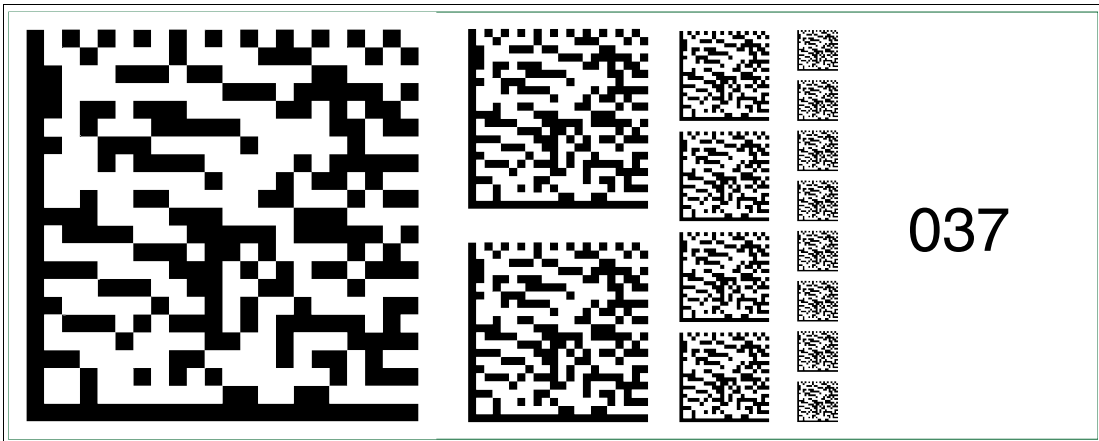

Figure 6.53 The code card "Fieldbus address 037" assigns the fieldbus address 037 to the device.

**Fieldbus address 038**



Figure 6.54 The code card "Fieldbus address 038" assigns the fieldbus address 038 to the device.

**Fieldbus address 039**

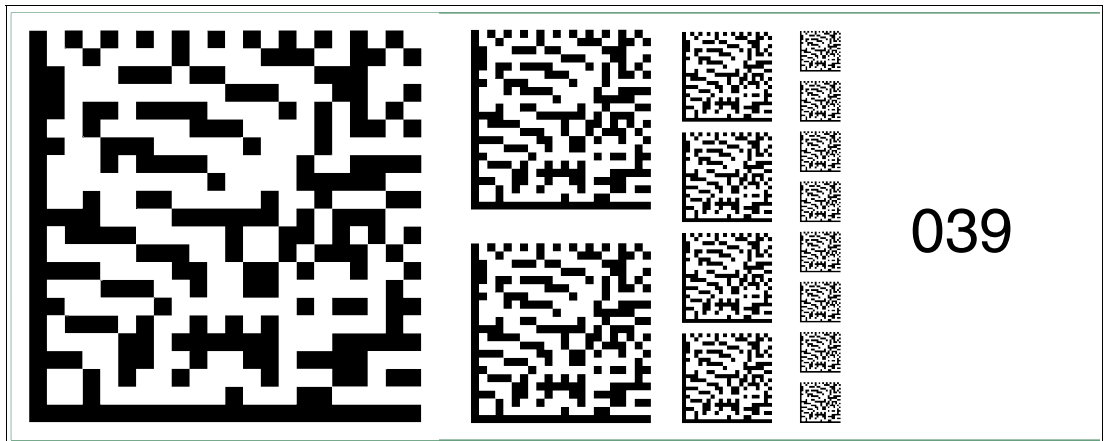

Figure 6.55 The code card "Fieldbus address 039" assigns the fieldbus address 039 to the device.

**Fieldbus address 040**

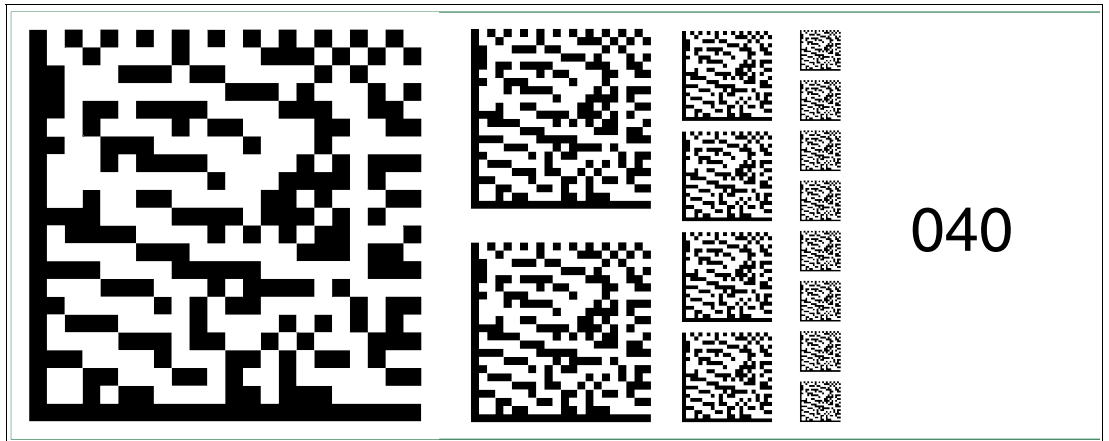

Figure 6.56 The code card "Fieldbus address 040" assigns the fieldbus address 040 to the device.

**Fieldbus address 041**

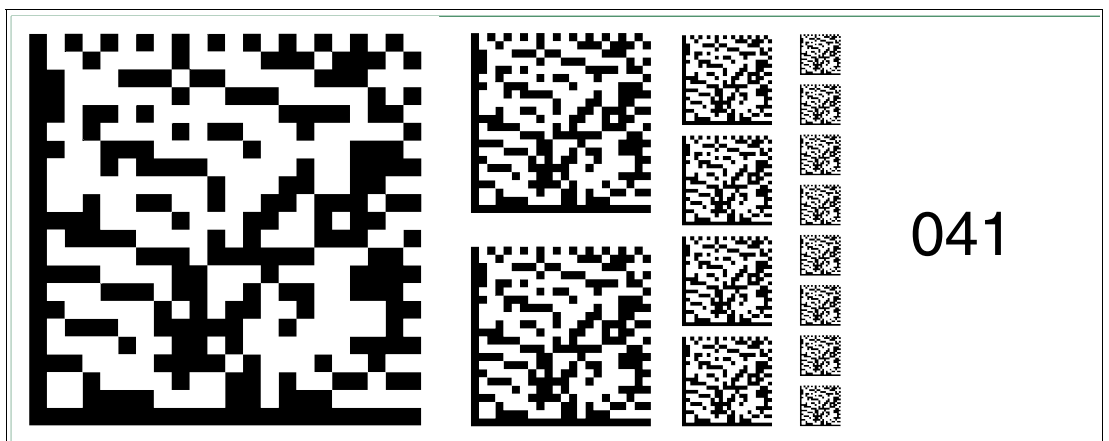

Figure 6.57 The code card "Fieldbus address 041" assigns the fieldbus address 041 to the device.

**Fieldbus address 042**

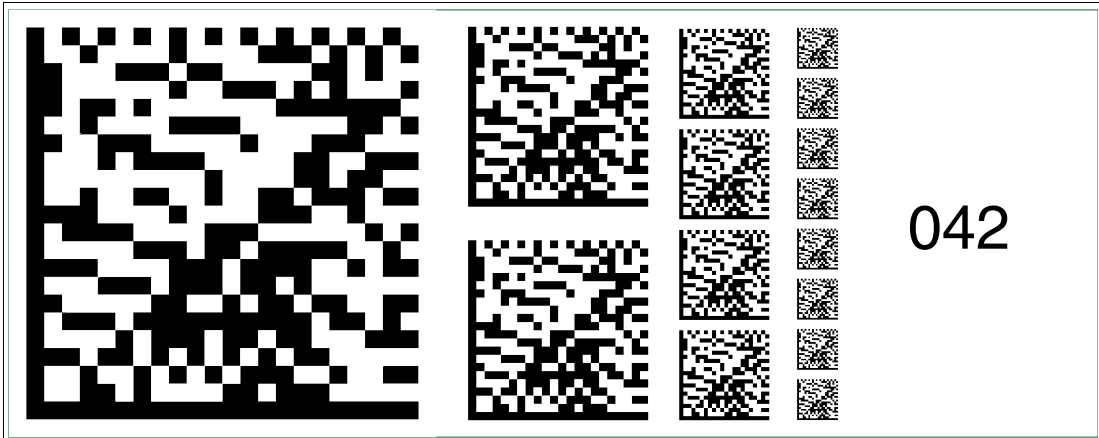

Figure 6.58 The code card "Fieldbus address 042" assigns the fieldbus address 042 to the device.

**Fieldbus address 043**

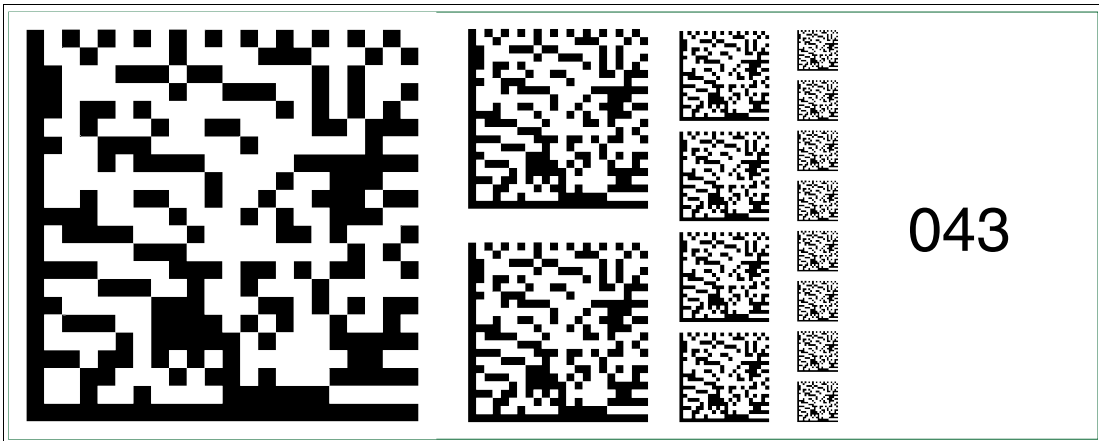

Figure 6.59 The code card "Fieldbus address 043" assigns the fieldbus address 043 to the device.

**Fieldbus address 044**

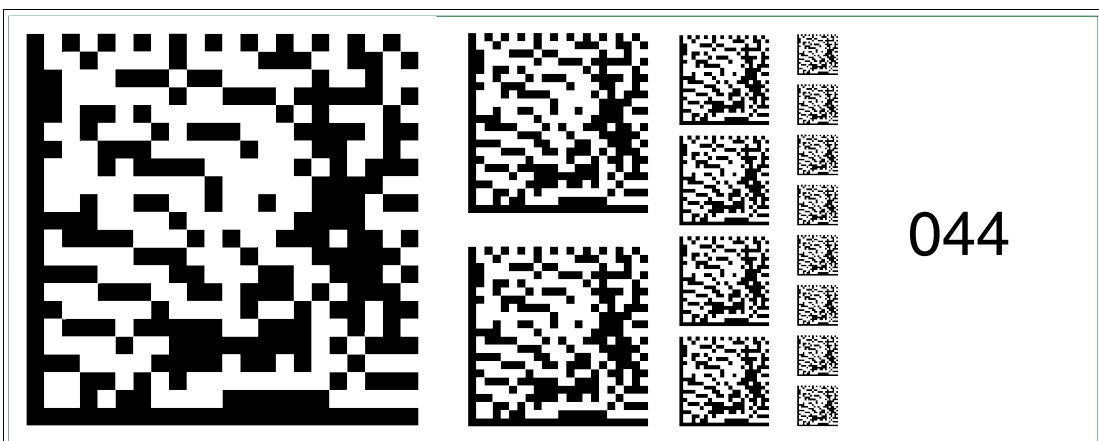

Figure 6.60 The code card "Fieldbus address 044" assigns the fieldbus address 044 to the device.



**Fieldbus address 045**

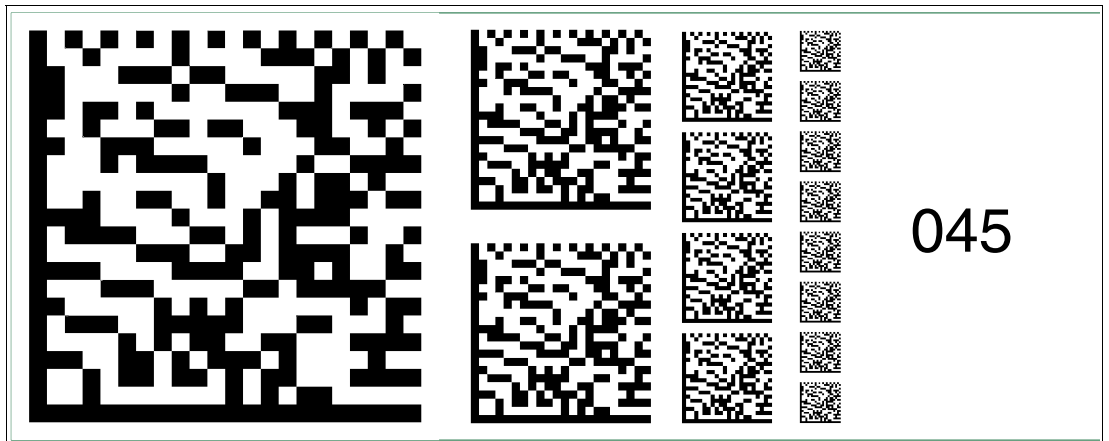

Figure 6.61 The code card "Fieldbus address 045" assigns the fieldbus address 045 to the device.

**Fieldbus address 046**

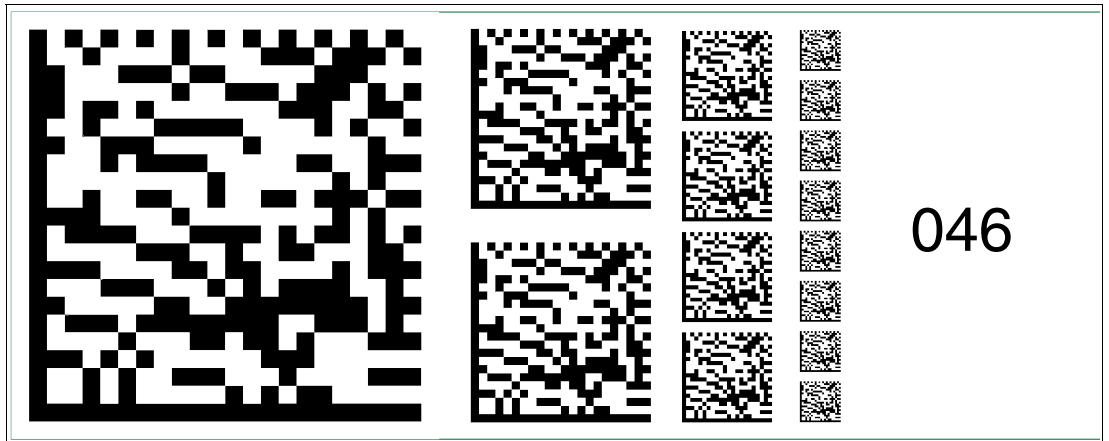

Figure 6.62 The code card "Fieldbus address 046" assigns the fieldbus address 046 to the device.

**Fieldbus address 047**

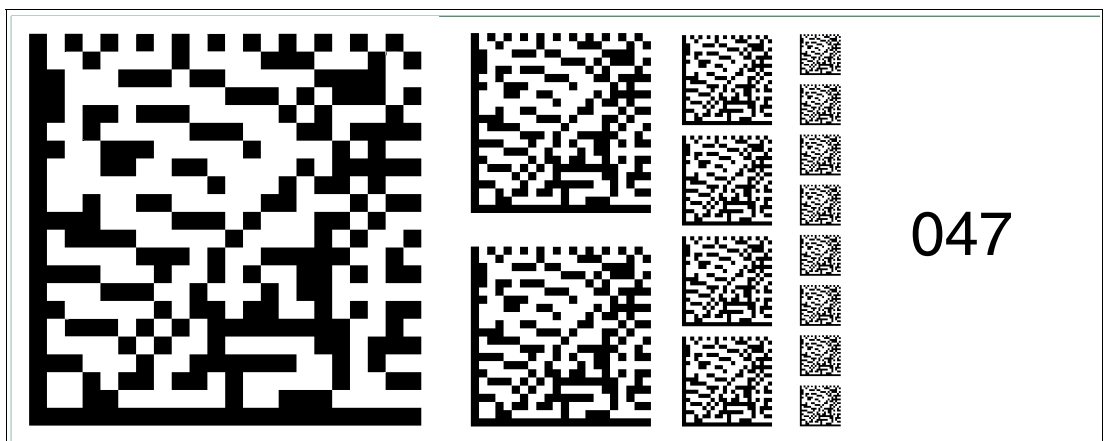

Figure 6.63 The code card "Fieldbus address 047" assigns the fieldbus address 047 to the device.

**Fieldbus address 048**

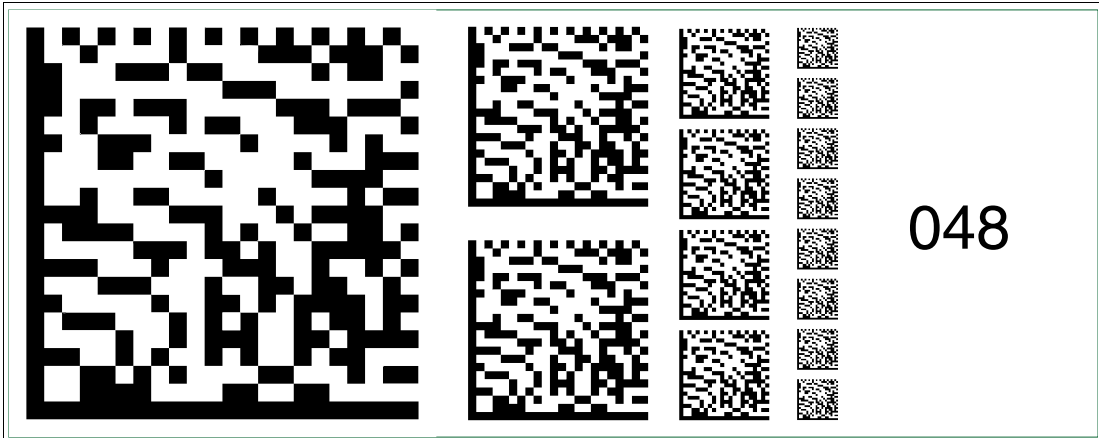

Figure 6.64 The code card "Fieldbus address 048" assigns the fieldbus address 048 to the device.

**Fieldbus address 049**

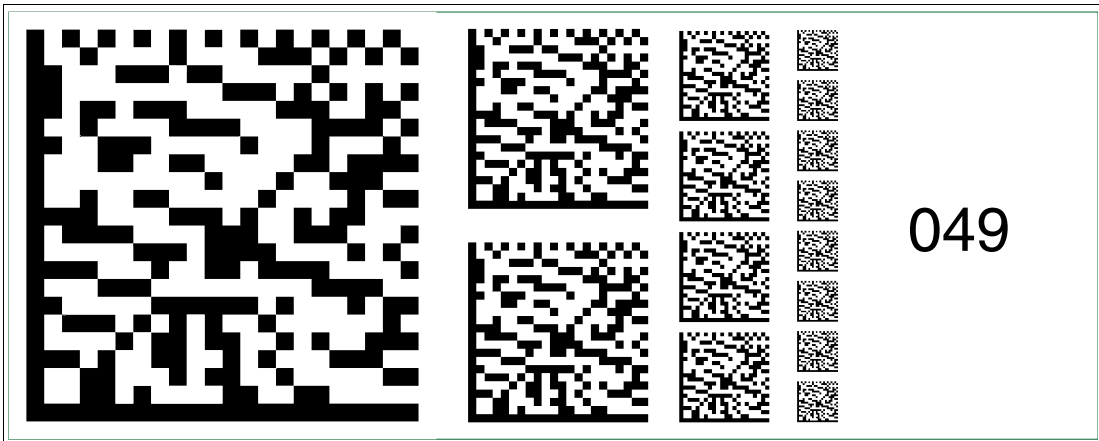

Figure 6.65 The code card "Fieldbus address 049" assigns the fieldbus address 049 to the device.

**Fieldbus address 050**

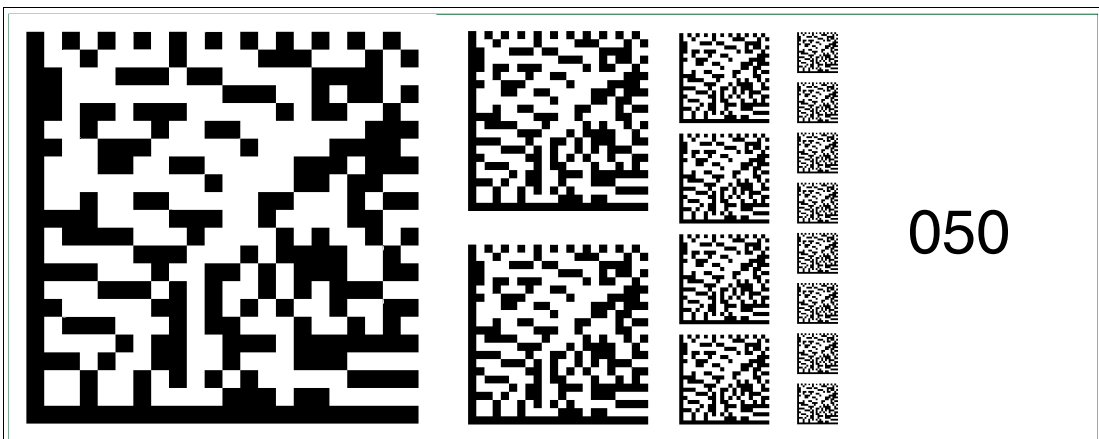

Figure 6.66 The code card "Fieldbus address 050" assigns the fieldbus address 050 to the device.

**Fieldbus address 051**

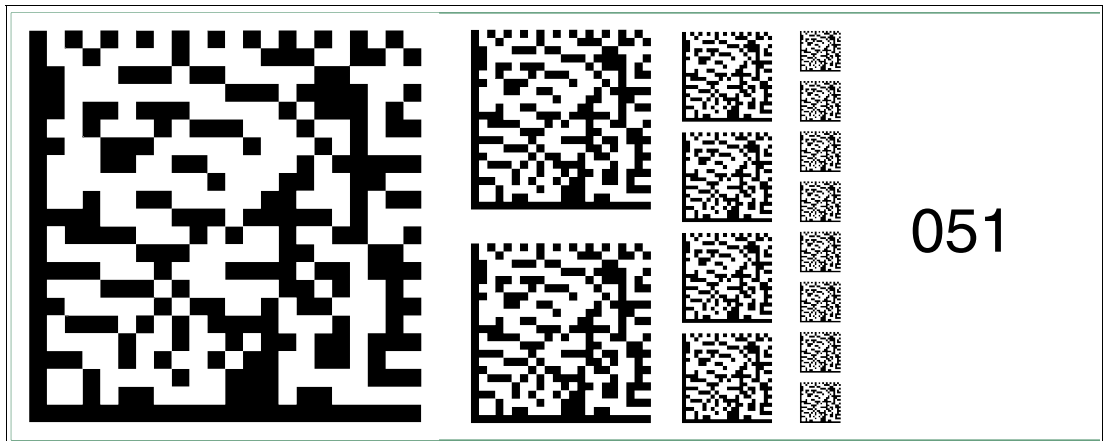

Figure 6.67 The code card "Fieldbus address 051" assigns the fieldbus address 051 to the device.

**Fieldbus address 052**

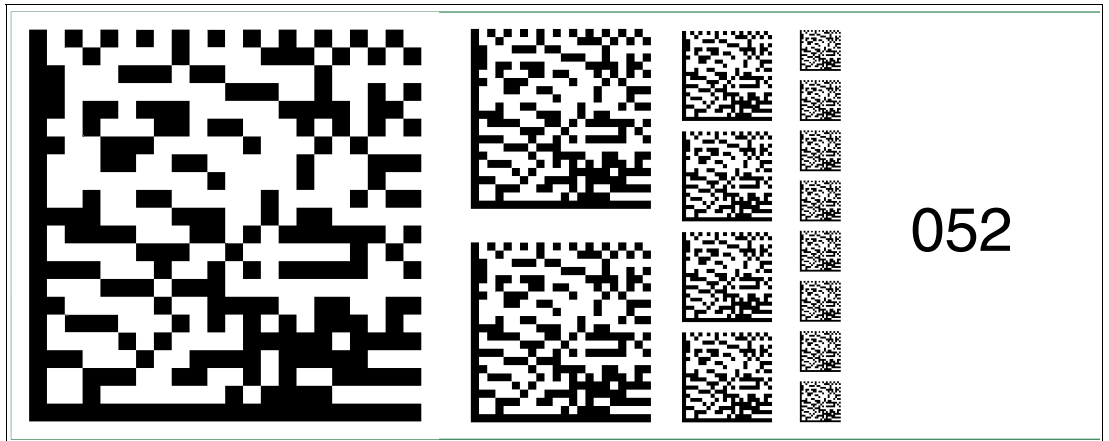

Figure 6.68 The code card "Fieldbus address 052" assigns the fieldbus address 052 to the device.

**Fieldbus address 053**

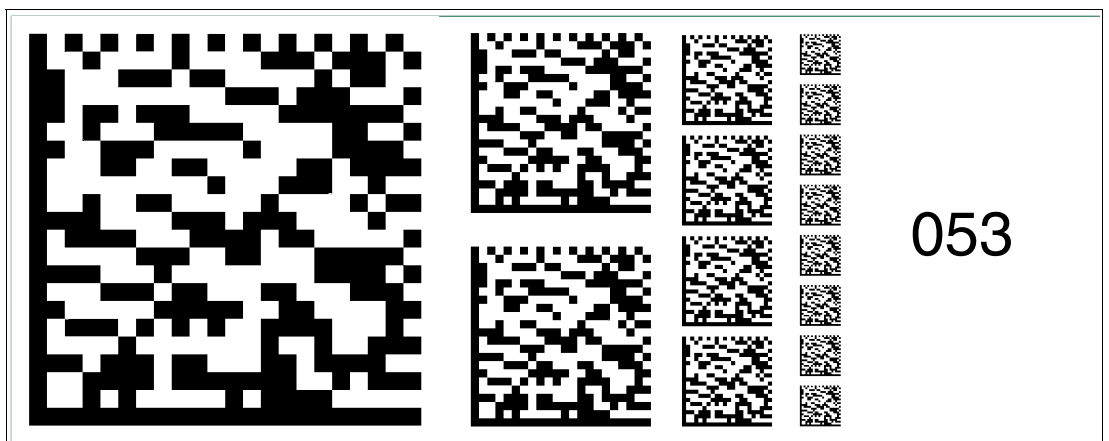

Figure 6.69 The code card "Fieldbus address 053" assigns the fieldbus address 053 to the device.

**Fieldbus address 054**

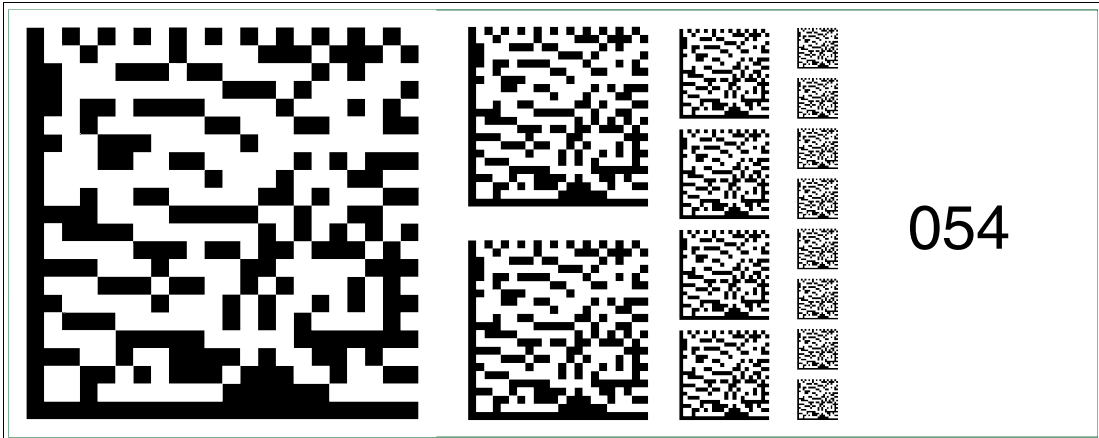

Figure 6.70 The code card "Fieldbus address 054" assigns the fieldbus address 054 to the device.

**Fieldbus address 055**

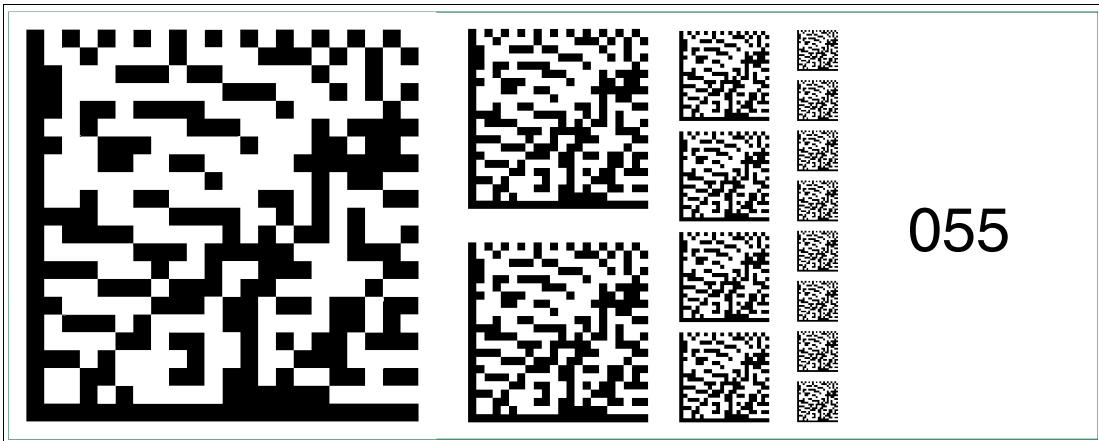

Figure 6.71 The code card "Fieldbus address 055" assigns the fieldbus address 055 to the device.

**Fieldbus address 056**

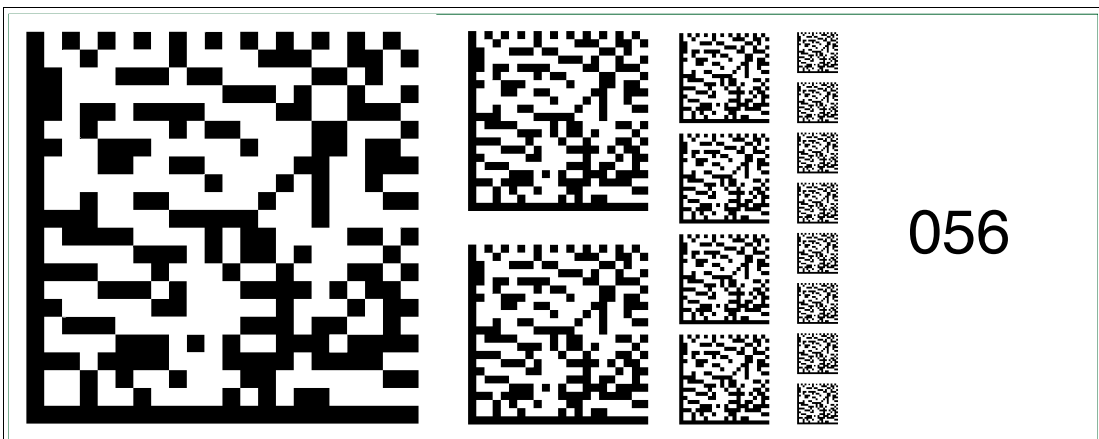

Figure 6.72 The code card "Fieldbus address 056" assigns the fieldbus address 056 to the device.

**Fieldbus address 057**

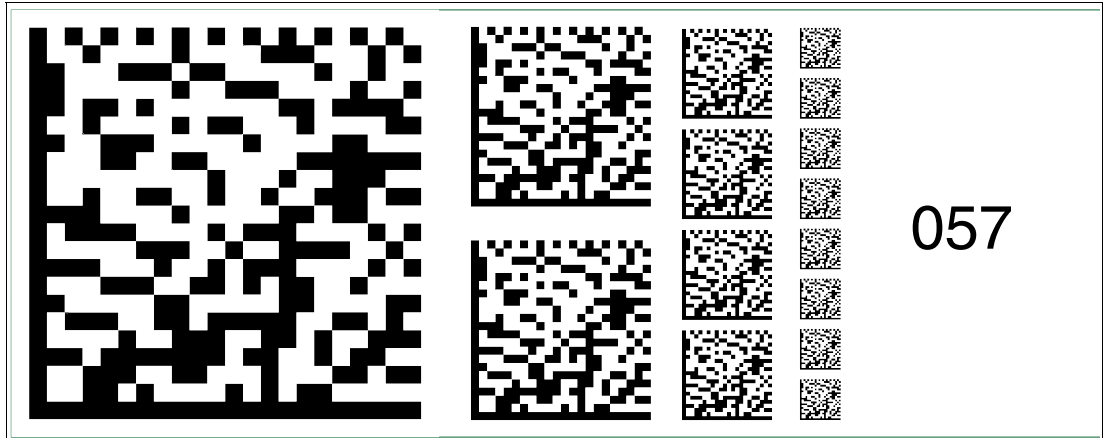

Figure 6.73 The code card "Fieldbus address 057" assigns the fieldbus address 057 to the device.

**Fieldbus address 058**

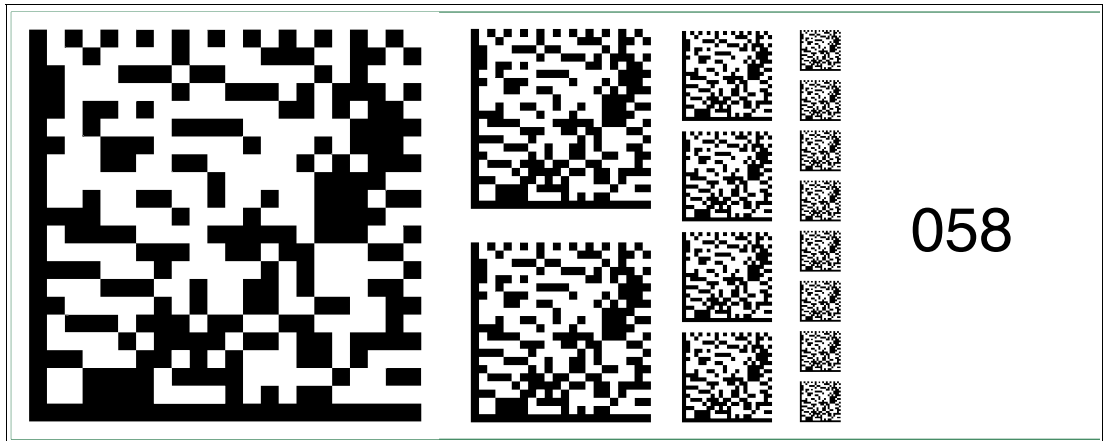

Figure 6.74 The code card "Fieldbus address 058" assigns the fieldbus address 058 to the device.

**Fieldbus address 059**

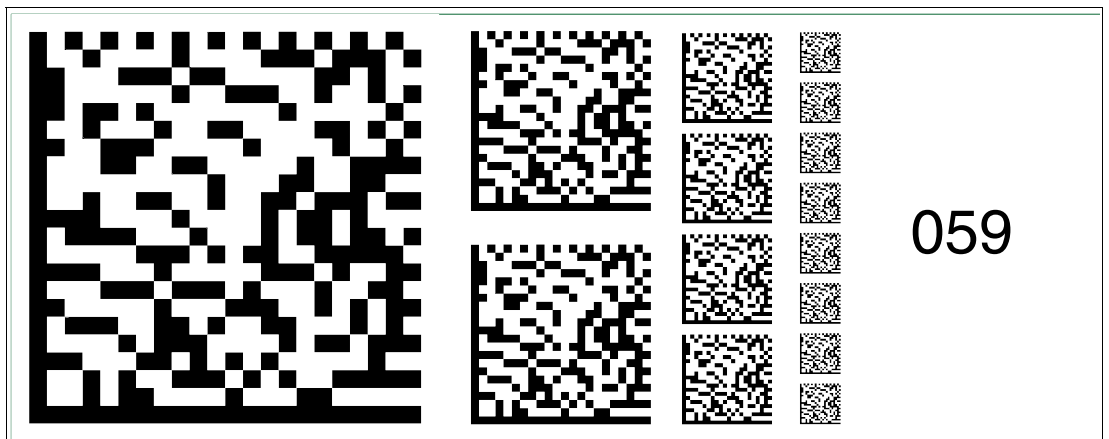

Figure 6.75 Die Codekarte "Feldbusadresse 059" weist dem Gerät die Feldbusadresse 059 zu.

**Fieldbus address 060**

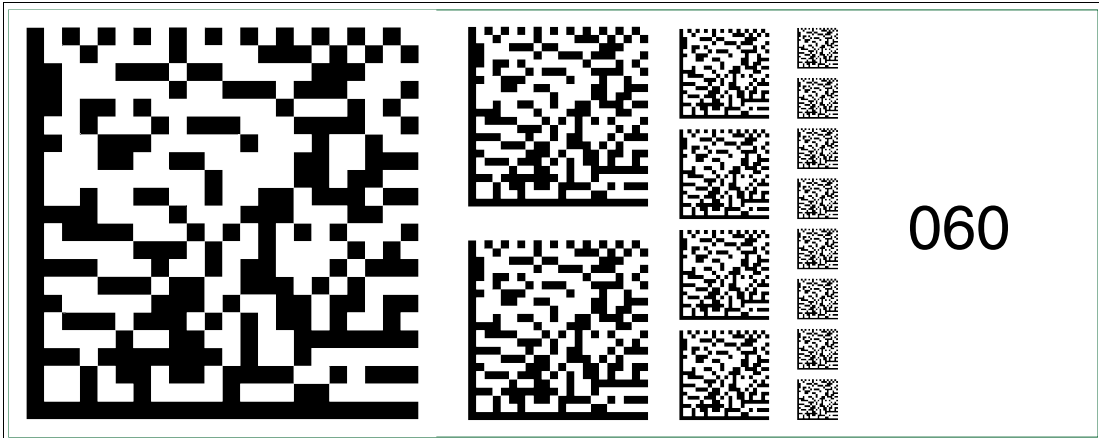

Figure 6.76 The code card "Fieldbus address 060" assigns the fieldbus address 060 to the device.

**Fieldbus address 061**

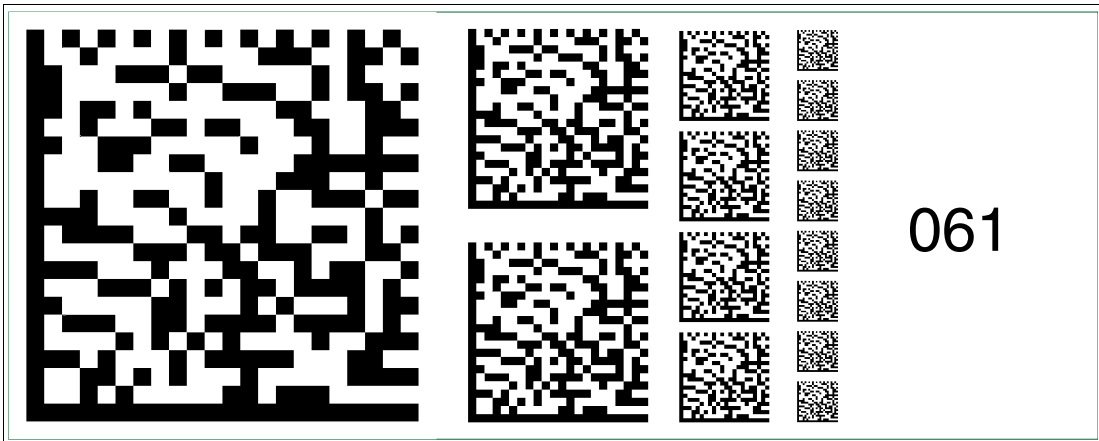

Figure 6.77 The code card "Fieldbus address 061" assigns the fieldbus address 061 to the device.

**Fieldbus address 062**

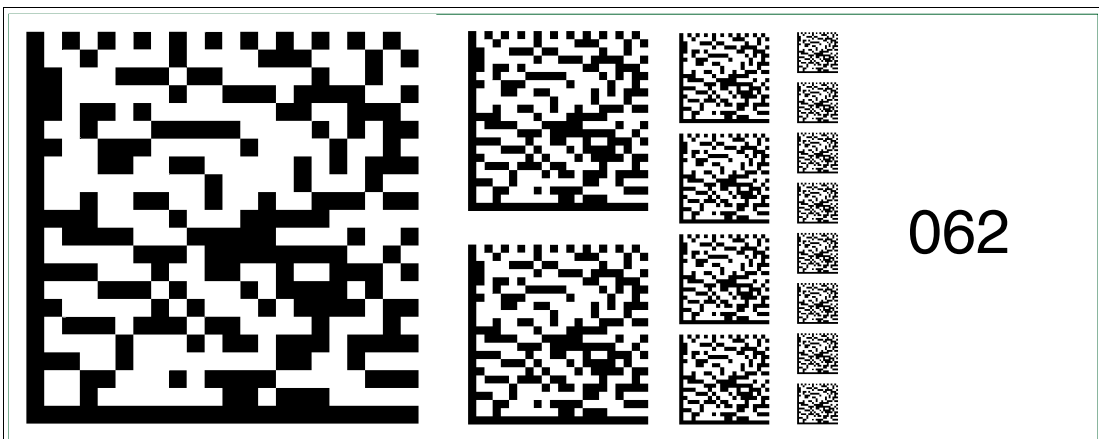

Figure 6.78 The code card "Fieldbus address 062" assigns the fieldbus address 062 to the device.

**Fieldbus address 063**

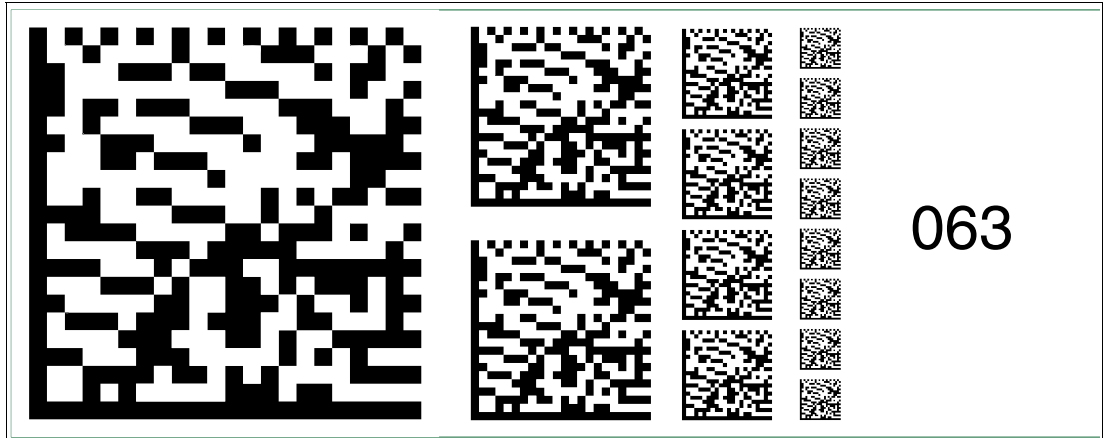

Figure 6.79 The code card "Fieldbus address 063" assigns the fieldbus address 063 to the device.

**Fieldbus address 064**

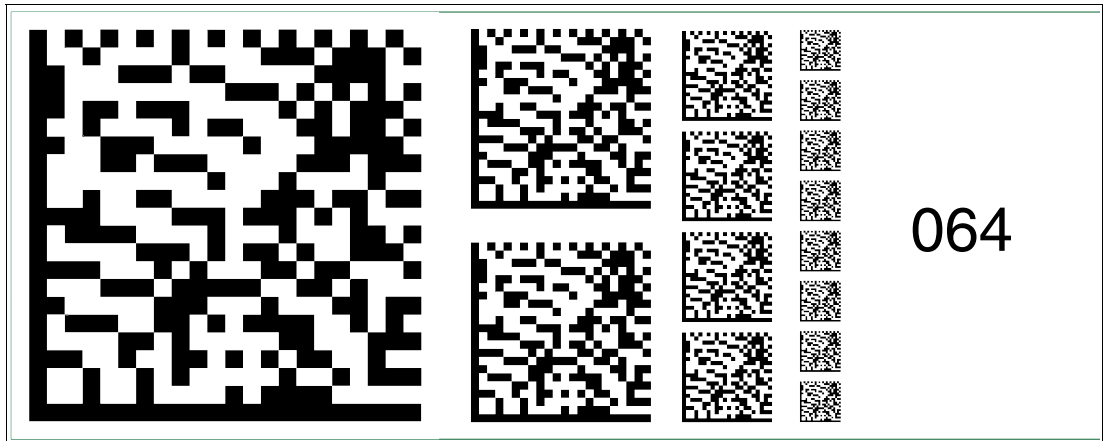

Figure 6.80 The code card "Fieldbus address 064" assigns the fieldbus address 064 to the device.

**Fieldbus address 065**

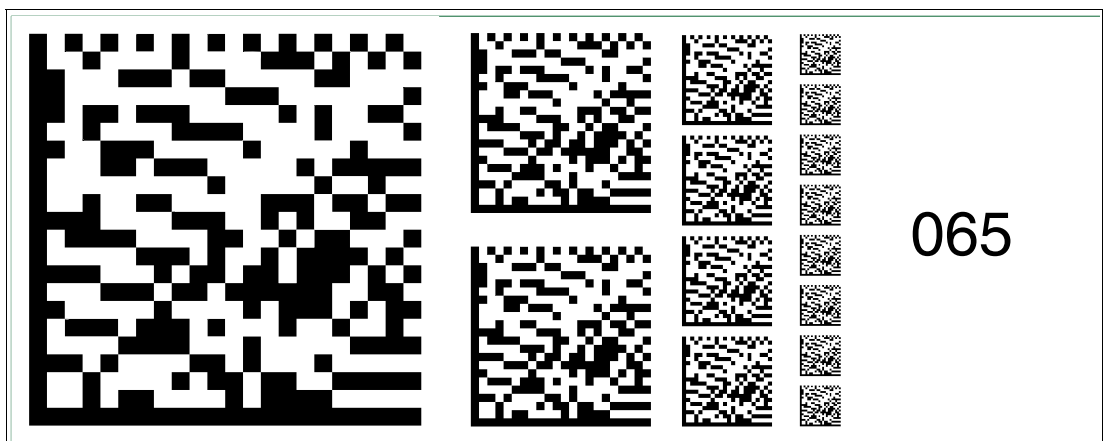

Figure 6.81 The code card "Fieldbus address 065" assigns the fieldbus address 065 to the device.

**Fieldbus address 066**

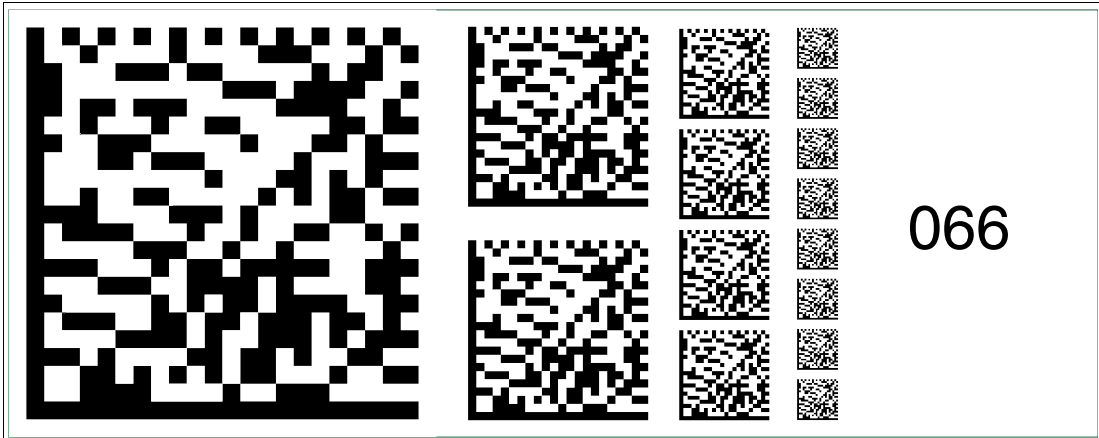

Figure 6.82 The code card "Fieldbus address 066" assigns the fieldbus address 066 to the device.

**Fieldbus address 067**

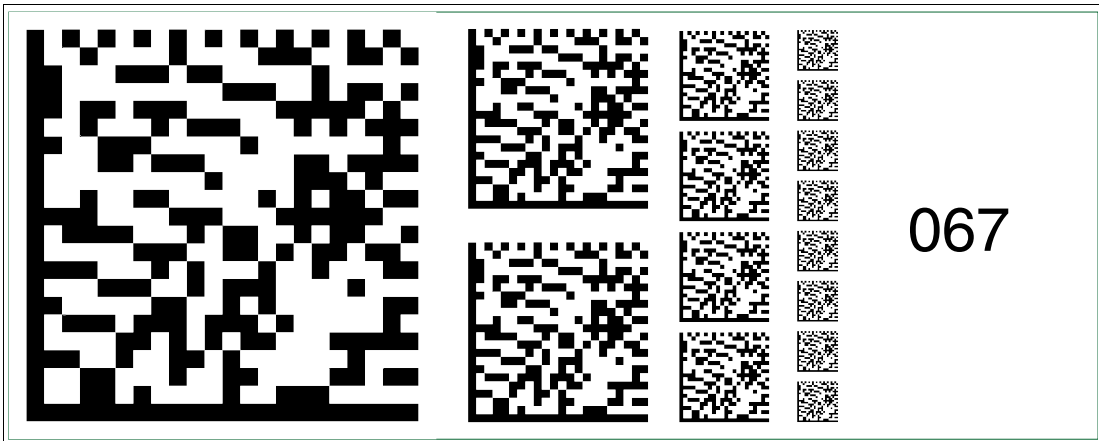

Figure 6.83 The code card "Fieldbus address 067" assigns the fieldbus address 067 to the device.

**Fieldbus address 068**

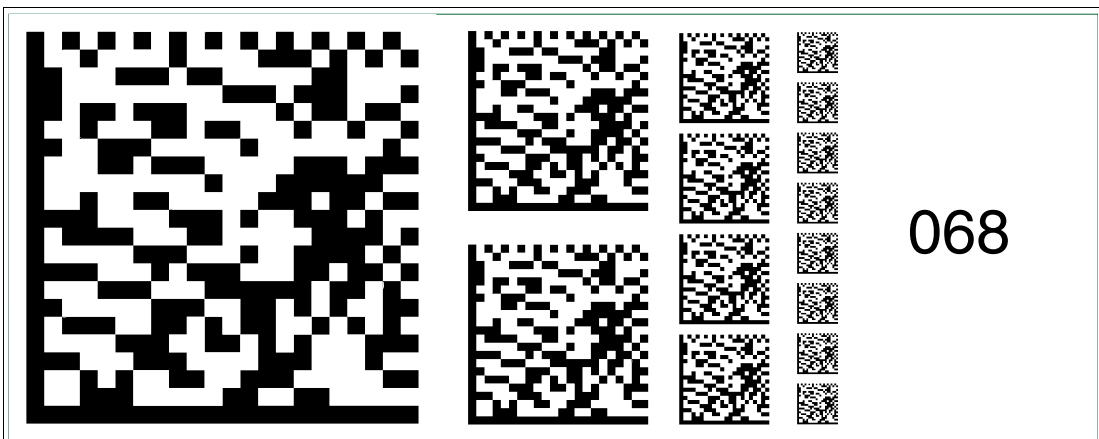

Figure 6.84 The code card "Fieldbus address 068" assigns the fieldbus address 068 to the device.



**Fieldbus address 069**

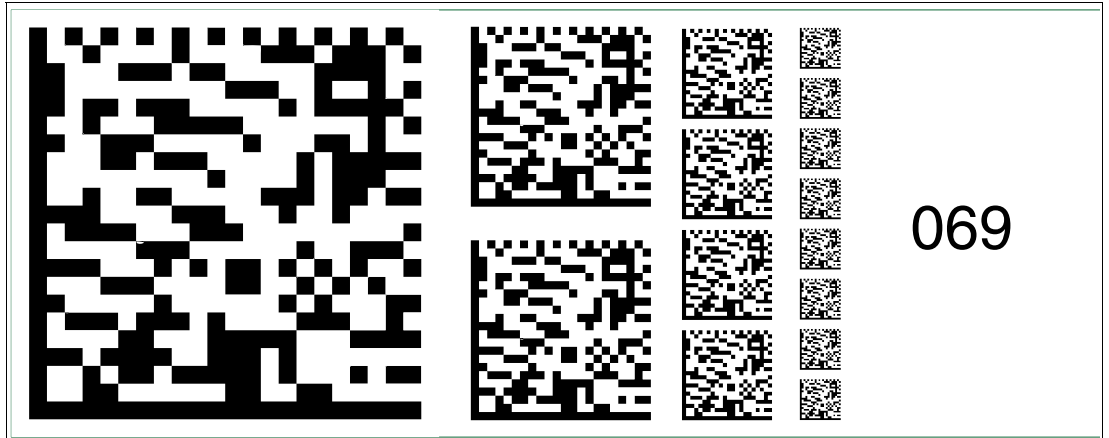

Figure 6.85 The code card "Fieldbus address 069" assigns the fieldbus address 069 to the device.

**Fieldbus address 070**

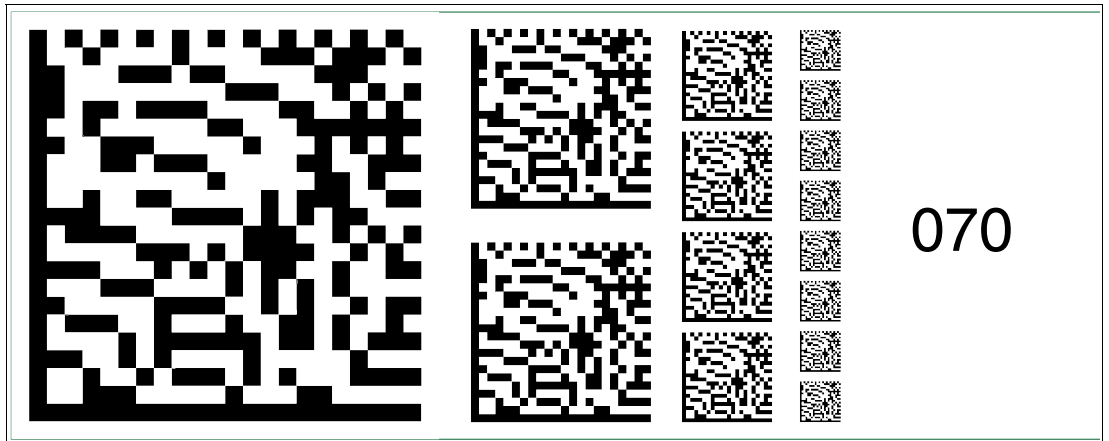

Figure 6.86 The code card "Fieldbus address 070" assigns the fieldbus address 070 to the device.

**Fieldbus address 071**

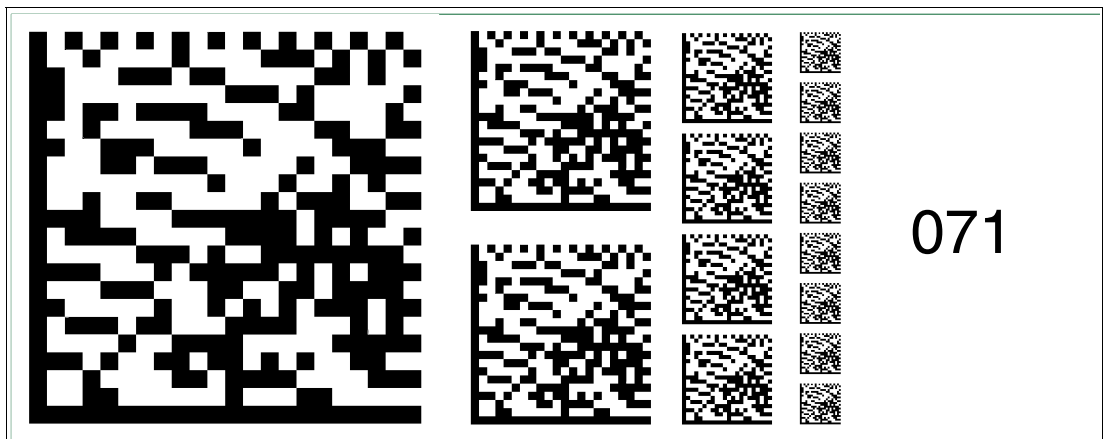

Figure 6.87 The code card "Fieldbus address 071" assigns the fieldbus address 071 to the device.

**Fieldbus address 072**

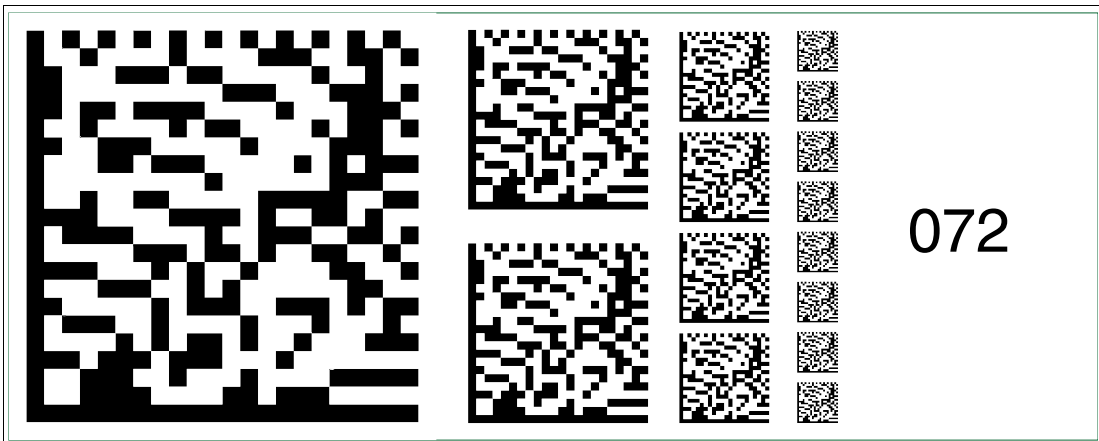

Figure 6.88 The code card "Fieldbus address 072" assigns the fieldbus address 072 to the device.

**Fieldbus address 073**

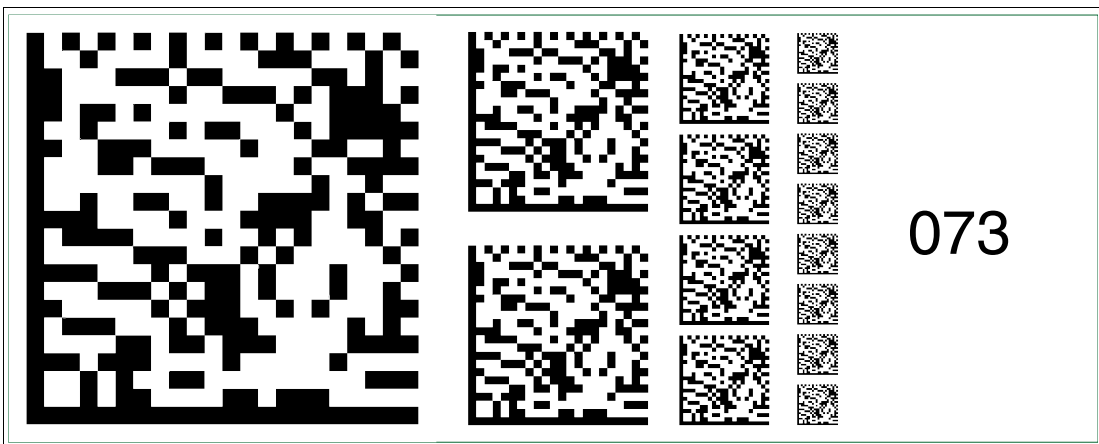

Figure 6.89 The code card "Fieldbus address 073" assigns the fieldbus address 073 to the device.

**Fieldbus address 074**

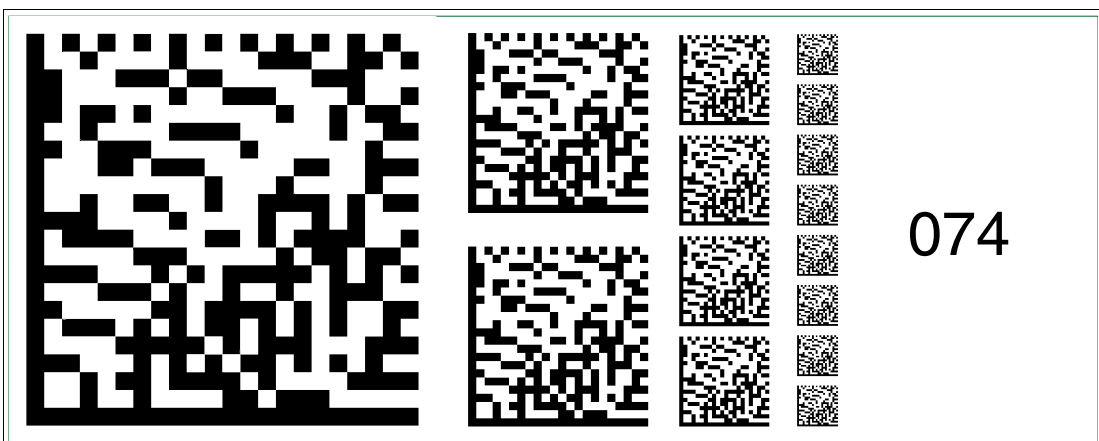

Figure 6.90 The code card "Fieldbus address 074" assigns the fieldbus address 074 to the device.

**Fieldbus address 075**

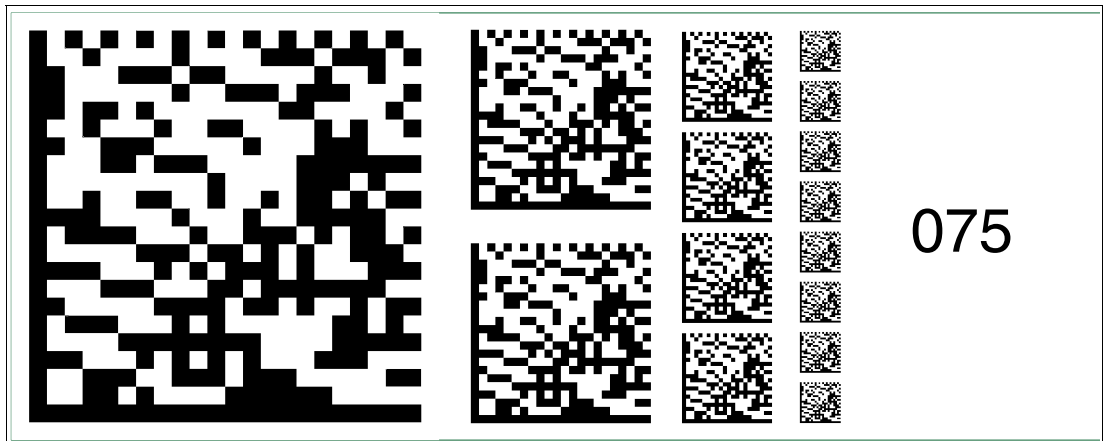

Figure 6.91 The code card "Fieldbus address 075" assigns the fieldbus address 075 to the device.

**Fieldbus address 076**

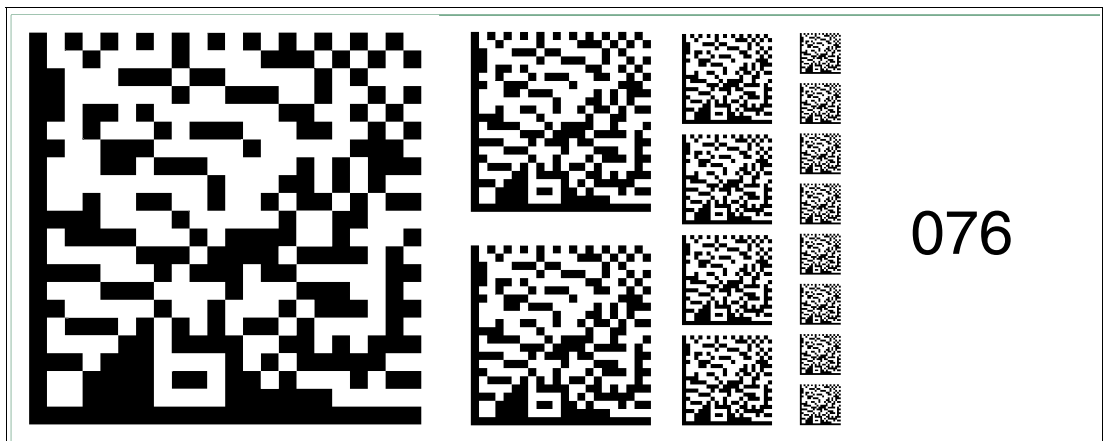

Figure 6.92 The code card "Fieldbus address 076" assigns the fieldbus address 076 to the device.

**Fieldbus address 077**

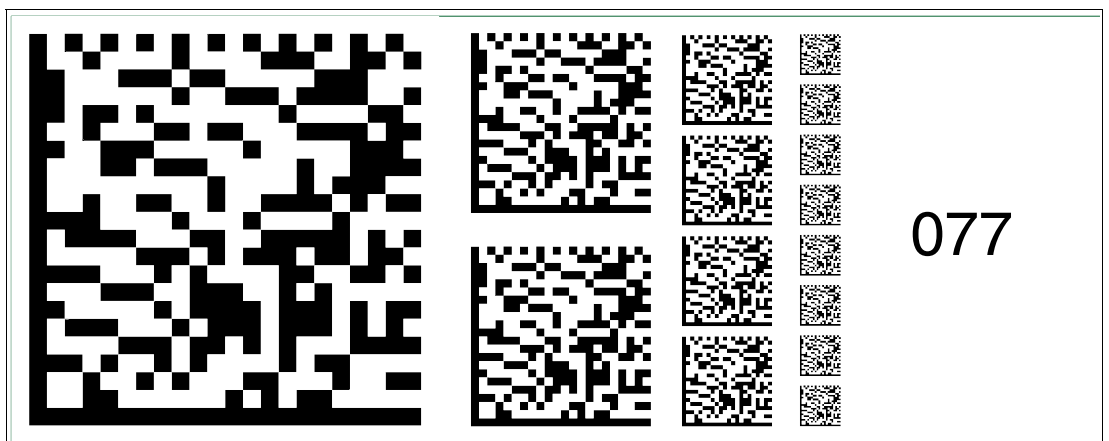

Figure 6.93 The code card "Fieldbus address 077" assigns the fieldbus address 077 to the device.

**Fieldbus address 078**

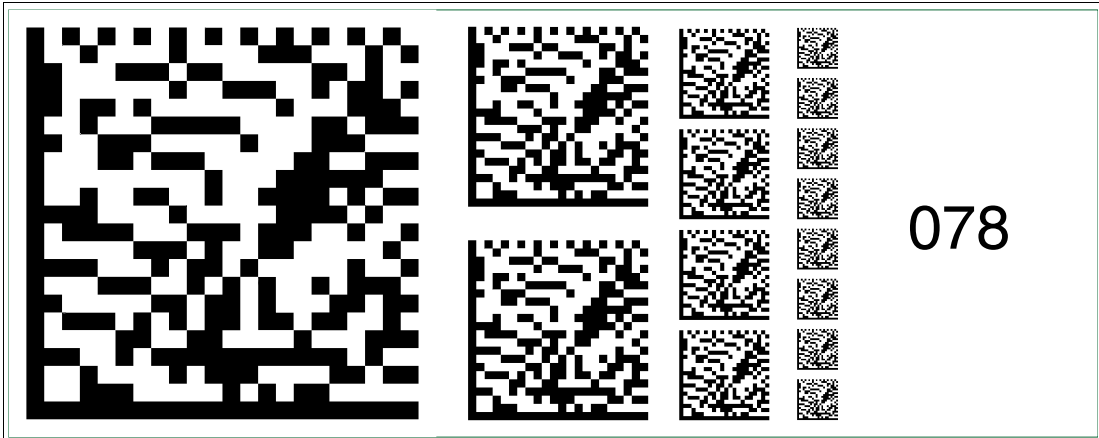

Figure 6.94 The code card "Fieldbus address 078" assigns the fieldbus address 078 to the device.

**Fieldbus address 079**

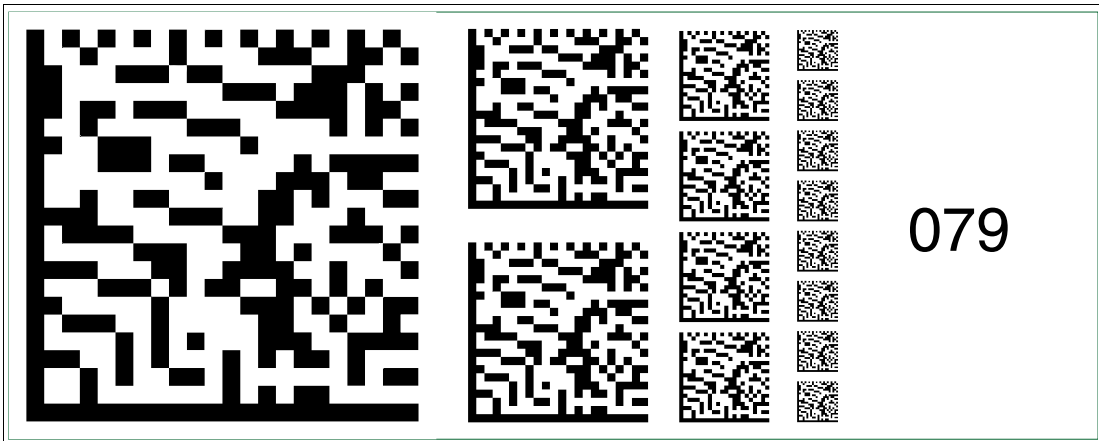

Figure 6.95 The code card "Fieldbus address 079" assigns the fieldbus address 079 to the device.

**Fieldbus address 080**

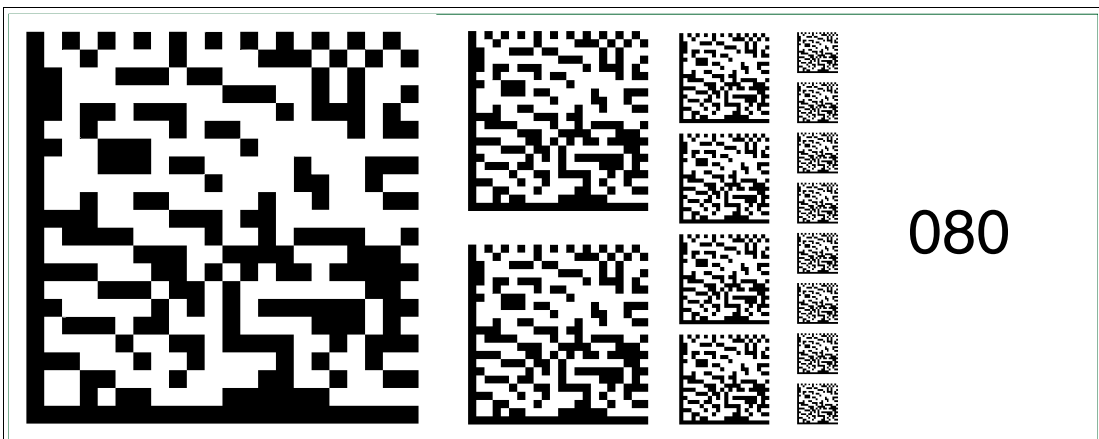

Figure 6.96 The code card "Fieldbus address 080" assigns the fieldbus address 080 to the device.

**Fieldbus address 081**

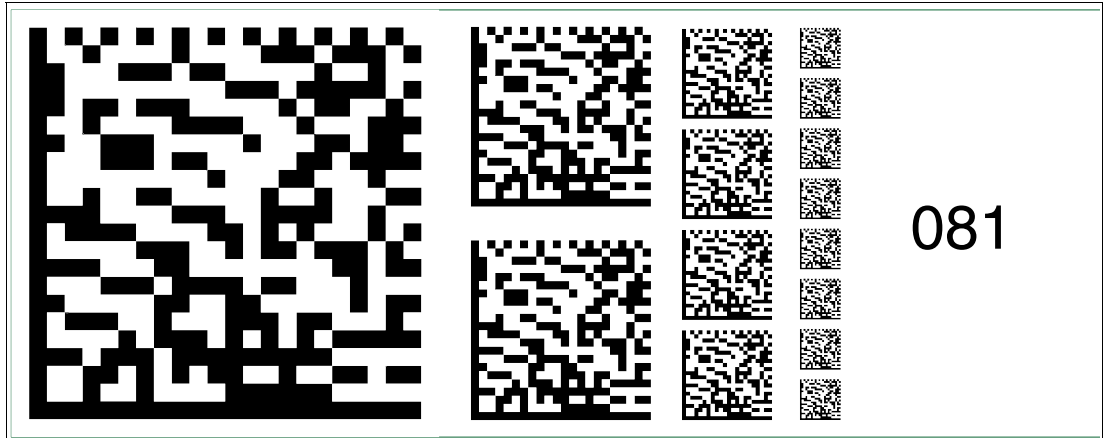

Figure 6.97 The code card "Fieldbus address 081" assigns the fieldbus address 081 to the device.

**Fieldbus address 082**

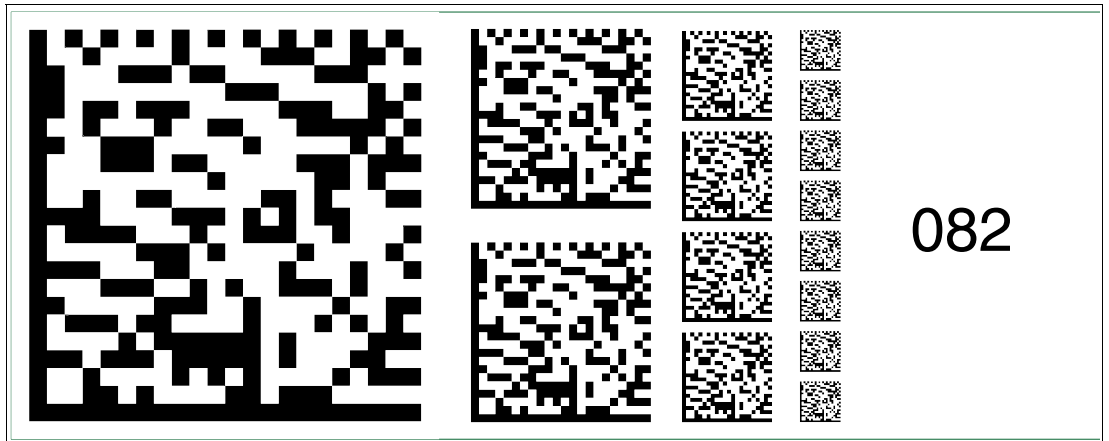

Figure 6.98 The code card "Fieldbus address 082" assigns the fieldbus address 082 to the device.

**Fieldbus address 083**

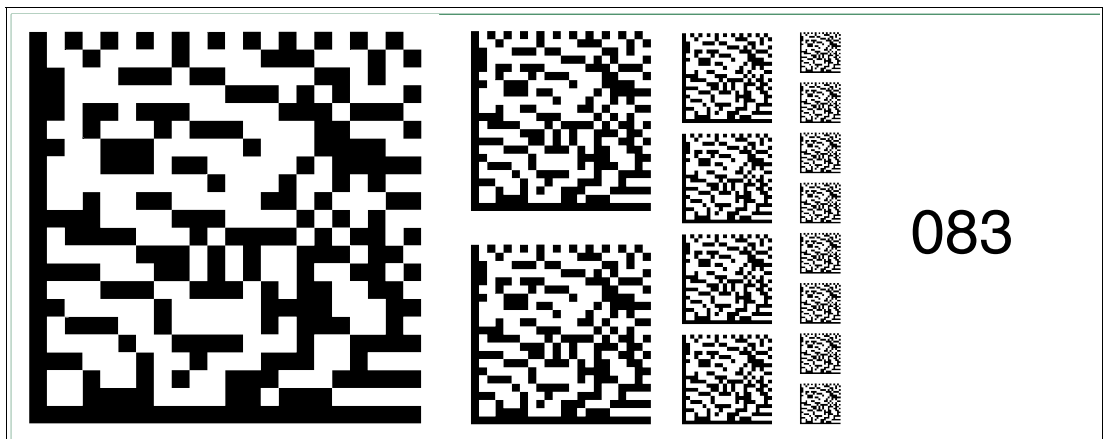

Figure 6.99 The code card "Fieldbus address 083" assigns the fieldbus address 083 to the device.

**Fieldbus address 084**

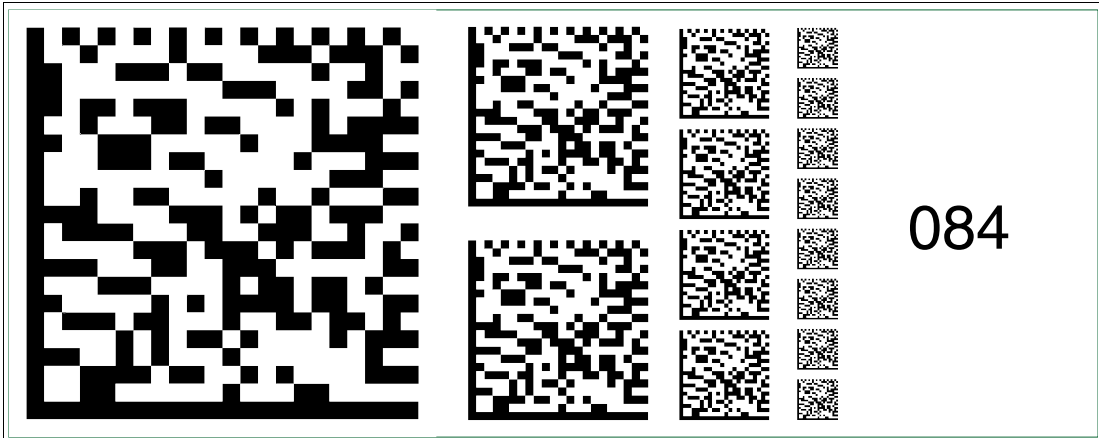

Figure 6.100 The code card "Fieldbus address 084" assigns the fieldbus address 084 to the device.

**Fieldbus address 085**

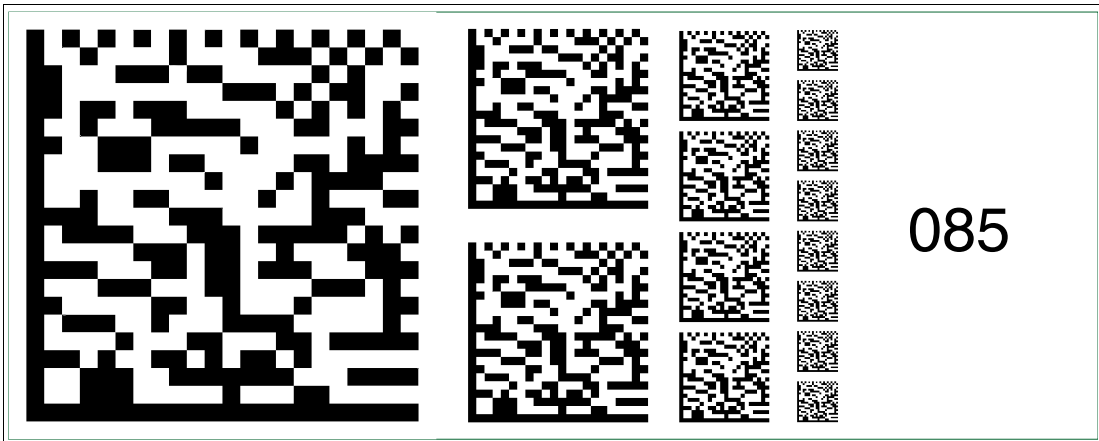

Figure 6.101 The code card "Fieldbus address 085" assigns the fieldbus address 085 to the device.

**Fieldbus address 086**

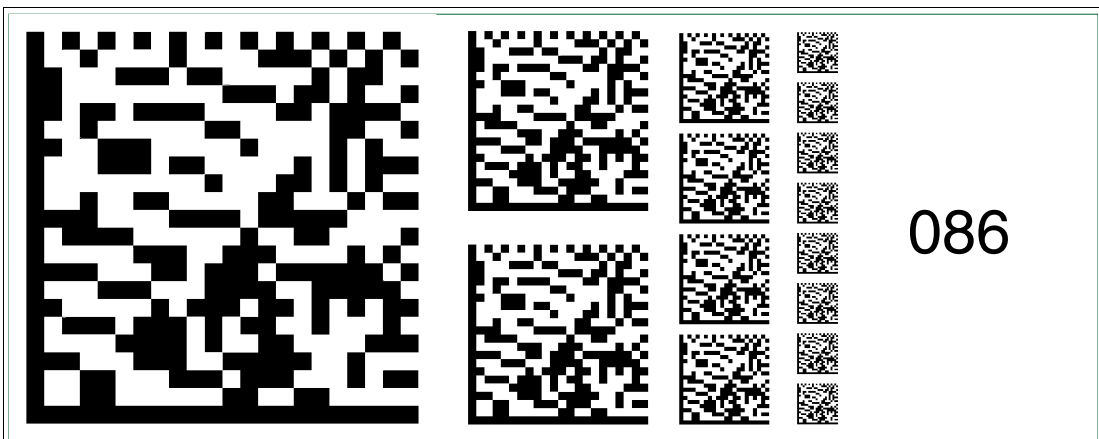

Figure 6.102 The code card "Fieldbus address 086" assigns the fieldbus address 086 to the device.

**Fieldbus address 087**

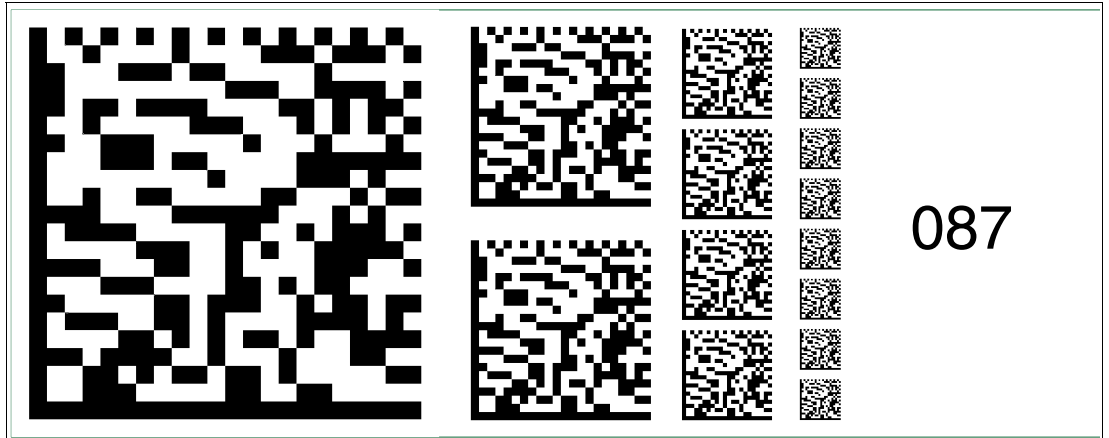

Figure 6.103 The code card "Fieldbus address 087" assigns the fieldbus address 087 to the device.

**Fieldbus address 088**

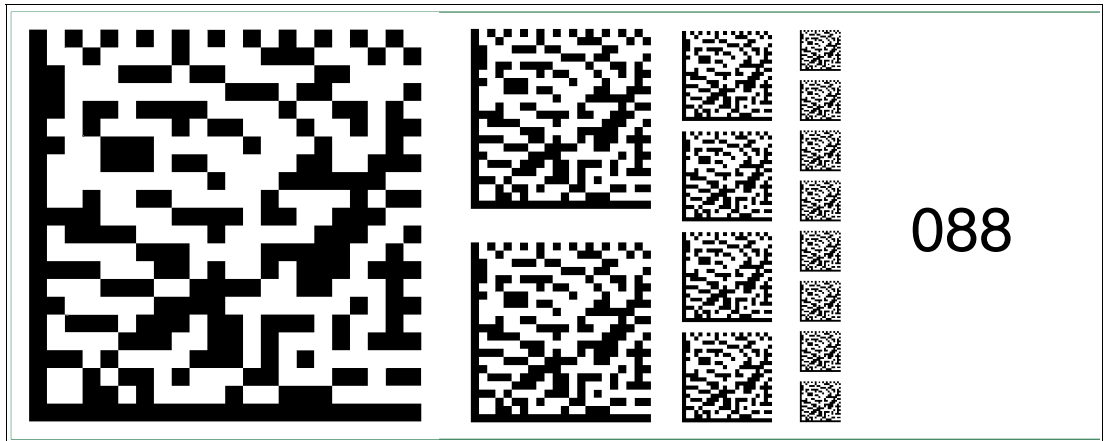

Figure 6.104 The code card "Fieldbus address 088" assigns the fieldbus address 088 to the device.

**Fieldbus address 089**

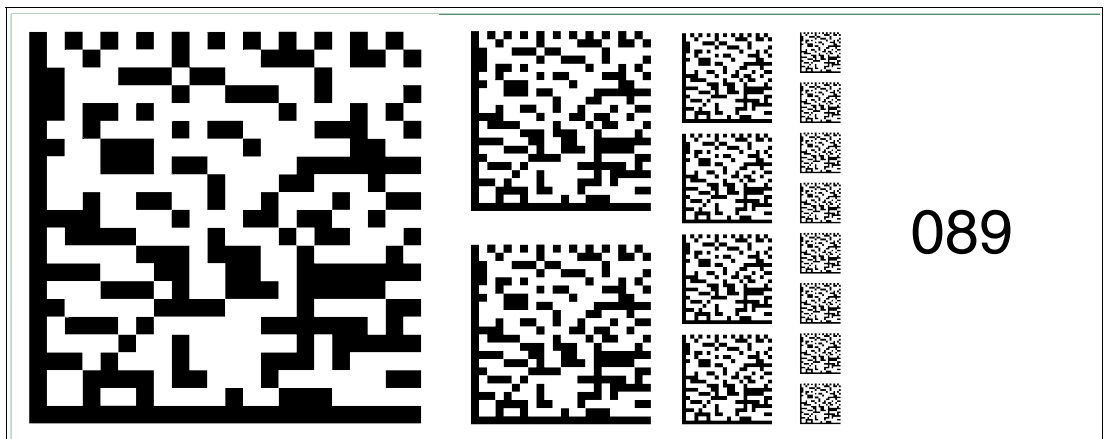

Figure 6.105 The code card "Fieldbus address 089" assigns the fieldbus address 089 to the device.

**Fieldbus address 090**

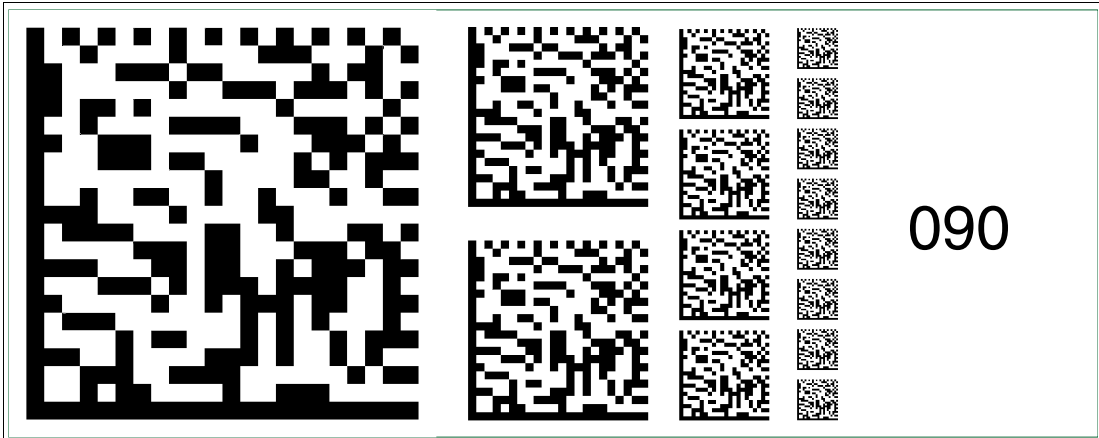

Figure 6.106 The code card "Fieldbus address 090" assigns the fieldbus address 090 to the device.

**Fieldbus address 091**

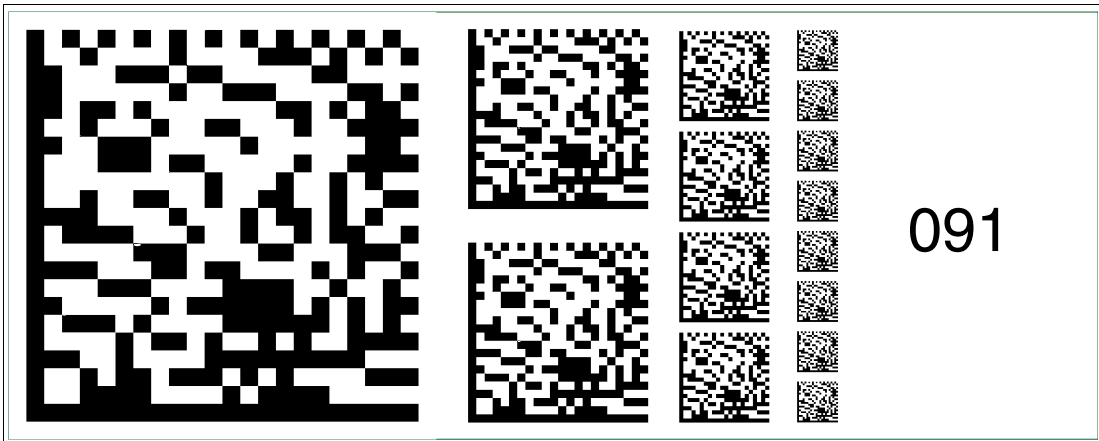

Figure 6.107 The code card "Fieldbus address 091" assigns the fieldbus address 091 to the device.

**Fieldbus address 092**

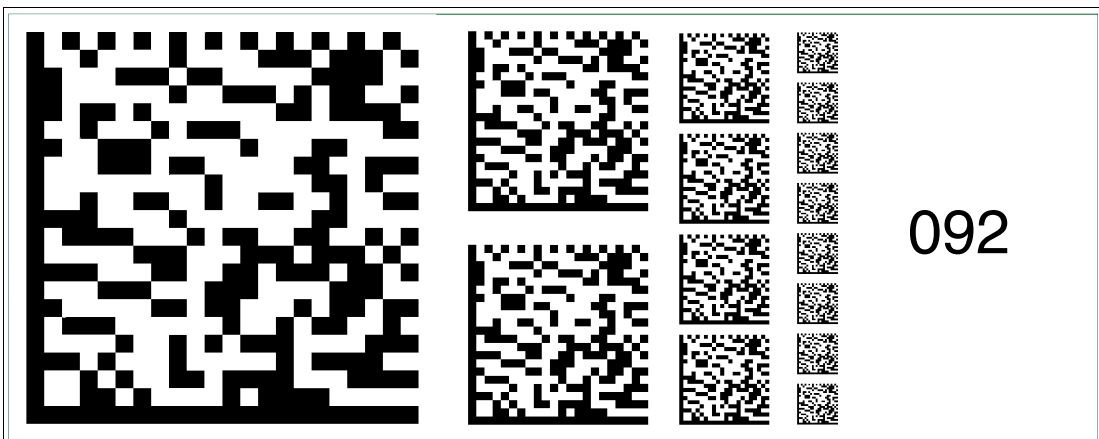

Figure 6.108 The code card "Fieldbus address 092" assigns the fieldbus address 092 to the device.



**Fieldbus address 093**

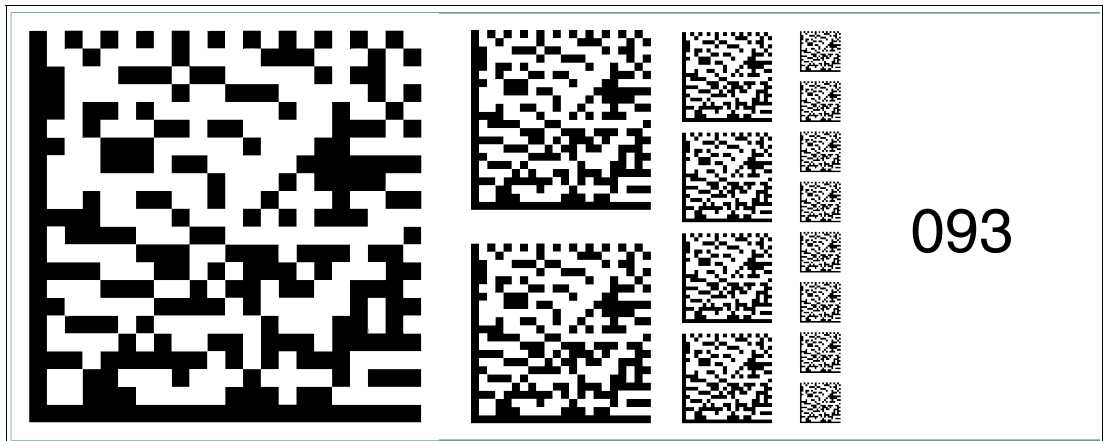

Figure 6.109 The code card "Fieldbus address 093" assigns the fieldbus address 093 to the device.

**Fieldbus address 094**

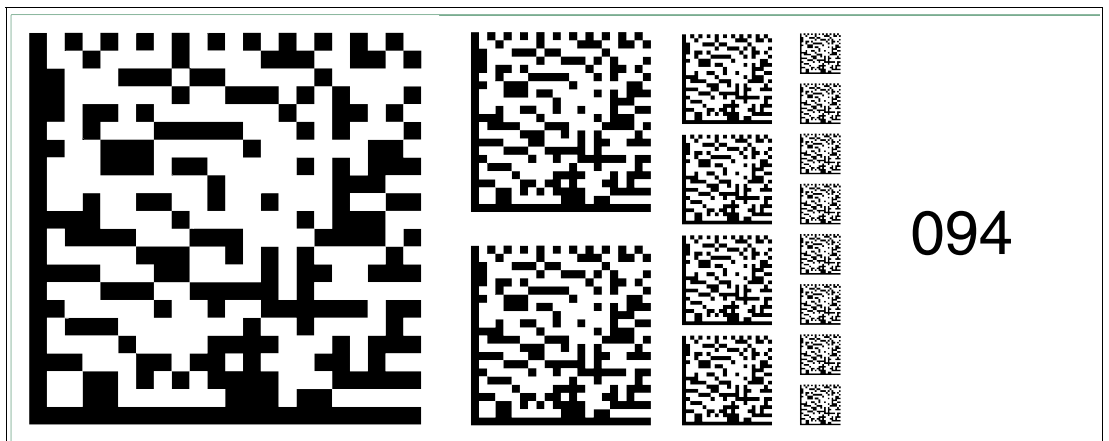

Figure 6.110 The code card "Fieldbus address 094" assigns the fieldbus address 094 to the device.

**Fieldbus address 095**

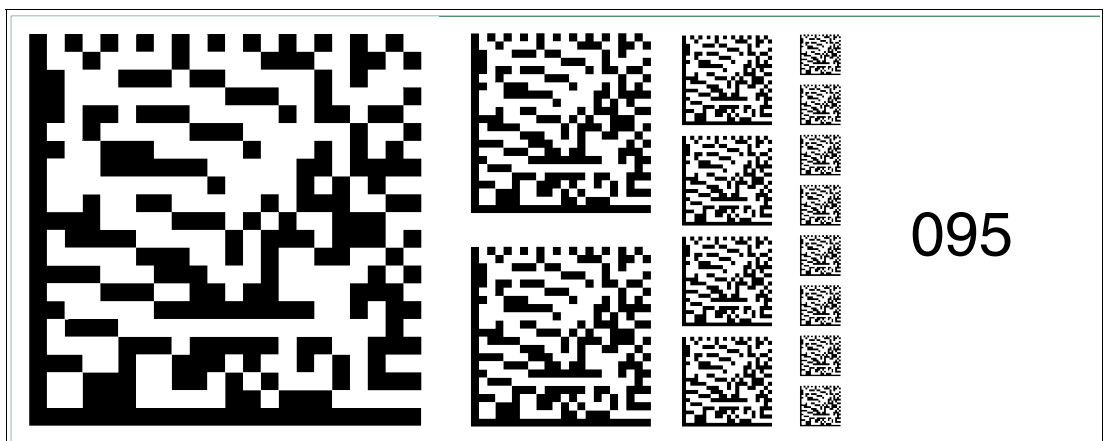

Figure 6.111 The code card "Fieldbus address 095" assigns the fieldbus address 095 to the device.

**Fieldbus address 096**

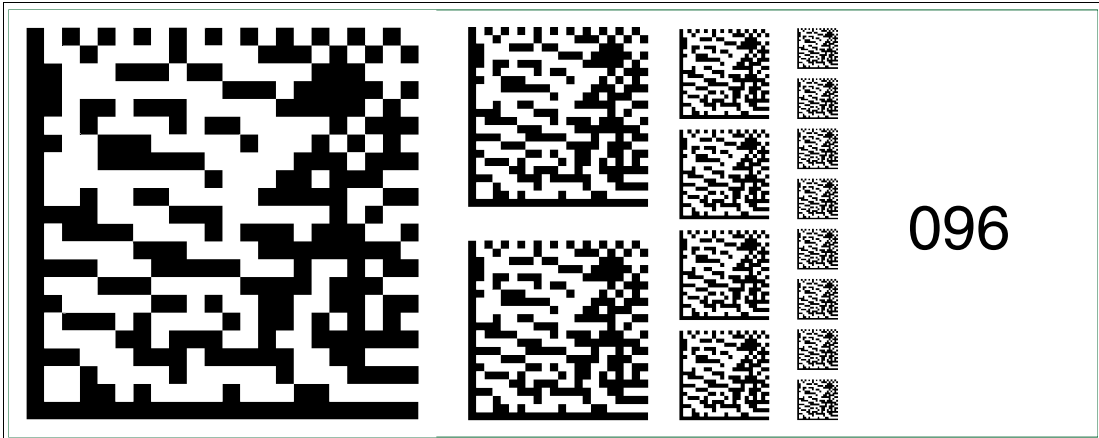

Figure 6.112 The code card "Fieldbus address 096" assigns the fieldbus address 096 to the device.

**Fieldbus address 097**

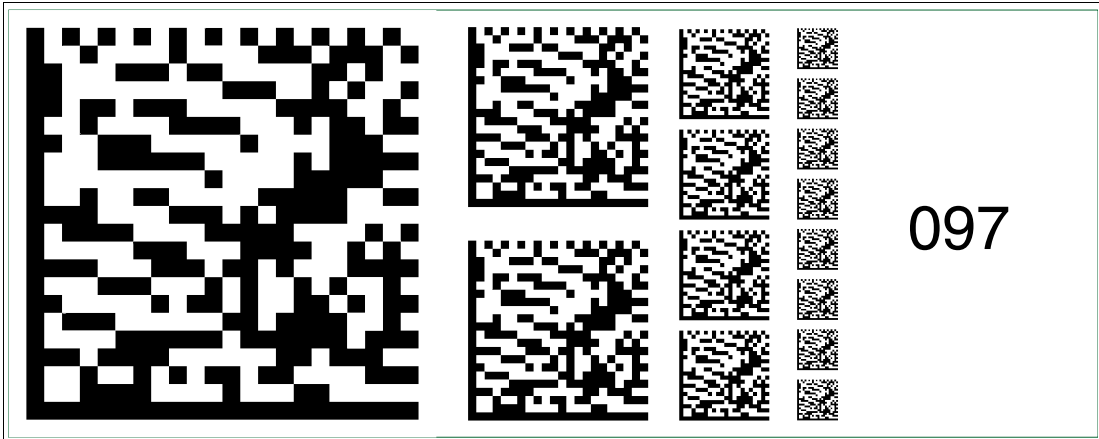

Figure 6.113 The code card "Fieldbus address 097" assigns the fieldbus address 097 to the device.

**Fieldbus address 098**

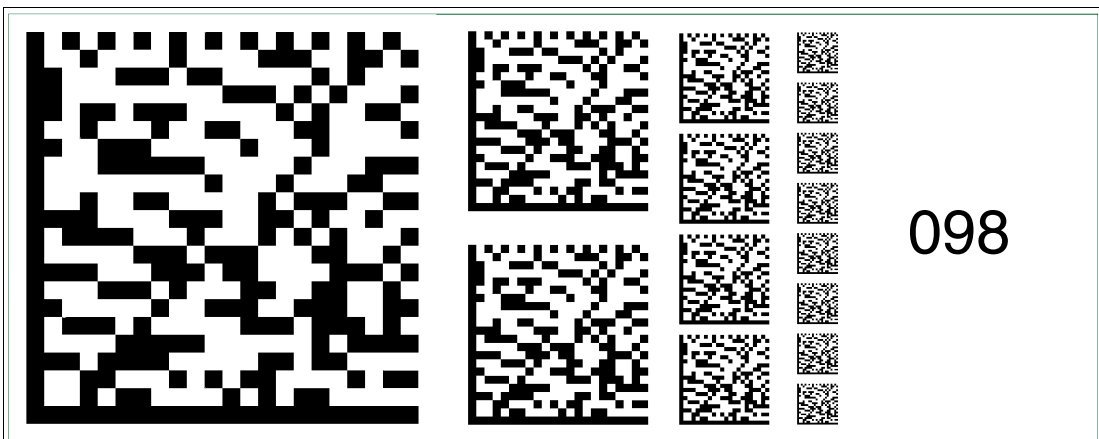

Figure 6.114 The code card "Fieldbus address 098" assigns the fieldbus address 098 to the device.

**Fieldbus address 099**

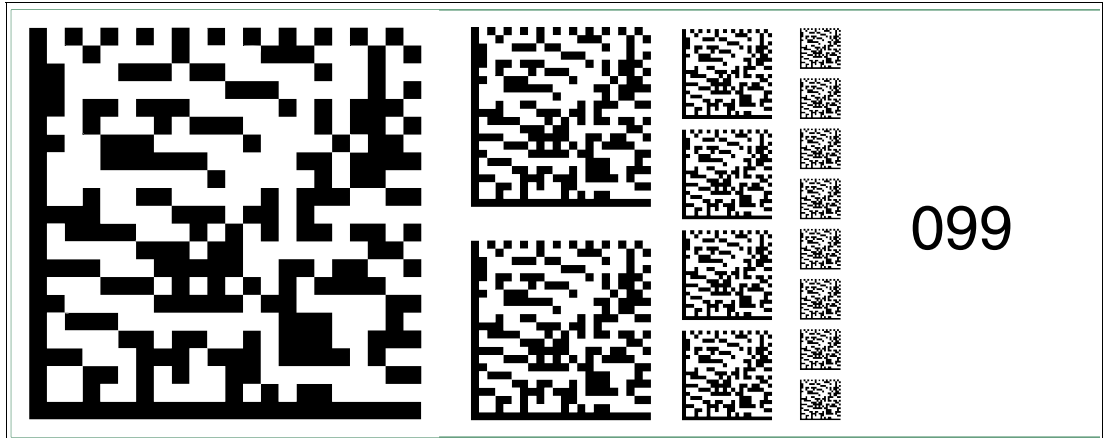

Figure 6.115 The code card "Fieldbus address 099" assigns the fieldbus address 099 to the device.

**Fieldbus address 100**

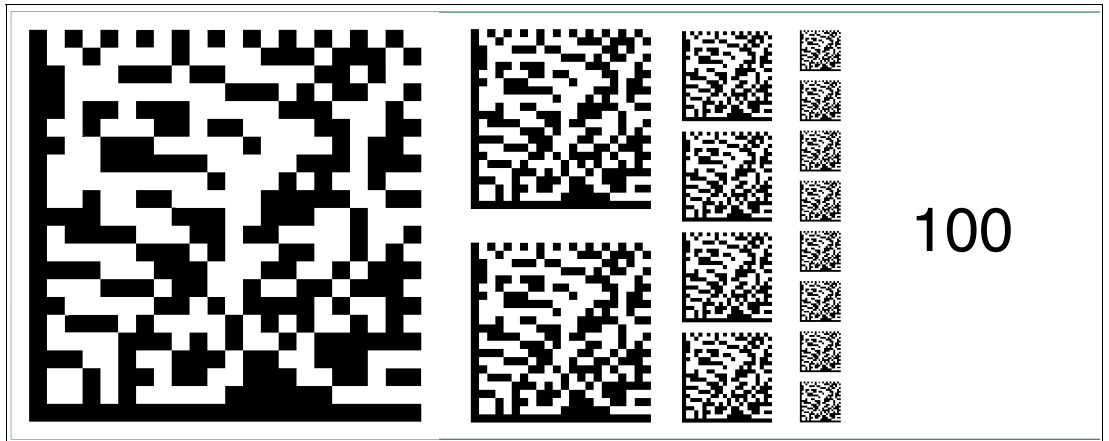

Figure 6.116 The code card "Fieldbus address 100" assigns the fieldbus address 100 to the device.

**Fieldbus address 101**

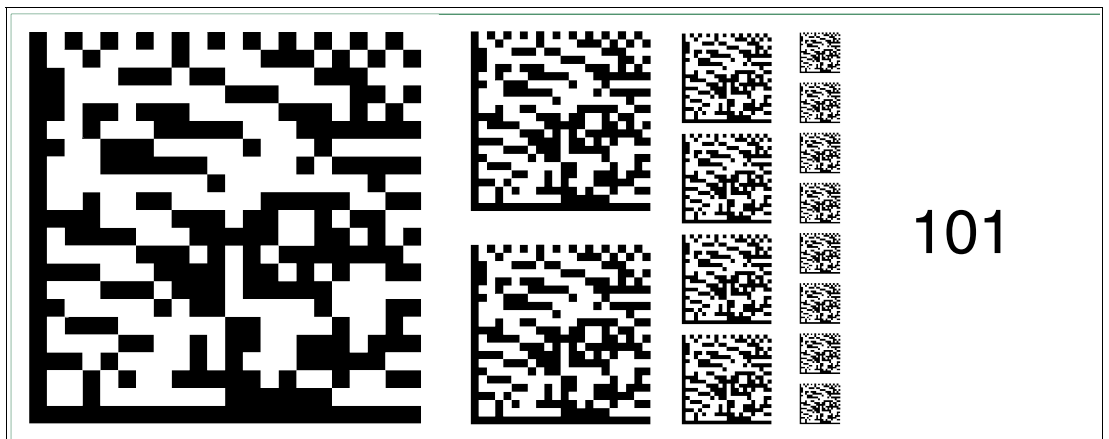

Figure 6.117 The code card "Fieldbus address 101" assigns the fieldbus address 101 to the device.

**Fieldbus address 102**

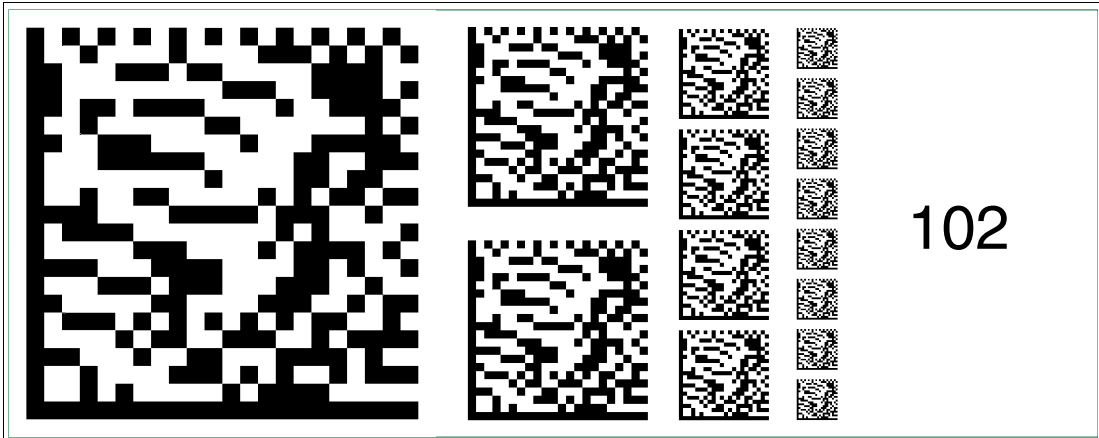

Figure 6.118 The code card "Fieldbus address 102" assigns the fieldbus address 102 to the device.

**Fieldbus address 103**

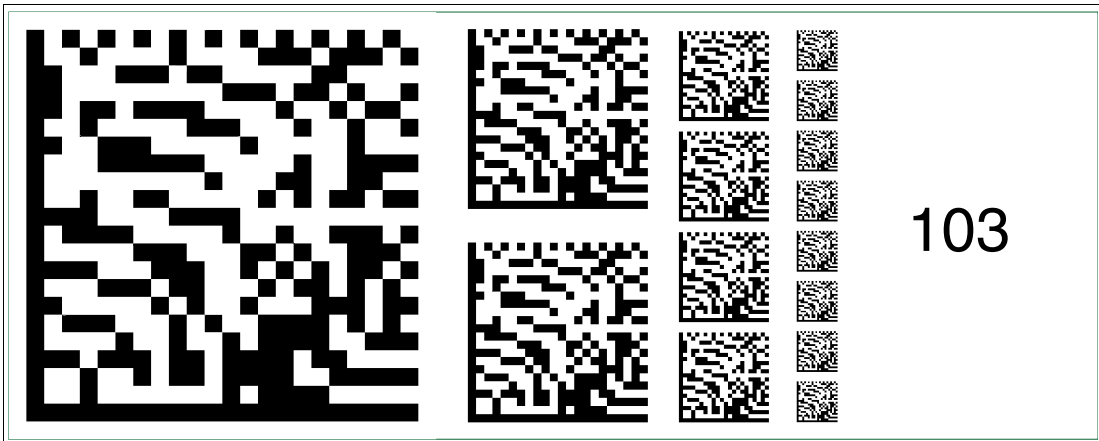

Figure 6.119 The code card "Fieldbus address 103" assigns the fieldbus address 103 to the device.

**Fieldbus address 104**



Figure 6.120 The code card "Fieldbus address 104" assigns the fieldbus address 104 to the device.

**Fieldbus address 105**

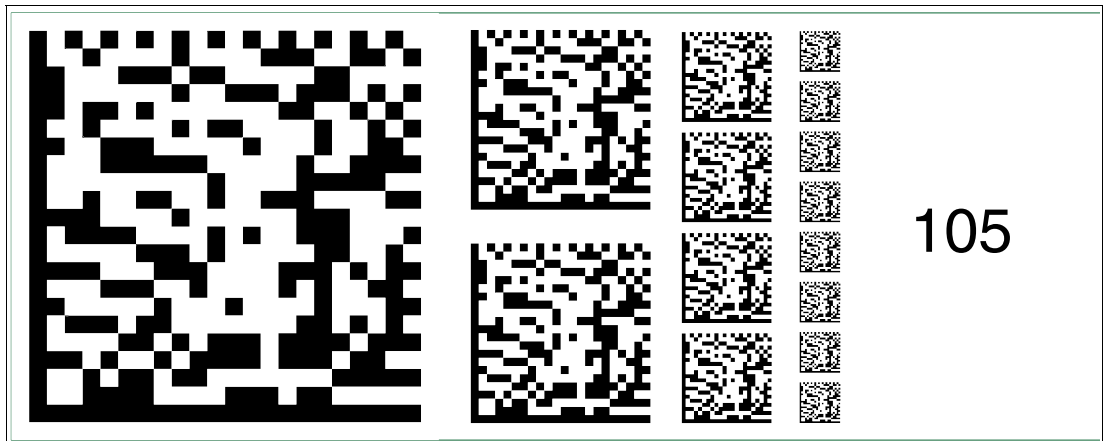

Figure 6.121 The code card "Fieldbus address 105" assigns the fieldbus address 105 to the device.

**Fieldbus address 106**

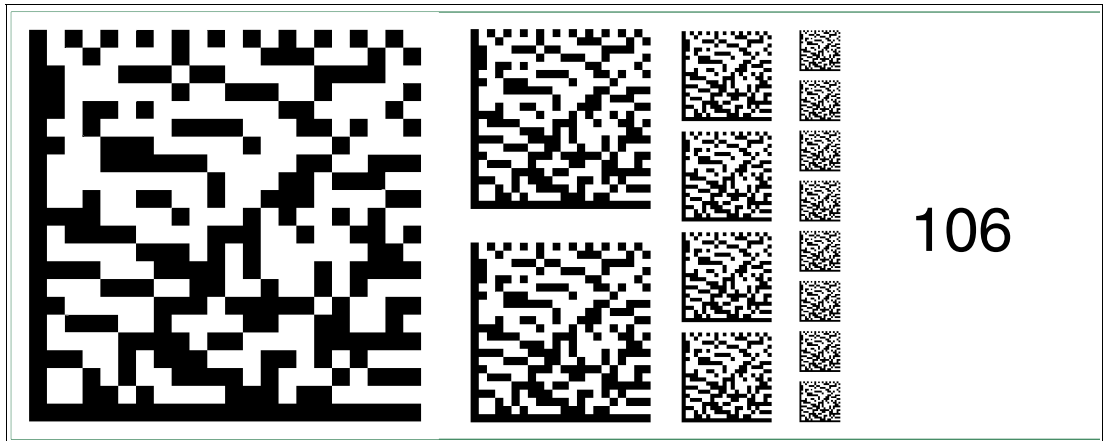

Figure 6.122 The code card "Fieldbus address 106" assigns the fieldbus address 106 to the device.

**Fieldbus address 107**

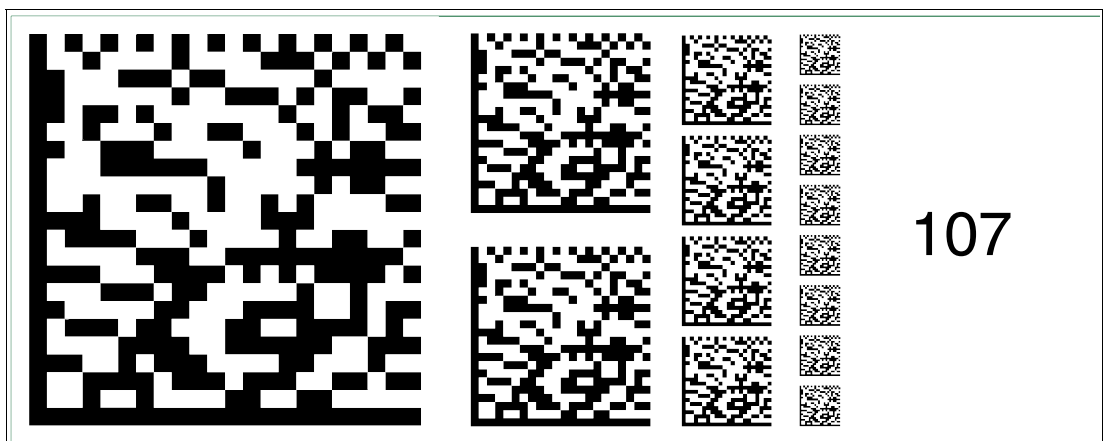

Figure 6.123 The code card "Fieldbus address 107" assigns the fieldbus address 107 to the device.

**Fieldbus address 108**

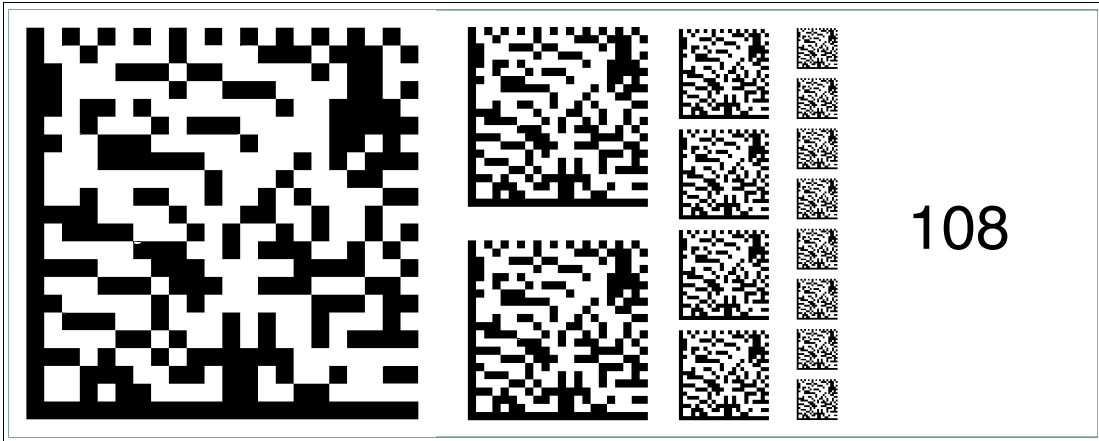

Figure 6.124 The code card "Fieldbus address 108" assigns the fieldbus address 108 to the device.

**Fieldbus address 109**

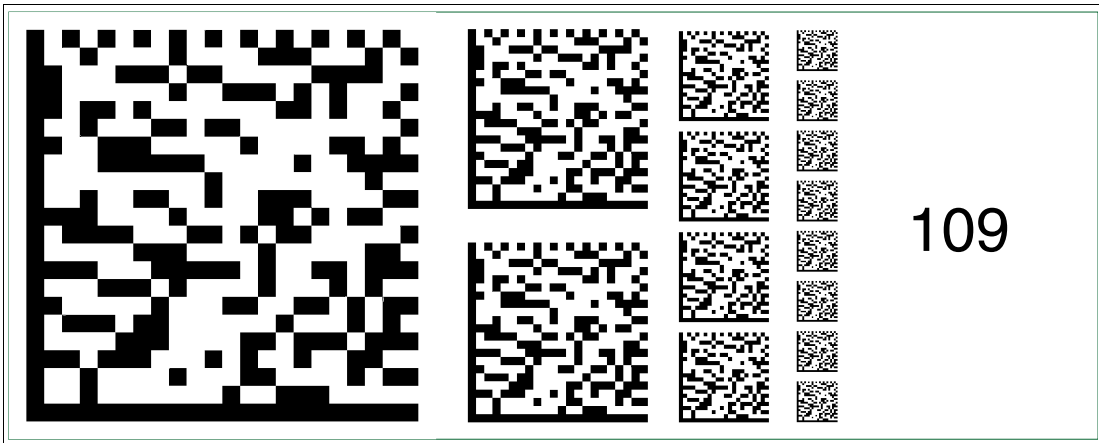

Figure 6.125 The code card "Fieldbus address 109" assigns the fieldbus address 109 to the device.

**Fieldbus address 110**

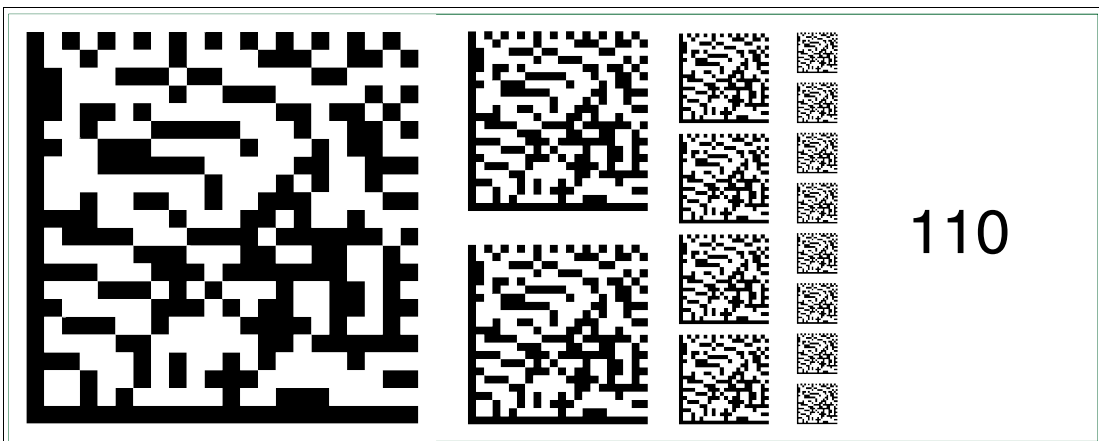

Figure 6.126 The code card "Fieldbus address 110" assigns the fieldbus address 110 to the device.

**Fieldbus address 111**

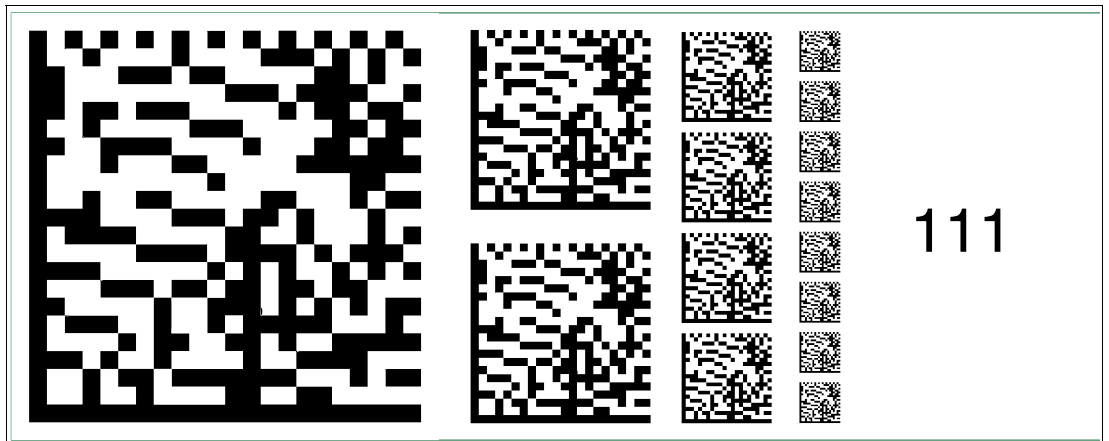

Figure 6.127 The code card "Fieldbus address 111" assigns the fieldbus address 111 to the device.

**Fieldbus address 112**

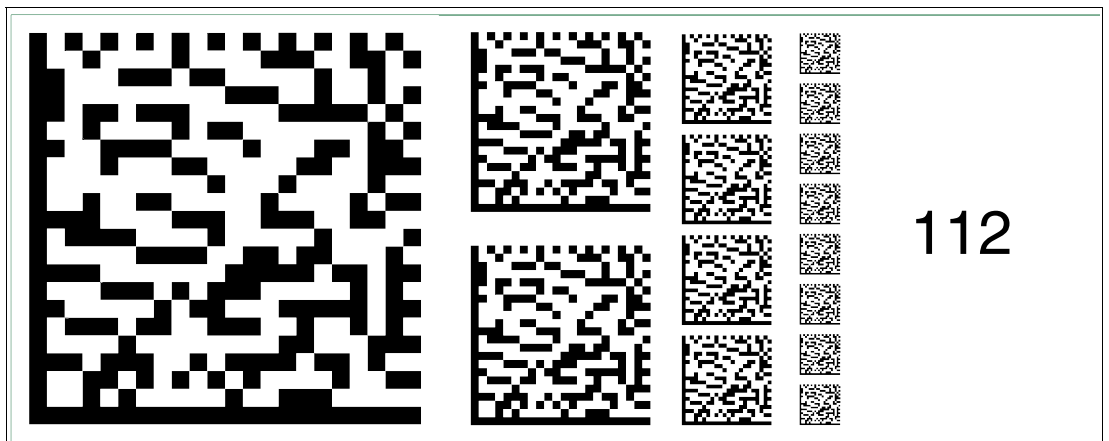

Figure 6.128 The code card "Fieldbus address 112" assigns the fieldbus address 112 to the device.

**Fieldbus address 113**

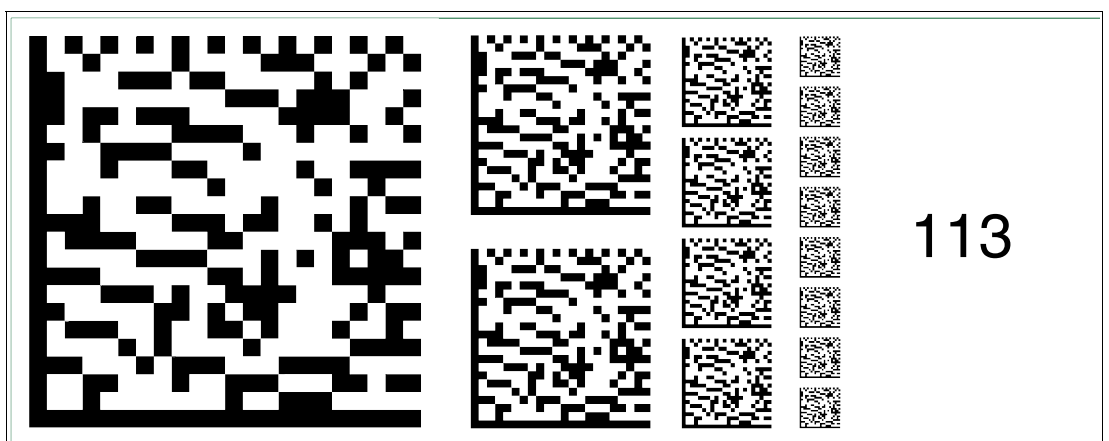

Figure 6.129 The code card "Fieldbus address 113" assigns the fieldbus address 113 to the device.

**Fieldbus address 114**

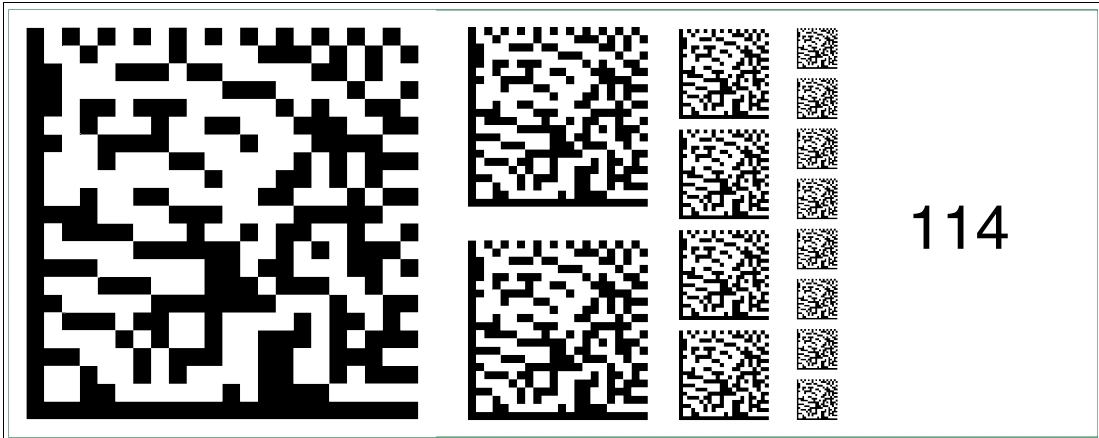

Figure 6.130 The code card "Fieldbus address 114" assigns the fieldbus address 114 to the device.

**Fieldbus address 115**

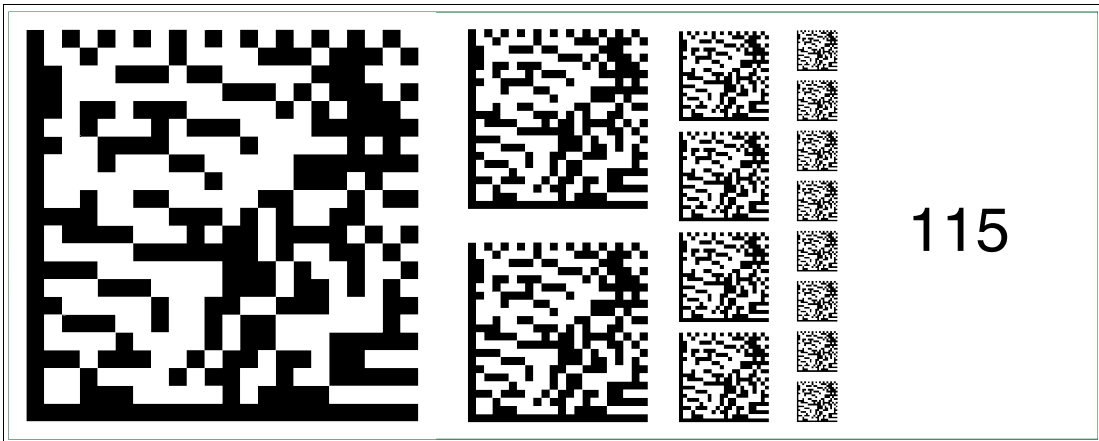

Figure 6.131 The code card "Fieldbus address 115" assigns the fieldbus address 115 to the device.

**Fieldbus address 116**

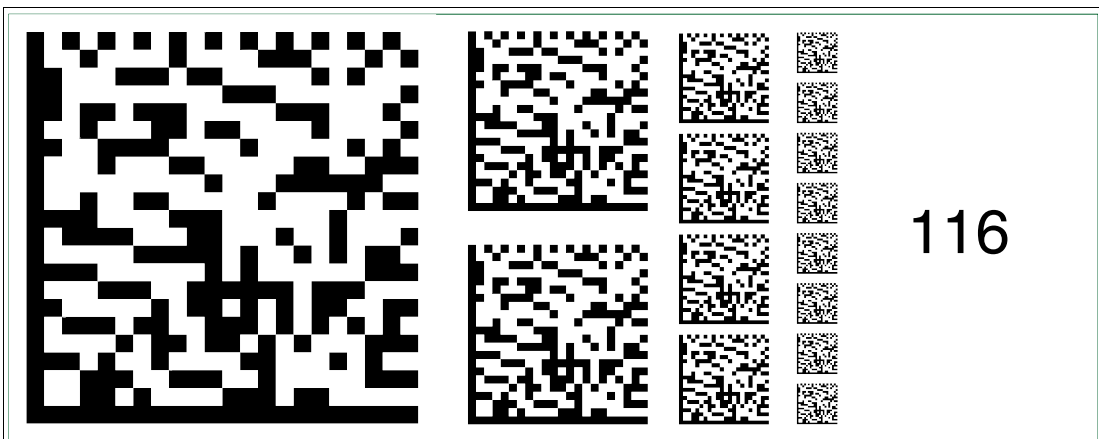

Figure 6.132 The code card "Fieldbus address 116" assigns the fieldbus address 116 to the device.



**Fieldbus address 117**

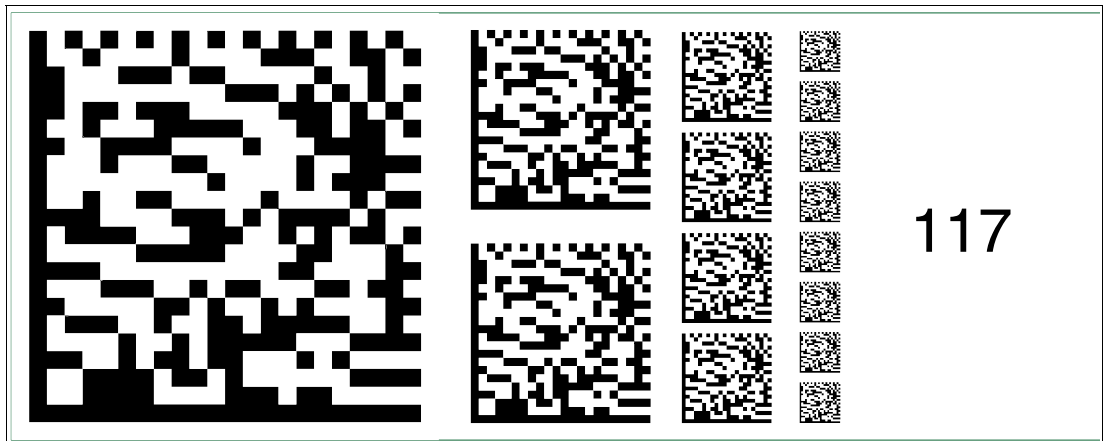

Figure 6.133 The code card "Fieldbus address 117" assigns the fieldbus address 117 to the device.

**Fieldbus address 118**

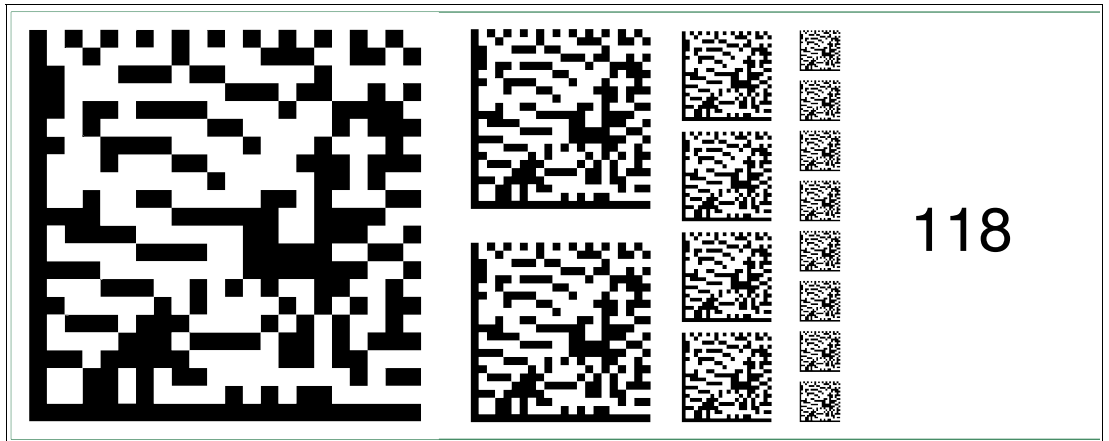

Figure 6.134 The code card "Fieldbus address 118" assigns the fieldbus address 118 to the device.

**Fieldbus address 119**

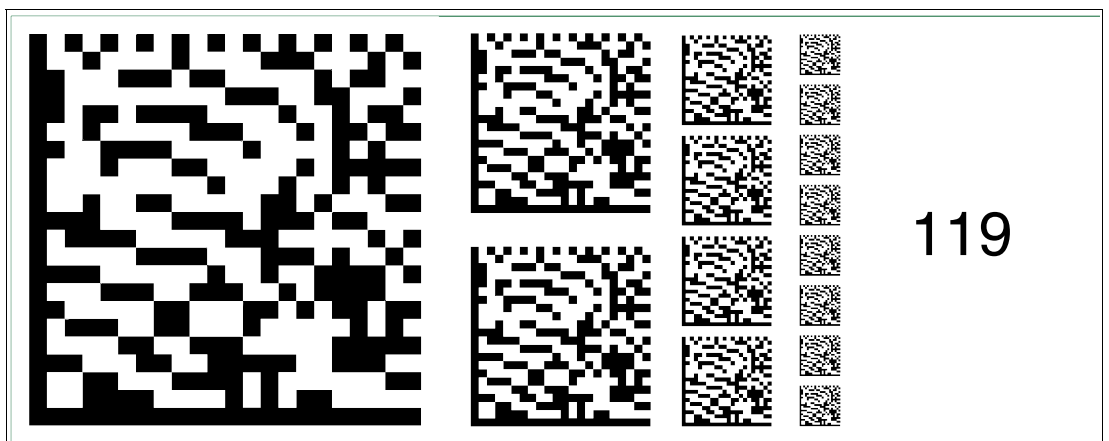

Figure 6.135 The code card "Fieldbus address 119" assigns the fieldbus address 119 to the device.

**Fieldbus address 120**

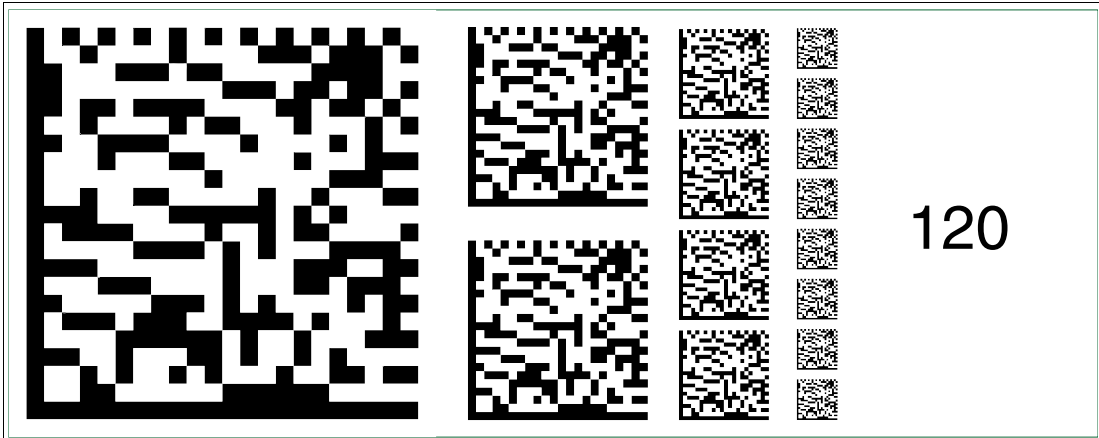

Figure 6.136 The code card "Fieldbus address 120" assigns the fieldbus address 120 to the device.

**Fieldbus address 121**

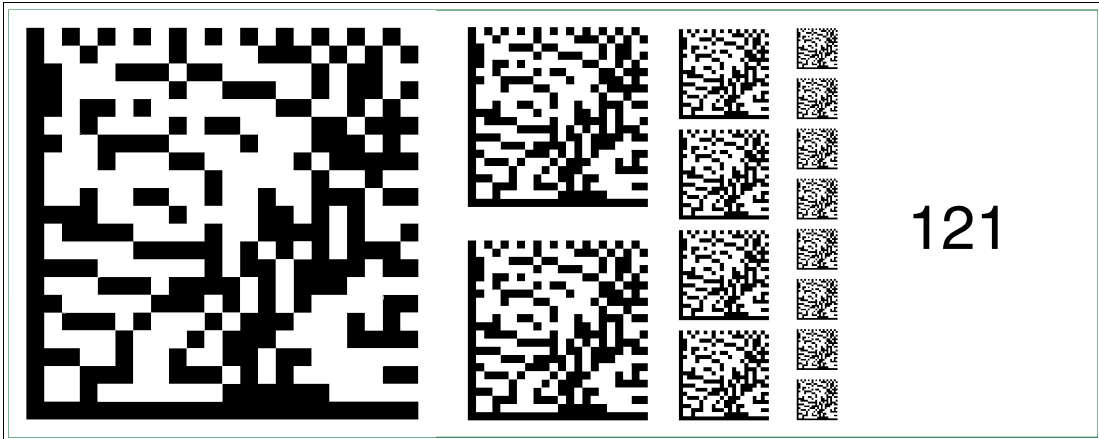

Figure 6.137 The code card "Fieldbus address 121" assigns the fieldbus address 121 to the device.

**Fieldbus address 122**



Figure 6.138 The code card "Fieldbus address 122" assigns the fieldbus address 122 to the device.

**Fieldbus address 123**

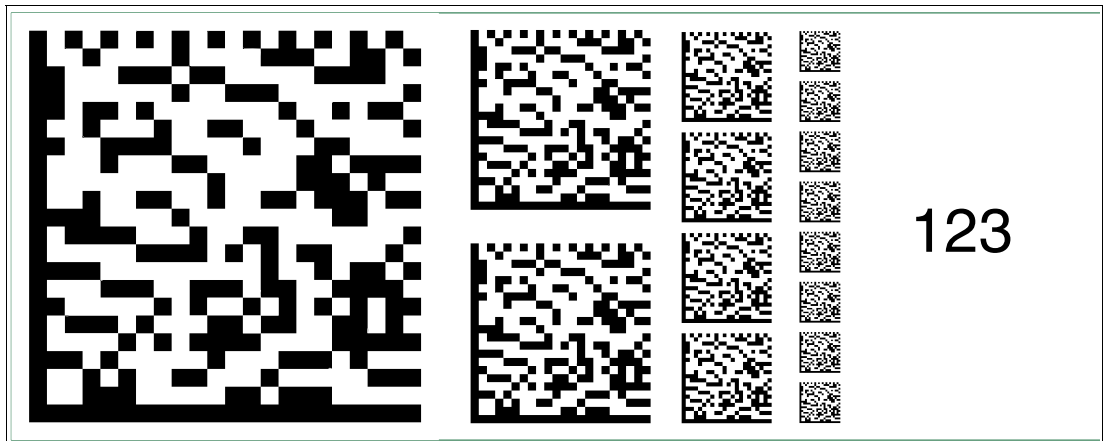

Figure 6.139 The code card "Fieldbus address 123" assigns the fieldbus address 123 to the device.

**Fieldbus address 124**

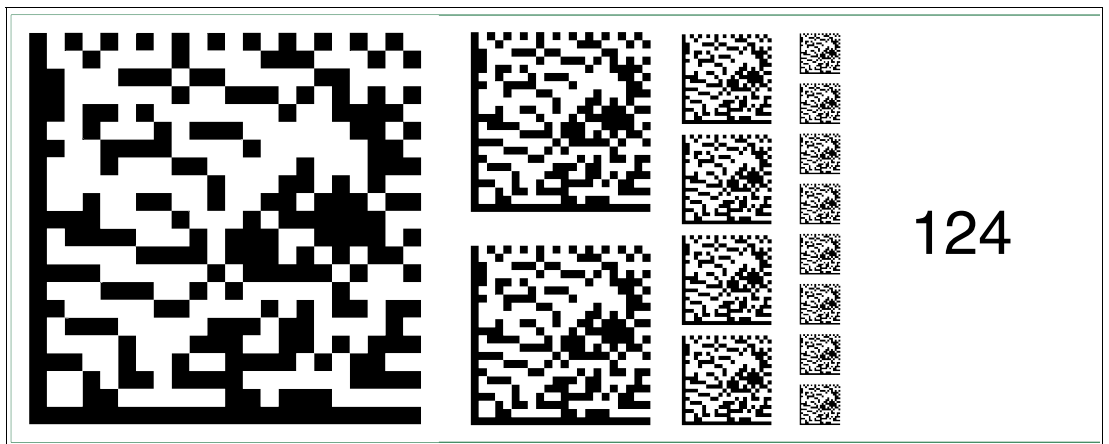

Figure 6.140 The code card "Fieldbus address 124" assigns the fieldbus address 124 to the device.

**Fieldbus address 125**

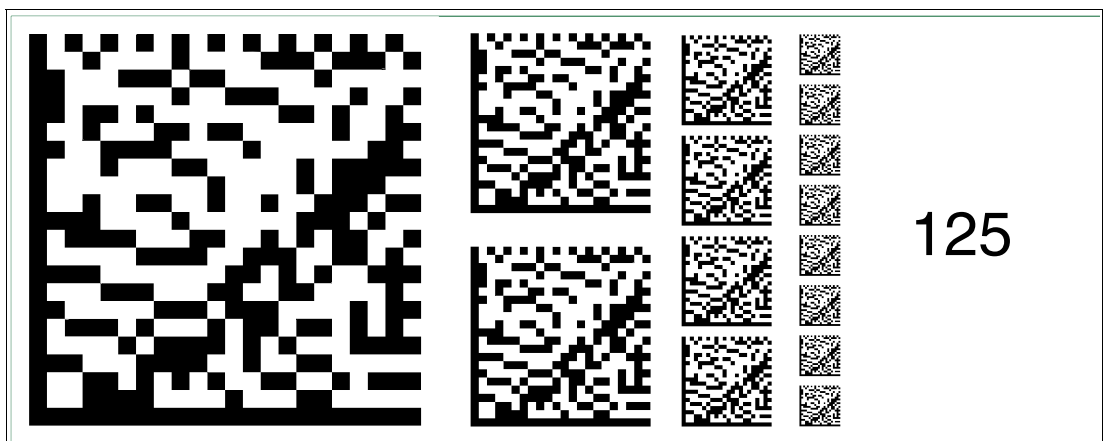

Figure 6.141 The code card "Fieldbus address 125" assigns the fieldbus address 125 to the device.

# Your automation, our passion.

## Explosion Protection

- Intrinsic Safety Barriers
- Signal Conditioners
- FieldConnex® Fieldbus
- Remote I/O Systems
- Electrical Ex Equipment
- Purge and Pressurization
- Industrial HMI
- Mobile Computing and Communications
- HART Interface Solutions
- Surge Protection
- Wireless Solutions
- Level Measurement

## Industrial Sensors

- Proximity Sensors
- Photoelectric Sensors
- Industrial Vision
- Ultrasonic Sensors
- Rotary Encoders
- Positioning Systems
- Inclination and Acceleration Sensors
- Fieldbus Modules
- AS-Interface
- Identification Systems
- Displays and Signal Processing
- Connectivity

### Pepperl+Fuchs Quality

Download our latest policy here:

[www.pepperl-fuchs.com/quality](http://www.pepperl-fuchs.com/quality)

