

Industrial Identification

Product Group Brochure
Optical Identification and RFID



Your automation, our passion.

 **PEPPERL+FUCHS**

Find Your Device in Just a Few Clicks

Go online. Specify your requirements. Select your device. You can find the right solution for your application in just a few clicks. If you have any questions, our experts are available to take your call.

Online Search on the Pepperl+Fuchs Website

Enter the model number in the search field on the Pepperl+Fuchs website and get to your product selection immediately. Model numbers can be found in this brochure in the technical data summaries. Or you can navigate through our range of product families and groups. Product selectors help you select the optimal device.

For example,
"UB100-F77"

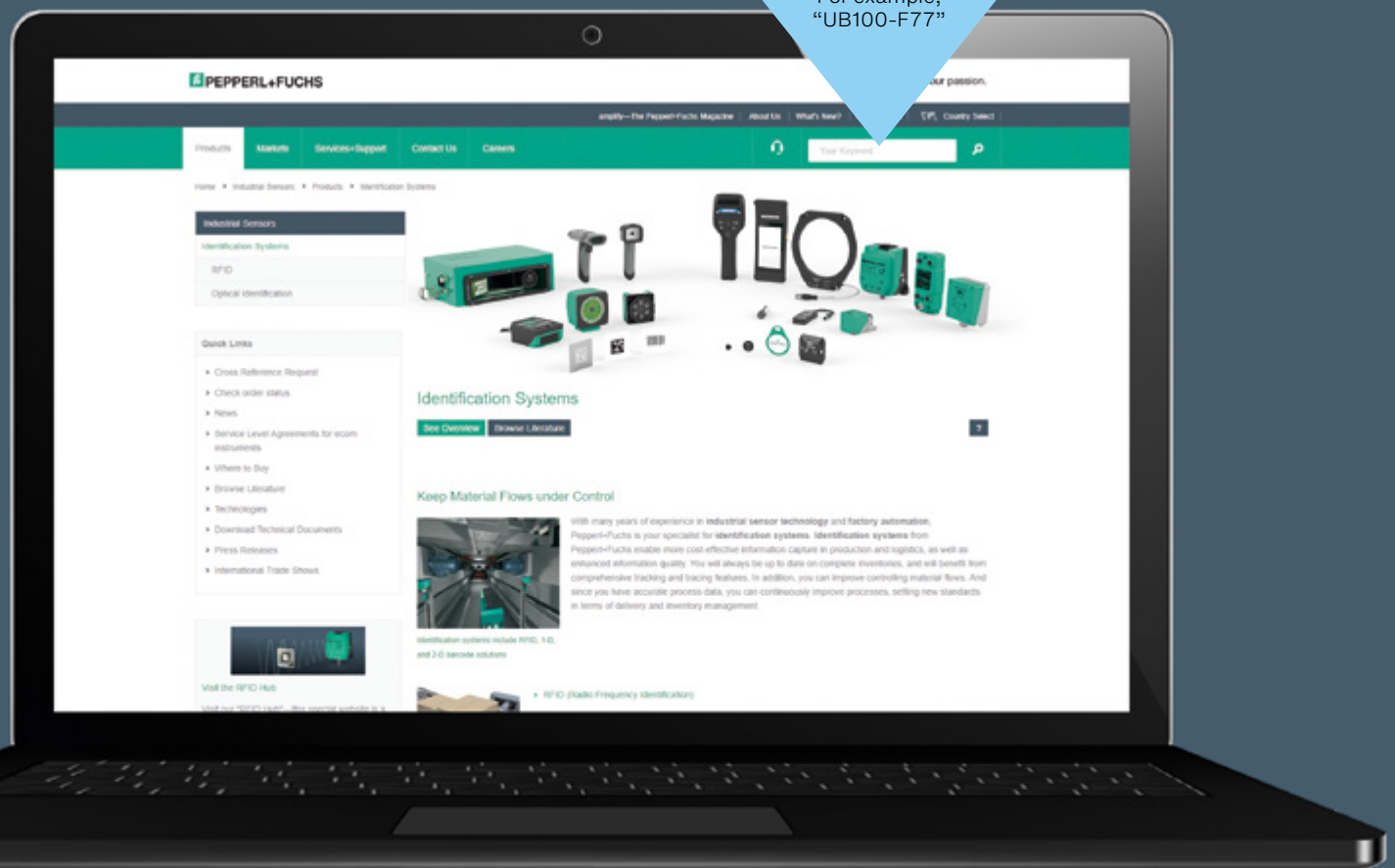

For more information, visit
pepperl-fuchs.com/pf-ident

Contents

Identification Systems from Pepperl+Fuchs	4
Optical Identification—Overview and Technology	6
Stationary 2-D Code Readers	10
2-D Code Handheld Readers	16
Stationary Barcode Scanners	22
OIT High-Temperature Identification Systems	26
RFID—Overview and Technology	28
IDENTControl Control Interfaces	32
IO-Link Master	34
LF Read/Write Devices	36
HF Read/Write Devices	40
UHF Read/Write Devices	44
Tags	50
Modular Handhelds	52
Devices for Hazardous Areas	54

Identification Systems

Two Technologies, One Goal: Process Transparency

Identification systems guarantee reliable, transparent processes and provide the user with a competitive advantage. Depending on your requirements, Pepperl+Fuchs offers camera and RF (radio frequency) systems. Our experts will help you find the perfect identification solution for every scenario.

RFID—Flexible System Solution for End-To-End Process Transparency

RFID (radio frequency identification) is the clear choice if your application demands a great deal of flexibility. Wireless technology makes it possible to read object information and adapt it if necessary. Another key advantage of RFID is that a line of sight between the reader and tag is not required.

Pepperl+Fuchs guarantees the perfect solution for every identification task as a result of years of application expertise and an extensive portfolio of control interfaces, read/write devices, and tags in the standard LF, HF, and UHF frequency ranges.

Optical Identification—Cost-Effective Solution for Track-and-Trace Applications

If you wish to focus on cost-effectiveness, optical identification systems are the best option. Printed and DPM (direct part marked) codes offer a particularly economical solution.

Optical identification systems from Pepperl+Fuchs guarantee strong reading performance and are highly reliable, even in difficult conditions. Whether they are used for stationary or high-speed reading, mobile identification, or in applications with extreme conditions such as high temperature, these powerful devices always provide the most-up-to-date information on your processes.







Optical Identification

The Reliable Solution for Demanding Conditions

Optical identification systems play a significant role in process reliability and availability in factory automation. These cost-effective solutions guarantee a fully reliable read result, even under demanding conditions and at high speeds. Pepperl+Fuchs offers a wide range of mobile and stationary systems for optical identification that cover all standard code symbologies and boast impressive, powerful functions.



For more information, visit
pepperl-fuchs.com/pf-opto-ident

The Efficient Solution for Transparent, Reliable Processes

Optical identification systems from Pepperl+Fuchs are used in almost all areas of industrial automation, helping to improve the transparency and reliability of processes within these industries with lasting results. The systems can be used in any application, be it in challenging ambient conditions, at high scan rates, or in extreme temperatures. The extensive portfolio of stationary readers and handhelds offers the right solution for every identification task, guaranteeing reliability and the highest read quality.

The portfolio of optical identification devices from Pepperl+Fuchs includes various code types and code readers. You will always find the right solution—even for extreme applications.

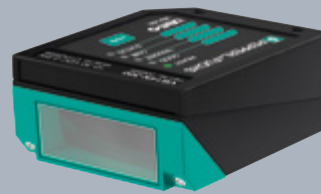

Stationary Barcode Scanners

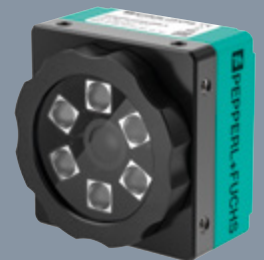

Stationary 2-D Code Readers



Diverse Code Symbolologies

Powerful Systems, Impressive Performance

Track-and-trace applications play a crucial role in modern manufacturing processes. They ensure maximum transparency since they allow all processing steps to be planned, carried out, and tracked. To support these tasks, Pepperl+Fuchs offers an extensive portfolio of stationary and mobile sensors that are suitable for all standard 1-D and 2-D codes. These powerful devices are quick to integrate and simple to commission, and they can be perfectly adapted to the individual application requirements of the customer.

The Right Code for Every Application

Optical identification applications are just as diverse as the codes used in them. These codes can be found printed, laser-etched, or stamped onto various surfaces, which include shiny, reflective, and metallic materials. Despite their numerous differences, the one thing that all codes have in common is the crucial track-and-trace information that they store throughout the entire production or machining process. This data must be read securely and reliably, regardless of whether the data is written on the material itself (DPM) or a stamped code sheet is used at ambient temperatures of up to 500 °C. To assist with these tasks, Pepperl+Fuchs offers a variety of code readers for optical identification, all of which perform well, even in extreme conditions.



2-D Code Handheld Readers



Special Solutions

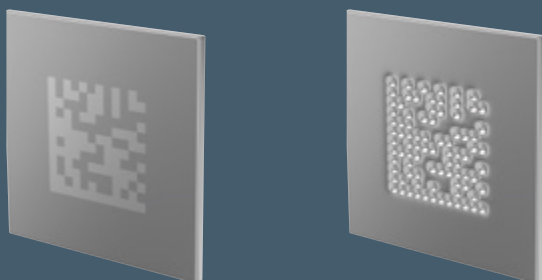

Special Code Sheets

VOS Ident—Universal with Ultimate Reliability

Whether stationary or at high speeds, printed or directly marked codes, large distances or minimum code sizes—the tasks taken on by code readers in factory automation are enormously varied. The sum of its powerful features and customization options makes the VOS Ident series a universal solution for the most demanding of application requirements.



A Code Reader for All Applications

As a truly universal genius, the VOS Ident boasts numerous functions and customization options. The devices are reliable at reading all standard 1-D or 2-D codes (including laser-inscribed/needle-punched DPM and match codes). For total efficiency, multiple reading windows can be created via a multiwindow, and up to 64 codes can be detected in each window using a multicode function. Multiple sensors can also be combined depending on the application requirements. All devices allow convenient remote access and storage of up to 32 jobs. Images can be stored on the sensor and the FTP server. The Vision Configurator can be used to customize the output string and integrate it into the system. The device inputs and outputs also offer flexible definition options.

VOS Ident is part of the comprehensive, universal VOS vision sensor series. The series offers identification and text recognition (OCR) and additional vision tools to perform typical tasks of optical measurement, positioning and guidance, and detection and calibration.

Typical Applications

- Automotive industry: track-and-trace applications (and direct part marking)
- Warehousing and material handling: code reading on boxes and trays
- Semiconductor industry: control of SMD placement

Highlights

- Large distance and sensing ranges
- Multifunctional: parameterization of up to 32 jobs, match code, multicode, multiwindow, and multisensor mode, output string formatting, and code quality output
- Customized hardware and software as required
- Interfaces: Ethernet TCP/IP, PROFINET IO, EtherNet/IP, RS 232, and I/Os
- Code quality output according to ISO 15415, ISO 16022, ISO/IEC TR 29158 (AIM DPM)
- Emulator for offline testing and parameter optimization
- Extensive range of external lighting options and lenses



Powerful and Highly Adaptable

The new VOS2000-I boasts a high resolution of 1.2 megapixels, white internal illumination, and several lens versions for detecting large and small fields of view. It is therefore possible to read even the smallest codes of just 0.1 millimeters and from a distance of up to one meter. Mechanical rotation allows the focus range to be adjusted conveniently to the required distance.



C-Mount Versions: Added Flexibility

The VOS2000-I and VOS5000-I code readers are also available as C-mount versions. In addition to the lens, the lighting can be selected to suit the application requirements, ensuring superior flexibility. The lighting is attached to and controlled by the code reader—no additional voltage supply is required. The VOS5000-I covers an extremely broad scanning range using its resolution of 5.2 megapixels and reads even the smallest codes with absolute reliability.

Excerpt of technical data	VOS2000-F226W-8MM-I	VOS2000-F226W-16MM-I	VOS2000-F226-C-I	VOS5000-F227-C-I
Hardware	1.2 megapixels, white LED lighting		1.2 megapixels, C-mount lens cap	5.2 megapixels, C-mount lens cap
Read range	Max. 355 mm × 266 mm (1-D: 0.48 mm bar width; 2-D: 0.64 mm module size)	Max. 295 mm × 221 mm (1-D: 0.4 mm bar width; 2-D: 0.54 mm module size)	Max. 376 mm × 282 mm (1-D: 0.5 mm bar width); max. 278 × 208 mm (2-D: 0.5 mm module size)	Max. 752 mm × 602 mm (1-D: 0.5 mm bar width); max. 556 mm × 445 mm (2-D 0.5 mm module size)
Read distance	Max. 600 mm	Max. 1,000 mm	Max. 2,000 mm (with external lighting)	
Readings per second	Max. 30 Hz			Max. 25 Hz
Object speed	Max. 4 m/s			
Min. module size	0.1 mm			
Code symbologies	1-D: BC412, Codabar, Code 11, Code 32, Code 39, Code 128, EAN-8/13, DataBar, Interleaved 2 of 5, MSI Plessey, Pharmacode, Plessey, Telepen, UPC-A/E, Postcode, Trioptic 2-D: Aztec-Code, DataMatrix-Code, Dotcode, Grid Matrix, Han Xin Code, Maxi Code, Micro PDF417, Micro QR Code, PDF417, QR Code			

Powerful Features to Satisfy Every Application Requirement

Identification tasks in factory automation are as demanding as they are different. The VOS Ident boasts a huge range of customization options to offer the right solution for every individual application requirement. The intuitive user interface is synonymous with optimal workflows and simple operation.



Reliable Reading of DPM Codes

The VOS Ident is perfectly tailored to the requirements of the automotive industry. The devices here easily read needle-punched and laser-inscribed codes from a distance of up to two meters. A decoder specialized in DPM reading ensures reliable reading of codes at all times, even with difficult conditions such as reading shiny components.

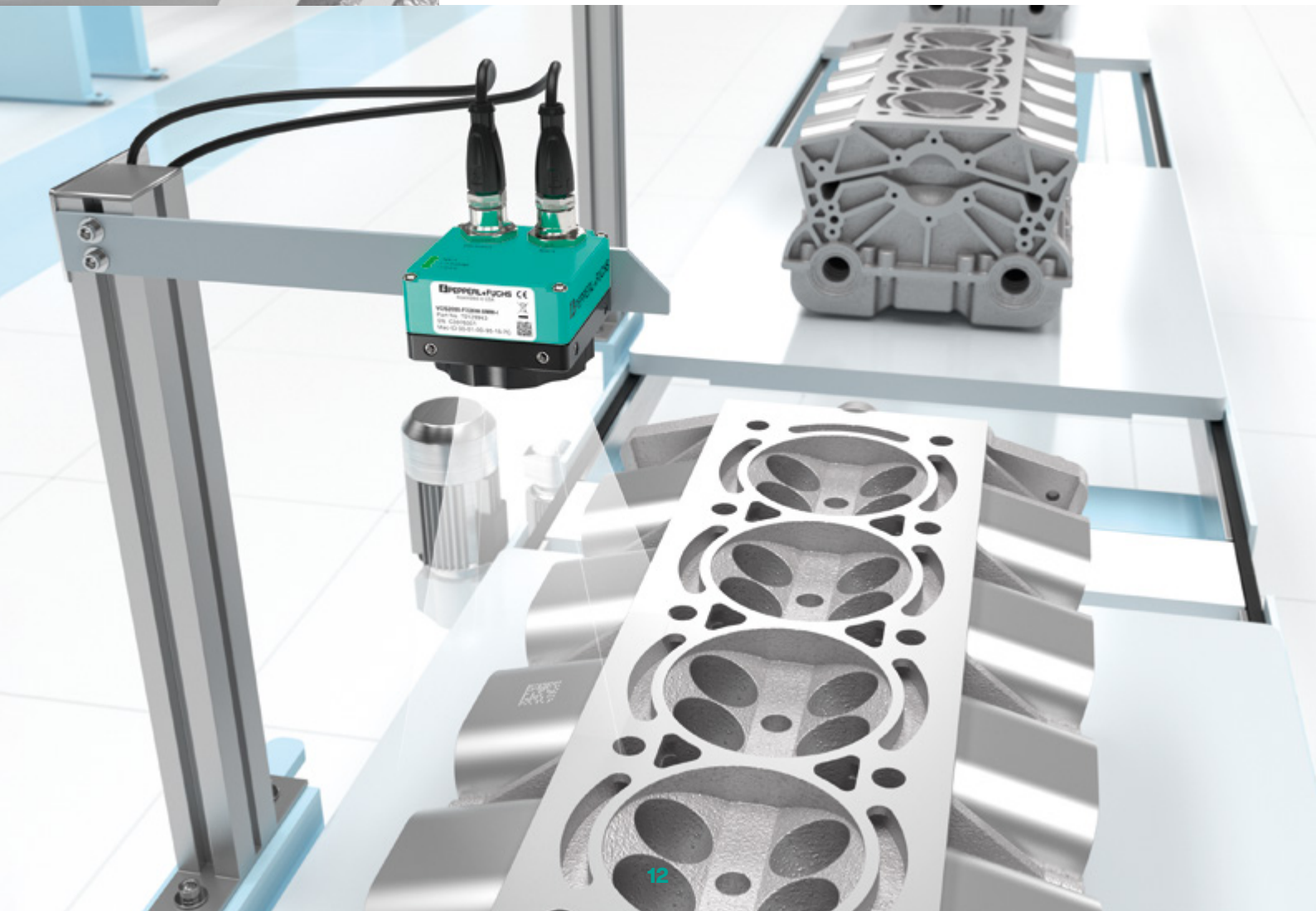

Multipage Reading and Large Scanning Ranges

The VOS Ident is perfectly suited for demanding applications in warehousing and material handling. The large scanning range ensures that reliable code reading on cartons and tablets is ensured both when stationary and at high speeds. Multiple devices are very easily connected together to realize multipage reading. Secure code reading in a broad scanning range can be guaranteed due to the high resolution and multisensor combinations.

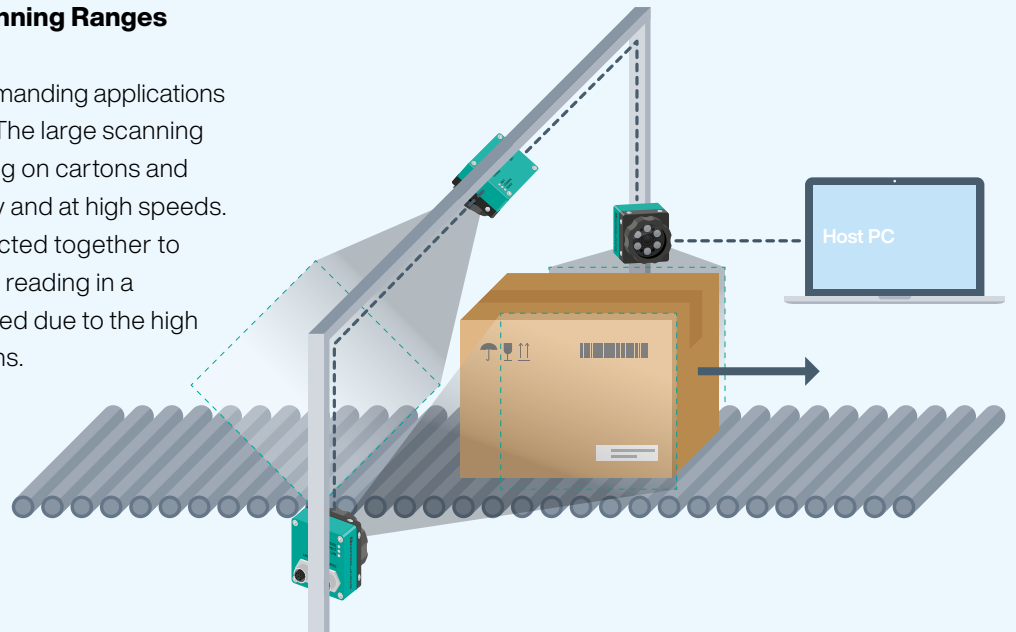

Multicode Reading and Detection of the Smallest Codes

In the field of electronics manufacturing, the printed circuit boards contain different types of codes in different positions. The VOS Ident offers the option of detecting up to 64 codes in a single reading window. It is also reliable at reading extremely small codes of a module size of up to 0.1 millimeters.

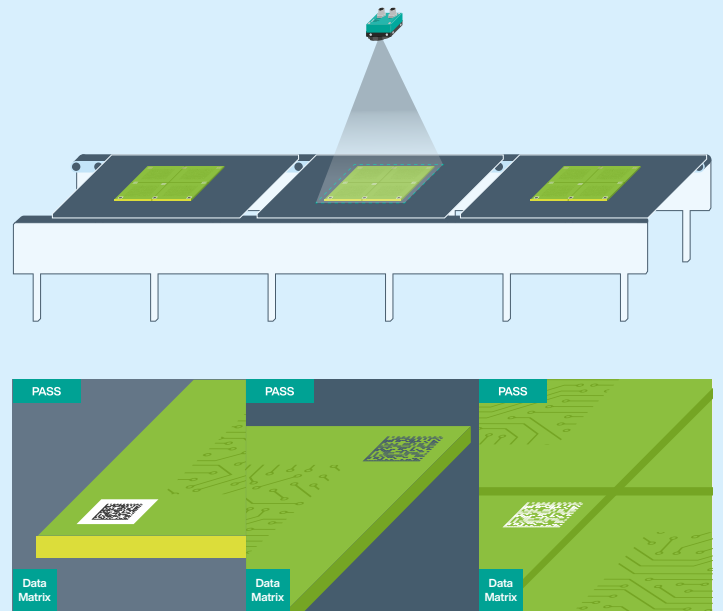

Flexible Output String Formatting through Powerful Script Functionality

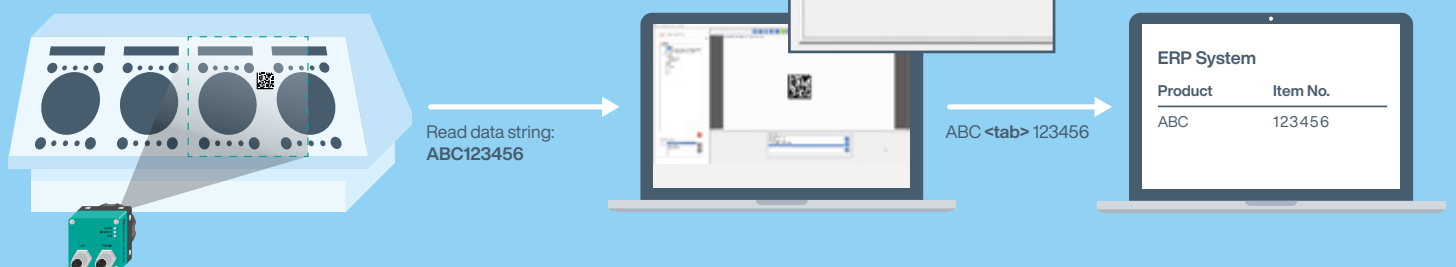

OPC—High-Speed Code Reader for the Print and Paper Industry

Simple operation and high-speed code reading: the high-performance OPC device series is precisely tailored to the particular requirements of the print and paper industry.



Optimal Read Quality, Incredible User-Friendliness

Whether reading standard 1-D and 2-D codes or reading at high speeds, the stationary readers in the OPC120 series are true performance artists, covering the entire range of demanding applications perfectly. Even in the most challenging conditions, these readers provide value thanks to their high performance, both when stationary and at high speeds. Features such as print presence detection, logo comparison, and multiwindow with up to four windows ensure ultimate efficiency and reliability in the reading process. In addition, the devices offer perfect operating comfort and an automatic error image memory. The OPC 120 was optimized to meet the particular requirements of the print and paper industry. The outstanding reading performance—especially on reflective surfaces—qualifies the device for a variety of other code-reading tasks at close range.

Typical Applications in the Print and Paper Industry

- Print presence detection
- Logo comparison
- Code reading

Highlights

- Reliable 1-D / 2-D code reading at close range
- High-speed code reading of up to 10 m/s at 100 readings per second
- Intelligent functions such as print presence detection, logo comparison, and multiwindow
- Reliable reading on highly reflective surfaces using polarization filter technology

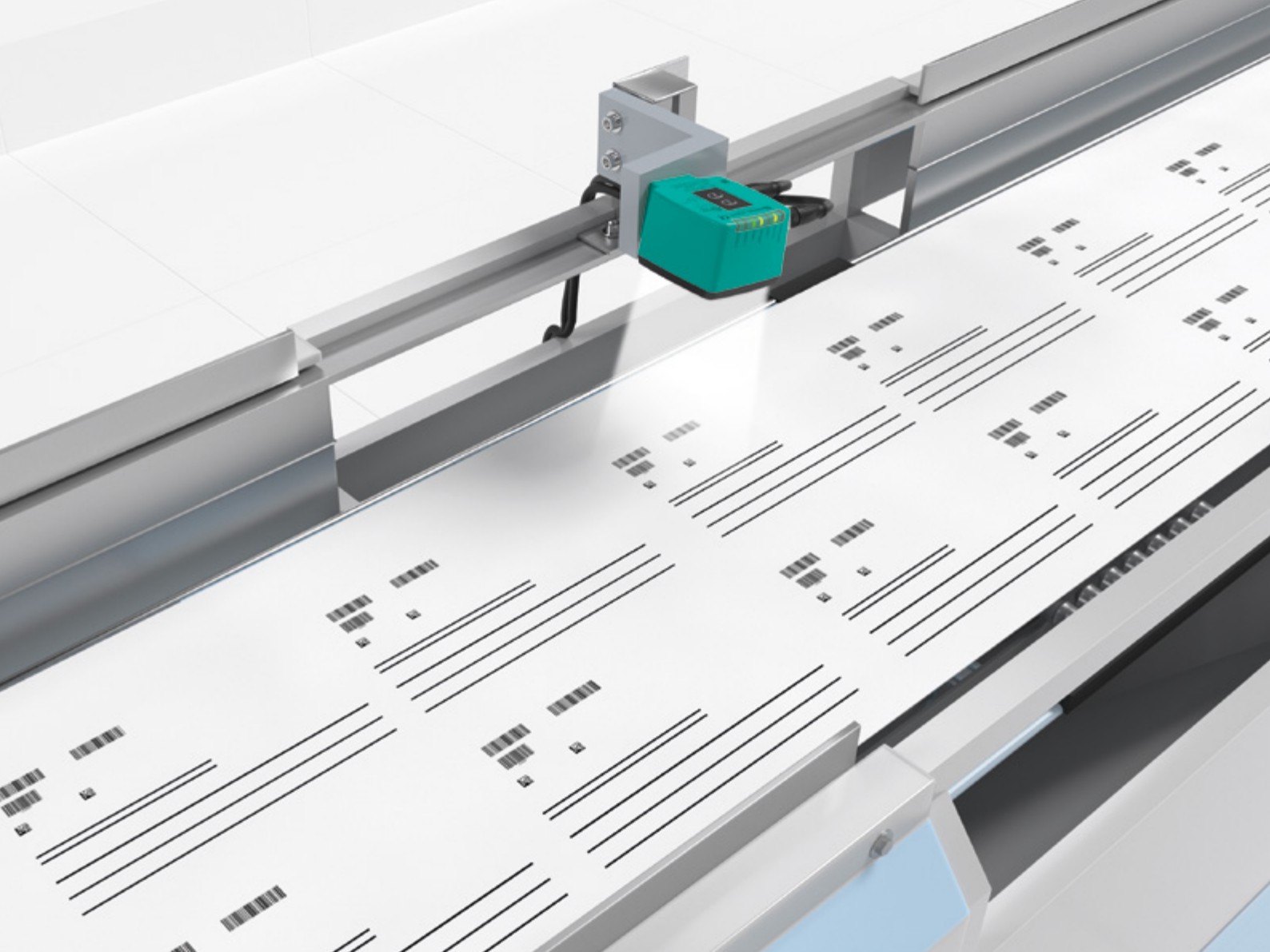

Excerpt of technical data

	OPC120W-F200-R2	OPC70P-F201-R2-45	OPC120P-F201-R2	OPC120P-F201-B17
Read field	Max. 105 × 65 mm	Max. 35 × 55 mm	Max. 105 × 65 mm	
Read distance	70 mm to 180 mm	45 mm to 90 mm	70 mm to 180 mm	
Object speed	6 m/s	10 m/s		
Special equipment	–	Polarization filter technology		
Code symbologies	Code 128, Code 39, DataMatrix-Code, EAN13, Int 2 of 5, Pharmacode			DataMatrix
Min. module size	0.2 mm	0.15 mm	0.2 mm	0.2 mm
Interfaces	Ethernet TCP/IP, RS232, I/Os			PROFINET
Degree of protection	IP67			

Intelligent Solution for Mobile Identification

Handheld readers from Pepperl+Fuchs offer the perfect solution for every mobile identification application. Individual programming options allow the device to be perfectly adapted to the customer's application, while intelligent features ensure outstanding read quality, even on extremely challenging surfaces.



Easy to Use, Best Read Performance

OHV series' handheld readers provide read performance, ease of use, and adaptability to customer-specific requirements. The devices are capable of reading 1-D and 2-D codes with a high level of reliability, even on reflective surfaces, and cover all standard code symbologies on the market. A patented dual lens allows codes of various sizes to be read using just one setting. To ensure maximum process reliability, each read operation is confirmed by acoustic, tactile, and visual feedback.

Various programming options allow the device to be adapted to individual applications in the most effective way via control codes on the device itself, via the Vision Configurator graphical user interface, or via JavaScript. This means that the handheld readers from Pepperl+Fuchs offer perfect solutions for any mobile identification application.

Typical Applications

Mobile identification tasks in major industries such as the mechanical engineering, automotive, packaging, warehousing, and material handling industries, including:

- Warehouse management: data collection in ERP systems and inventory applications
- Code reading on pharmacy labels, job routing, photo books, etc.
- Identification at manual workstations
- Electronics industry: code reading on PCBs

Highlights of the OHV Series

- Reliable 1-D/2-D code reading on reflective surfaces
- Application flexibility thanks to a sturdy housing and IP65 rating
- High process reliability through user feedback (acoustic, tactile, and visual signals)
- Can be programmed individually for specific application requirements

PROFINET Gateway for Connecting the OHV Series

The compact gateway (OHV-F230-B17) is the ideal solution for the cost-effective connection of handheld readers to the control panel. The gateway is equipped with a PROFINET interface with a built-in switch and is particularly easy to integrate via a standardized M12 plug. An LED status display for communication monitoring, inputs, and outputs makes operating the device simple.



The Portfolio at a Glance



OHV10—Basic Handheld Reader for Many Applications

The wired OHV is the ideal choice for reading all standard 1-D and 2-D codes. The compact handheld reader can be easily programmed using control codes. Stationary operation in a fixture ensures ultimate efficiency in workflows. To do this, the automatic motion detection of the handheld reader is enabled, and the reader automatically reads the codes with superior reliability as they pass by.



OHV110—Compact Solution for Demanding Tasks

The wired OHV110 is a compact handheld reader that detects 1-D and 2-D codes. The patented dual lens and extremely high resolution of 1.2 megapixels mean that very small codes of 0.1 millimeters are detected as reliably as long barcodes. The device can be adjusted very conveniently using control codes and the Vision Configurator user interface. The read results can be written directly into the appropriate fields of ERP systems via flexible output string formatting. JavaScript allows additional, individual customizations to be programmed. The OHV110 offers users the highest read performance and detects a variety of code symbologies. To ensure ultimate efficiency during your workflow, the handheld reader can also be used in a fixture for stationary applications. Automatic motion detection is enabled, and the reader reads the codes automatically as they pass by.



OHV1000—Ideal for Reading DPM Codes

The OHV1000 is a wired handheld reader for detecting DPM codes (needle-punched or laser-inscribed) and printed 1-D or 2-D codes. Paired with a high resolution of 1.2 megapixels, the patented dual lens allows extremely small DPM codes of 0.1 millimeters to be read with the same level of reliability as long barcodes. The handheld reader is extremely easy to adjust via control codes and the user interface. Flexible output string formatting is also possible, which allows read results to be written directly into the appropriate fields of ERP systems. Additional, individual customizations can be conveniently programmed using JavaScript.



OHV210—Mobile Devices for Indoor and Outdoor Applications

The wireless handheld readers reliably detect all common 1-D/2-D codes. The patented dual lens and high resolution of 1.2 megapixels mean that the devices can read very small codes of 0.1 millimeters as reliably as long barcodes. The associated charger has a Bluetooth modem for automatic data transfer. The OHV210 features replaceable batteries and is suitable for indoor and outdoor applications thanks to IP65 protection. The charge status of the batteries can be conveniently displayed at the touch of a button. The OHV210 is perfectly suited for picking tasks since it can be used on the move and automatically reads codes through the charger's reading window.

Excerpt of technical data	OHV10-F228-R2	OHV110-F228-R2	OHV1000-F223-R2	OHV210-F229-B15
Code symbologies	1-D: Codabar, Code 11, Code 32, Code 39, Code 93, Code 128, IATA 2 of 5, Interleaved 2 of 5, GS1 DataBar (RSS), Hong Kong 2 of 5, Matrix 2 of 5, MSI Plessey, NEC 2 of 5, Pharmacode, Plessey, Straight 2 of 5, Telepen, Trioptic, UPC/EAN/JAN Stacked 1-D: Codablock F, Micro PDF, PDF417, GS1 Composite (CC-A/CC-B/CC-C) 2-D: Aztec Code, Data Matrix code, Han Xin Code, Maxi Code, Micro QR code, QR code Zip codes: Australia Post, Intelligent Mail, Japan Post Group, KIX Code, Korea Post, Planet, Postnet, Royal Mail Group Ltd, UPU ID tags			
Depth of field	0.2 mm	0.1 mm		
Read distance	40 mm to 310 mm		0 mm to 200 mm	40 mm to 310 mm
Interfaces	USB, RS-232			Bluetooth, USB (via charger)

A Powerful Tool for Logistics

In the logistics sector, reliably detecting different codes is crucial for smooth processes. The OHV series from Pepperl+Fuchs offers a range of powerful handheld readers that can be used indoors and outdoors.

Flexibility for Picking Processes

OHV210 series' compact handheld readers from Pepperl+Fuchs are perfectly suited for use at the reading point. Due to the dual lens and a resolution of 1.2 million pixels, it is possible to read large and small codes at various distances. At the same time, the target projection makes it easier to see the codes, and the reading feedback is communicated clearly through vibration, an LED display, and an audible signal.

The handheld reader's charger offers specific advantages for picking processes—for example, when the device is plugged

into the charger, the motion detection mode is activated automatically. This allows users to simply place packages with codes on them under the charger; the handheld reader automatically reads the codes through the charger's reading window. To read codes at a different location, users can remove the device from the charger and start mobile reading.

For the purpose of integrating the devices into ERP systems, the Vision Configurator software can be used to create rule sets for formatting read results—without any programming. The data read is transmitted via Bluetooth. This enables direct data transfer to smartphones and tablets.



Extra Flexibility

The OHV series of 2-D code handheld readers can be conveniently adapted to any application using control codes, the Vision Configurator, or JavaScript.

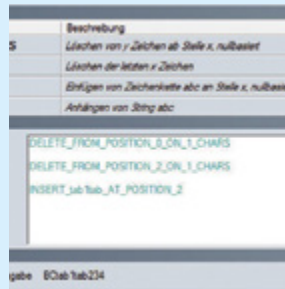

Read data string: ABC1234

BC <tab> 1 <tab> 234

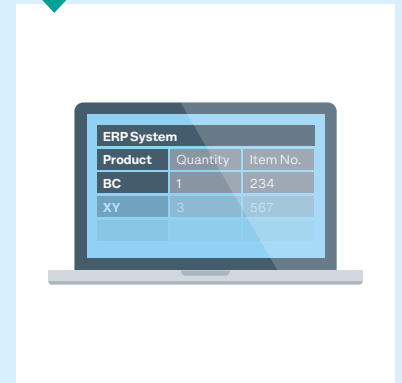
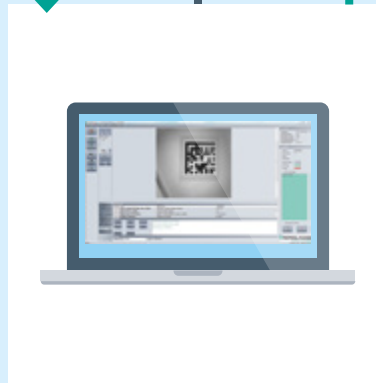

Adjustment of Data String

“Erase Position 1”
“Replace Position 4 with <tab> 1 <tab>”

Output String Formatting

Adjustments to the output string are easy with the Vision Configurator. A read data string can be customized by simple command selection and integrated into ERP systems.

Perfectly Adapted to the Application— It's Easy with Vision Configurator

The Pepperl+Fuchs Vision Configurator enables the configuration of a wide range of parameters at the click of a mouse and the user-friendly customization of the output string. Customizations can be saved on both the handheld reader and the PC. In addition, the Vision Configurator can generate control codes for all customizations.

The software can be found at:
www.pepperl-fuchs.com/pf-vision-configurator

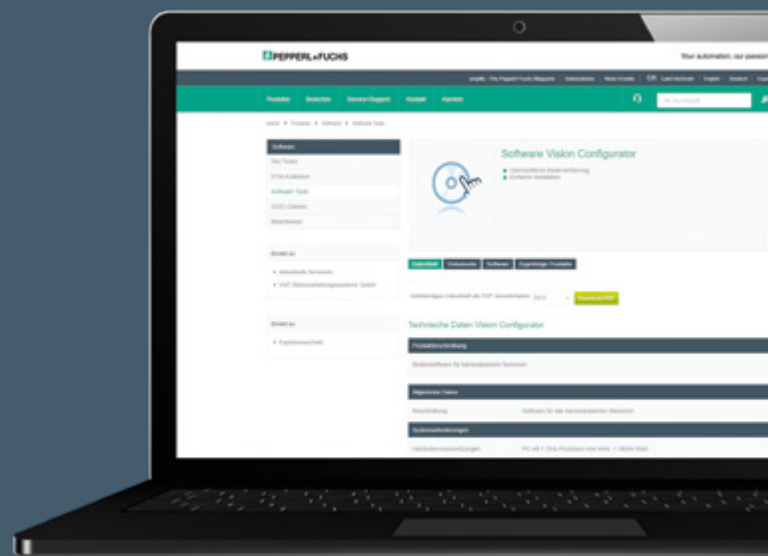

Wide Range of Applications, High Efficiency

The barcode scanners from Pepperl+Fuchs ensure complete process reliability, even at low temperatures, long distances, and extremely high scan rates, meaning that the devices are perfect for covering a wide range of applications. Up to 32 scanners can be networked with one another, and they ensure a high level of efficiency by utilizing every step in the process chain.



From High Speeds to Low Temperatures

Barcodes are now ubiquitous in industry and trade—but when it comes to reading barcodes, every application has its own special requirements. From different sizes and distances, variable speeds, and varying levels of damage, Pepperl+Fuchs has got this vast spectrum of requirements covered with its two extremely powerful reader series. Read distances of up to 2.5 meters, scan rates of up to 1,200 scans per second, and code sizes of just 0.2 millimeters are processed with total accuracy and incredible efficiency. Up to 32 scanners can be networked to form an integrated solution. Reliable process flows and excellent read performance are guaranteed at all times, even at temperatures as low as -35°C .

Various connector boxes are available for connecting the barcode scanners from Pepperl+Fuchs to fieldbus systems. These connector boxes and other accessories can be found online at www.pepperl-fuchs.com.

Typical Applications

- Warehousing and material handling: code reading on boxes, pallets, and trays
- Print and paper industry: code reading in enveloping machines
- Packaging industry: verification and assignment of products to outer packaging
- Automotive industry: odette label reading

Highlights

- Networking of up to 32 scanners
- High scan rates of up to 1,200 scans/second for the fastest processing speeds
- Automatic and programmable focus settings for continuous process flows
- Reliable code reconstruction for reading damaged or rotated barcodes
- Extended temperature range of up to -35°C

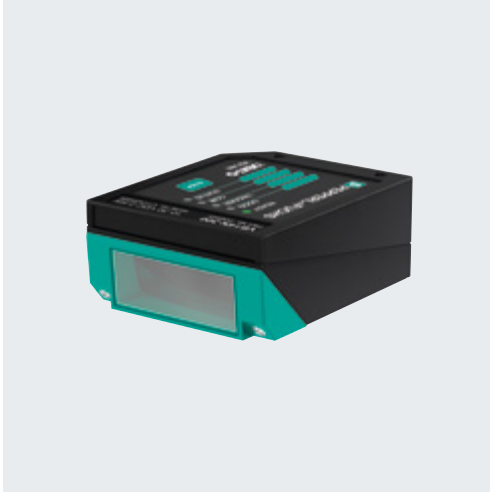

VB14N Series—Ideal Even for Low-Temperature Applications

The compact line scanners for 1-D barcodes offer unmatched read performance, even with difficult contrast ratios. A function key enables easy commissioning of the device and convenient teach-in of the codes. Up to 32 devices can be networked with one another via ID-NET™ to form a complete solution. The VB14N-T version is equipped with an integrated heater that has a quick warm-up phase (max. 20 minutes). This means that the scanner can resist ambient temperatures as low as -35 °C, making it ideal for deep-freeze environments.



VB34 Series—Reliable over Large Distances

The VB34¹ series is optimized for reading codes over distances of up to 2,500 mm. The focus of the optical system can be individually programmed and tailored to specific application requirements, while the integrated code reconstruction for damaged and rotated barcodes significantly increases process reliability. Since the entire scanner unit is mounted in a way that allows for adjustment, the device can be tailored to suit the application as closely as possible. The devices are equipped with various interfaces and are available with an optional oscillating mirror, which means that integrating the devices into existing system environments is quick and seamless.

Excerpt of technical data for the VB14N series	VB14N-300 (-R)	VB14N-600 (-R)	VB14N-400-T (-R)	VB14N-600-T (-R)
Read distance	40 mm to 300 mm	190 mm to 600 mm	60 mm to 400 mm	190 mm to 600 mm
Min. resolution	0.2 mm (8 mils)	0.35 mm (14 mils)	0.2 mm (8 mils)	0.35 mm (14 mils)
Scanning frequency	500 scans/s to 800 scans/s	600 scans/s to 1,000 scans/s		
Interface	R232 and RS485			

Excerpt of technical data for the VB34 series	VB34 linear version	VB34 integrated oscillating mirror version
Order designation serial/PROFIBUS	VB34-2500-(P)	VB34-2500-OM-(P)
Max. read distance	2,500 mm	
Resolution	0.2 mm (8 mils)	
Scanning frequency	600 to 1,200 scans/s (programmable)	
Main interface	RS232, RS485, or PROFIBUS	
Auxiliary interface	RS232	

¹ The VB34 product family is not available for sale in North America.

High Performance at the Lowest Temperatures

The temperature of deep-freeze storage facilities places considerable demands on the sensor technology in barcode scanners. Devices that are typically used in these applications must be able to reliably identify barcodes at all times. The VB14N-T series from Pepperl+Fuchs is specially designed for such an extreme environment, delivering reliable read results at all times at temperatures as low as $-35\text{ }^{\circ}\text{C}$.

Strong Performance in Low-Temperature Applications

In the food industry, end-to-end cold chains play a vital role in ensuring the quality of the product. For this reason, frozen products must never be stored at a temperature greater than $-18\text{ }^{\circ}\text{C}$. Products are transported to cold storage on trays that are marked with barcodes. These codes can be used to easily identify products, allowing them to be transported to the next step in the process chain.

Challenging ambient conditions such as those in the cold chain require scanners that work quickly and with complete accuracy, even at the lowest temperatures. However, the extreme negative temperatures can have a negative impact on the readability of the code itself. To overcome this issue and guarantee short

throughput times as well as minimal fault rates, even codes that are difficult to read must always be quickly and reliably detected. This poses a real challenge for sensor technology.

Tackling this challenge requires highly specialized scanners such as the VB14N-T with an integrated heater, which ensures optimal read results at temperatures from $-35\text{ }^{\circ}\text{C}$ to $+45\text{ }^{\circ}\text{C}$. The short warm-up time of no more than 20 minutes means that the device is ready to use in no time at all, with a reduced maximum energy consumption of 9.6 watts. High-performance optics and code reconstruction guarantee that barcodes that are difficult to detect can be read with total accuracy, while the compact housing design means that the device can be installed in tight spaces.



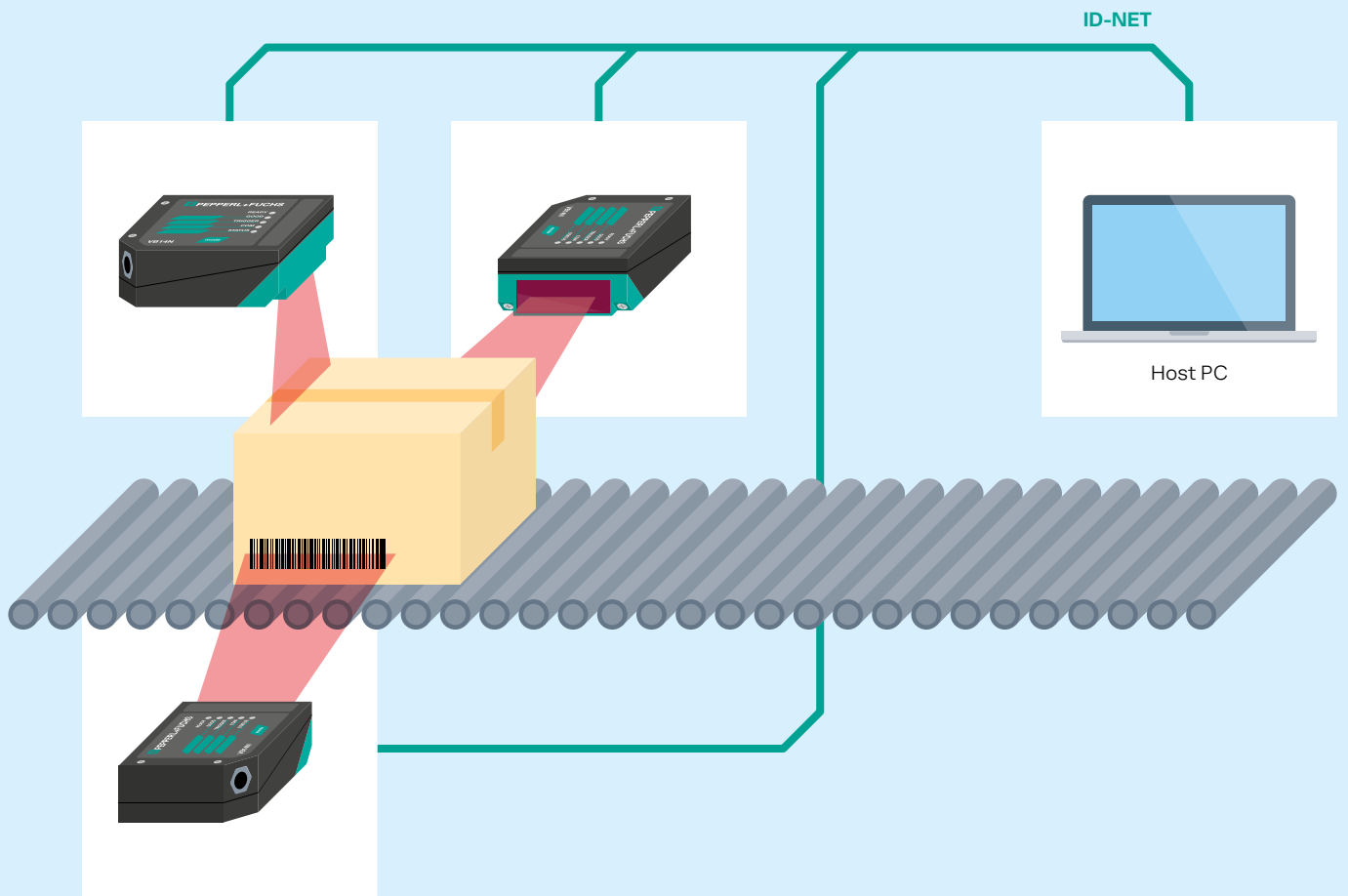

Efficiency through Intelligent Networking

The specially developed data communication system ID-NET allows up to 32 units from the VB14N barcode scanner series to be networked to form one integrated total solution. This allows the highest cycle rates to be achieved, ensuring greater efficiency.

Every System Operates at Peak Performance

Networking the barcode scanners allows for simultaneous detection of multiple barcodes, which might be in different positions on a packaged item. When doing so, the system only occupies one fieldbus address, through which all information flows quickly and efficiently. This enables high cycle rates and supports efficient process flows.

Reliable Code Reading at High Temperatures

Cyclical temperature changes, continuous high temperatures, and the effects of dust and paint place high demands on materials and technology. The durable OIT high-temperature identification system was developed with these demands in mind. The system ensures a reliable read performance and smooth process flow, even at temperatures of up to 500 °C.

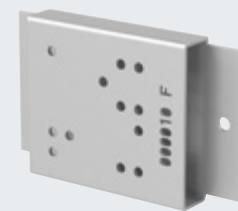

The robust stainless-steel code plates are available in different versions.

Premium Performance at High Temperatures

Drying systems, painting lines, galvanizing plants, and bakeries operate under special production conditions in terms of temperature and pollution. Developed specifically to withstand these extreme conditions, the durable OIT high-temperature identification system from Pepperl+Fuchs ensures smooth process flows in the toughest conditions. Highly reliable read performance is guaranteed, even at temperatures up to 500 °C.

Typical Applications

- Automotive industry: identification in bodysHELL production, painting lines, galvanizing plants, and drying systems
- Color and paint-processing industry: identification tasks
- Bakeries: identification of baking molds

Highlights

- Heat-resistant code sheets for temperatures up to 500 °C
- Reliable identification, even on contaminated code sheets
- Integrated diagnostic function for reliable process flows
- Maintenance-free with the one-piece housing concept; no additional components
- Simple connection to all standard controllers

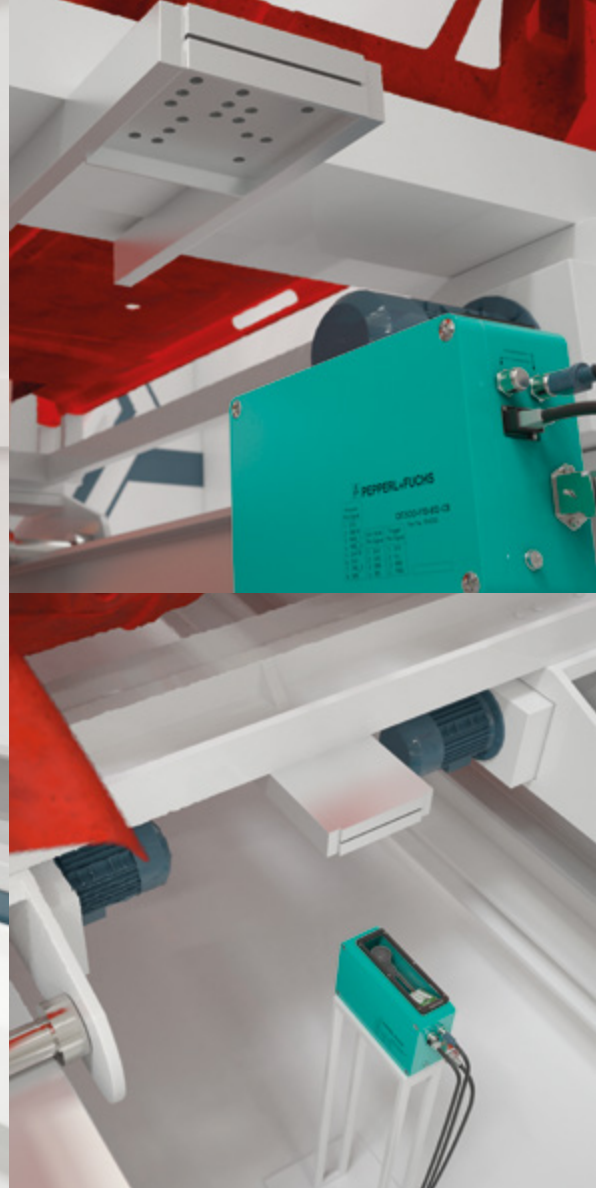

Perfect for Identification at High Temperatures

In drying systems used in automobile construction, parts are subject to the extreme temperatures of curing ovens for the purpose of curing glued joints and drying paint. Heat-resistant code sheets store the necessary information for each vehicle type and must be reliably identified, even if they are contaminated or carry paint residue. High-temperature identification

systems such as the OIT from Pepperl+Fuchs are developed specifically for this purpose, capable of ensuring strong read performance even under the toughest conditions. The devices can be easily integrated into all standard control panels and are maintenance-free thanks to their one-piece housing concept with no additional components.

Excerpt of technical data	OIT500-F113-B12-CB3	OIT500-F113-B17-CB
Read field (max.)	340 mm × 210 mm (at max. read distance)	
Read distance	CB1: 300 mm to 450 mm, CB3: 350 mm to 400 mm	
Interfaces	Ethernet TCP/IP	Ethernet TCP/IP, Profinet IO
Code sheet	CB1: perforated matrix 6 × 6 6 decimal digits 0 bis 999,999 CB3: hole pattern 3 × 12 12 binary digits 1 to 4,095	CB1: perforated matrix 6 × 6 6 decimal digits 0 to 999,999 CB2: perforated matrix 5 × 5 4 decimal digits 1 to 4,095 CB3: hole pattern 3 × 12 12 binary digits 1 to 4,095





RFID

RFID—The Powerful System for the Most Flexibility

Pepperl+Fuchs offers a complete RFID portfolio that consists of perfectly coordinated components. Across all frequency ranges (LF, HF, UHF), our focus remains the same: compatibility and simple operation. Years of expertise and extensive consultation ensure that our RFID system solutions are perfectly optimized to your individual requirements.



For more information, visit
[pepperl-fuchs.com/pf-RFID](https://www.pepperl-fuchs.com/pf-RFID)

Reliability and Transparency for Complex Processes

RFID technology from Pepperl+Fuchs is synonymous with optimized production, high cost efficiency, and the greatest transparency in process flows. Decades of experience and sound application expertise are the foundation for our system solution, which consists of perfectly coordinated components that are tailored to the customer's applications down to the last detail.

Noncontact and Highly Efficient

Radio frequency identification, or RFID, plays a crucial role in automation. The technology uses radio waves to identify objects automatically without making contact. Tags serve as databases transmitting information relating to products, goods, and people, and allowing data and material flows to be combined in the most effective way.

Since tags are used to store all process-relevant information locally on the object, production can be controlled on the basis of the object. Track-and-trace applications allow raw materials and products to be assigned and tracked in a clear manner, while RFID allows process flows to become quicker, more transparent, and much more efficient.

Robust and Durable

RFID tags can handle a lot of mechanical wear. This means that RFID is perfectly suited for harsh environments and extreme temperatures. Other advantages for the process flow include detection without a direct line of sight, even at long distances, and efficient multitag detection with UHF. In addition, the tags can be clearly identified no matter where they are in the world, are resistant to dirt in comparison with barcodes, and offer unlimited read/write cycles.

Innovative Technology for the Smart Factory

RFID is a key technology when it comes to the latest challenges of automation and the factory of the future. As soon as products are equipped with an RFID tag, they are able to carry information relating to necessary production steps and special requirements. This data can be read out at any time.

Once individual production steps are completed, additional information can be added to the tag. This is how RFID brings fresh momentum and considerable flexibility to all areas of production and logistics. For RFID applications, Pepperl+Fuchs offers complete system solutions with IO-Link technology. These solutions enable efficient, reliable communication between the control and sensor levels in line with Industry 4.0.

Highlights

- One-on-one consulting for application-specific system solutions with perfectly coordinated components
- Components for all frequency ranges (LF, HF, and UHF)
- IDENTControl system: simple system integration, compatible with standard control panels
- IO-Link: new application possibilities, transparency down to the field level



For more information on RFID technology, visit www.pepperl-fuchs.com/pf-rfid-hub

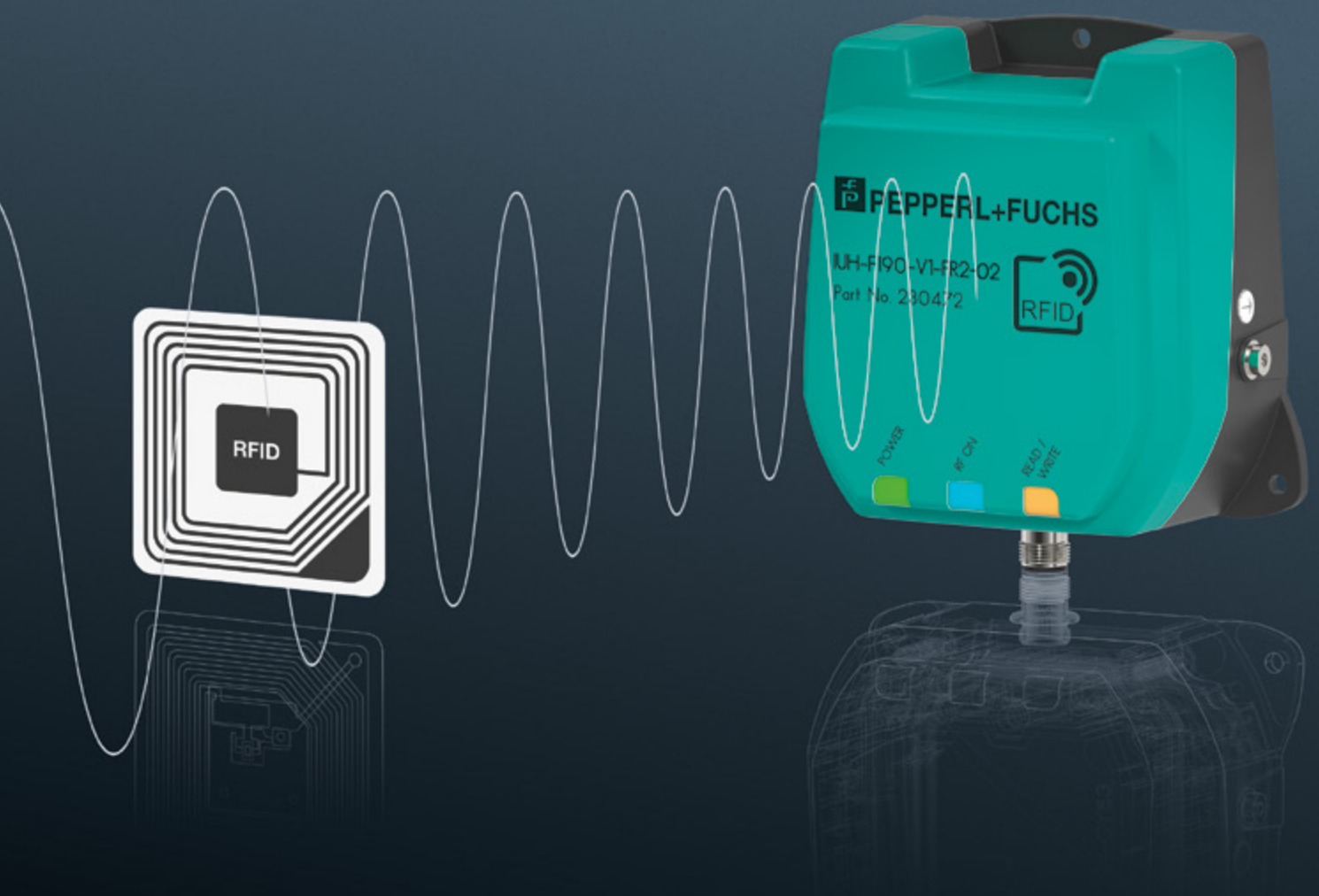

IDENTControl—A System for the Most Compatibility

The control interfaces in the IDENTControl system can be simply and flexibly integrated into almost any system environment. Furthermore, the control interfaces can be combined with a variety of read/write devices and tags, thus making them ideal for global use. In addition, the system's wide-ranging compatibility grants the user complete freedom when expanding their own system.

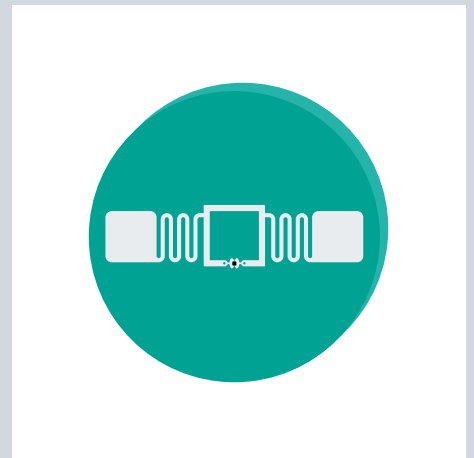

Multiple read/write devices of varying frequencies from the IDENTControl product family from Pepperl+Fuchs can be connected to the IDENTControl and IDENTControl Compact control interfaces. Connecting the devices is simple and hassle-free, ensuring total compatibility.

When a read/write device receives the data stored in a tag via its electromagnetic field, this data is automatically forwarded to the control interface and processed.



IDENTControl Series

The control interfaces in the IDENTControl series allow up to four read/write devices of varying RFID frequencies to be connected at the same time. In addition, it is possible to operate the separate devices jointly and connect trigger sensors. The devices are available for all standard fieldbus types and Ethernet protocols (PROFIBUS, PROFINET, EtherNet/IP, TCP/IP, MODBUS TCP), and they can therefore be used around the world. The LC display and function keys make commissioning the devices hassle-free, while the plug-in bus connections guarantee that installation is simple and the device is quick to replace—ensuring that your processes remain uninterrupted.



IDENTControl Compact Series

If installation space is limited, or you have a smaller RFID installation, the control interfaces in the IDENTControl Compact series are the perfect choice. With their compact design, the devices are perfectly suited for decentralized field mounting. They allow two read/write devices to be connected at the same time—or alternatively, one read/write device and one trigger sensor. In addition, the plug-in bus connections make installing the devices quick and simple, ensuring that your processes remain uninterrupted. The LED status display makes it possible to monitor the status of the device and bus communication on a continuous basis, thereby significantly increasing transparency.

Highlights of the IDENTControl System

- Connection/evaluation of all RFID frequencies on a single device
- EMC protection and sturdy, fully encapsulated metal housing for total noise immunity
- Simple system integration—can be connected to all standard fieldbuses
- Compact version for decentralized field mounting
- Display and function keys for easy commissioning
- Plug-in connections for simple handling

Excerpt of technical data	IC-KP	IC-KP2
Number of channels	Up to 4	Up to 2
Interfaces	PROFIBUS, PROFINET, EtherNet/IP, TCP/IP, MODBUS TCP, serial	PROFIBUS, PROFINET, EtherNet/IP, TCP/IP, MODBUS TCP, EtherCAT, CC-Link, serial
Degree of protection	IP67	

IO-Link Master—Intelligent and Future-Proof

The IO-Link masters from Pepperl+Fuchs are synonymous with high efficiency, incredible flexibility, and easy connection. The modules allow you to connect one module with up to eight IO-Link devices, allowing you to save on channel costs and benefit from a highly cost-effective application solution. Furthermore, end-to-end communication between the control and sensor levels forms the basis for converting Industry 4.0 applications—a secure investment in the future.

Sensorik

4.0

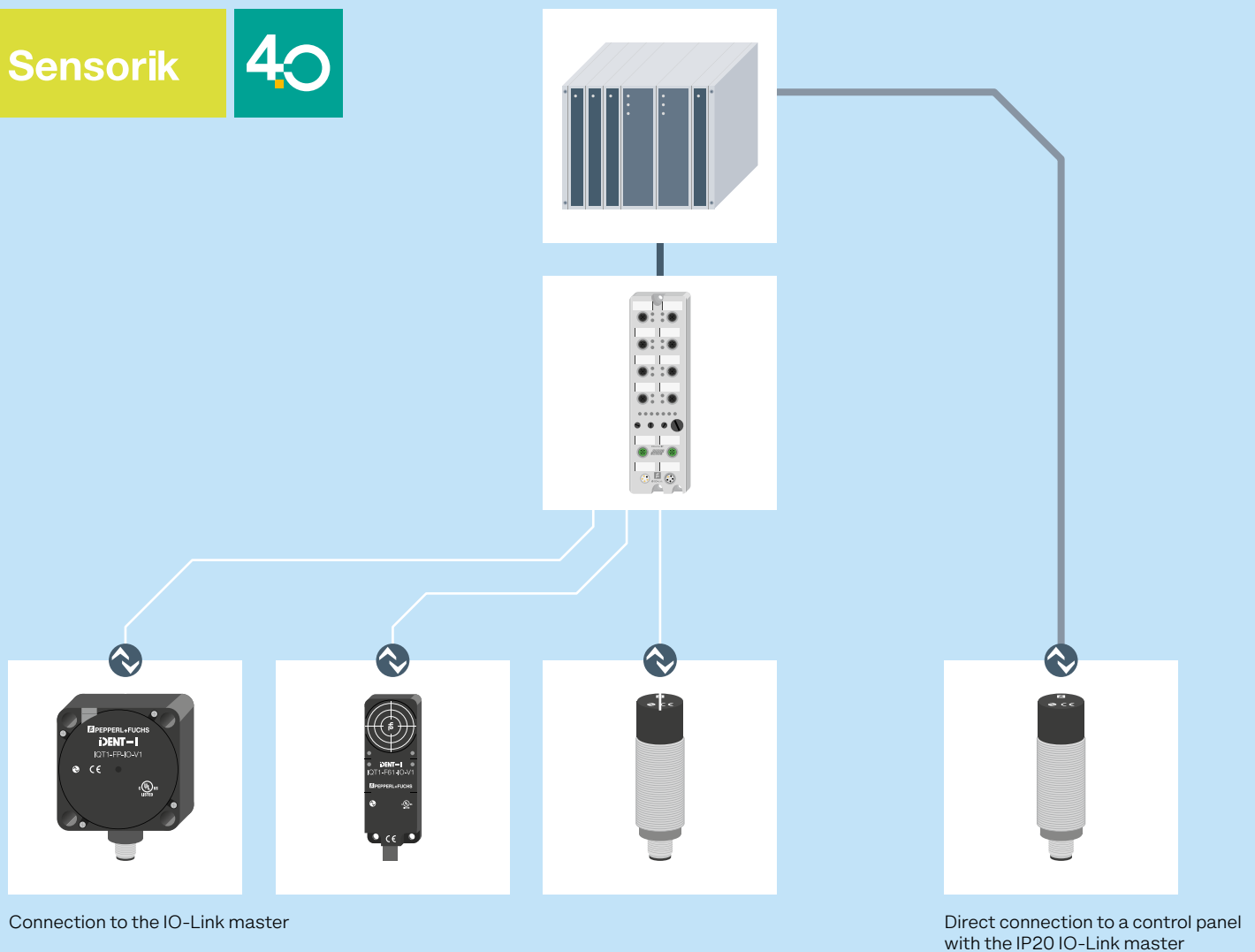

Alongside the IDENTControl family, Pepperl+Fuchs offers an optimized complete solution for applications that use IO-Link technology. The IO-Link master enables all read/write devices to be connected to the IO-Link interface in a simple and cost-effective manner, providing a future-proof identification solution.

Simple Connection of IO-Link Read/Write Devices

The standard IO-Link can be used with devices from any manufacturer and makes full use of sensor intelligence. For this reason, Pepperl+Fuchs offers various IO-Link masters for connecting RFID IO-Link devices in the most efficient way possible. For example, these modules can be used to connect up to eight read/write devices, thereby significantly reducing channel costs and enabling the most cost-effective solution.

Flexibility for the Future

IoT-optimized ICE2* and ICE3* modules offer everything that flexible cloud applications need. With MultiLink™, multiple sources can access the device in parallel and make the right data available wherever it is needed. Whether with a traditional PLC and an industrial PC or as a purely cloud-based application, IO-Link masters from Pepperl+Fuchs offer the most flexibility and planning reliability.



Highlights ICE2/3

- Integrated web server and IODD interpreter enable simple configuration via a web browser
- OPC UA and MQTT interface for cloud-based applications that pave the way for future Industry 4.0 scenarios

Enabling Process Reliability and Standardization

Designed for traditional PLC-based applications, the ICE1* modules offer greater process reliability. The integrated web server can be activated or deactivated as needed. This means the module is only accessible via the PLC—external access is blocked. With a multiprotocol capability, the IO-Link masters offer a great deal of efficiency for standardizing machines and plants. The innovative, high-performance connection technology optimizes installation.



Highlights ICE1

- All standard Ethernet communication protocols are supported in one single module for optimal machine standardization
- Designed for traditional PLC-based applications

Excerpt of technical data	ICE2-8IOL-G65L-V1D ICE3-8IOL-G65L-V1D	ICE2-8IOL-K45*-RJ45 ICE3-8IOL-K45*-RJ45	ICE1-8IOL-G60L-V1D	ICE1-8IOL-G30L-V1D
Inputs/outputs	8-port IO-Link master			
Housing	Polyamide (encapsulated)	Polyamide	Die-cast zinc—nickel-plated surface	
Rated current	16 A	3.7 A	2 × 16 A	
Operating temperature	-25 °C ... +60 °C	-40 °C ... +70 °C	-25 °C ... +70 °C	
Degree of protection	IP67	IP20	IP69	
Dimensions	212 × 65 × 30 mm	118 × 45 × 114 mm	200 × 59.6 × 30.7 mm	225 × 30 × 43 mm

Highly Reliable at Short Distances

Up to
10 cm

Powerful, interference-free technology, and total accuracy: these are the characteristics that set the LF read/write devices from Pepperl+Fuchs apart. With a wide range of versions and housing designs, we offer the perfect solution for every installation scenario. Devices are well-suited for both near-field applications in assembly and conveyor technology and demanding applications in the food industry.

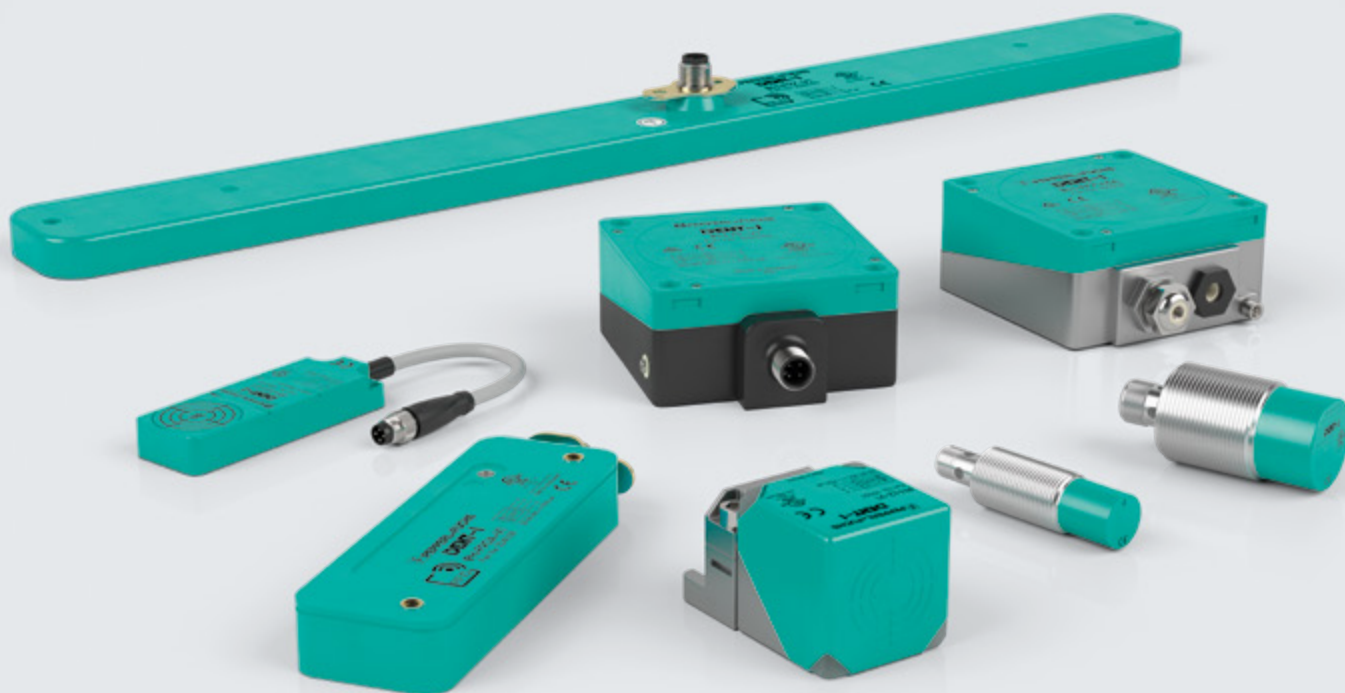

Extensive Portfolio for Every Installation Scenario

Read/write devices with a low frequency range (125 kHz) are the perfect solution for applications involving an operating distance of 0 to 100 millimeters. Pepperl+Fuchs offers a complete portfolio of devices for such applications. These devices boast an impressively high level of reliability, even when used in metallic environments.

The wide variety of cylindrical and cubic designs are available in various sizes and housing designs and are guaranteed to bring more flexibility to any application. In addition, Pepperl+Fuchs offers a number of special designs that have been optimized to meet requirements specific to each industry.

The portfolio includes solutions such as cylindrical LF systems with an M18/30 thread, specially designed to be flush mounted on metal. The Varikont L®, among others, is available in a cubic design and can be aligned in a variety of different ways.

The portfolio also contains devices specifically designed for the food industry, which are housed in stainless steel and resistant to cleaning agents (IP67/68/69K). Special designs tailor-made for use in warehousing and material handling are another highlight from this collection. These are perfect for installation along the sides of or between rollers in conveyor systems.

Typical Applications

- Assembly technology and material handling: use in metallic environments
- Warehousing and material handling: tray identification in roller conveyor systems
- Mechanical and plant engineering: machine access or protection against counterfeiting
- Manufacturing process: identification tasks in kanban racking systems

Highlights

- Wide variety of housing designs (cubic/cylindrical) for optimal integration
- Smaller designs with minimal space requirements
- Extra-compact versions for flush mounting on metal
- Special designs optimized for integration into roller conveyor systems
- For demanding applications (e.g., in the food industry)

Excerpt of technical data	18GM	30GM	FP	FP7V4A	L2	F61	F90A	F97
Order designation	IPH-18GM-V1	IPH-30GM-V1	IPH-FP-V1	IPH-FP7V4A	IPH-L2-V1	IPH-F61-V1	IPH-F90A-V1	IPH-F97-V1
Typical read distance	1 to 50 mm	1 to 65 mm	0 to 100 mm	0 to 100 mm	1 to 75 mm	2 to 45 mm	3 to 90 mm	1 to 70 mm
Typical write distance	0 to 40 mm	1 to 55 mm	0 to 80 mm	0 to 80 mm	2 to 65 mm	2 to 35 mm	3 to 80 mm	1 to 58 mm
Dimensions	ø 18 × 66 mm	ø 30 × 66 mm	80 × 80 × 40 mm	80 × 80 × 40 mm	67 × 40 × 40 mm	80 × 28 × 12 mm	126 × 43 × 20 mm	540 × 50 × 15 mm
Degree of protection	IP67			IP69K	IP67			

Efficient Control of Logistics Processes

Efficiently Controlled Material Redelivery (1)

Modern “push” manufacturing concepts featuring kanban systems make planning for production demand simple since manufactured parts are replenished automatically. This means, for instance, that it is possible to use small, versatile mounting units without interrupting the production process, as the necessary materials are redelivered in an efficient manner. For this purpose, the exceptionally flat read/write devices in the F61 series can be integrated into the mounting unit racks. When the raw material containers equipped with integrated tags are returned, the read/write devices are able to detect which materials are running low and can initiate the replenishment process early on.

Reliable Even at the Lowest Temperatures (2)

It must be possible to track products throughout the entire cold chain when handling perishable foods such as fish, meat, and fruit. To ensure end-to-end tracking, tags are affixed to transport containers and pallets, where they are read using RFID L2 read/write devices or inscribed with additional information if required. These devices guarantee an optimal read result, even at temperatures as low as $-25\text{ }^{\circ}\text{C}$. This ensures that the cold store process runs as efficiently as possible with high throughput volumes, and it means that products stay fresh throughout.

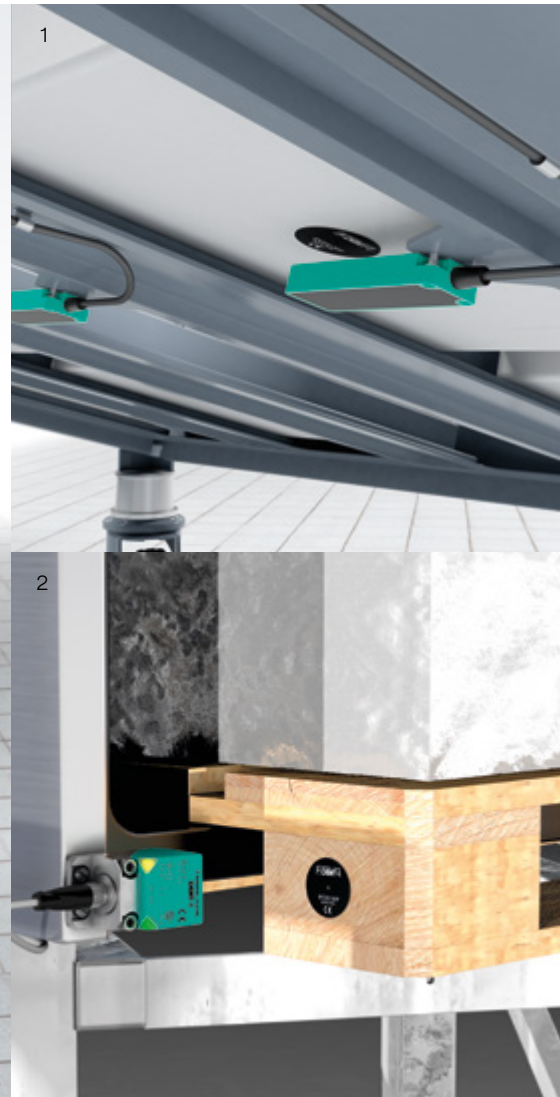

Perfect for Quick Conveyor Systems (3)

In the warehousing and material handling industry, it is essential that products are assigned correctly, processed quickly, and packaged in the most efficient way during the commissioning stage. A track-and-trace solution offers the additional advantage of being able to locate deliveries at all times. In a warehouse, circulating containers are identified using RFID read/write devices from the F97 series, and the products found within these containers are monitored via a central system. These devices can be mounted on the side of the roller conveyors or integrated directly into the conveyors themselves. Once the devices are installed, passing containers can be reliably identified at all times by means of their tags, regardless of their positioning or condition.

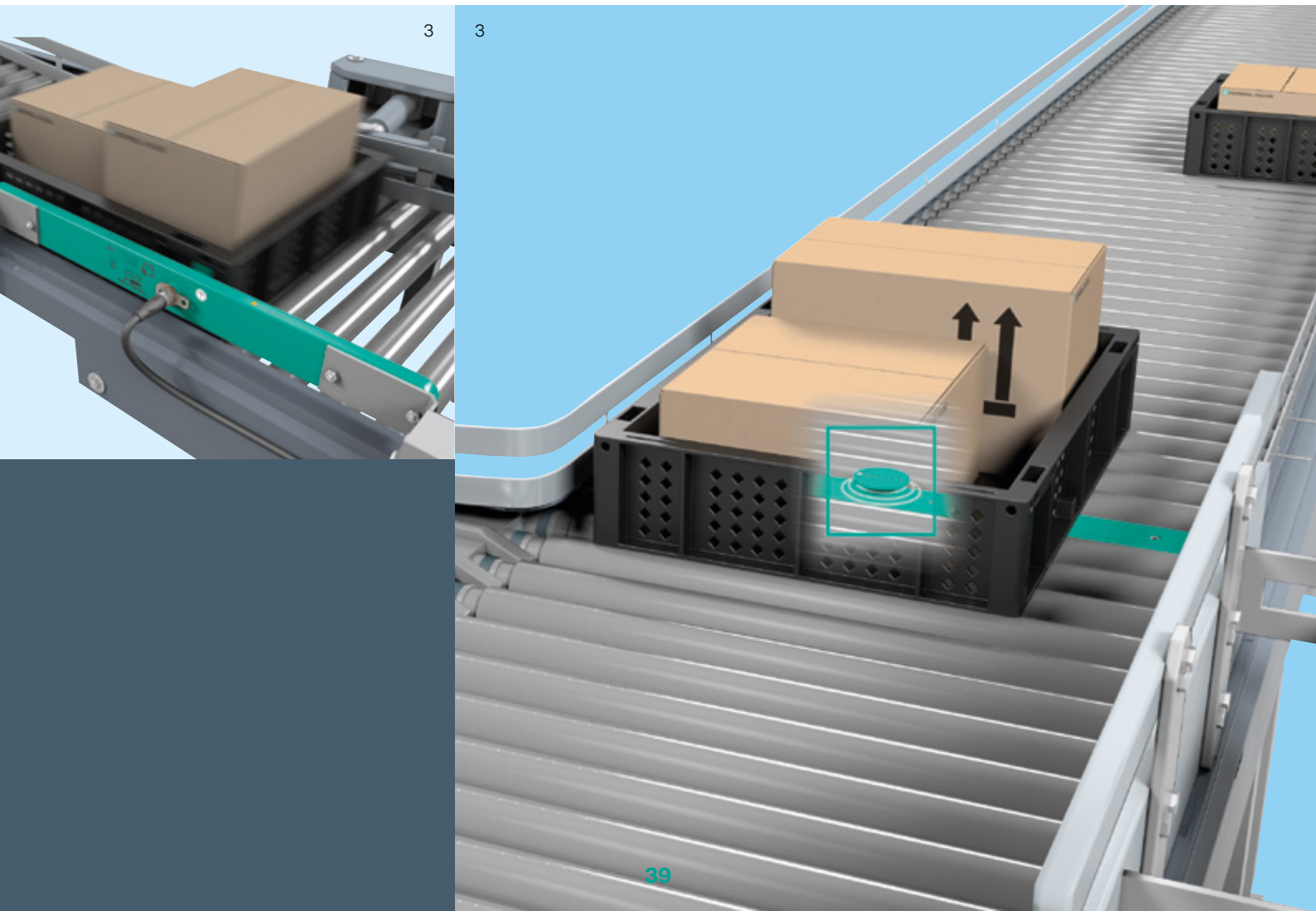

Perfect for Large Amounts of Data and High Speeds

Up to
30 cm

Applications in which large amounts of data are being transferred at high speeds really play to the strengths of HF read/write devices. For such applications, Pepperl+Fuchs offers a comprehensive range of devices in a wide variety of designs and housings. Perfect for every application and with a clear focus on the factory of the future, IO-Link technology provides the perfect foundation for establishing cross-hierarchical connectivity in line with Industry 4.0.



Designs Suited to Every Application

High-speed applications in which large amounts of data are being transferred call for read/write devices in the high frequency range (13.56 MHz). These read/write devices offer fully reliable read results in all near-field applications up to 30 centimeters, making them the ideal solution for identifying pallets and trays in material handling.

For these types of applications, Pepperl+Fuchs offers a wide variety of cylindrical and cubic designs in various sizes and

housings. In addition, the portfolio includes versions designed for specific applications, such as the F198, whose ring-shaped design makes it perfectly tailored to the requirements of the tire industry.

Another feature of the latest generation of HF RFID read/write devices in the optimized “flat pack design,” for example, is an IO-Link interface for connecting to all standard IO-Link masters. This interface provides the foundation for establishing cross-hierarchical connectivity in line with Industry 4.0.

Typical Applications

HF systems are ideal for handling large amounts of data at high speeds.

- Food and beverages industry: traceability of food products, pallet identification in cold stores
- Warehousing and material handling: object identification on monorail conveyors
- Mobile equipment: driver identification, detection of attachments, and protection of tool extensions
- Automotive industry: identification of skids, detection of battery packs for electric vehicles

Highlights

- Maximum process reliability in near-field applications through fault-free operating principle based on inductive coupling
- High flexibility: extensive portfolio and special designs for a wide range of requirements
- Particularly robust due to high degree of protection and extended temperature range
- Multitag reading of multiple transponders for maximum efficiency
- Flexible commissioning: connection via IDENTControl or IO-Link for optimum integration into the application

Excerpt of technical data	18GM	FP		FP74VA	F61	F198
Order designation	IQH1-18GM-V1 IQT1-18GM-IO-V1 (IO-Link)	IQH1-FP-V1 IQT1-FP-IO-V1 (IO-Link)	IQH3-FP-V1 IQT3-FP-IO-V1 (IO-Link)	IQH1-FP7V4A	IQH1-F61-V1 IQT1-F61-IO-V1 (IO-Link)	IQH1-F198-V1 IQH1-F198-M-V1
Typical read distance	0 to 50 mm 0 to 55 mm (IO-Link)	0 to 130 mm	0 to 300 mm	0 to 130 mm	0 to 55 mm	0 to 150 mm
Typical write distance	0 to 50 mm 0 to 55 mm (IO-Link)	0 to 130 mm	0 to 300 mm	0 to 130 mm	0 to 55 mm	0 to 150 mm
Dimensions	ø 18 × 66 mm ø 18 × 63.5 mm (IO-Link)	80 × 80 × 40 mm	80 × 80 × 40 mm	80 × 80 × 40 mm	80 × 28 × 12 mm	190.5 × 175 × 12 mm
Degree of protection	IP67	IP67	IP67	IP69K	IP67	IP67

HF Read/Write Devices—Incredibly Versatile

Protection against Counterfeiting in Mechanical and Plant Engineering

In the production of ceramic tiles, surfaces are processed and printed with various designs. To ensure the quality of the product, it is essential that only genuine print rollers are used, not less expensive replica components. The read/write devices of the 18GM series were developed for such a purpose, and they can be integrated directly into the machine itself. Genuine parts

can be clearly identified using a tag embedded in the print roller. As a result, it becomes impossible for replicas to be used, and the quality of the products is guaranteed in the long term. This provides a simple solution for monitoring the handling of spare parts, and it makes it possible to plan maintenance cycles in the most efficient way possible.

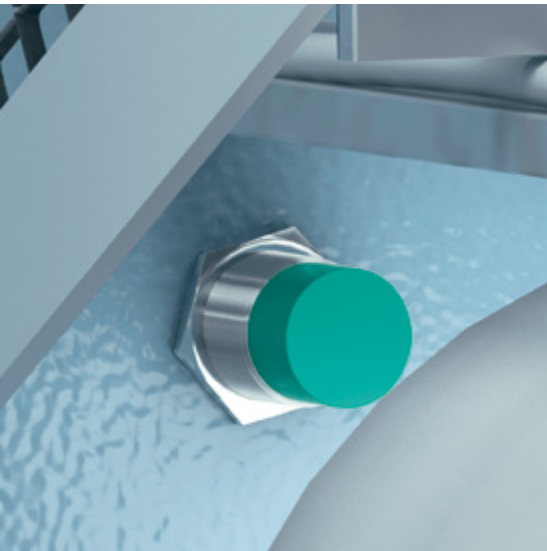

Unique Identification of Skids (1)

In automotive production, RFID technology can be used in a variety of applications. In most cases, tags are integrated into skids and monorail conveyors on which parts or entire bodysells are transported from one production station to the next. The stations themselves are fitted with HF read/write devices such as those in the FP series, and these read/write devices identify all parts at a short distance of up to 30 cm and trigger the next step in production. The devices can be mounted directly onto metal and ensure that all manufactured products are located and assigned reliably.

Reliable Identification of Semifinished Products (2)

Cap strip machines are commonly used in the preproduction of vehicle tires. Their task is to coat steel filaments with a rubber mixture, gather several strips together, and wrap these strips around a bobbin. A tag is embedded in the bobbin for the purpose of reliably identifying strips. This tag can be located at any time, both during the loading of the cap strip machines and at various positions on a circular segment further along in the process. The ring-shaped F198 read/write device is perfectly suited to reading applications such as this. The coil can be mounted on the machine in such a way that the tag is always located within the sensing range, thereby guaranteeing a reliable process and ensuring that the semifinished products can be tracked at all times.

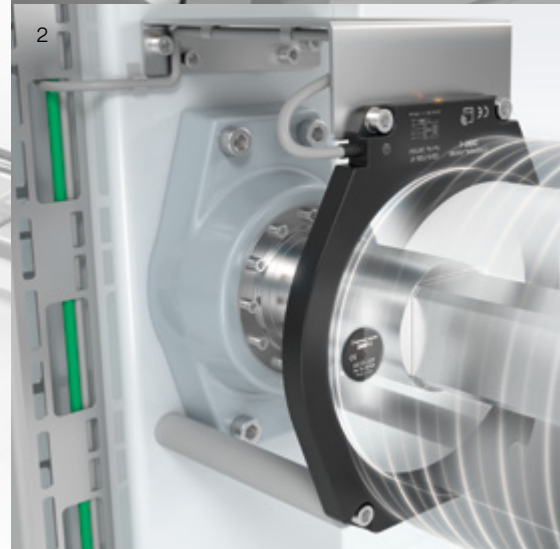
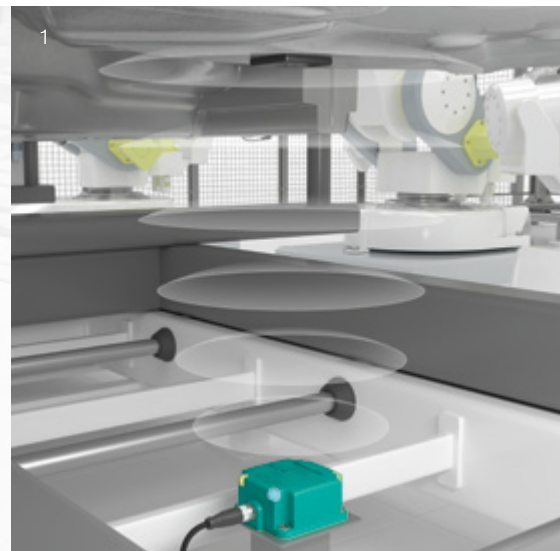
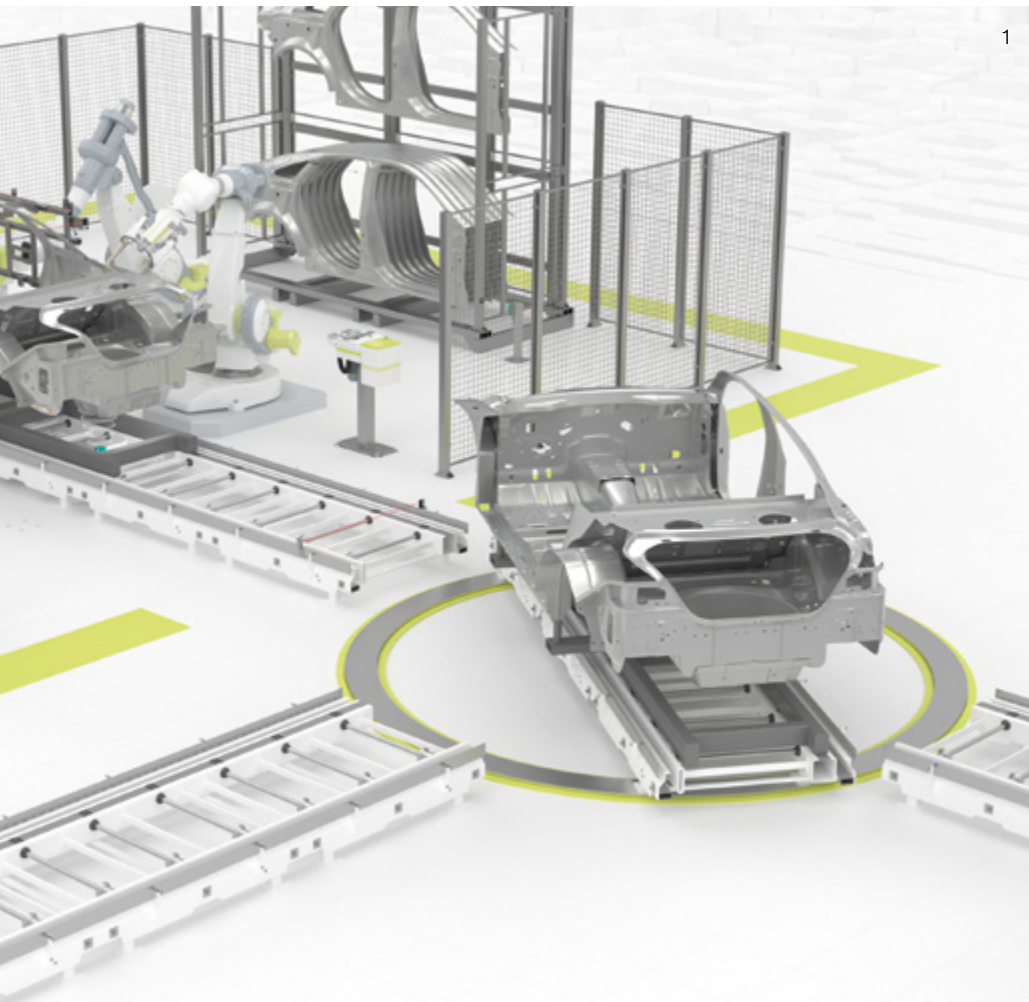

Maximum Performance for Global Use

Up to
6 m

Boasting incredible transparency, a high level of availability, and—most importantly—the possibility of being used anywhere in the world, the UHF read/write devices from Pepperl+Fuchs offer significant advantages for global companies in particular. Once all locations are equipped with products from the same series, system integration will be easier than ever, and processes will become much more efficient.



High Level of Flexibility for Large Detection Ranges

The UHF systems (865–928 MHz) from Pepperl+Fuchs are the perfect choice for all far-field applications requiring detection ranges of up to six meters. Due to the integrated antenna, these devices are equally ideal for use in confined spaces. All series (F190, F191, and F192) are available in the relevant frequency ranges for Europe, Asia, and the Americas, which is especially advantageous for global companies.

The read/write devices are capable of reliably identifying multiple RFID tags in a single read operation. Information can therefore be transferred at a quicker rate, throughput times can be reduced, and the efficiency of manufacturing and logistics processes can be significantly increased.

Preassembled functional modules allow the devices to be integrated into systems more quickly, and preset parameters that are specific to each country make installation far simpler. The devices are compatible with the IDENTControl system family, which means that users have the option of expanding their own systems at any time with maximum flexibility.

The switchable antenna polarization of the F190 and F192 series read/write devices allows optimum adaptation to a specific application without replacing the hardware.

With the standardized IO-Link interface of the F191 series, flexible connection to almost all bus systems and control systems is possible. Two operating modes are available for integration: in Easy Mode, the devices transmit their data

directly to the higher-level system according to the plug-and-play principle. Expert Mode provides additional configuration options.

Typical Applications

- Automotive industry: tag/label identification in car body manufacturing, painting lines, and final assembly
- Warehousing and material handling: bulk reading and identification of individual boxes, cardboard, etc.
- Vehicle identification at entrances or for monitoring access of people on premises

Highlights

- Maximum process reliability due to high degree of protection, extended temperature range, and adjustable transmit power
- Various housing designs and frequency ranges for global use
- Multitag reading of multiple transponders for maximum efficiency
- Easy installation: function blocks for effortless integration into the PLC
- High application flexibility due to sophisticated, compact design with integrated antenna

Excerpt of technical data	F190			F191	F192	
	IUH-F190-V1-FR*	IUT-F190-R4-V1-FR*	IUT-F190-B40-2V1D-FR*	IUT-F191-IO-V1-FR*	IUH-F192-V1-FR1*	
Order designation	IUH-F190-V1-FR*	IUT-F190-R4-V1-FR*	IUT-F190-B40-2V1D-FR*	IUT-F191-IO-V1-FR*	IUH-F192-V1-FR1*	
Interface	IDENTControl	Serial	PROFINET, EtherNet/IP, OPC UA*	IO-Link	IDENTControl	
Frequency range	UHF 865–928 MHz					
Antenna polarization	Switchable			Circular	Switchable	
Emitted power	3 ... 1,000 mW ERP adjustable			3 ... 100 mW ERP adjustable	10 ... 2,000 mW ERP adjustable	
Dimensions	114 × 112 × 63 mm			165 × 165 × 47 mm	270 × 268 × 81 mm	
Temperature range operation with nontransmission periods	-20 ... +70 °C	-20 ... +70 °C	-20 ... +70 °C	-25 ... +70 °C	-20 ... +70 °C	
Temperature range continuous transmission mode	-20 ... +60 °C	-20 ... +60 °C	-20 ... +50 °C	-25 ... +60 °C	-20 ... +60 °C	
Degree of protection	IP67					

*As of firmware version 2.0.0

UHF Technology for Efficient Processes

Read/Write Devices for the Automotive Industry

Production reliability and productivity are two of the main challenges facing the automotive industry. Since a great number of production steps take place at the same time in a confined space, there is a demand for devices with individually adjustable read ranges that do not suffer from cross-talk. Furthermore, the write function makes it possible to modify the tag information for downstream production steps.

The read/write devices used for this application control factors such as the design of the bodies, taking into account all of the parts required for the models. The read/write devices receive the necessary information relating to the model, colors, seats, and tires via the tags, and they guide the bodyshells on their skids to the right station via their control system. The F190 with external control interface or as a stand-alone solution from Pepperl+Fuchs is particularly suited for use in bodyshell production. This device performs impressively when completing tasks requiring a medium detection range and is also ideal for use in confined spaces with its compact design. In contrast, the F192 is primarily designed for use in applications that require a larger detection range, such as in the final assembly stage, at the test bench, and on hall doors.

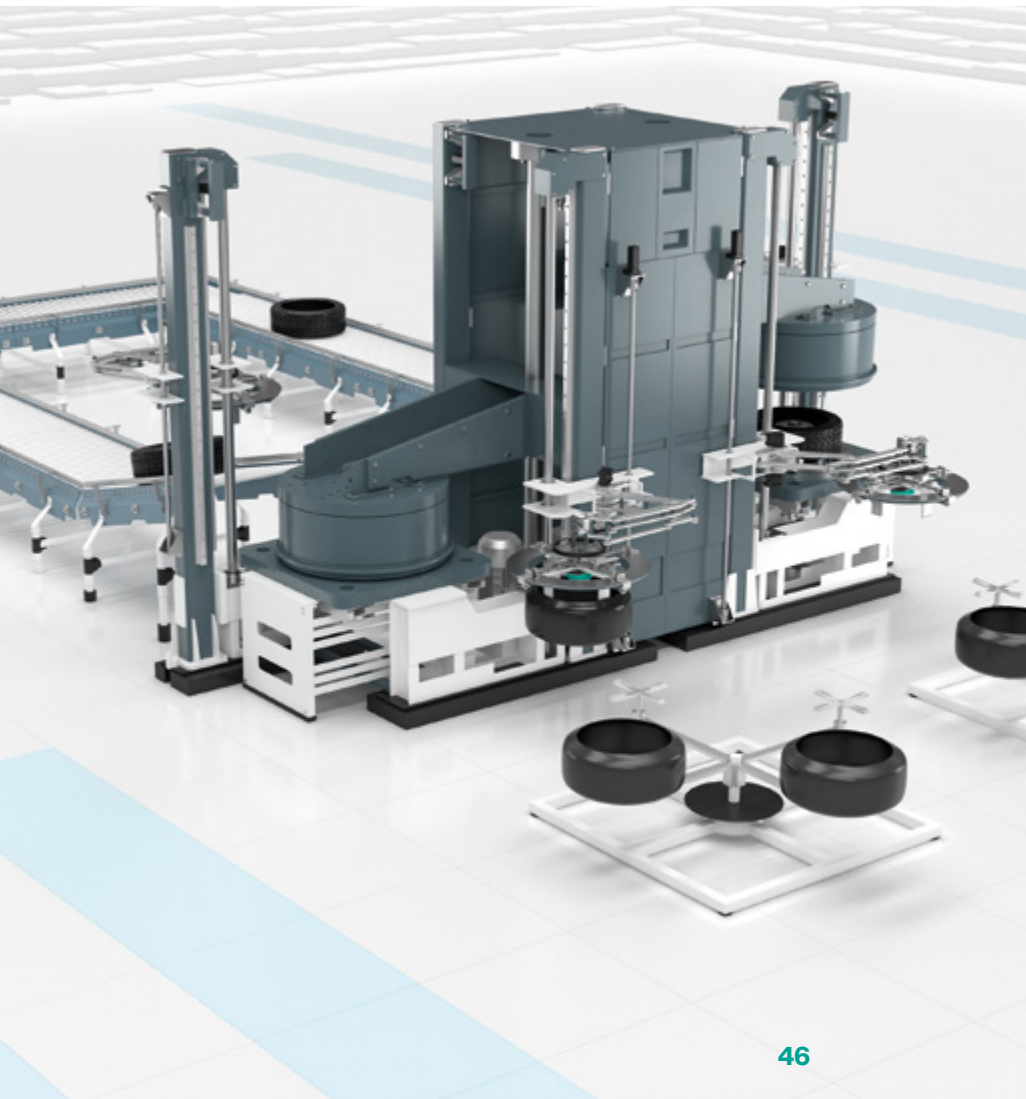

Bulk Detection with UHF at Large Distances

In logistics, products need to reach their destination quickly and reliably without any allocation errors. The F191 from Pepperl+Fuchs is perfectly designed to tackle any application involving a read distance of up to one meter. In a single bulk reading, the devices are capable of detecting data with total accuracy, ensuring maximum efficiency across all processes. The F192 UHF read/write device is the perfect choice for applications that require read distances of more than two meters. The device boasts a detection range of up to six meters and can read and write multiple tags at the same time, making it possible to achieve an exceptionally quick throughput and speed up processes considerably.

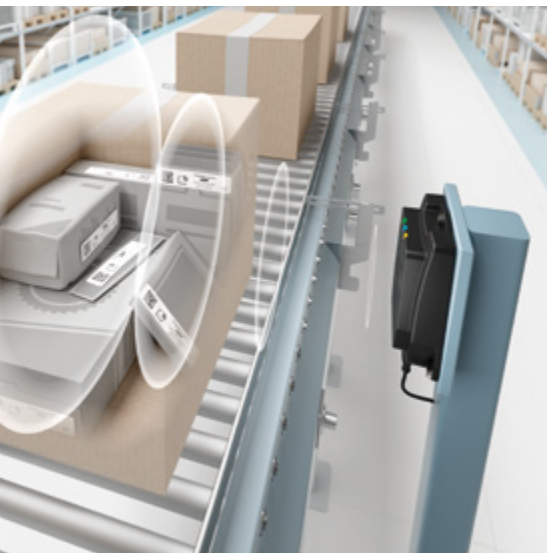

Seamless Traceability for Gate Applications

Up to
12 m

The powerful F800 RFID read/write device can detect a large number of tags simultaneously and in seconds. The reliable and seamless identification by means of RFID enables cost-efficient, fully automated data acquisition for the optimization of logistics processes.



High Sensitivity, Reliable Detection

Up to four antennas can be connected to detect objects with RFID tags, such as reusable containers, from different directions and over long distances of up to 12 m. The reliable identification of all tags is ensured by the high reception sensitivity and the high output power of 2 W. The read/write

device can detect a very large number of tags simultaneously and provide valid data even in time-critical applications. Eight LED lights provide permanent feedback on the status and function of the device and enable quick diagnosis.

Rugged Technology, Easy Operation

The RFID system is designed for industrial use and functions perfectly even in harsh environments. The UHF read/write device is accommodated in a rugged diecast aluminum housing. A previously used configuration can be easily transferred from one device to another via a USB stick using the configuration cloning function. This makes it easy to replace devices and minimizes downtime. The F800 series has serial and Ethernet interfaces and industrial M8 and M12 connectors. Various types of antennas are available for optimum adaptation to the operating location. Users also benefit from the comprehensive RFID portfolio from Pepperl+Fuchs, meaning they can obtain all devices and systems for their processes from a single source.

Highlights

- Cost-effective RFID gate solution for logistics applications
- Powerful UHF read/write device with up to four external antennas
- High reception sensitivity and high output power ensure reliable tag detection
- Fast reading of large UHF tag populations—even in time-critical applications
- Easy system integration via Ethernet, RS232 and USB



Extract from technical data

IUR-F800* read/write device

Sensing range	Up to 12 m
Output power	100 mW ... 2 W
Interfaces	Ethernet, RS232, USB
Temperature range	-40 °C ... +70 °C
Operating frequency	865 MHz ... 868 MHz, 902 MHz ... 928 MHz, others on request

Antenna type

IUA-F830*

IUA-F860*

Opening angle	65° × 65°	30° × 65°
Gain	9 dBic	11 dBic
Polarization	Circular	Circular

Versatility for Any Environment

Having important identification data available is crucial for ensuring a reliable and efficient process. Achieving this requires tags that operate with complete accuracy, anytime and anywhere. To handle such a task, Pepperl+Fuchs offers tags with the ideal frequency range, memory size, and design for all applications.

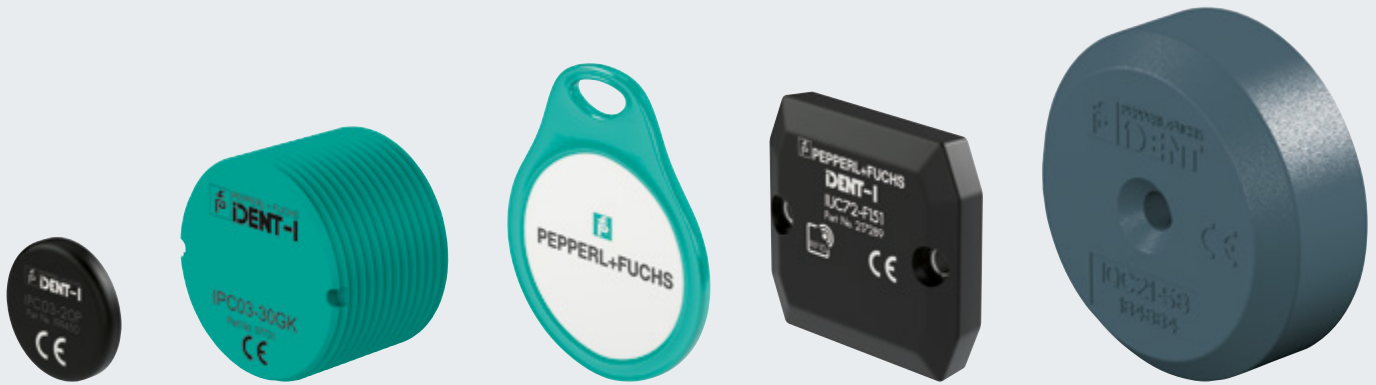

Powerful and Able to Withstand the Conditions of Any Environment

Tags carry important information that is vital for ensuring a smooth, reliable process flow. Pepperl+Fuchs offers a comprehensive portfolio of tags that have been optimized for industrial applications. The portfolio encompasses all frequency ranges as well as various memory sizes, designs, and mounting styles, thereby perfectly covering the broad spectrum of application requirements.

In addition to special labels printed on metal, cost-optimized paper or plastic labels are available. The range even includes extremely durable designs for mechanically or thermally demanding environments, such as high-temperature applications. These include tags that are resistant to oils, fuels, cleaning agents, and a variety of chemicals.

The application experts at Pepperl+Fuchs will help you choose the perfect read/write tag to ensure your RFID system solution delivers powerful performance. Customers have the additional option of requesting their tags to be tailored to their specific requirements.

Highlights

- Expert advice when choosing the most powerful tag for your application
- Comprehensive portfolio of RFID tags for LF, HF, and UHF frequency ranges
- Especially small tags that can be mounted in metal to extremely robust, thermally or chemically resistant versions

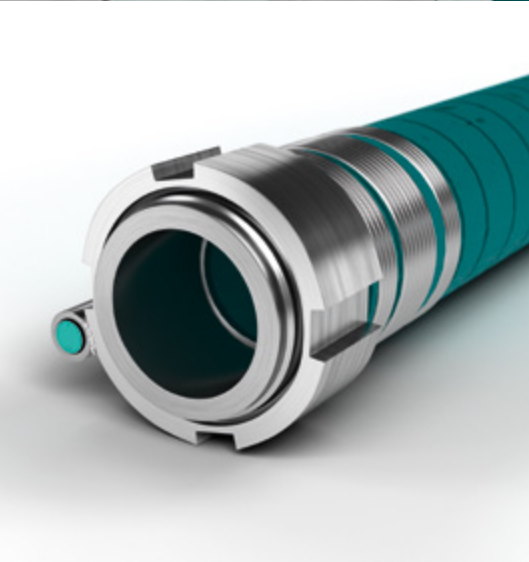
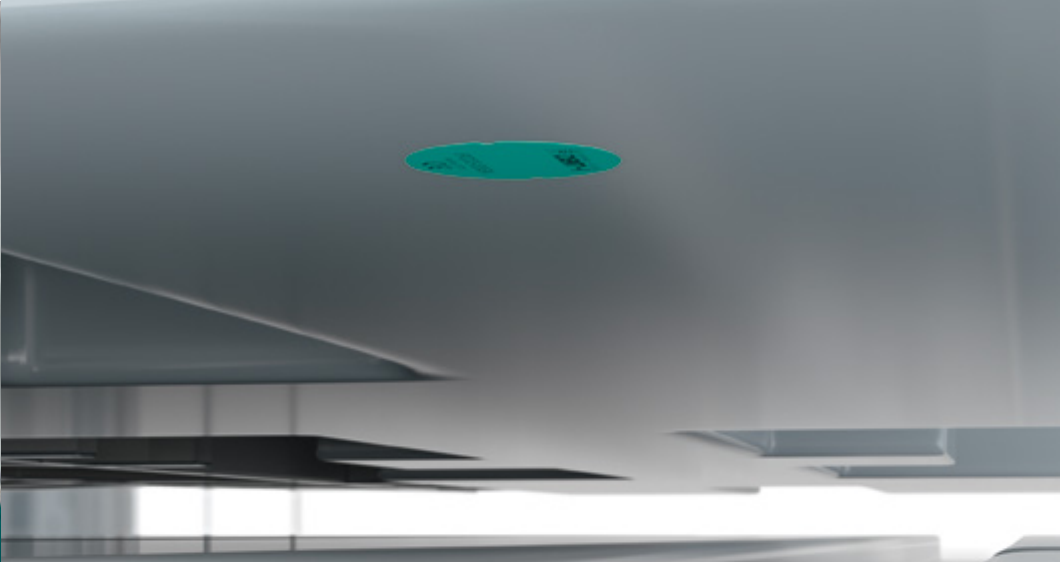
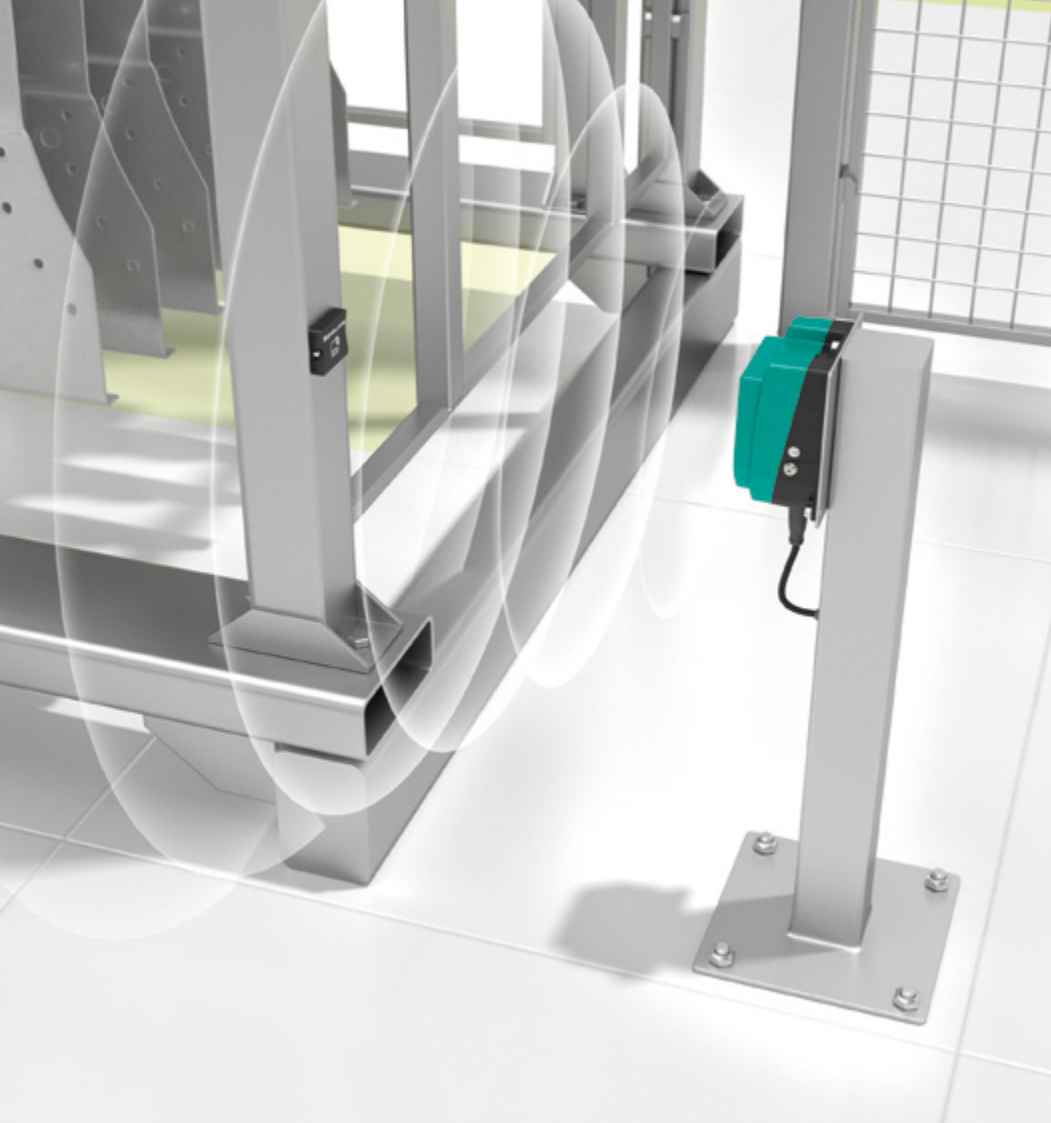

High Level of Flexibility for Mobile Use

Alongside stationary RFID systems, Pepperl+Fuchs offers powerful RFID handhelds for a wide range of mobile identification tasks. The modular devices are available in a variety of versions that cover all frequency ranges, providing maximum flexibility for data acquisition.



Modular, Efficient, and Future-Proof

Manual quality control and having several tasks in a process flow have one thing in common: they require the use of mobile devices for the purpose of identifying and editing tags. The RFID handheld from Pepperl+Fuchs is the perfect solution here—suitable for any application and all frequency ranges.

The HH5* series' handhelds feature an especially user-friendly design and powerful hardware. The RFID read/write devices for different frequencies (LF, HF, and UHF) are plug and play, and they can simply be pushed onto the base without using any tools. This allows the devices to be changed quickly even during ongoing operation.

The devices are available with Wi-Fi, Bluetooth, and Android™ Industrial+. This optimized operating system impresses with its especially high safety standards and long-term availability, and it provides a user interface that will be familiar to many users due to its parallels with the well-known smartphone OS.

Highlights

- Plug and play for quick and easy module changes
- Future-proof due to modern Android™ Industrial+ operating system
- Powerful processor and memory provide high performance for complex applications
- Large 4.8" TFT color display and demo software for convenient operation
- Degree of protection IP54 for industrial use indoors and outdoors



Handhelds—HH5* Series

The devices feature a large 4.8" color TFT display with LED backlight for ease of use and ensure optimal readability even in low-light conditions.

As an option, the basic device is available as a multifunctional identification handheld with a 5MP autofocus camera, lighting, and 2-D barcode reader. This allows the device to thrive in applications that require items such as RFID transponders, and when optical codes need to be read.

The devices with IP54 protection can be used in ambient temperatures from -20 °C to 50 °C. The comprehensive range of accessories includes a charging/docking station and rechargeable batteries.



Excerpt of technical data

Basic device

Model number	IC-HH51	IC-HH52
Description	Modular handheld, Android, touch screen	Modular handheld, Android, touch screen, 5 MP camera, 1-D/2-D barcode reader
Interface	Physical: USB and Ethernet connection via charger (accessories) Wireless connection: WLAN IEEE 802.11 a/b/g/n/ac/d/h/e/i/r/w/v (2.4 GHz/5 GHz) compatible with Bluetooth 5.0	
Dimensions	174 × 82 × 28 mm	
Degree of protection	IP54	

Excerpt of technical data

Read/write device



Read/write device



Model number	IPH-HH50	IQH1-HH50	IUH1-HH50-FR*
Operating frequency	LF (125 kHz)	HF (13.56 MHz)	UHF (Europe, USA, Canada, China)
Dimensions	43.8 × 84.2 × 33.5 mm		52 × 85 × 27 mm
Degree of protection	IP54		



Customizable Software for Greater Flexibility

Alongside the comprehensive hardware range, custom software solutions can be tailored to your application for optimal integration.

For more information, visit
pepperl-fuchs.com/RFID

Reliable Identification in Hazardous Areas

Introducing the perfect addition to the extensive portfolio of high-performance identification solutions from Pepperl+Fuchs: the Ident-Ex® 01 handheld from ecom for use in hazardous areas. A pioneer in mobile devices that are specially developed for this area, ecom is always looking for new ways to increase efficiency and productivity with long-lasting effects.



Intrinsically Safe Ident-Ex® 01 Handheld— Efficient and Versatile

In hazardous areas, collecting data can pose a serious challenge. The products offered by ecom include an intrinsically safe Ident-Ex® barcode scanner and RFID reader for performing demanding scanning tasks and 12-hour shifts in a simple and highly efficient process.

Thanks to its modular design, this sturdy handheld can be perfectly adapted to the specific requirements of various identification tasks. Several powerful head modules are available, and they can be replaced at an ecom service center as necessary. In addition, the Ident-Ex® 01 can be paired with ecom smartphones and tablets, and all other mobile devices, via Bluetooth connection.

Highlights

- Extra-sturdy and intrinsically safe
- High level of flexibility through interchangeable head modules
- Easy to operate with one hand
- Suitable for pairing with any Bluetooth device
- Ideal for intensive scanning tasks and 12-hour shifts
- Optional: service level agreement over three years (SLA)

Modular Read Heads for Individual Configuration

The unique modular concept of the Ident-Ex® 01 allows the customer to choose between various read head modules, enabling the handheld to be configured to suit customer-specific applications as closely as possible. Should the customer's application requirements change, the module on the unit can be replaced or supplemented by the ecom service center at any time.

One of the options available is a classic 1-D barcode laser scanner with a high motion tolerance and RFID technology for LF, HF, and UHF frequency ranges. A 2-D multirange imager is also available. Additional interchangeable modules allow RFID and 1-D scanners to be combined. This yields a modular system that combines state-of-the-art close- and long-range scan technology in a single device.

Excerpt of technical data

Ident-Ex® 01

Scanning performance	RFID ¹ : up to 1.5 m Barcode: 15 cm to 15 m
RFID operating frequency	LF 125/134 kHz HF 13.56 MHz UHF 868 MHz UHF 915 MHz
Barcode operating frequency	2-D multirange barcode imager 1-D laser scanner (additionally available as a combination of RFID and 1-D)
Bluetooth	Class II, up to approx. 10 meters
Dimensions	With Ex-25 head module: 235 × 84 × 58 mm Other head modules: 221 × 84 × 58 mm

¹ Dependent on scan tag and surroundings

The approval for explosion-hazardous areas can be found on our website.



Configure your Ident-Ex® 01 here:

pepperl-fuchs.com/ecom-configurator



1-D Short Range Laser (ZN)



2-D Multi Range EX25 (EN)



UHF RFID Reader (NE/NU)



Trovan RFID Reader (NT)



RFID AirCoil/Ferrite (NL/NF)



HF RFID (NH)



1-D Barcode + RFID AirCoil/
Ferrite/HF/ Trovan
(ZL/ZF/ZH/ZT)

Your automation, our passion.

Explosion Protection

- Intrinsic Safety Barriers
- Signal Conditioners
- FieldConnex® Fieldbus Infrastructure
- Remote I/O Systems
- Electrical Explosion Protection Equipment
- Purge and Pressurization Systems
- HMI Systems
- Mobile Computing and Communications
- HART Interface Solutions
- Surge Protection
- Wireless Solutions
- Level Measurement

Industrial Sensors

- Proximity Sensors
- Photoelectric Sensors
- Industrial Vision
- Ultrasonic Sensors
- Radar Sensors
- Rotary Encoders
- Positioning Systems
- Inclination and Acceleration Sensors
- Vibration Monitoring
- Industrial Ethernet
- AS-Interface
- IO-Link
- Identification Systems
- Displays and Signal Processing
- Connectivity

www.pepperl-fuchs.com

Subject to modifications • © Pepperl+Fuchs
Printed in Germany • Part. No. 70101812 11/23 06 • public



Pepperl+Fuchs Quality

Download our latest policy here:

www.pepperl-fuchs.com/quality