

USB Intrinsic Safety Barrier SK-PC-Z1D1-UU1-10-HS

Manual



Your automation, our passion.

 **PEPPERL+FUCHS**

With regard to the supply of products, the current issue of the following document is applicable:
The General Terms of Delivery for Products and Services of the Electrical Industry, published
by the Central Association of the Electrical Industry (Zentralverband Elektrotechnik und Elek-
troindustrie (ZVEI) e.V.) in its most recent version as well as the supplementary clause:
"Expanded reservation of proprietorship"

Worldwide

Pepperl+Fuchs Group
Lilienthalstr. 200
68307 Mannheim
Germany
Phone: +49 621 776 - 0
E-mail: info@de.pepperl-fuchs.com

North American Headquarters

Pepperl+Fuchs Inc.
1600 Enterprise Parkway
Twinsburg, Ohio 44087
USA
Phone: +1 330 425-3555
E-mail: sales@us.pepperl-fuchs.com

Asia Headquarters

Pepperl+Fuchs Pte. Ltd.
P+F Building
18 Ayer Rajah Crescent
Singapore 139942
Phone: +65 6779-9091
E-mail: sales@sg.pepperl-fuchs.com
<https://www.pepperl-fuchs.com>

1	History of the Manual	4
2	Introduction.....	5
2.1	Content of this Document.....	5
2.2	Target Group, Personnel	5
2.3	Symbols Used	5
3	Product Description	7
3.1	Intended Use and Function.....	7
3.2	Technical Data.....	8
3.3	Marking	9
3.4	Dimensions.....	10
3.5	Transport, Storage, and Maintenance.....	10
3.6	Disposal	10
4	Installation and Commissioning	11
4.1	Special Conditions of Use	11
4.2	General Installation Requirements	11
4.3	Requirements for Installation in Zone 2 (Gas).....	12
4.4	Requirements for Installation in Safe Area	12
4.5	Intrinsically Safe Wiring and Cable Parameters	13
4.6	Connections	14
4.7	Operating Conditions	15
4.7.1	Ambient Temperatures up to 60 °C	15
4.7.2	Ambient Temperatures up to 70 °C	16
4.8	Mounting.....	17
4.9	Dismounting	18
5	Operation.....	19
5.1	Component Overview.....	19
5.2	LED Indication and Basic Troubleshooting.....	20
6	Appendix	21
6.1	Accessories.....	21

1 History of the Manual

The following editions of the manual have been released:

Version	Comments
04/2022	Exchange EXTA2 to EXTA4

2 Introduction

2.1 Content of this Document

This document contains information that you need in order to use your product throughout the applicable stages of the product life cycle. These can include the following:

- Product identification
- Delivery, transport, and storage
- Mounting and installation
- Commissioning and operation
- Maintenance and repair
- Troubleshooting
- Dismounting
- Disposal



Note

This document does not substitute the instruction manual.



Note

For full information on the product, refer to the instruction manual and further documentation on the Internet at www.pepperl-fuchs.com.



Note

For specific device information such as the year of construction, scan the QR code on the device. As an alternative, enter the serial number in the serial number search at www.pepperl-fuchs.com.

The documentation consists of the following parts:

- Present document
- Instruction manual
- Datasheet

Additionally, the following parts may belong to the documentation, if applicable:

- EU-type examination certificate
- EU declaration of conformity
- Attestation of conformity
- Certificates
- Control drawings
- Additional documents

2.2 Target Group, Personnel

Responsibility for planning, assembly, commissioning, operation, maintenance, and dismantling lies with the plant operator.

Only appropriately trained and qualified personnel may carry out mounting, installation, commissioning, operation, maintenance, and dismantling of the product. The personnel must have read and understood the instruction manual and the further documentation.

Prior to using the product make yourself familiar with it. Read the document carefully.

2.3 Symbols Used

This document contains symbols for the identification of warning messages and of informative messages.

Warning Messages

You will find warning messages, whenever dangers may arise from your actions. It is mandatory that you observe these warning messages for your personal safety and in order to avoid property damage.

Depending on the risk level, the warning messages are displayed in descending order as follows:



Danger!

This symbol indicates an imminent danger.

Non-observance will result in personal injury or death.



Warning!

This symbol indicates a possible fault or danger.

Non-observance may cause personal injury or serious property damage.



Caution!

This symbol indicates a possible fault.

Non-observance could interrupt the device and any connected systems and plants, or result in their complete failure.

Informative Symbols



Note

This symbol brings important information to your attention.



Action

1. This symbol indicates a paragraph with instructions. You are prompted to perform an action or a sequence of actions.

3 Product Description

3.1 Intended Use and Function

The SK-PC-Z1D1-UU1-10-HS USB intrinsic safety barrier enables a host device (i.e., an industrial PC) that is in a Zone 2 environment to be connected to an EXTA4/EXTA3 keyboard or similar USB device in a Zone 1/21 environment.

The barrier enables operation of input devices, such as PC keyboards and trackballs, within Zone 1/21 and 2/22 hazardous areas. To transmit USB signals from and into hazardous areas, it converts the two USB channels into intrinsically safe circuits.

The device is IP20 rated. It must be protected accordingly from adverse conditions, such as water spray or dirt, that exceed the conditions of pollution degree 2.

As an associated apparatus, the SK-PC-Z1D1-UU1-10-HS barrier is certified to lead intrinsically safe circuits into Zone 1/21 hazardous areas. It is a one-to-one data connector. Data is passed through without buffering. The SK-PC-Z1D1-UU1-10-HS barrier does not provide galvanic insulation.

3.2 Technical Data



Supply	
Input voltage	4.75 ... 5.1 V DC (Um = 60 V SELV/PELV)
Input current	max. 200 mA
Power consumption	max. 2.7 W

Interface	
Interface type	4-screw terminal MSTBT 2.5 HC / 4-STP GY7035 USB 2.0 compatible

Directive conformity	
Electromagnetic compatibility	
Directive 2014/30/EU	EN 61326-1:2013 (industrial locations), EN 61000-6-4:2007+A1:2011
RoHS	
Directive 2011/65/EU (RoHS)	EN IEC 63000:2018

Ambient conditions	
Operating temperature	-20 ... 60 °C (-4 ... 140 °F) -20°C ≤ Ta ≤ 60°C / 70°C (depending on installation conditions)
Storage temperature	-40 ... 85 °C (-40 ... 185 °F)
Relative humidity	< 95% non-condensing
Shock resistance	18 shocks 15 g, 11 ms all axis, IEC 60068-2-27
Vibration resistance	10 ... 150 Hz, ± 0.075 mm, 1 g, 10 cycles per axis according to EN 60068-2-6

Mechanical specifications	
Degree of protection	IP20
Material	ME MAX 45 2-2 KMGY-2713706 refer to 42-3388
Cable	shielded cables must be used
Mass	approx. 220 g
Dimensions	45 mm x 99 mm x 114 mm
Mounting	DIN rail mounting
Cable length	5 m before device, 5 m after device, 10 m total

Data for application in connection with hazardous areas	
EU-Type Examination Certificate	EXA 18 ATEX 0054X
Marking	 II 3(2) G Ex ec [ib Gb] IIC T4 Gc  II (2) D [Ex ib Db] IIIC
Directive conformity	
Directive 2014/34/EU	EN 60079-0:2018 EN 60079-7:2015+A1:2018 EN 60079-11:2012

International approvals	
IECEx approval	IECEx EXA 18.0008X
Approved for	Ex ec [ib Gb] IIC T4 Gc [Ex ib Db] IIIC
Standards	IEC 60079-0:2017, IEC 60079-7:2015, IEC 60079-11:2011

3.3

Marking

SK-PC-Z1D1-UU1-10-HS modules are marked with the following:

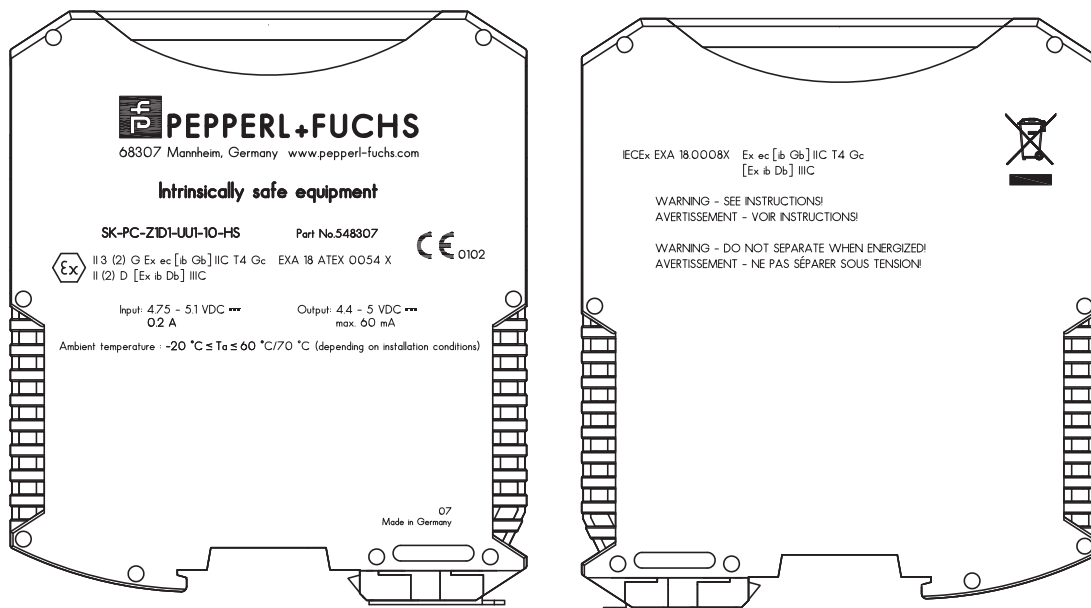

3.4 Dimensions

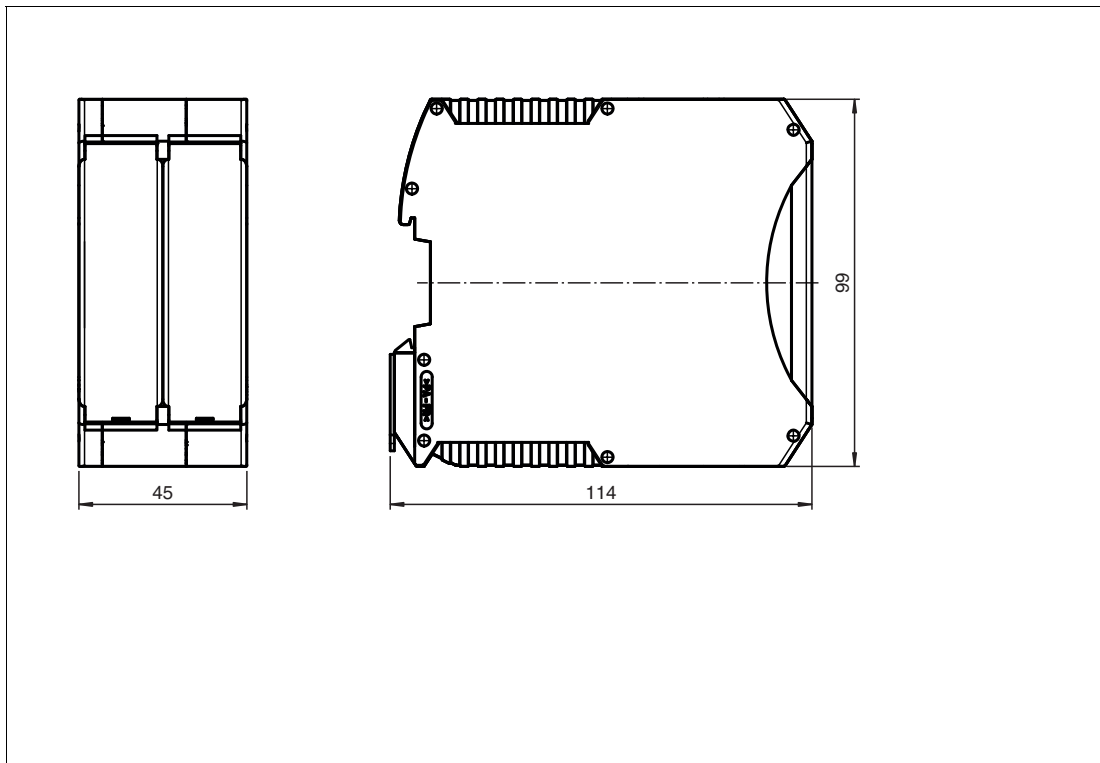

3.5 Transport, Storage, and Maintenance

In case of defect, the device must be removed and replaced with a new one. Store all devices in a clean and dry environment.

3.6 Disposal

Disposal of devices and their packaging material must be performed in compliance with the applicable laws and guidelines of the corresponding country. The devices do not contain batteries that need to be disposed separately from the products.

4 Installation and Commissioning

4.1 Special Conditions of Use

Installation in Areas Requiring Category 3G / EPL Gc Equipment

- The device shall only be connected to SELV/PELV circuits according to IEC 600950 or IEC 61010.
- The intrinsically safe circuits are connected to earth. Along the intrinsically safe circuits, equipotential bonding must exist.
- The device must be installed and operated only in surrounding enclosures that comply with the requirements for surrounding enclosures according to IEC 60079-0 and are rated with the degree of protection of at least IP54 according to IEC 60529.
- Connection or disconnection of energized non-intrinsically safe circuits is only permitted in the absence of a potentially explosive atmosphere.
- The device shall be mounted in horizontal position.

Requirements for Installation in Safe Area

- The device shall only be connected to SELV/PELV circuits according to IEC 60950 or IEC 61010
- The intrinsically safe circuits are connected to earth. Along the intrinsically safe circuits, equipotential bonding must exist.
- The device shall be mounted in horizontal position.

4.2 General Installation Requirements

Devices being operated in connection with hazardous areas may not be changed or manipulated. If there is a defect, the product must always be replaced with an original part. If devices have been operated in general electrical systems, they must not subsequently be operated in electrical systems related to explosive areas. The installation of the intrinsically safe circuits has to be conducted in accordance with the relevant installation regulations, particularly IEC/EN 60079-14.

4.3 Requirements for Installation in Zone 2 (Gas)

The device must be mounted in the non-explosion-hazardous area or hazardous area in category 3G / Zone 2 in a surrounding enclosure with a minimum protection of IP54 according to IEC/EN 60079-0. If the barrier is installed in a 3G / Zone 2 rated environment, connection or disconnection of energized non-intrinsically safe circuits is only permitted in the absence of a potentially explosive atmosphere.

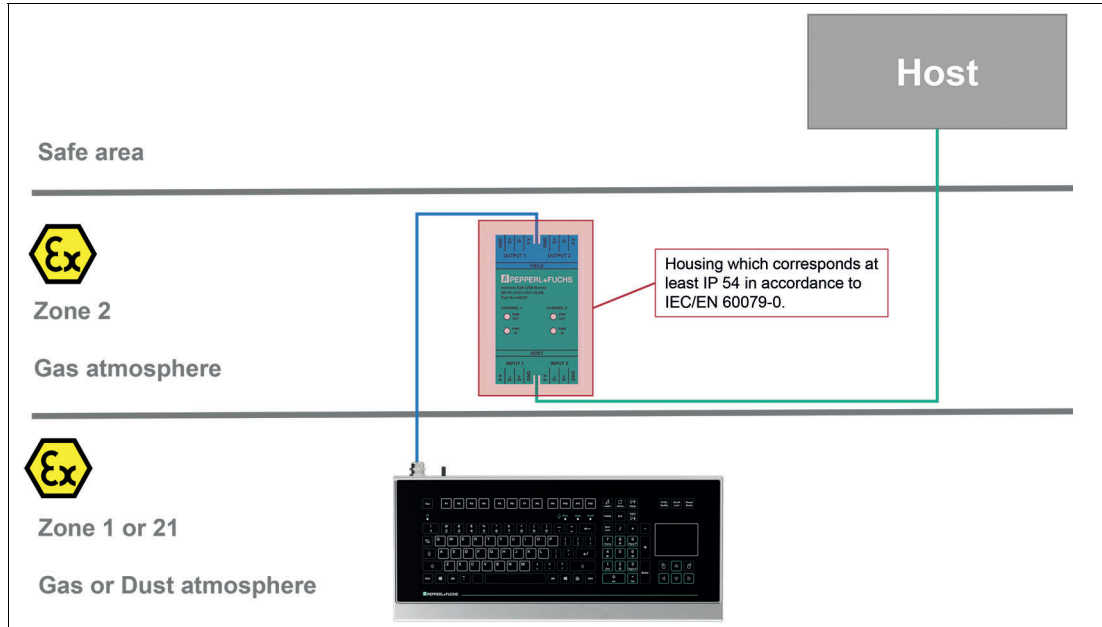

Figure 4.1 Installation requirements: Zone 2 (gas)

4.4 Requirements for Installation in Safe Area

For safety reasons, the device must only be installed in the safe area.

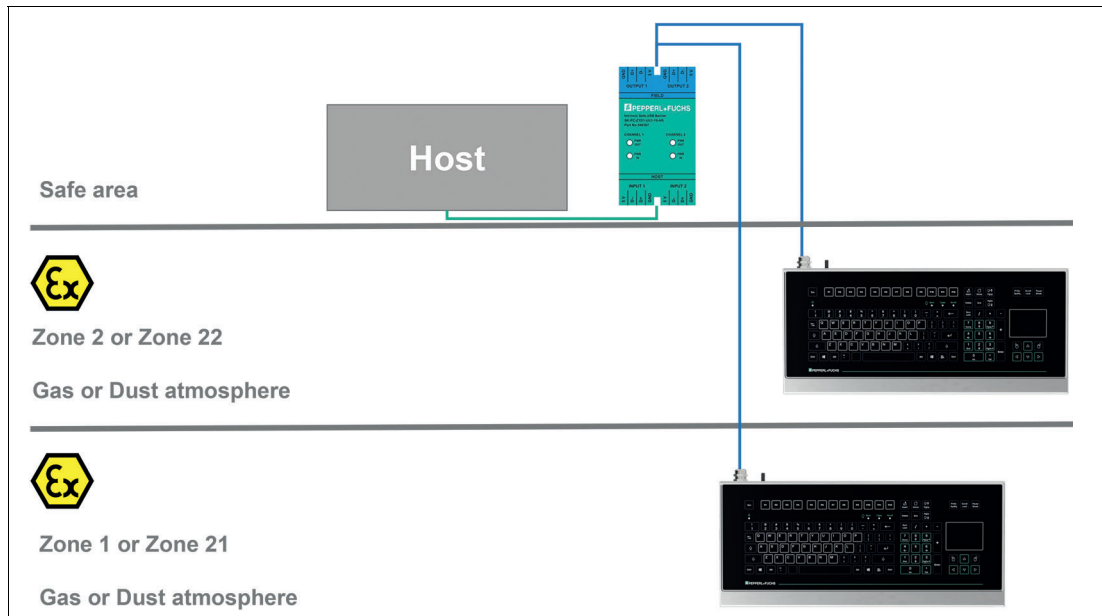
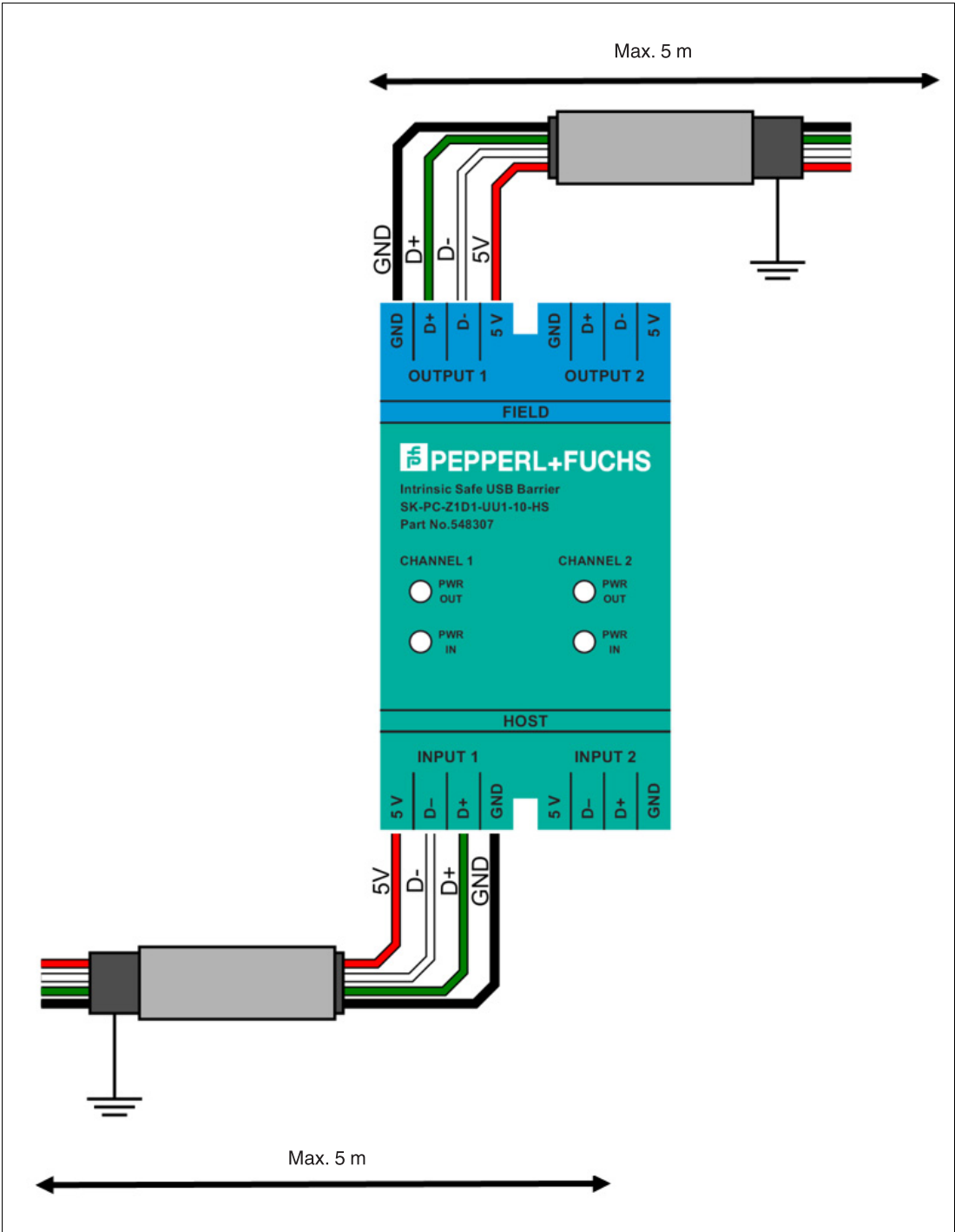

Figure 4.2 Installation requirements: safe area

4.5 Intrinsically Safe Wiring and Cable Parameters

Only use cables that meet the requirements of IEC/EN 60079-14 to connect to the terminals on the barrier. The length of the cables on both sides of the barrier should not exceed 5 m.



Warning!
Shielded cables and earth connection.
Shielded cables must be used. The cable shields must always be connected to earth.

4.6 Connections

Connector Table

Host (Input Side)				Cable
Connector	Terminal	Signal		Color Coding
		Name	Direction	
Input 1	KL1_1	5 V DC	Supply	red
	KL1_2	D-	I/O	white
	KL1_3	D+	I/O	green
	KL1_4	GND	Supply	black
Input 2	KL2_1	5 V DC	Supply	red
	KL2_2	D-	I/O	white
	KL2_3	D+	I/O	green
	KL2_4	GND	Supply	black

Intrinsically safe output side				Cable
Connector	Terminal	Signal		Color Coding
		Name	Direction	
Output 1	SL1_1	5 V DC	Supply	red
	SL1_2	D-	I/O	white
	SL1_3	D+	I/O	green
	SL1_4	GND	Supply	black
Output 2	SL2_1	5 V DC	Supply	red
	SL2_2	D-	I/O	white
	SL2_3	D+	I/O	green
	SL2_4	GND	Supply	black

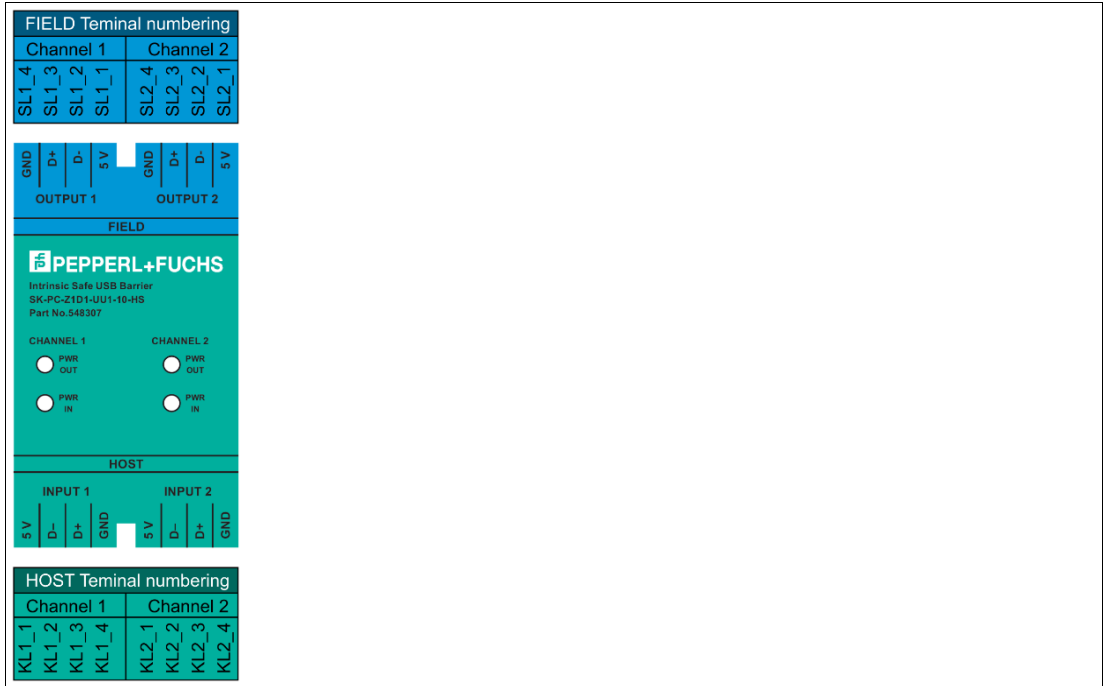

4.7 Operating Conditions

Installation varies depending on the maximum ambient temperature that the barrier operates in.

4.7.1 Ambient Temperatures up to 60 °C

The devices can operate directly next to each other at ambient temperatures up to 60 °C¹. In this scenario, the power dissipation of the adjacent devices must not exceed 2.0 W per device.

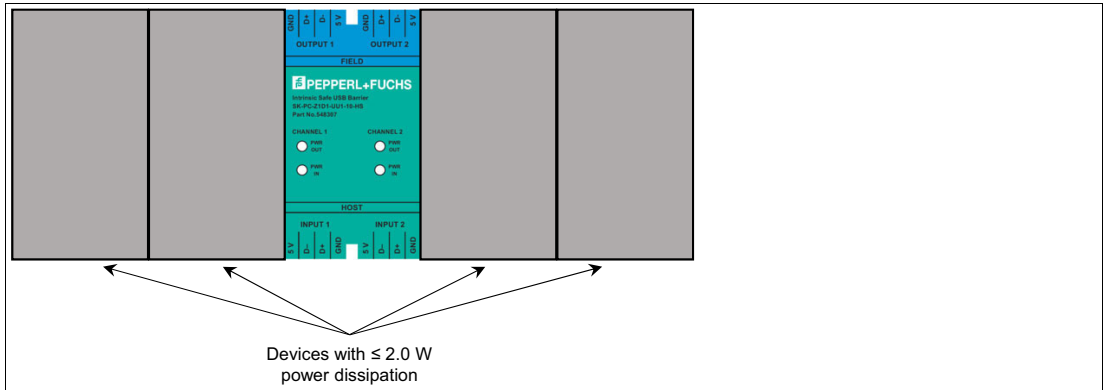

Figure 4.3 Devices with ≤ 2.0 W power dissipation can operate directly next to each other at ambient temperatures up to 60 °C.

With an additional spacer on the left side, the power dissipation of the adjacent devices must not exceed 2.7 W per device.



Warning!

Positioning of Spacer

Ensure that the spacer is installed on the left side of the barrier.

1. The ambient temperature must be measured at a distance of 50 mm from the middle-front of the barrier.

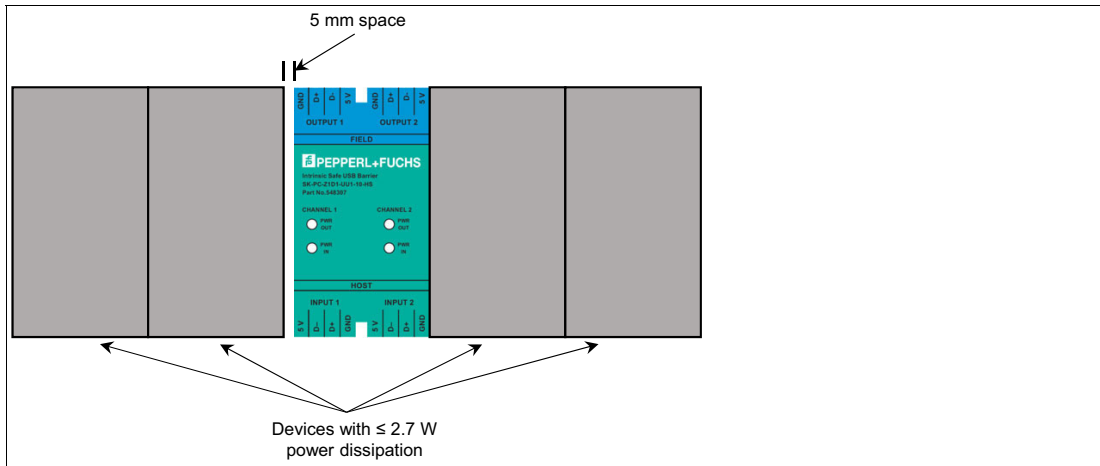

Figure 4.4 For devices with ≤ 2.7 W power dissipation, a 5 mm spacer must be installed on the left side of the barrier.

4.7.2 Ambient Temperatures up to 70 °C

The ambient temperature can be up to 70 °C¹ if the distance between the individual devices is more than 50 mm.



Warning!

Space between Devices

When operating devices up to 70 °C, the adjacent modules must be mounted at a distance of at least 50 mm on the left and right sides of the barrier.

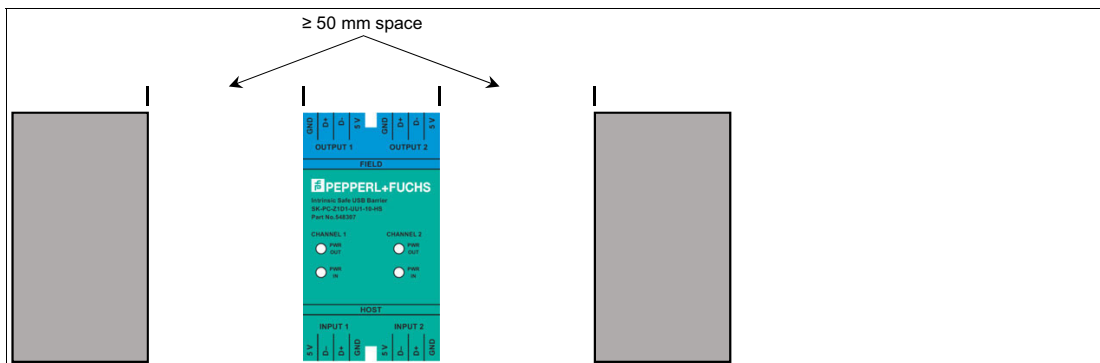

Figure 4.5 ≤ 50 mm space between devices at ambient temperatures up to 70 °C.

1. The ambient temperature must be measured at a distance of 50 mm from the middle-front of the barrier.

4.8 Mounting



Warning!

Mounting orientation

The DIN rail must be mounted horizontally. The device must be oriented such that that the field connections are on top.

Snap the device onto the DIN rail as follows:

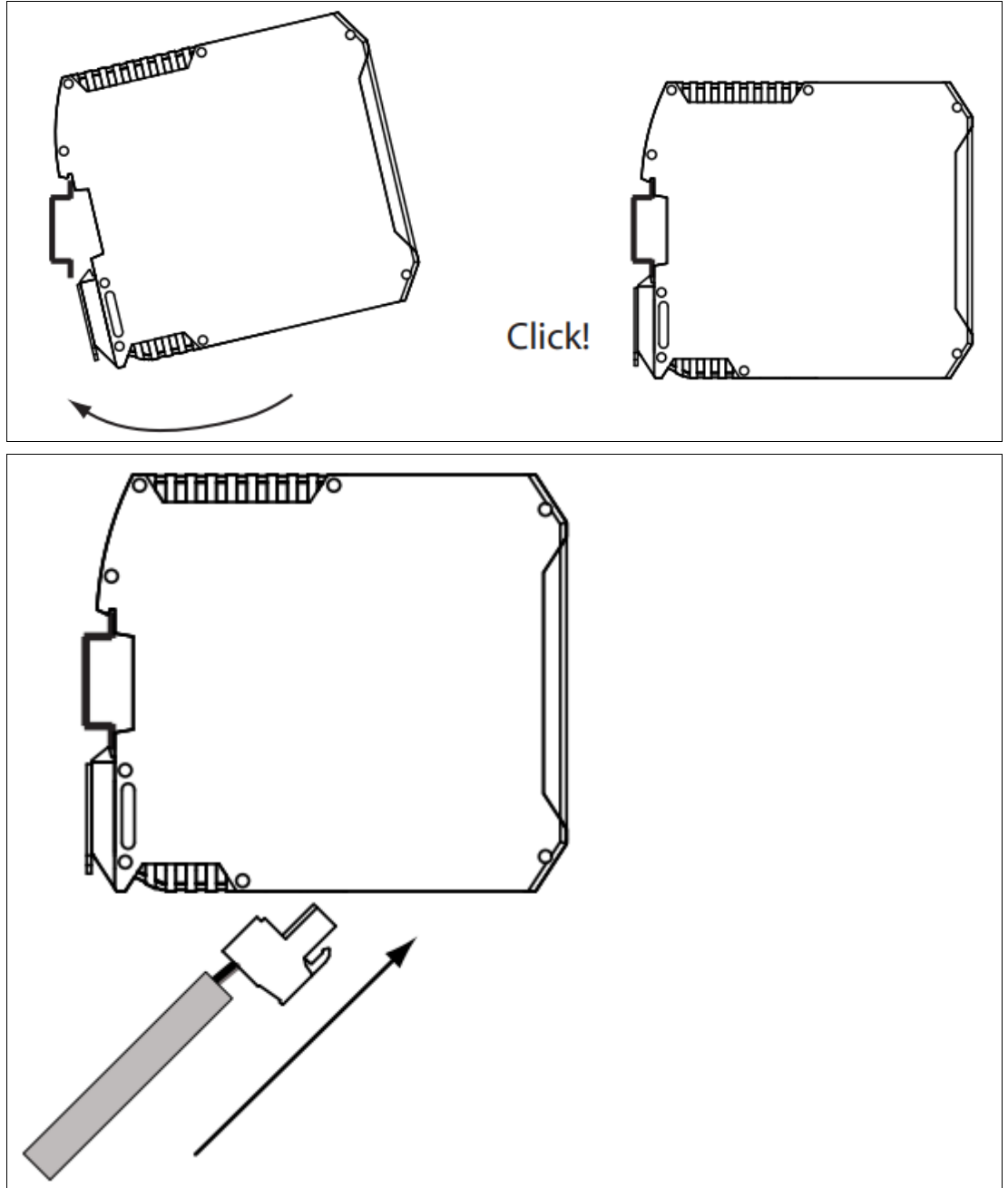

4.9 Dismounting

Use a screwdriver to loosen the fastening snap and remove the module from the DIN rail.

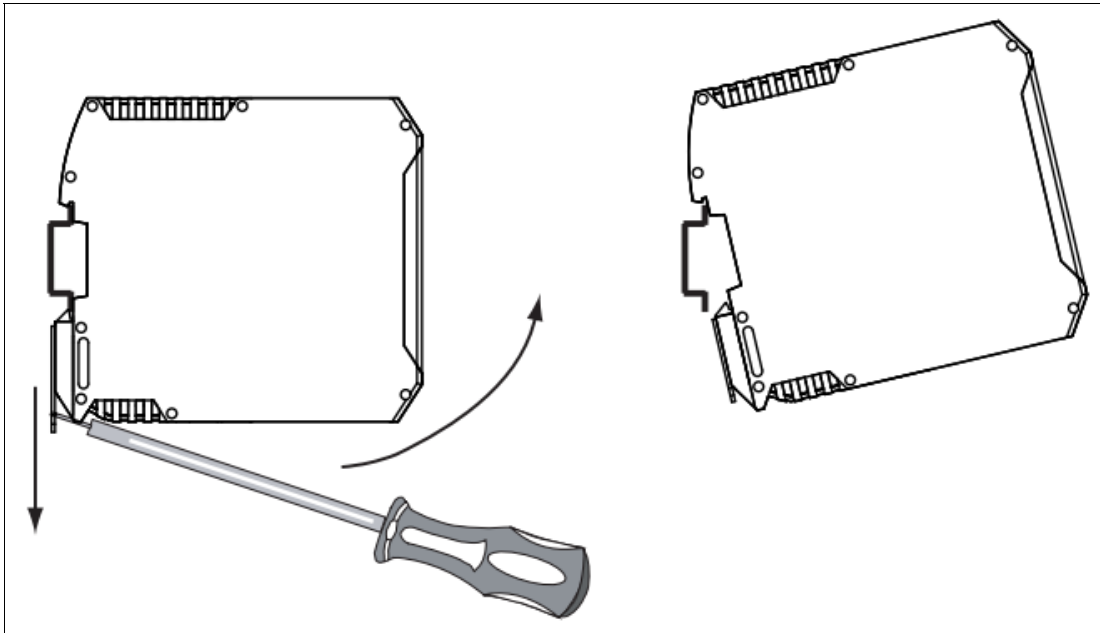

5 Operation



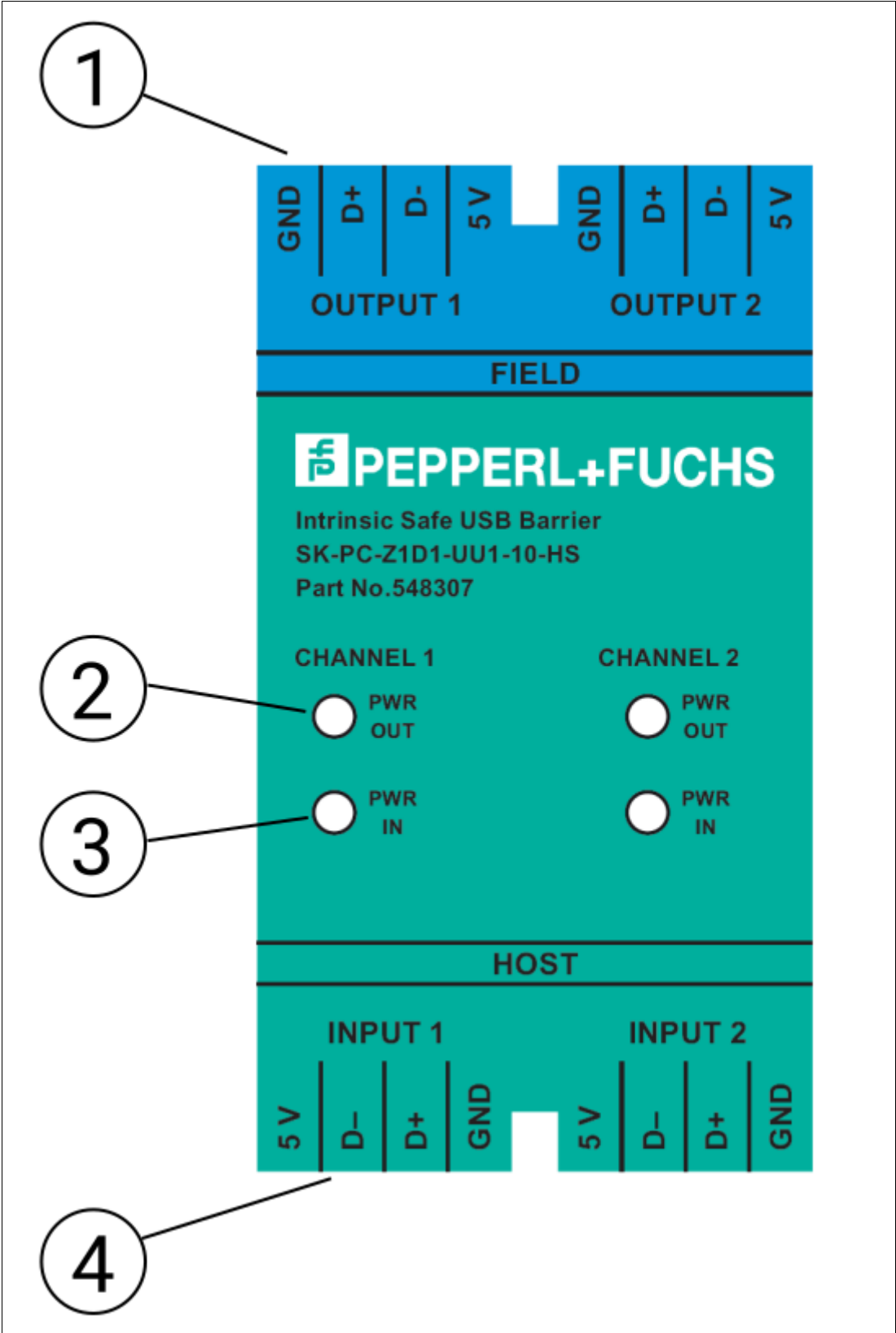



5.1 Component Overview



2022-04

1	Intrinsically safe connector
2	LED output power
3	LED input power
4	Non-intrinsically safe connector

5.2 LED Indication and Basic Troubleshooting

LED Indication	Meaning	Notes
 PWR OUT  PWR IN	No voltage available at the input connection	
 PWR OUT  PWR IN	Barrier active	
 PWR OUT  PWR IN	Lead on field connection too high or short circuit	Check short circuit on output side and consider the output current limits of the barrier.

6 Appendix

6.1 Accessories

Item Number	Name	Description
Contact sales for individual configuration	EXTA4 product family	Keyboard and mouse system—stand-alone option for Zone 1/21 hazardous locations
Contact sales for individual configuration	EXTA 3 product family	Keyboard and mouse system—stand-alone option for Zone 2/22

Your automation, our passion.

Explosion Protection

- Intrinsic Safety Barriers
- Signal Conditioners
- FieldConnex® Fieldbus
- Remote I/O Systems
- Electrical Ex Equipment
- Purge and Pressurization
- Industrial HMI
- Mobile Computing and Communications
- HART Interface Solutions
- Surge Protection
- Wireless Solutions
- Level Measurement

Industrial Sensors

- Proximity Sensors
- Photoelectric Sensors
- Industrial Vision
- Ultrasonic Sensors
- Rotary Encoders
- Positioning Systems
- Inclination and Acceleration Sensors
- Fieldbus Modules
- AS-Interface
- Identification Systems
- Displays and Signal Processing
- Connectivity

Pepperl+Fuchs Quality

Download our latest policy here:

www.pepperl-fuchs.com/quality

