

LB/FB PROFINET Gateway CFC für STEP 7

Manual



Your automation, our passion.

 **PEPPERL+FUCHS**

With regard to the supply of products, the current issue of the following document is applicable:
The General Terms of Delivery for Products and Services of the Electrical Industry, published
by the Central Association of the Electrical Industry (Zentralverband Elektrotechnik und Elek-
troindustrie (ZVEI) e.V.) in its most recent version as well as the supplementary clause:
"Expanded reservation of proprietorship"

Worldwide

Pepperl+Fuchs Group
Lilienthalstr. 200
68307 Mannheim
Germany
Phone: +49 621 776 - 0
E-mail: info@de.pepperl-fuchs.com

North American Headquarters

Pepperl+Fuchs Inc.
1600 Enterprise Parkway
Twinsburg, Ohio 44087
USA
Phone: +1 330 425-3555
E-mail: sales@us.pepperl-fuchs.com

Asia Headquarters

Pepperl+Fuchs Pte. Ltd.
P+F Building
18 Ayer Rajah Crescent
Singapore 139942
Phone: +65 6779-9091
E-mail: sales@sg.pepperl-fuchs.com
<https://www.pepperl-fuchs.com>

1	Version	5
2	Basic Principles	6
2.1	General	6
2.1.1	Driver-Components Concept	6
2.1.2	PCS 7 Version	6
2.1.3	GSDML	6
2.1.4	Module Numbers	6
2.2	Function of the Modules	7
2.2.1	Substitute Values	7
2.2.2	Quality Codes	7
2.2.3	Scaling	7
2.2.4	HART Auxiliary Variables	8
2.2.5	Simulation	8
3	RIOMOD Module	9
3.1	Description of RIOMOD	9
3.2	RIOMOD Connections	10
3.3	Message Texts and Associated Values of RIOMOD	11
4	Channel Modules	13
4.1	Notes on Using the Channel Modules	13
4.2	RIOAnIn—Analog Input Channel Module	14
4.2.1	Description/Functions of RIOAnIn	14
4.2.2	RIOAnIn Operating Modes	15
4.2.3	RIOAnIn Troubleshooting	15
4.2.4	RIOAnIn Reporting	15
4.2.5	RIOAnIn Connections	16
4.3	RIOAnOu—Analog Output Channel Module	18
4.3.1	Description/Functions of RIOAnOu	18
4.3.2	RIOAnOu Operating Modes	19
4.3.3	RIOAnOu Troubleshooting	19
4.3.4	RIOAnOu Reporting	19
4.3.5	RIOAnOu Connections	19
4.4	RIOCount—Analog Input Channel Module (Counter Modules)	21
4.4.1	Description/Functions of RIOCount	21
4.4.2	RIOCount Operating Modes	22
4.4.3	RIOCount Troubleshooting	22
4.4.4	RIOCount Reporting	22
4.4.5	RIOCount Connections	22
4.5	RIODiIn—Digital Input Channel Module	24
4.5.1	Description/Functions of RIODiIn	24
4.5.2	RIODiIn Operating Modes	24
4.5.3	RIODiIn Troubleshooting	24
4.5.4	RIODiIn Reporting	24
4.5.5	RIODiIn Connections	25

4.6	RIODiOu—Digital Output Channel Module.....	26
4.6.1	Description/Functions of RIODiOu	26
4.6.2	RIODiOu Operating Modes	26
4.6.3	RIODiOu Troubleshooting	26
4.6.4	RIODiOu Reporting.....	26
4.6.5	RIODiOu Connections	27
4.7	Troubleshooting	28
5	Project Planning.....	30
5.1	HW Config.....	30
5.2	CFC.....	32

1 Version

Document version	Changes	See
DOCT-6416	Version 1	-
DOCT-6416A	PCS7 V9.1 version added	Chapter 2.1.2
	GSDML version changed	Chapter 2.1.3

2 Basic Principles

This chapter contains information about the following topics:

- General
- Functions of the modules



Note

The project planning requires in-depth knowledge of handling the Siemens SIMATIC PCS 7. For more information about SIMATIC PCS 7, refer to the corresponding online help or documentation.

2.1 General

This section contains information about the following topics:

- Driver-component concept
- PCS 7 Version
- GSDML
- Module Numbers

2.1.1 Driver-Components Concept

The component concept is based on the PCS 7 standard. At the channel module, only the logical address of the process value of the submodule must be connected at input "PV_In" or at output "PV_Out." When compiling the CFC plans with the "generate module driver" option, the driver wizard automatically inserts all other blocks based on the hardware configuration and connects these accordingly.

Diagnostic messages are reported via the PCS 7 reporting system. The cyclic diagnostic data from the submodules is made available to the connected channel modules as a status word.

2.1.2 PCS 7 Version

The module libraries were created for **PCS 7 V9.0+SP1** and **PCS 7 V9.1** and are compatible only with this versions.

2.1.3 GSDML

The libraries were developed for the "**GSDML-V2.33-PF-RIO-LBFB-20200825.xml**" GSDML file. Fault-free operation with another GSDML version cannot be guaranteed.

2.1.4 Module Numbers

The following module numbers are used:

Module	FB number
RIOMOD	FB 300
RIODiIn	FB 301
RIODiOu	FB 302
RIOAnIn	FB 303
RIOAnOu	FB 304
RIOCount	FB 305

2.2 Function of the Modules

This section contains information about the following topics:

- Substitute values
- Quality Codes
- Scaling
- HART auxiliary variables
- Simulation

2.2.1 Substitute Values

Some channel modules offer the option of outputting substitute values at the process value outputs in case of a fault. This functionality is not the same for all channel modules and is described in more detail in the respective chapters.

2.2.2 Quality Codes

The channel modules have a quality code at many of their outputs in addition to the actual value. This indicates the status of the value. The following three quality codes are used:

Quality code	Meaning	Use
16#80	Valid value	There is no fault and the module is not in simulation mode.
16#60	Simulated value	The module is in simulation mode.
16#00	Invalid value	There is a fault (output "Bad" = true) and the module is not in simulation mode. 16#00 is also output for unavailable HART outputs.

2.2.3 Scaling

The scaling of the analog process values takes place in the modules themselves and the process values are already transferred as a floating point figure. Parameterization can be carried out via the parameters of the submodules in HW Config.

2.2.4 HART Auxiliary Variables

The RIOMOD module recognizes whether a HART submodule is being used via the submodule ID. In this case, in addition to the information about the analog input/output submodule, the submodule ID and the logical input address of the HART submodule are passed on using the "RIO_Conn" structure at the connected channel module.

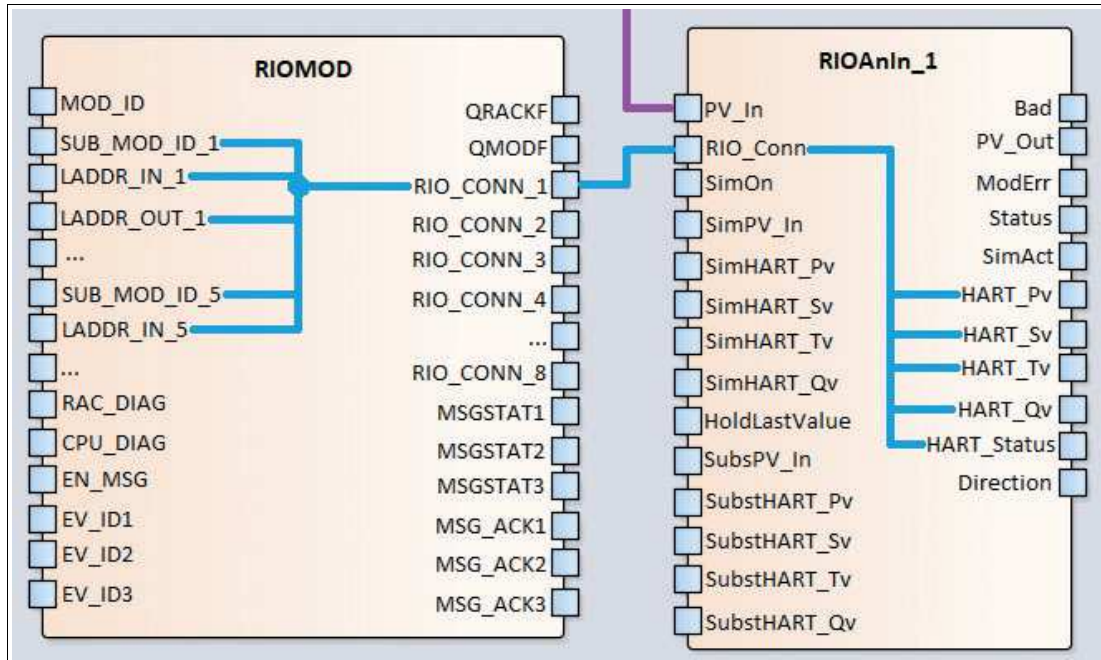

Figure 2.1 RIOMOD—Internal information distribution for HART modules

In the channel module, the HART auxiliary variables including status bytes are read and output to the corresponding outputs of the associated analog channel module. If a HART submodule delivers fewer than four auxiliary variables, the quality code of the unavailable HART outputs is set to 16#0 "Invalid Value."

In simulation mode, the inputs "SimHART_PV," "SimHART_Sv," etc., are passed on to the respective outputs "HART_PV," "HART_Sv," etc. The quality code of the outputs is set to 16#60 "Simulation."

If the input "HoldLastValue" from RIOAnIn = "false" or the input "HlvHART" from RIOAnOu = "false," in the case of a fault the substitute values "SubstHART_Pv," "SubstHART_Sv," etc., are passed on to the respective outputs "HART_PV," "HART_Sv," etc. The quality code is set to 16#0 "Invalid Value."

Simulation and substitute-value modes do not check how many auxiliary variables the interconnected submodule provides and pass the values of all four inputs to the corresponding outputs.

2.2.5 Simulation

Simulation mode is supported by all channel modules.

In simulation mode ("SimOn" = 1), the simulated values such as "SimPV_In" are passed directly to the associated outputs, e.g., "PV_Out." The outputs "Status," "Bad," "ModErr," and "HART_Status" are set to 0 in simulation mode. The "SimAct" output is set to 1.

The quality code of all outputs is set to 16#60 "Simulation." The simulation behavior of the HART auxiliary variables is described in chapter 2.2.4.

3 RIOMOD Module

This chapter contains information about the following topics:

- Description of RIOMOD
- RIOMOD connections
- Message Texts and Associated Values of RIOMOD

3.1 Description of RIOMOD

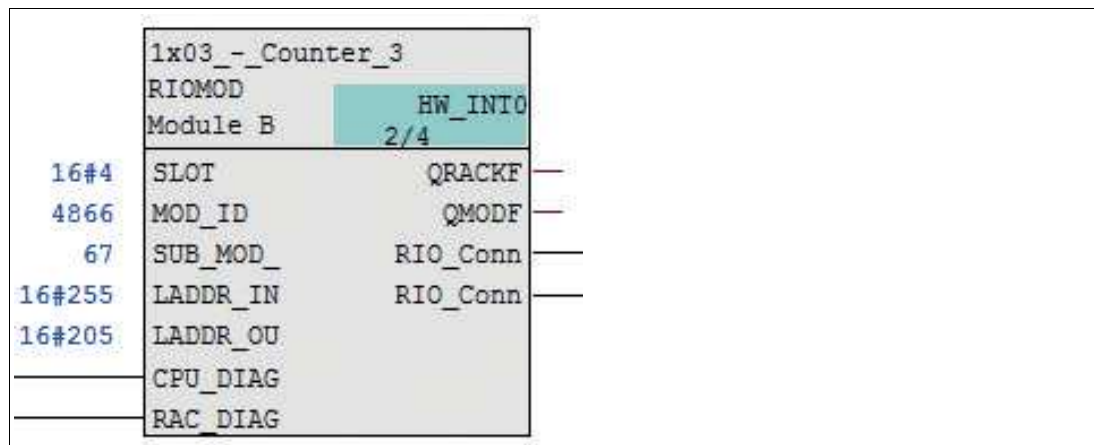

Figure 3.1 RIOMOD module

For each module configured in HW Config, a separate instance of RIOMOD is installed by the driver wizard, regardless of the type of module. All relevant information about the module and all associated submodules are written to the inputs of the module. Taking into account the module ID and submodule ID, these are forwarded to the corresponding channel modules via the structure outputs "RIO_CONN_1" to "RIO_CONN_8."

3.2 RIOMOD Connections

RIOMOD inputs

Input	Type	Visible	Description
EN	BOOL	X	Enable
SLOT	INT	X	Installation position of the module
MOD_ID	DWORD	X	Module ID
SUB_MOD_ID_1	DWORD	If present	Submodule ID, submodule 1
LADDR_IN_1	DWORD	If present	Logical input address, submodule 1
LADDR_OUT_1	DWORD	If present	Logical output address, submodule 1
...			
SUB_MOD_ID_8	DWORD	If present	Submodule ID, submodule 8
LADDR_IN_8	DWORD	If present	Logical input address, submodule 8
LADDR_OUT_8	DWORD	If present	Logical output address, submodule 8
EV_ID1	DWORD	-	Event ID 1
EV_ID2	DWORD	-	Event ID 2
EV_ID3	DWORD	-	Event ID 3
EV_ID4	DWORD	-	Event ID 4
EN_MSG	BOOL	-	1 = Enable Alarm

RIOMOD outputs

Output	Type	Visible	Description
ENO	BOOL	-	Enable Out
QRACKF	BOOL	X	1 = higher-level fault
QMODF	BOOL	X	1 = module pulled/faulty
MSGSTAT1	WORD	-	Message error information
MSGSTAT2	WORD	-	Message error information
MSGSTAT3	WORD	-	Message error information
MSGSTAT4	WORD	-	Message error information
MSG_ACK1	WORD	-	Message acknowledgment
MSG_ACK2	WORD	-	Message acknowledgment
MSG_ACK3	WORD	-	Message acknowledgment
MSG_ACK4	WORD	-	Message acknowledgment
RIO_Conn_1	STRUCT	If connected	Structure for the transmission of the relevant data to channel module, submodule 1
...			
RIO_Conn_8	STRUCT	If connected	Structure for the transmission of the relevant data to channel module, submodule 8

RIOMOD IN_OUTs

In/Out	Type	Visible	Description
CPU_DIAG	STRUCT	X	CPU diagnosis, used to respond to interrupts
RAC_DIAG	STRUCT	X	Rack diagnosis, analysis of rack faults

3.3 Message Texts and Associated Values of RIOMOD

RIOMOD reports relevant module and channel diagnostic messages to the PCS 7 reporting system. Rack diagnostics are processed by "OB_DIAG1 PN."

Alarm suppression has been implemented to ensure that no subordinate faults are reported in the reporting system as soon as a higher-level fault is present. So, in the event of a rack fault, no module faults are reported; in the event of a module fault, no channel faults of the module are reported. In addition, all subordinate messages are set to "outgoing" as soon as a higher-level fault occurs.

The following messages are created in German and in English:

Message module ALARM_8P	Message number	Default message text	Description
EV_ID1	SIG_1	English: Module @1%d@/@2%d@/@3@d@ Module pulled German: Modul @1%d@/@2%d@/@3@d@ Modul gezogen	Module pulled Type: PLC process control technology message, fault
EV_ID2	SIG_1	English: Module @1%d@/@2%d@/@3@d@: Open Wire at Channel 1 German: Modul @1%d@/@2%d@/@3@d@: Drahtbruch an Kanal 1	Open wire at channel 1. Type: PLC process control technology message, fault
EV_ID2
EV_ID2	SIG_8	English: Module @1%d@/@2%d@/@3@d@: Open Wire at Channel 8 German: Modul @1%d@/@2%d@/@3@d@: Drahtbruch an Kanal 8	Open wire at channel 8. Type: PLC process control technology message, fault
EV_ID3	SIG_1	English: Module @1%d@/@2%d@/@3@d@: Short Circuit at Channel 1 German: Modul @1%d@/@2%d@/@3@d@: Kurzschluss an Kanal 1	Short circuit at channel 1. Type: PLC process control technology message, fault
EV_ID3
EV_ID3	SIG_8	English: Module @1%d@/@2%d@/@3@d@: Short Circuit at Channel 8 German: Modul @1%d@/@2%d@/@3@d@: Kurzschluss an Kanal 8	Short circuit at channel 8. Type: PLC process control technology message, fault
EV_ID4	SIG_1	English: Module @1%d@/@2%d@/@3@d@: Line Fault at Channel 1 German: Modul @1%d@/@2%d@/@3@d@: Leitungsfehler an Kanal 1	Line fault at channel 1. Reported only if NO short circuit and NO interruption on the same channel. Type: PLC process control technology message, fault

Message module ALARM_8P	Message number	Default message text	Description
EV_ID4
EV_ID4	SIG_8	English: Module @1%d@/@2%d@/@3%d@: Line Fault at Channel 8	Line fault at channel 8 is reported only if there is NO short circuit and NO interruption on the same channel.

Description of the associated values

Number	Meaning	Data type
@1%d@	ID of the PN IO system	BYTE
@2%d@	Rack number	BYTE
@3%d@	Slot number	BYTE

4 Channel Modules

4.1 Notes on Using the Channel Modules

The channel modules are based on the Siemens APL standard and offer functionalities such as simulation, substitute values, and quality codes. These are described in more detail in the chapters on the individual channel modules.

The library contains five channel modules, enabling the use of all available submodules of the gateway.

- RIODiIn: digital inputs
- RIODiOu: digital outputs
- RIOAnIn: analog inputs
- RIOAnOu: analog outputs
- RIOCount: counter

The following table lists all submodules present in the GSDML and references the corresponding channel module.

Type	Submodule ID GSDML	I/O in bytes	Associated channel module
Digital Input (Submodules are distinguished by parameters)	0x01 0x02 0x03 0x04	1/0	RIODiIn
Digital Output (Submodules are distinguished by parameters and the fault bit "Linefault")	0x011 0x012 0x013	1/1	RIODiOu
Analog Input	0x21 0x22 (AI with HART option)	6/0	RIOAnIn
Analog Output	0x31 0x32 (AO with HART option)	5/4	RIOAnOu
Counter Input Frequency Input Frequency/Counter Input	0x41 0x42 0x43	6/5 7/0 11/5	RIOCount RIOAnIn RIOCount + RIOAnIn
RTD/Resist. Input predefined (5x04) TC/Voltage Input predefined (5x02, 5x05) Voltage Input predefined (5x06) RTD Input user defined (5x04) Resist. Input user defined (5x01, 5x04) RTD/Resist. Input predefined (5x01) RTD Input user defined (5x01) TC Input user defined (5x02, 5x05) Voltage Input user defined mV (5x02, 5x05) Voltage Input user defined (5x06)	0x51 0x52 0x53 0x54 0x55 0x56 0x57 0x58 0x59 0x5A	6/0	RIOAnIn
HART Dyn Var Pv HART Dyn Var PvSv HART Dyn Var PvSvTv HART Dyn Var PvSvTvQv HART Dyn Var Sv HART Dyn Var SvTv HART Dyn Var SvTvQv	0x61 0x62 0x63 0x64 0x65 0x66 0x67	5/0 9/0 13/0 17/0 5/0 9/0 13/0	Channel module of the corresponding AI/AO See 2.2.4

4.2 RIOAnIn—Analog Input Channel Module

This section contains information about the following topics:

- Description/functions of RIOAnIn
- RIOAnIn operating modes
- RIOAnIn troubleshooting
- RIOAnIn reporting
- RIOAnIn connections

4.2.1 Description/Functions of RIOAnIn

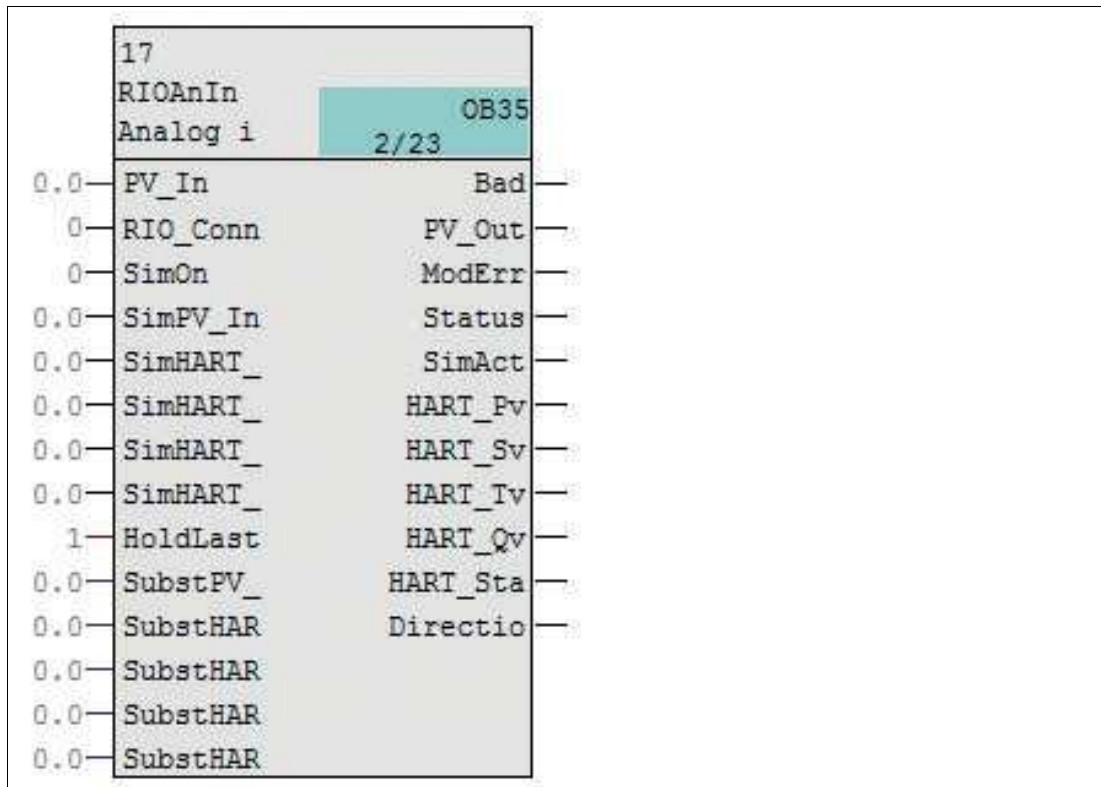

Figure 4.1 RIOAnIn channel module

For project planning, the RIOAnIn PV_In input must be connected to the process value of the desired submodule. This requires a REAL symbol to be created in the symbol table and linked with the input address of the process value (DWORD). The project planning of the channel modules is described in more detail in chapter 5.

The functions listed here are described in detail in chapter 2.2.

The RIOAnIn channel module reads the connected Real word32. If there is no fault, the process value read is output to "PV_Out." The diagnostic word of the connected module is read cyclically and output at the output "Status" as described in chapter 5.7. If a fault occurs, the output "Bad" is set to 1, which means that the process value is invalid. If there is a rack or module fault, "ModErr" and "Bad" are set to 1.

The channel module provides the option "HoldLastValue," which can be activated/deactivated via the input with the same name. If "HoldLastValue" is active ("HoldLastValue" = 1), the last valid process value at "PV_Out" is kept in the case of a fault (Bad = 1). If "HoldLastValue" is inactive ("HoldLastValue" = 0), the value input at "SubstPV_In," "SubstHART_PV," etc., is output at "PV_Out," "HART_PV," etc. in the case of a fault.

In simulation mode ("SimOn" = 1), the value input at "SimPV_In" is output at "PV_Out." The outputs "Status," "Bad," "ModErr," and "HART_Status" are set to 0 in simulation mode. The "SimAct" output is set to 1. The inputs "SimHART_Pv," "SimHART_Sv," etc., are passed to the respective outputs "HART_PV," "HART_Sv," etc.

If RIOAnIn is used in combination with a HART submodule, the channel module receives the logical input address of the HART submodule and its submodule ID via the structure "RIO_-Conn" (see 2.2.4). This information can help read the HART auxiliary variables including status byte, and output them at the corresponding outputs.

The scaling of the process value already takes place in the submodule itself.

The "Direction" output is only valid for the frequency module and outputs the submodule's cyclic input bit with the same name. For all other submodules, the output is always 0.

4.2.2 RIOAnIn Operating Modes

This module has no operating modes.

4.2.3 RIOAnIn Troubleshooting

The troubleshooting of the channel modules is described in chapter 4.7.

4.2.4 RIOAnIn Reporting

This module has no reporting behavior.

4.2.5 RIOAnIn Connections

RIOAnIn inputs

Input	Type	Start value	Visible	Description
EN	BOOL	1	-	1 = Activated module is processed
PV_In	REAL	0.0	X	Connection to process value
RIO_Conn	STRUCT	-	X	Contains information about the submodule. Connection to RIOMOD is automatically inserted by the driver wizard.
SimOn	BOOL + ST	0 16#80	X	1 = simulation switched on
SimPV_In	REAL + ST	0.0 16#80	-	Process value that is used when SimOn = 1
SimHART_Pv	REAL + ST	0.0 16#80	-	Value that is output when SimOn = 1 at HART_Pv
SimHART_Sv	REAL + ST	0.0 16#80	-	Value that is output when SimOn = 1 at HART_Sv
SimHART_Tv	REAL + ST	0.0 16#80	-	Value that is output when SimOn = 1 at HART_Tv
SimHART_Qv	REAL + ST	0.0 16#80	-	Value that is output when SimOn = 1 at HART_Qv
HoldLastValue	BOOL	1	X	1 = last process value is kept in case of a fault 0 = substitute value is used
SubsPV_In	REAL	0.0	-	This substitute value is output in the case of a fault at PV_Out, if HoldLastValue = 0
SubsHART_Pv	REAL	0.0	-	This substitute value is output in the case of a fault at HART_Pv, if HoldLastValue = 0
SubsHART_Sv	REAL	0.0	-	This substitute value is output in the case of a fault at HART_Sv, if HoldLastValue = 0
SubsHART_Tv	REAL	0.0	-	This substitute value is output in the case of a fault at HART_Tv, if HoldLastValue = 0
SubsHART_Qv	REAL	0.0	-	This substitute value is output in the case of a fault at HART_Qv, if HoldLastValue = 0

RIOAnIn outputs

Output	Type	Start value	Visible	Description
ENO	BOOL	0	-	1 = module algorithm is completed without any faults
Bad	BOOL + ST	0 16#80	X	1 = process value is invalid
PV_Out	REAL + ST	0.0 16#80	X	Process value
ModErr	BOOL + ST	0 16#80	-	1 = device/assembly is faulty
Status	WORD + ST	0 16#80	-	Status word, see 4.7
SimAct	BOOL + ST	0 16#80	-	1 = simulation active
HART_Pv	REAL + ST	0.0 16#80	-	HART auxiliary variable Pv
HART_Sv	REAL + ST	0.0 16#80	-	HART auxiliary variable Sv
HART_Tv	REAL + ST	0.0 16#80	-	HART auxiliary variable Tv
HART_Qv	REAL + ST	0.0 16#80	-	HART auxiliary variable Qv
HART_Stat- us	BYTE + ST	0 16#80	-	HART status byte
Direction	BOOL + ST	0 16#80	-	Only valid for frequency submodule. Outputs the cyclic input bit with the same name.

4.3 RIOAnOu—Analog Output Channel Module

This section contains information about the following topics:

- Description/functions of RIOAnOu
- RIOAnOu operating modes
- RIOAnOu troubleshooting
- RIOAnOu reporting
- RIOAnOu connections

4.3.1 Description/Functions of RIOAnOu

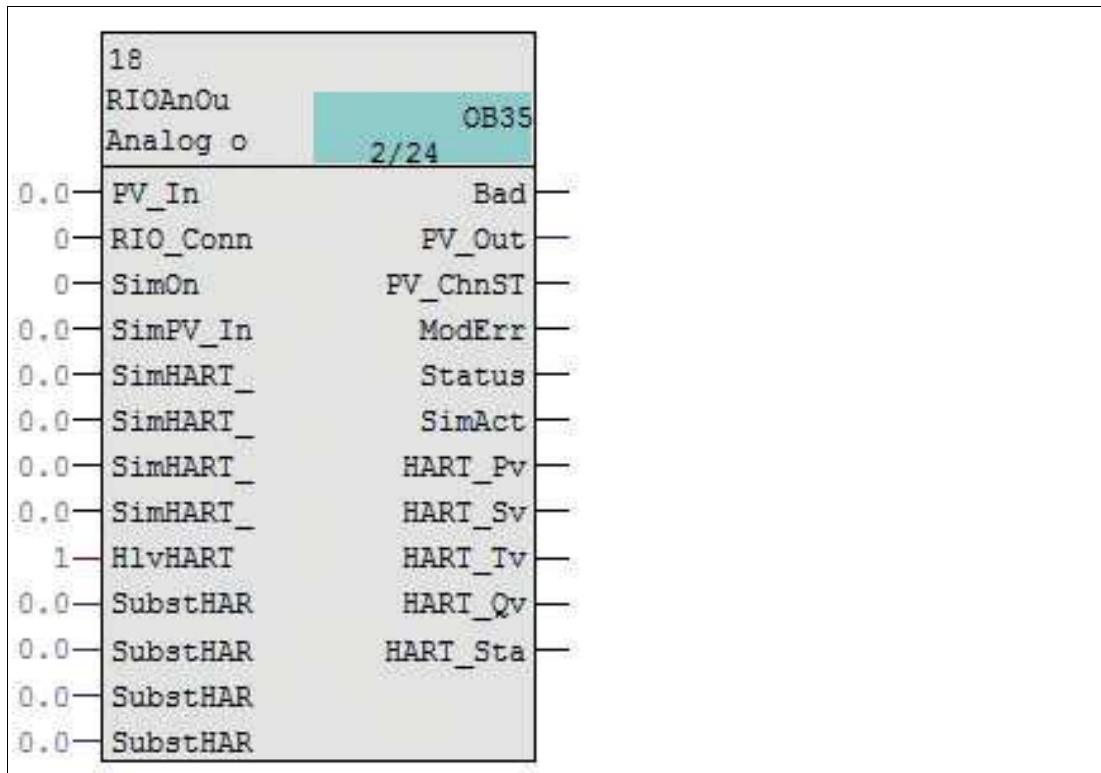

Figure 4.2 RIOAnOu channel module

For project planning, the RIOAnOu PV_Out output must be connected to the process value of the desired submodule. This requires a REAL symbol to be created in the symbol table and linked with the output address of the process value (DWORD). The project planning of the channel modules is described in more detail in chapter 5. The functions listed here are described in detail in chapter 2.2.

The RIOAnOu channel module writes the word32 connected at "PV_In" to the logical output address connected via "PV_Out." The channel module receives the logical input address of the associated submodule via the "RIO_Conn" structure. The diagnostic information of the submodule is read cyclically and the information it contains is output at the output "Status" as described in chapter 4.7. If "ModErr" = 1, "Bad" is set to 1.

The channel module provides the option "HoldLastValue" for HART variables, which can be activated/deactivated via the input "HlvHART." If "HlvHART" = 1, in the case of a fault (Bad = 1), the last valid values at the HART outputs are kept. If "HlvHART" is inactive, the value input at "SubstHART_Pv," "SubstHART_Sv," etc., is output at "HART_Pv," "HART_Sv," etc. in the case of a fault.

In simulation mode ("SimOn" = 1), the value input at "SimPV_In" is output at "PV_Out." The outputs "Status," "Bad," "ModErr," and "HART_Status" are set to 0 in simulation mode. The "SimAct" output is set to 1. The inputs "SimHART_Pv," "SimHART_Sv," etc., are passed to the respective outputs "HART_PV," "HART_Sv," etc.

If RIOAnOu is used in combination with a HART submodule, the channel module receives the logical input address of the HART submodule and its submodule ID via the structure "RIO_Conn" (see 2.2.4). This information can help read the HART auxiliary variables including status byte, and output them at the corresponding outputs.

4.3.2 RIOAnOu Operating Modes

This module has no operating modes.

4.3.3 RIOAnOu Troubleshooting

The troubleshooting of the channel modules is described in chapter 4.7.

4.3.4 RIOAnOu Reporting

This module has no reporting behavior.

4.3.5 RIOAnOu Connections

RIOAnOu inputs

Input	Type	Start value	Visible	Description
EN	BOOL	1	-	1 = Activated module is processed
PV_In	REAL + ST	0.0 16#80	X	Input value
RIO_Conn	STRUCT	-	X	Contains information about the submodule. Connection to RIOMOD is automatically inserted by the driver wizard.
SimOn	BOOL + ST	0 16#80	X	1 = simulation switched on
SimPV_In	REAL + ST	0.0 16#80	-	Process value that is used when SimOn = 1
SimHART_Pv	REAL + ST	0.0 16#80	-	Value that is output when SimOn = 1 at HART_Pv
SimHART_Sv	REAL + ST	0.0 16#80	-	Value that is output when SimOn = 1 at HART_Sv
SimHART_Tv	REAL + ST	0.0 16#80	-	Value that is output when SimOn = 1 at HART_Tv
SimHART_Qv	REAL + ST	0.0 16#80	-	Value that is output when SimOn = 1 at HART_Qv
HlvHART	BOOL	1	-	1 = last values of the HART outputs are kept in case of a fault. 0 = substitute value is used
SubsHART_Pv	REAL	0.0	-	This substitute value is output in the case of a fault at HART_Pv, if HlvHART = 0
SubsHART_Sv	REAL	0.0	-	This substitute value is output in the case of a fault at HART_Sv, if HlvHART = 0
SubsHART_Tv	REAL	0.0	-	This substitute value is output in the case of a fault at HART_Tv, if HlvHART = 0
SubsHART_Qv	REAL	0.0	-	This substitute value is output in the case of a fault at HART_Qv, if HlvHART = 0

RIOAnOu outputs

Output	Type	Start value	Visible	Description
ENO	BOOL	0	-	Enable Out
Bad	BOOL + ST	0 16#80	X	1 = process value is invalid
PV_Out	REAL	0.0	X	Connection to process value
ModErr	BOOL + ST	0 16#80	-	1 = device/assembly is faulty
Status	WORD + ST	0 16#80	-	Status word, see 4.7
PV_ChnST	REAL + ST	0.0 16#80	X	Signal status of the output channel and value of the PV_Out
SimAct	BOOL + ST	0 16#80	-	1 = simulation active
HART_Pv	REAL + ST	0.0 16#80	-	HART auxiliary variable Pv
HART_Sv	REAL + ST	0.0 16#80	-	HART auxiliary variable Sv
HART_Tv	REAL + ST	0.0 16#80	-	HART auxiliary variable Tv
HART_Qv	REAL + ST	0.0 16#80	-	HART auxiliary variable Qv
HART_Status	BYTE + ST	0 16#80	-	HART status byte

4.4 RIOCount—Analog Input Channel Module (Counter Modules)

This chapter contains information about the following topics:

- Description/Functions of RIOCount
- RIOCount operating modes
- RIOCount troubleshooting
- RIOCount reporting
- RIOCount connections

4.4.1 Description/Functions of RIOCount

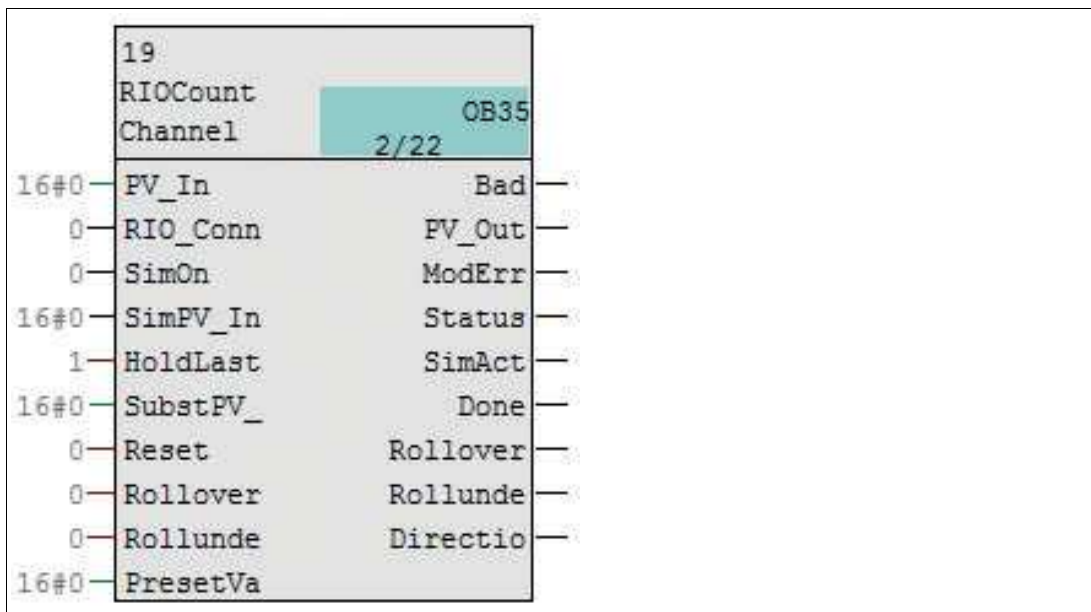

Figure 4.3 RIOCount channel module

For project planning, the PV_In input of RIOCount must be connected to the counter value of the desired DWORD type submodule. The project planning of the channel modules is described in more detail in chapter 5.

The functions listed here are described in detail in chapter 2.2.

The RIOCount channel module is used to read counter values and is used in the two submodules "Counter Input" (submodule ID: 0x41) and "Frequency/Counter Input" (submodule ID: 0x43). A RIOAnIn channel module is required for the "Frequency/Counter Input" module to read the frequency.

The diagnostic information of the submodule is read cyclically and the information it contains is output at the "Status" output as described in chapter 4.7 If "ModErr" = 1, "Bad" is set to 1.

Regardless of the submodule used, the logical input address of the counter value must be connected to PV_In. If there is no fault, the process value read is output to "PV_Out."

The inputs "Reset," "RolloverAck," "RollunderAck," and "PresetValue" are written cyclically to the associated logical output address.

The outputs "Done," "Rollover," "Rollunder," and "Direction" are read cyclically from the associated logical input addresses. In the case of a fault, the last valid value of these 4 outputs is kept.

The channel module provides the option "HoldLastValue," which can be activated/deactivated via the input with the same name. If "HoldLastValue" is active ("HoldLastValue" = 1), the last valid value at "PV_Out" is kept in the case of a fault (Bad = 1). If "HoldLastValue" is inactive ("HoldLastValue" = 0), the value input at "SubsPV_In" is output at "PV_Out" in the case of a fault."

In simulation mode ("SimOn" = 1), the value input at "SimPV_In" is output at "PV_Out." The outputs "Status," "Bad," and "SimAct" are set to 0 in simulation mode.

4.4.2 RIOCount Operating Modes

This module has no operating modes.

4.4.3 RIOCount Troubleshooting

The troubleshooting of the channel modules is described in chapter 4.7.

4.4.4 RIOCount Reporting

This module has no reporting behavior.

4.4.5 RIOCount Connections

RIOCount inputs

Input	Type	Start value	Visible	Description
EN	BOOL	1	-	Enable
PV_In	DWORD	0	X	Connection to the first input bit of the associated submodule.
RIO_Conn	STRUCT	-	X	Contains information about the submodule. Connection to RIOMOD is automatically inserted by the driver wizard.
SimOn	BOOL + ST	0 16#80	X	1 = simulation switched on
SimPV_In	DWORD + ST	0 16#80	X	Process value that is used when SimOn = 1
HoldLastValue	BOOL	0	X	1 = last process value is kept in case of a fault. 0 = substitute value is used
SubsPV_In	DWORD	0	-	This substitute value is output at PV_Out, if HoldLastValue = 0.
Reset	BOOL	0	X	This value is written directly to the cyclic output bit "Reset."
RolloverAck	BOOL	0	X	This value is written directly to the cyclic output bit "Rollover_Ack."
RollunderAck	BOOL	0	X	This value is written directly to the cyclic output bit "Rollunder_Ack."
PresetValue	DWORD	0	X	This value is written directly to the cyclic output word32 "PresetValue."

RIOCount outputs

Output	Type	Start value	Visible	Description
ENO	BOOL	0	-	Enable Out
Bad	BOOL + ST	0 16#80	X	1 = process value is invalid
PV_Out	DWORD + ST	0 16#80	X	Process value
ModErr	BOOL + ST	0 16#80	-	1 = device/assembly is faulty
Status	WORD + ST	0 16#80	-	Status word, see 4.7
SimAct	BOOL + ST	0 16#80	-	1 = simulation active
Done	BOOL + ST	0 16#80	X	Cyclic input bit "Done" is output here.
Rollover	BOOL + ST	0 16#80	X	Cyclic input bit "Rollover" is output here.
Rollunder	BOOL + ST	0 16#80	X	Cyclic input bit "Rollunder" is output here.
Direction	BOOL + ST	0 16#80	-	Cyclic input bit "Direction" is output here.

4.5 RIODiIn—Digital Input Channel Module

This chapter contains information about the following topics:

- Description/Functions of RIODiIn
- RIODiIn operating modes
- RIODiIn troubleshooting
- RIODiIn reporting
- RIODiIn connections

4.5.1 Description/Functions of RIODiIn

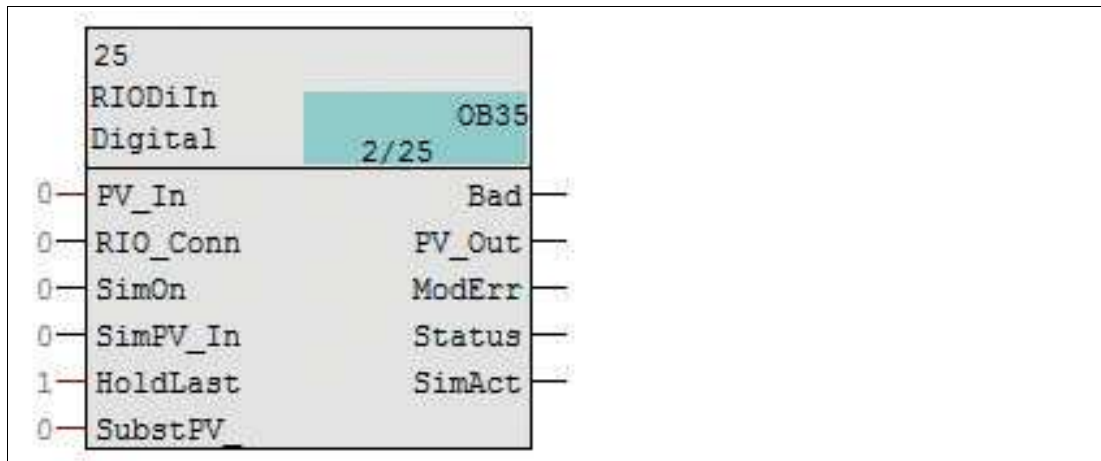

Figure 4.4 RIODiIn channel module

For project planning, the PV_In input of RIODiIn must be connected to the process value of the desired BOOL submodule. The project planning of the channel modules is described in more detail in chapter 5.

The functions listed here are described in detail in chapter 2.2.

The RIODiIn channel module reads the input bit connected at the PV_In input and outputs it at PV_Out if there is no fault. The diagnostic bits of the connected module are read and output at the output status as described in chapter 4.7. If a fault occurs, the output "Bad" is set to 1, which sets the quality code of all outputs to 16#00 "invalid value." If there is a rack or module fault, "ModErr" and "Bad" are set to 1.

The channel module provides the option "HoldLastValue," which can be activated/deactivated via the input with the same name. If "HoldLastValue" is active ("HoldLastValue" = 1), the last valid process value at "PV_Out" is kept in the case of a fault (Bad = 1). If "HoldLastValue" is inactive ("HoldLastValue" = 0), the value input at "SubstPV_In" is output at "PV_Out" in the case of a fault.

In simulation mode ("SimOn" = 1), the value input at "SimPV_In" is output at "PV_Out." The outputs "Status," "Bad," and "ModErr" are set to 0 in simulation mode. The "SimAct" output is set to 1.

4.5.2 RIODiIn Operating Modes

This module has no operating modes.

4.5.3 RIODiIn Troubleshooting

The troubleshooting of the channel modules is described in chapter 4.7.

4.5.4 RIODiIn Reporting

This module has no reporting behavior.

4.5.5 RIODiIn Connections

RIODiIn inputs

Input	Type	Start value	Visible	Description
EN	BOOL	1	-	1 = Activated module is processed
PV_In	BOOL	0	X	Connection to process value
RIO_Conn	STRUCT	-	X	Contains information about the submodule. Connection to RIOMOD is automatically inserted by the driver wizard.
SimOn	BOOL + ST	0 16#80	X	1 = simulation switched on
SimPV_In	BOOL + ST	0 16#80	X	Process value that is used when SimOn = 1
HoldLastValue	BOOL	1	X	1 = last process value is kept in case of a fault. 0 = substitute value is used
SubsPV_In	BOOL	0	-	This substitute value is output in the case of a fault at PV_Out, if HoldLastValue = 0.

RIODiIn outputs

Output	Type	Start value	Visible	Description
ENO	BOOL	0	-	1 = module algorithm is completed without any faults
Bad	BOOL + ST	0 16#80	X	1 = process value is invalid
PV_Out	BOOL + ST	0 16#80	X	Process value
ModErr	BOOL + ST	0 16#80	-	1 = device/assembly is faulty
Status	WORD + ST	0 16#80	-	Status word, see 4.7
SimAct	BOOL + ST	0 16#80	-	1 = simulation active

4.6 RIODiOu—Digital Output Channel Module

This chapter contains information about the following topics:

- Description/functions of RIODiOu
- RIODiOu operating modes
- RIODiOu troubleshooting
- RIODiOu reporting
- RIODiOu connections

4.6.1 Description/Functions of RIODiOu

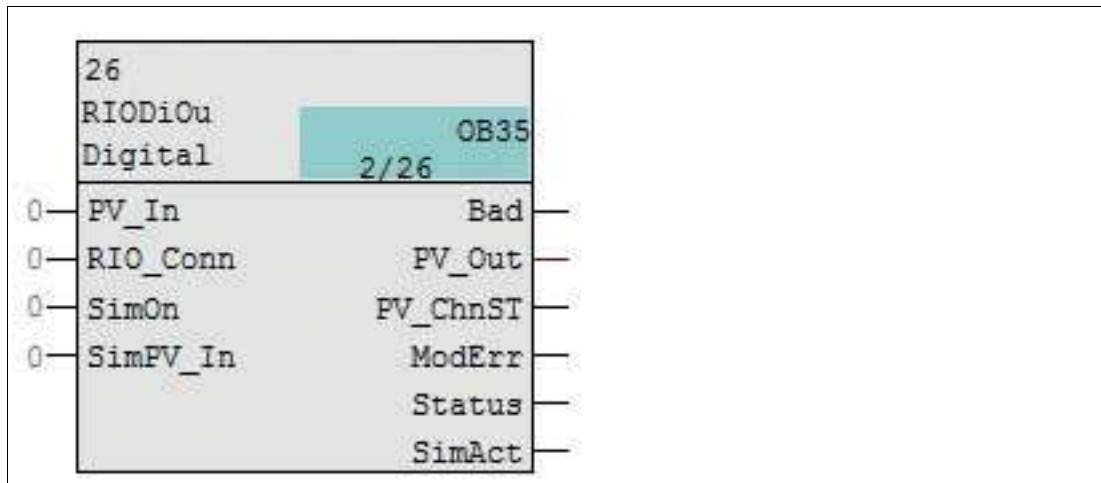

Figure 4.5 RIODiOu channel module

For project planning, the RIODiOu PV_Out output must be connected to the process value of the desired BOOL submodule. The project planning of the channel modules is described in more detail in chapter 5.

The functions listed here are described in detail in chapter 2.2.

The RIODiOu channel module writes the bit attached at "PV_In" to the logical address connected via "PV_Out." The channel module receives the logical input address of the associated submodule via the "RIO_Conn" structure. The input byte of the submodule is read cyclically and the status information it contains is output at the output Status as described in chapter 4.7. If "ModErr" = 1, "Bad" is set to 1.

In simulation mode ("SimOn" = 1), the value input at "SimPV_In" is output at "PV_Out." The outputs "Status," "Bad," and "ModErr" are set to 0 in simulation mode. The "SimAct" output is set to 1.

4.6.2 RIODiOu Operating Modes

This module has no operating modes.

4.6.3 RIODiOu Troubleshooting

The troubleshooting of the channel modules is described in chapter 4.7.

4.6.4 RIODiOu Reporting

This module has no reporting behavior.

4.6.5 RIODiOu Connections

RIODiOu inputs

Input	Type	Start value	Visible	Description
EN	BOOL	1	-	1 = Activated module is processed
PV_In	BOOL	0	X	Input value
RIO_Conn	STRUCT	-	X	Contains information about the sub-module. Connection to RIOMOD is automatically inserted by the driver wizard.
SimOn	BOOL + ST	0 16#80	X	1 = simulation switched on
SimPV_In	BOOL + ST	0 16#80	X	Process value that is used when SimOn = 1

RIODiOu outputs

Output	Type	Start value	Visible	Description
ENO	BOOL	0	-	1 = module algorithm is completed without any faults
Bad	BOOL + ST	0 16#80	X	1 = process value is invalid
PV_Out	BOOL	0	X	Connection to process value
PV_ChnST	BOOL + ST	0 16#80	X	Signal status of the output channel and value of PV_Out
ModErr	BOOL + ST	0 16#80	-	1 = device/assembly is faulty
Status	WORD + ST	0	-	Status word, see 4.7
SimAct	BOOL + ST	0 16#80	-	1 = simulation active

4.7 Troubleshooting

The channel modules output the cyclic diagnostic data of the submodules at the "Status" output and, if necessary, via the "Status_HART" output. Sending messages to the PCS 7 reporting system is handled by RIOMOD (see chapter 3.3).

In addition to the cyclic diagnosis, the following faults are handled:

- Examination of the submodule ID, whether the connected submodule is known to the channel module, and whether it is supported. E.g.: fault in interconnection of an analog output to RIOAnIn.
- Fault when reading the cyclic diagnosis data using "BLKMOV" (SFB20).

The following two tables show the byte order and the structure of the status output. The structure and the byte order are the same for all channel modules. The column "Bad = true" indicates whether the corresponding diagnostic message sets the "Bad" output of the channel module to "true," and thus marks the process value as invalid. Not all submodules have all diagnostic bits. If a diagnostic bit of a submodule is not provided, its value is set to 0.

Output word "Status"—byte order

Byte 0								Byte 1							
7	6	5	4	3	2	1	0	7	6	5	4	3	2	1	0

Output word "Status"—structure

Byte	Bit	Name	Bad = true
0	0	Not used	-
0	1	Fault	X
0	2	Line Fault	X
0	3	Not used	-
0	4	Open Wire	X
0	5	Short Circuit	X
0	6	Simulation Active	-
0	7	Not used	-
1	0	Over Range	-
1	1	Under Range	-
1	2	High High Alarm	-
1	3	High Alarm	-
1	4	LowAlarm	-
1	5	Low Low Alarm	-
1	6	The connected submodule is not supported by the channel module.	X
1	7	Fault when reading/writing cyclic data using "BLKMOV" (SFB20)	X

The status of HART submodules is output at the "HART_Status" output of the channel module. The HART diagnostics have no effect on the "Bad" output or the quality code of the HART outputs. If, however, there is a fault when reading the cyclic data of the HART submodule using "BLKMOV" (SFB20), 16#FF is output at HART_Status and the quality code of all HART outputs is set to 16#0 (Invalid value).

Output byte HART_Status—structure

Byte	Bit	Name
0	0	Non Primary Variable out of Limits
0	1	Primary Variable out of Limits
0	2	Analog Output Saturated
0	3	Analog Output Fixed
0	4	More Status Available
0	5	Cold Start
0	6	Configuration Changed
0	7	Field Device Malfunction

5 Project Planning

5.1 HW Config

For the project planning of the channel modules, the gateway, including all the modules and submodules used, must first be installed in HW Config and parameterized as desired. The GSDML file must be imported beforehand. The supported version of the GSDML file is listed in chapter 2.1.3.

Steckplatz	Baugruppe	Bestellnumm...	E-Adresse	A-Adresse	Diagnoseadresse
0	LB-8122				16361*
X1	FN-IO				16360*
X1 P1	Port 1 - RJ45				16359*
X1 P2	Port 2 - RJ45				16358*
1	3x05 - Analog Input (4A~)				0*
Channel 1	Analog Input		0..5		
Channel 2	Analog Input		6..11		
Channel 3	Analog Input		12..17		
Channel 4	Analog Input		18..23		
HART Channel 1	HART Dyn Var Pv Sv Tv Qv		191...207		
HART Channel 2	HART Dyn Var Pv Sv		219..227		
HART Channel 3	HART Dyn Var Sv		208...212		
HART Channel 4	HART Dyn Var Sv Tv Qv		228...240		
2					
3	6x17 - Digital Output (~)				13**
Channel 1	Digital Output		41	13	
Channel 2	Digital Output		215	14	
4	2x17 - Solenoid Driver ~				15**
Channel 1	Digital Output		218	15	
Channel 2	Digital Input		216		
Channel 3	Digital Input		217		

Figure 5.1 Gateway in HW Config



Creating a symbol table

The process outlined here shows how to modify or redefine symbols via dialog boxes when compiling your submodules in the project.

From the configuration table, select the submodule to which you wish to assign a symbol. Right-click on the desired submodule and select "Edit Symbols" from the dialog box.

↳ The input window for the selected submodule opens. In the following figure, the symbol "ED645_Value" has been created, which is connected with the input word32 "ED645."

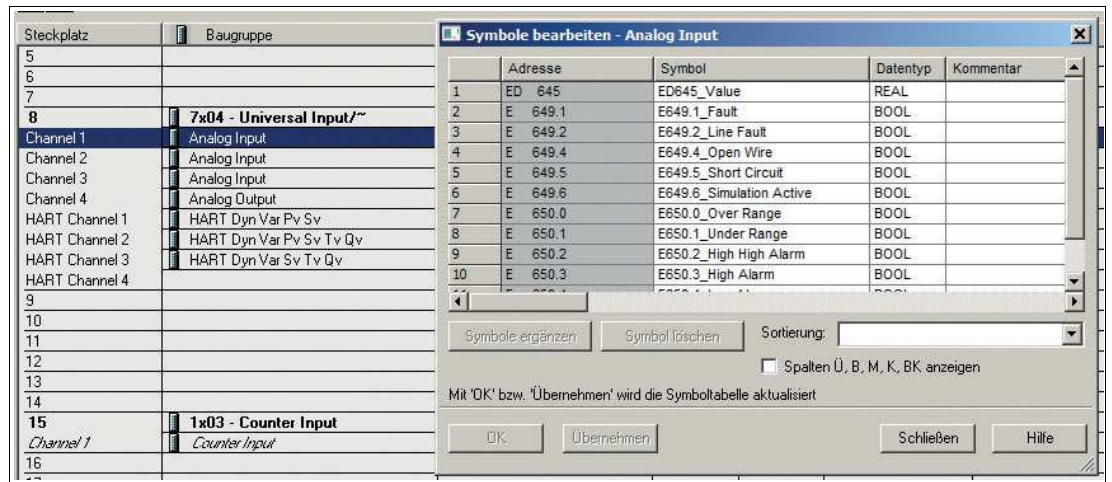

Figure 5.2 Creating symbols



Note

The symbols created in this way appear in the symbol table after compiling as shown in the following figure. Symbols can also be created directly in the symbol table and linked with any address. It is important that the data type matches. For example, to use the RIOAnIn analog input driver, the PV_IN input must be connected to the input word32 of the submodule process value and "REAL" has to be selected as the data type. Therefore, RIOAnIn cannot be directly connected to a word32 in the CFC plan that is not linked to a "REAL" data type symbol.

Status	Symbol	Adresse	Datentyp	Kommentar
	ED621_Value	ED 621	REAL	
	ED645_Value	ED 645	REAL	
	ED656_Value	ED 656	REAL	
	ED671_Value	ED 671	REAL	
	ED707_Counter Value	ED 707	DWORD	

Figure 5.3 Symbols in the symbol table

5.2 CFC

In the CFC plan, the channel module can be connected with the desired symbol by right-clicking on "PV_In" > "Interconnection to operand."

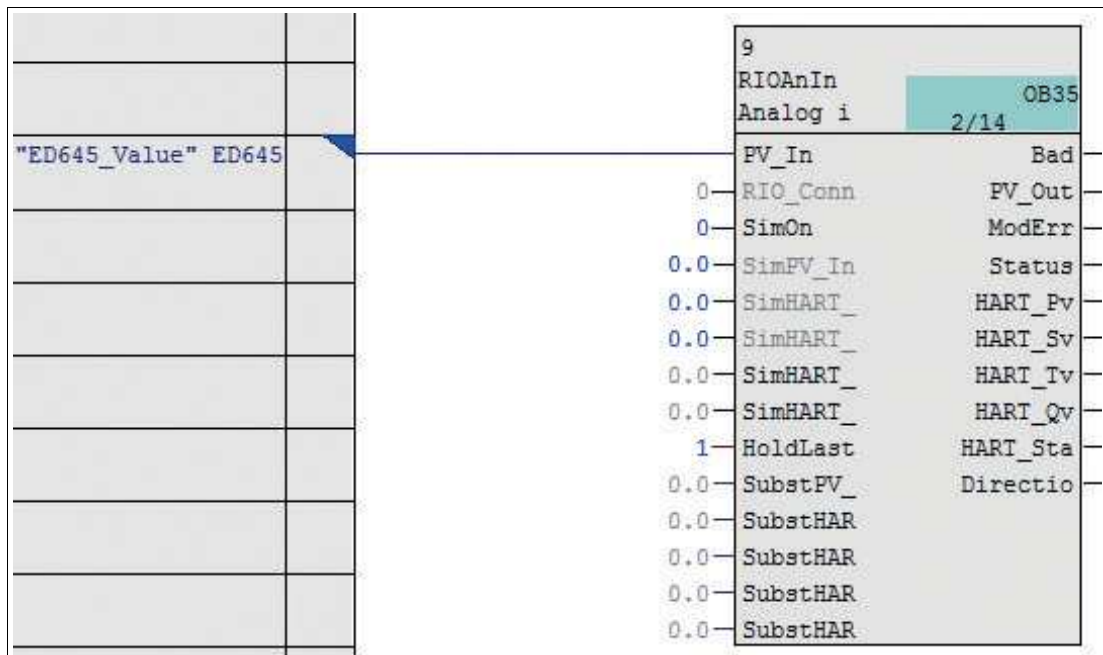

Figure 5.4 Interconnection of a channel module with a symbol

By compiling with the selected option "generate module driver," the driver wizard is run, which automatically inserts all the necessary modules and interconnections in the @ plans, and connects the "RIO_Conn" input of the channel module with the corresponding module.

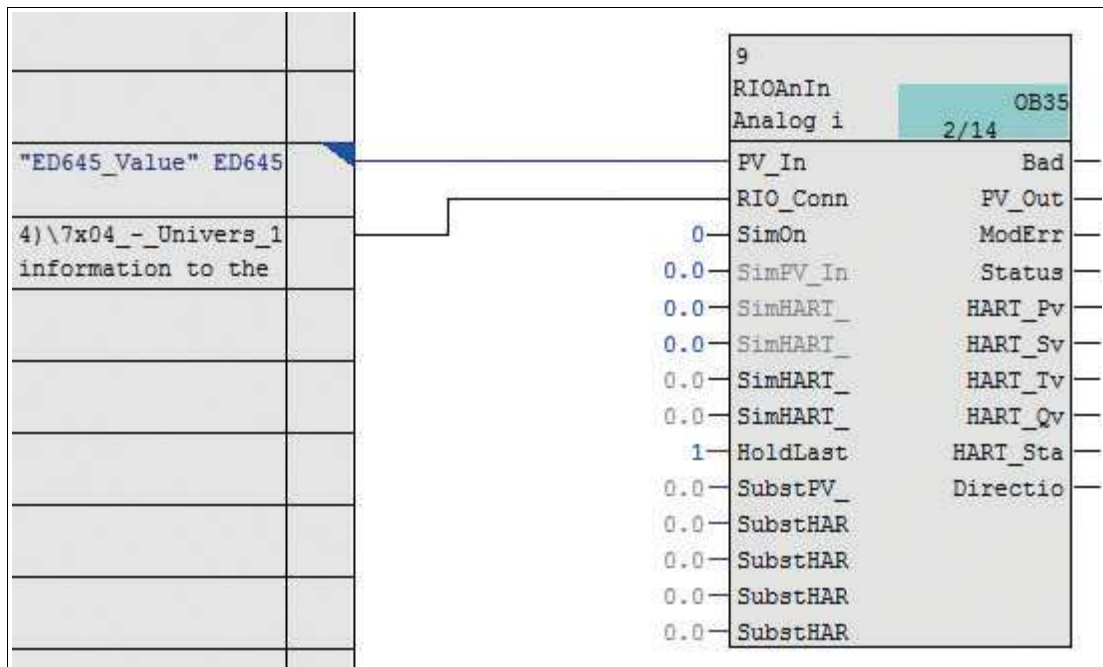

Figure 5.5 The "RIO_Conn" input was connected with the associated module via the driver wizard

This procedure is the same for all channel modules. This means "PV_In" (or "PV_Out" for RIODiOu and RIOAnOu) must be connected to the process value of the desired submodule and all additional modules and links are inserted by the driver wizard.

Your automation, our passion.

Explosion Protection

- Intrinsic Safety Barriers
- Signal Conditioners
- FieldConnex® Fieldbus
- Remote I/O Systems
- Electrical Ex Equipment
- Purge and Pressurization
- Industrial HMI
- Mobile Computing and Communications
- HART Interface Solutions
- Surge Protection
- Wireless Solutions
- Level Measurement

Industrial Sensors

- Proximity Sensors
- Photoelectric Sensors
- Industrial Vision
- Ultrasonic Sensors
- Rotary Encoders
- Positioning Systems
- Inclination and Acceleration Sensors
- Fieldbus Modules
- AS-Interface
- Identification Systems
- Displays and Signal Processing
- Connectivity

Pepperl+Fuchs Quality

Download our latest policy here:

www.pepperl-fuchs.com/quality

