

PGV100-F200A-B25-V1D

Incident Light Positioning System

Manual



EtherNet/IP™

Your automation, our passion.

 **PEPPERL+FUCHS**

With regard to the supply of products, the current issue of the following document is applicable: The General Terms of Delivery for Products and Services of the Electrical Industry, published by the Central Association of the Electrical Industry (Zentralverband Elektrotechnik und Elektroindustrie (ZVEI) e.V.) in its most recent version as well as the supplementary clause: "Expanded reservation of proprietorship"

Worldwide

Pepperl+Fuchs Group
Lilienthalstr. 200
68307 Mannheim
Germany
Phone: +49 621 776 - 0
E-mail: info@de.pepperl-fuchs.com

North American Headquarters

Pepperl+Fuchs Inc.
1600 Enterprise Parkway
Twinsburg, Ohio 44087
USA
Phone: +1 330 425-3555
E-mail: sales@us.pepperl-fuchs.com

Asia Headquarters

Pepperl+Fuchs Pte. Ltd.
P+F Building
18 Ayer Rajah Crescent
Singapore 139942
Phone: +65 6779-9091
E-mail: sales@sg.pepperl-fuchs.com
<https://www.pepperl-fuchs.com>

1	Introduction.....	4
1.1	Content of this Document.....	4
1.2	Target Group, Personnel	4
1.3	Symbols Used	5
2	Product Description	6
2.1	Use and Application	6
2.2	LED Indicators and Operating Elements.....	8
2.3	Accessories.....	9
3	Installation.....	10
3.1	Mounting the Read Head.....	10
3.2	Mounting the Colored Tape and Code Tape	12
3.3	Electrical connection.....	30
3.4	EtherNet/IP Connection	32
4	Commissioning.....	33
4.1	Direction Decision	33
5	Communication via EtherNet/IP	36
5.1	General Information on Communication via EtherNet/IP	36
5.2	Setting the IP Address	37
5.3	EtherNet/IP Objects	40
5.4	EtherNet/IP Connections	43
5.5	Overview of the Attributes of EtherNet/IP Objects.....	45
5.6	Description of the Attributes of EtherNet/IP Objects	46
6	Appendix	53
6.1	ASCII table.....	53

1 Introduction

1.1 Content of this Document

This document contains information required to use the product in the relevant phases of the product life cycle. This may include information on the following:

- Product identification
- Delivery, transport, and storage
- Mounting and installation
- Commissioning and operation
- Maintenance and repair
- Troubleshooting
- Dismounting
- Disposal



Note

For full information on the product, refer to the further documentation on the Internet at www.pepperl-fuchs.com.

The documentation comprises the following parts:

- This document
- Datasheet

In addition, the documentation may comprise the following parts, if applicable:

- EU-type examination certificate
- EU declaration of conformity
- Attestation of conformity
- Certificates
- Control drawings
- Instruction manual
- Other documents

1.2 Target Group, Personnel

Responsibility for planning, assembly, commissioning, operation, maintenance, and dismounting lies with the plant operator.

Only appropriately trained and qualified personnel may carry out mounting, installation, commissioning, operation, maintenance, and dismounting of the product. The personnel must have read and understood the instruction manual and the further documentation.

Prior to using the product make yourself familiar with it. Read the document carefully.

1.3 Symbols Used

This document contains symbols for the identification of warning messages and of informative messages.

Warning Messages

You will find warning messages, whenever dangers may arise from your actions. It is mandatory that you observe these warning messages for your personal safety and in order to avoid property damage.

Depending on the risk level, the warning messages are displayed in descending order as follows:



Danger!

This symbol indicates an imminent danger.

Non-observance will result in personal injury or death.



Warning!

This symbol indicates a possible fault or danger.

Non-observance may cause personal injury or serious property damage.



Caution!

This symbol indicates a possible fault.

Non-observance could interrupt the device and any connected systems and plants, or result in their complete failure.

Informative Symbols



Note

This symbol brings important information to your attention.



Action

This symbol indicates a paragraph with instructions. You are prompted to perform an action or a sequence of actions.

2 Product Description

2.1 Use and Application

Intended Use

This device, when used together with a colored tape affixed to the floor and code tapes printed with Data Matrix codes, constitute a high-resolution lane tracking and positioning system. It can be used in all applications where automated guided vehicles (AGV) are to be positioned precisely at marked positions along a given lane.

The read head forms part of the positioning system in the Pepperl+Fuchs incident light process. The read head's features include a camera module and an integrated illumination unit. The read head uses these features to detect a colored tape stuck to the floor or a painted color lane to track the lane. The read head detects Data Matrix tags to navigate within a grid. The read head also detects control codes and position markers in the form of Data Matrix codes printed on a self-adhesive code tape. Data Matrix code tapes and Data Matrix tags have priority over colored tapes or colored lanes.

The Data Matrix code tapes are installed in a fixed position instead of or along with the colored tape. The read head is located on an automated guided vehicle (AGV) and guides this vehicle along the colored tape.

Note

Priority

Data Matrix code tapes and Data Matrix tags have priority over colored tapes or colored lanes.

If the read head detects a Data Matrix code tape or Data Matrix tags in the field of view, colored tapes or colored lanes in the field of view are ignored.

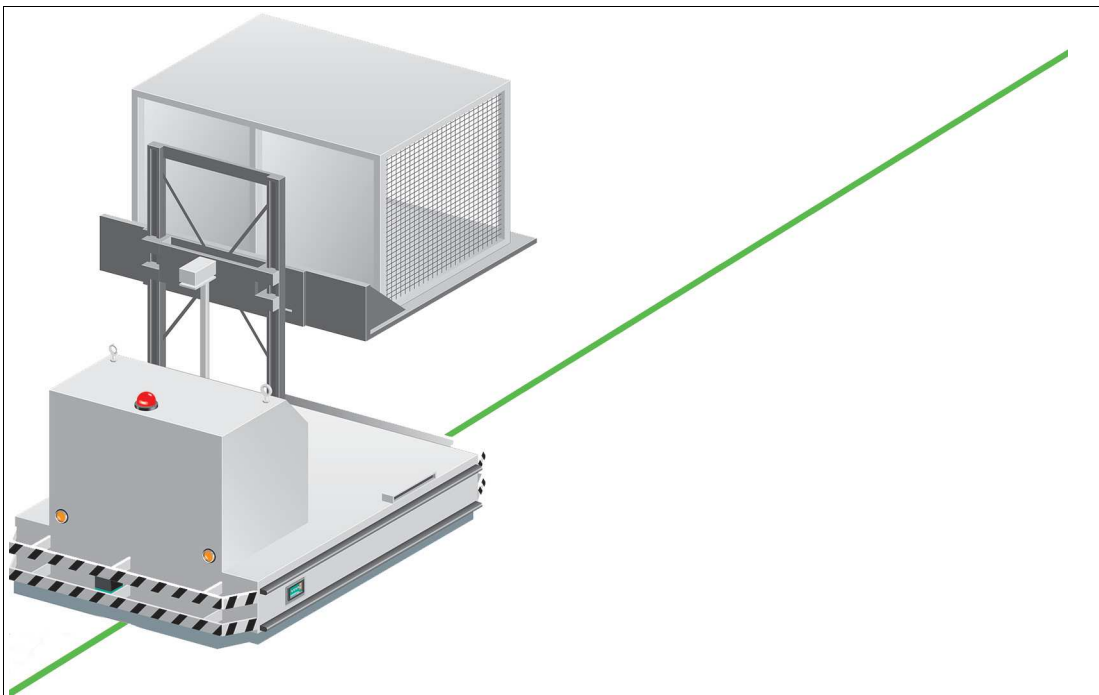

Figure 2.1 Automated guided vehicle with green colored tape

Tag Mode

In addition to the tracking, you can use the read head in tag mode. The read head detects Data Matrix tags, which are typically glued onto the floor in a grid. The individual Data Matrix tags are numbered consecutively and include position information. The read head reports the position of the AGV in relation to the zero point of the Data Matrix tag to the controller.

The tag mode allows the AGV to move freely in as large a grid as desired, without having to mark the crossing paths with lane tapes.

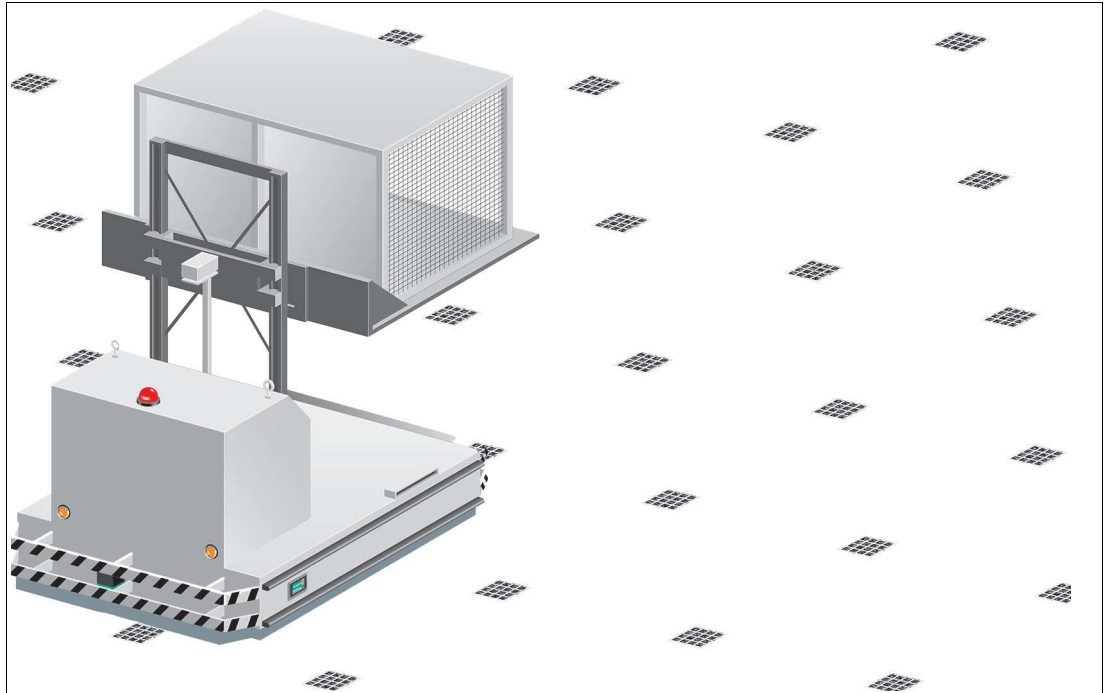

Figure 2.2 Automated guided vehicle with Data Matrix tags

The read head switches automatically between tag mode and lane tracking. This allows an automated guided vehicle to be guided from one Data Matrix tag grid via a colored or Data Matrix lane to another Data Matrix tag grid.

The extensive yet user-friendly parameterization options as well as the configurable inputs and outputs mean that the read head can easily be adapted to suit each application.

2.2 LED Indicators and Operating Elements

The read head has six indicator LEDs for carrying out visual function checks and quick diagnosis.

Activate the alignment aid and parameterization mode using the two control buttons on the back of the device.

Button 1 is labeled "ADJUST." Button 2 is labeled "CONFIG."

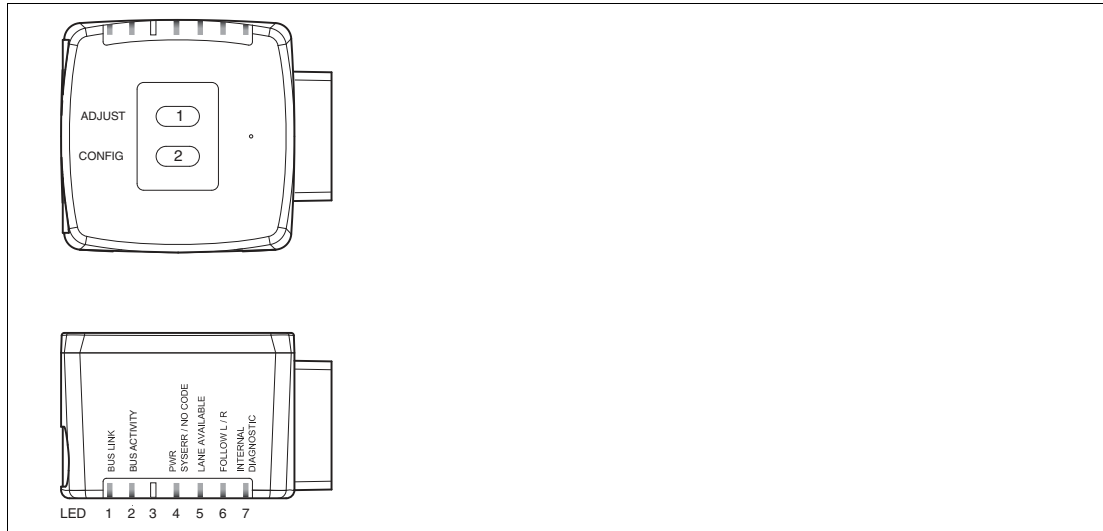

Figure 2.3 Overview of LED indicators and controls

LED	[#1] BUS LINK	[#2] BUS ACTIVITY	[#3] No function	[#4] PWR SYSERR/NO CODE	[#5] LANE AVAILABLE	[#6] FOLLOW L/R	[#7] INTERNAL DIAGNOSTIC	Description
Color	Green	Yellow	-	Green/red	Yellow	Yellow	Red/green/ yellow	
State	Lights up	x	-	x	x	x	x	Connection active
	x ¹	Flashing	-	x	x	x	x	Data transfer
	x	x	-	x	x	x	x	Communication errors
	x	x	-	x	x	x	x	No communication error
	x	x	-	Lights up red	x	x	x	System error
	x	x	-	Lights up green	x	x	x	Code detected
	x	x	-	Off	Flashing	x	x	Code not detected
	x	x	-	x	Lights up	x	x	Tape detected
	x	x	-	x	x	Lights up	x	Direction selection active

Table 2.1 Description of LED status

1. x = LED status has no meaning

Device switched on: at least one LED is switched on or flashing.

2.3 Accessories

Compatible accessories offer enormous potential for cost savings. Such accessories not only save you a great deal of time and effort when commissioning for the first time, but also when replacing and servicing our products.

If products are used in harsh ambient conditions, appropriate Pepperl+Fuchs accessories can be used to extend the service life of these products.

Model number	Description
V19-G-ABG-PG9-FE	Grounding terminal and plug (set)
PCV-SC12	Grounding clip
V1SD-G-*M-PUR-ABG-V1SD-G	Bus cable, M12 to M12, available in several different lengths
PCV-AG100	Alignment guide for reader
V19-G-*M-*	Configurable connection cable ¹
PCV-CM20-0*	Event marker
PCV-MB1	Mounting bracket for reader
V19-G-*M-PUR-ABG	Single-ended female cordset, M12, 8-pin, shielded, PUR cable
PCV-LM25	Marker head for code tape
PGV33M-CB19-*	PGV colored tape
PCV-KBL-V19-STR-USB	USB cable unit with power supply

1. Ask your contact person at Pepperl+Fuchs

3 Installation

3.1 Mounting the Read Head

Mount the PGV... read head on the automated guided vehicle using the four screws on the mounting adapter on the read head. Mount the read head in such a way that the lens with the ring light and camera module are directed toward the colored tape.

The mounting must be stable enough so that the read head does not leave its depth of focus range during operation.

The distance between the read head and the floor should be the same as the read distance of the read head.

Optimal Read Distance

Model number	Read distance [mm]	Depth of focus [mm]	Field of view (w x h) [mm]
PGV100*	100	± 20	117 x 75

Table 3.1 Read distance

Hysteresis

If the read head has detected a colored tape, this colored tape can move in the Y direction from the zero point within the viewing window. The maximum Y value at which the read head can still capture this distance is designated as **Y Value Out** in the following table.

If the read head swivels onto a colored tape, the read head can capture the distance of the colored tape from the zero point only if the tape is less than a certain distance away from the zero point. This distance is designated as **Y Value In** in the following table. The difference between Y Value Out and Y Value In is the hysteresis. See "Distance Output" on page 16.

Model number	Max. Y Value Out [mm]	Min. Y Value In [mm]
PGV100*	60	45

Table 3.2 Distance to zero point

Read Head Dimensions

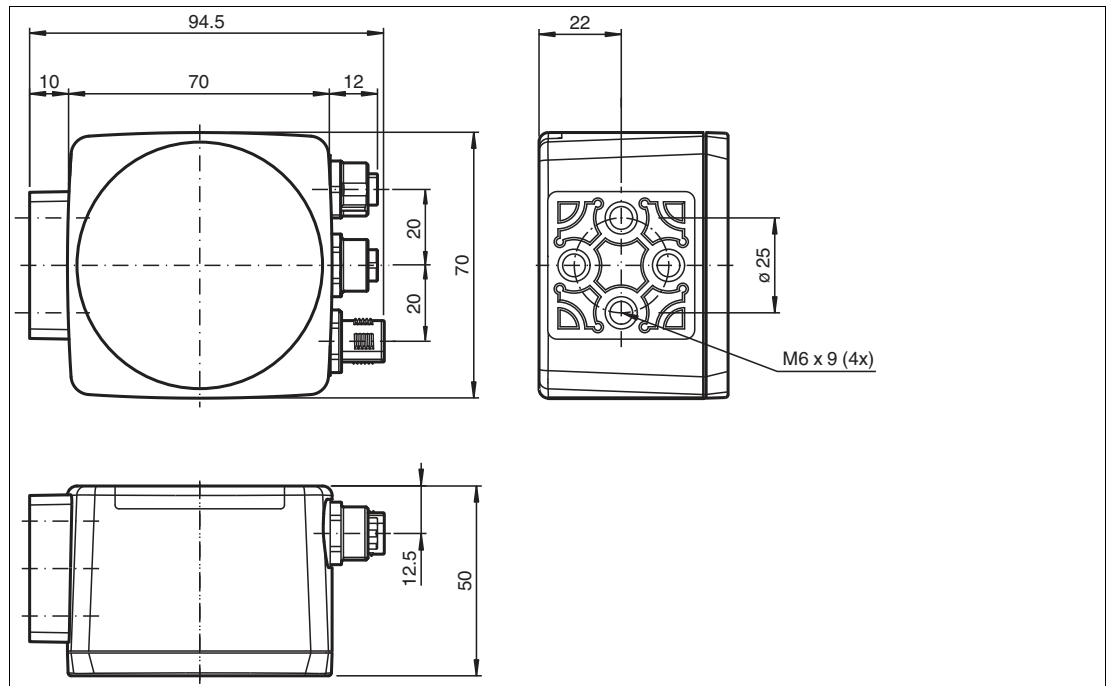

Figure 3.1 Dimensions



Caution!

When selecting the length of the mounting screws, ensure that the maximum insertion depth of the screws in the threaded inserts on the read head is 8 mm.

Using longer screws may damage the read head.



Caution!

The maximum torque of the mounting screws must not exceed 9 Nm.

Tightening the screws to a higher torque may damage the read head.

3.2 Mounting the Colored Tape and Code Tape

Colored tape

The colored tape must be flexible, conformable, and resistant to abrasion, with a matte finish.

The colored tape must meet the following specifications:

- Tape width: 10 mm ... 40 mm
- Color of the tape
 - Blue = RAL 5015
 - Green = RAL 6032
 - Red = RAL 3001
- Tape thickness > 0.1 mm
The thickness of the tape is irrelevant to read head operation.
- Breaking load > 25 N/cm
- Breaking elongation > 180%
- Adhesive strength > 2 N/cm
- Temperature resistance: -20 °C ... 70 °C

Secure the colored tape to the floor such that the following conditions are met:

- Data Matrix code tapes for positioning are used instead of the colored tape.
- Data Matrix control codes are positioned parallel to the colored tape.

Color Selection

Select the color of the colored tape so that the contrast between the floor color and the color of the colored tape is as great as possible. Ideally, use the complementary color.

Due to the integrated lighting of the read head, some floor colors appear to be different in the camera. If you have problems with the color selection of the colored tapes, please consult your contact at Pepperl+Fuchs.



Mounting the Colored Tape

1. Clean the surface of any greasy or oily deposits and dust.
2. Ensure that the surface is dry, clean, and stable.
3. Please observe the following section "Basics" when mounting the colored tape and, if necessary, the instructions from the colored tape manufacturer.



Note

Priority

Data Matrix code tapes and Data Matrix tags have priority over colored tapes or colored lanes.

If the read head detects a Data Matrix code tape or Data Matrix tags in the field of view, colored tapes or colored lanes in the field of view are ignored.

Cleaning Colored Tape/Code Tape

Significant contamination on the colored or code tapes can impair the detection by the read head. Clean the colored and code tapes with isopropanol if necessary. If the contamination is severe, you can use a non-corrosive plastic cleaner, e.g., Caramba®.



Note

To avoid polishing the surface, do not apply strong pressure when cleaning. A shiny surface of the colored or code tapes leads to impairment in detection by the read head.

Basics

The read head detects a colored tape on a floor as a lane. The width of the colored tape must be between 10 mm and 40 mm; the default width is 18 mm. The zero point is located in the center of the colored tape. You can use 3 defined colors. See the section entitled "Colored tape"

The sensor always moves in the X direction. In the sensor's field of view, X indicates an upward movement.



Figure 3.2 Field of view and coordinates of the sensor

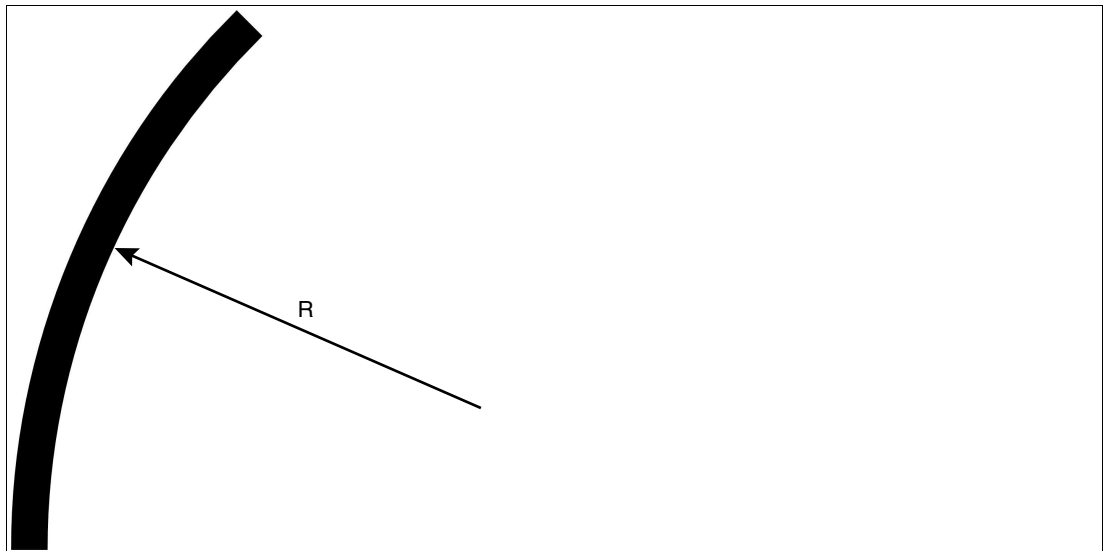

Figure 3.3 Curve radius: $R \geq 50$ cm

Select a curve radius that can handle the turning circle of your automated guided vehicle. The colored tape must always be located in the reading window of the read head.

Angle Output



Note

Angles are specified as absolute values. The respective value is calculated from the resolution selected under "Angle Resolution". With a resolution of 0.1° , an angle of 60° is output as $60^\circ/0.1^\circ = 600$.

The read head detects a change of the angle of the colored tape and the Data Matrix code tape and outputs this value to the controller. The output value is different for colored tapes and Data Matrix code tapes.

Colored tape

The read head detects the angle in relation to the tracked lane with a resolution of 360 (corresponds to 1°). The angle is specified relative to the tracked lane because a colored tape does not include any direction information. The output angle covers the range from -45° to 45° . The resolution is 1° .

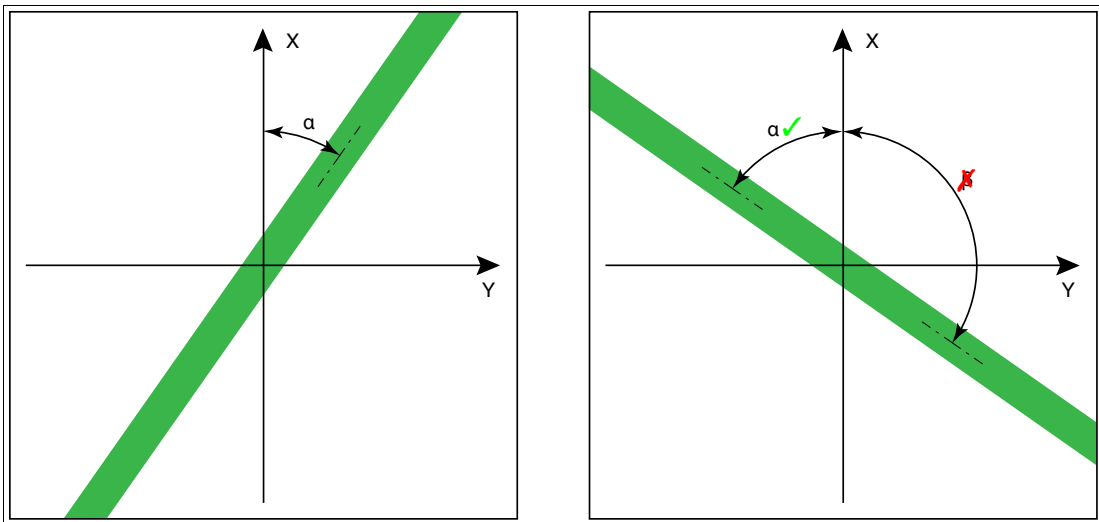

Figure 3.4 Relative angle

Data Matrix code tape

The read head detects the absolute angle in relation to the tracked lane with a maximum resolution of 0.1° . The angle is specified absolutely relative to the tracked lane, since a Data Matrix code contains tape direction information. The output angle covers the range from 0° to 360° . The resolution can be set to the following values:

- 0.1°
- 0.2°
- 0.5°
- 1°

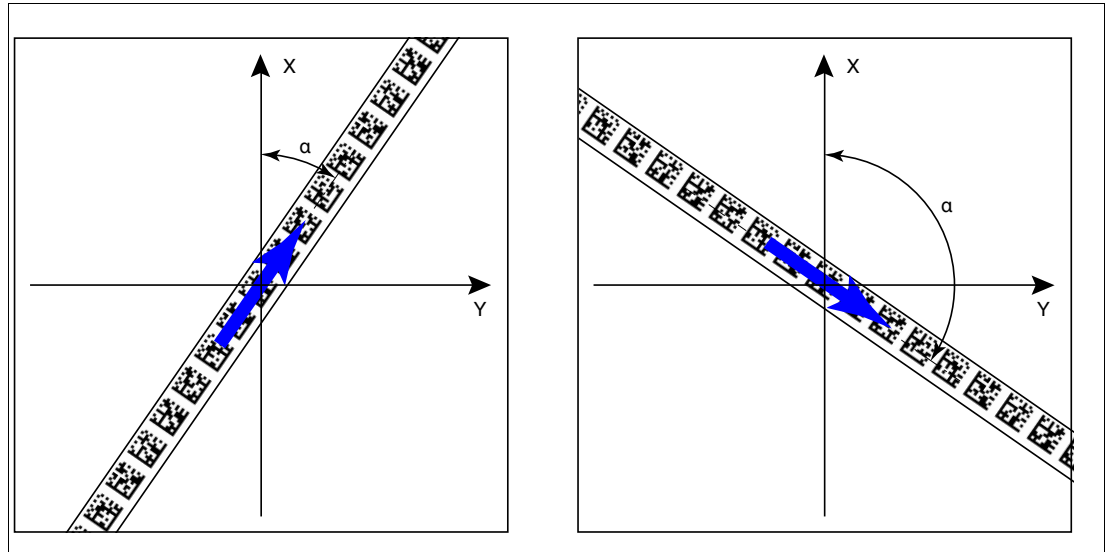

Figure 3.5 Absolute angle

Distance Output

The read head detects the distance from the zero point in the Y direction of a colored tape or a Data Matrix code tape and outputs this value to the controller. The output value is different for colored tapes and Data Matrix code tapes due to the lack of an X position for colored tapes.

Colored tape

The read head outputs the Y value at which the colored tape intersects the Y axis as the distance.

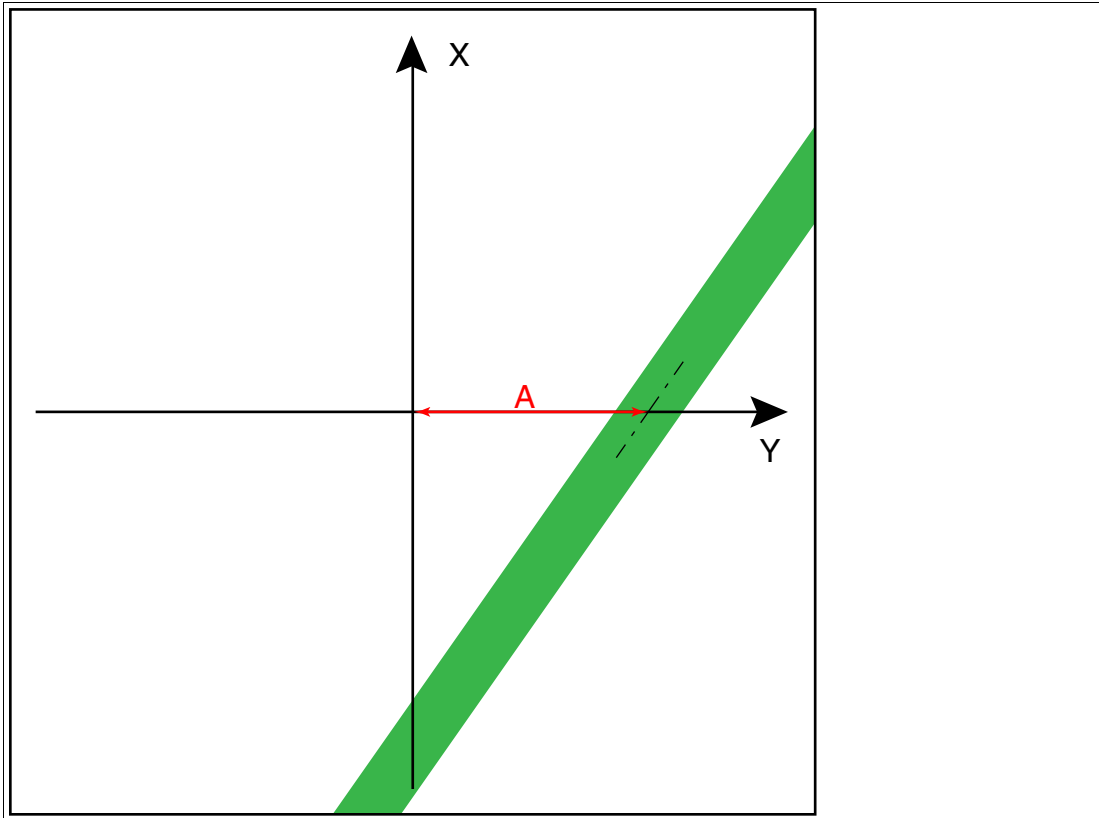

Figure 3.6 Distance A for colored tape

Data Matrix code tape

The read head indicates the vertical distance of the zero point in relation to the Data Matrix code tape.

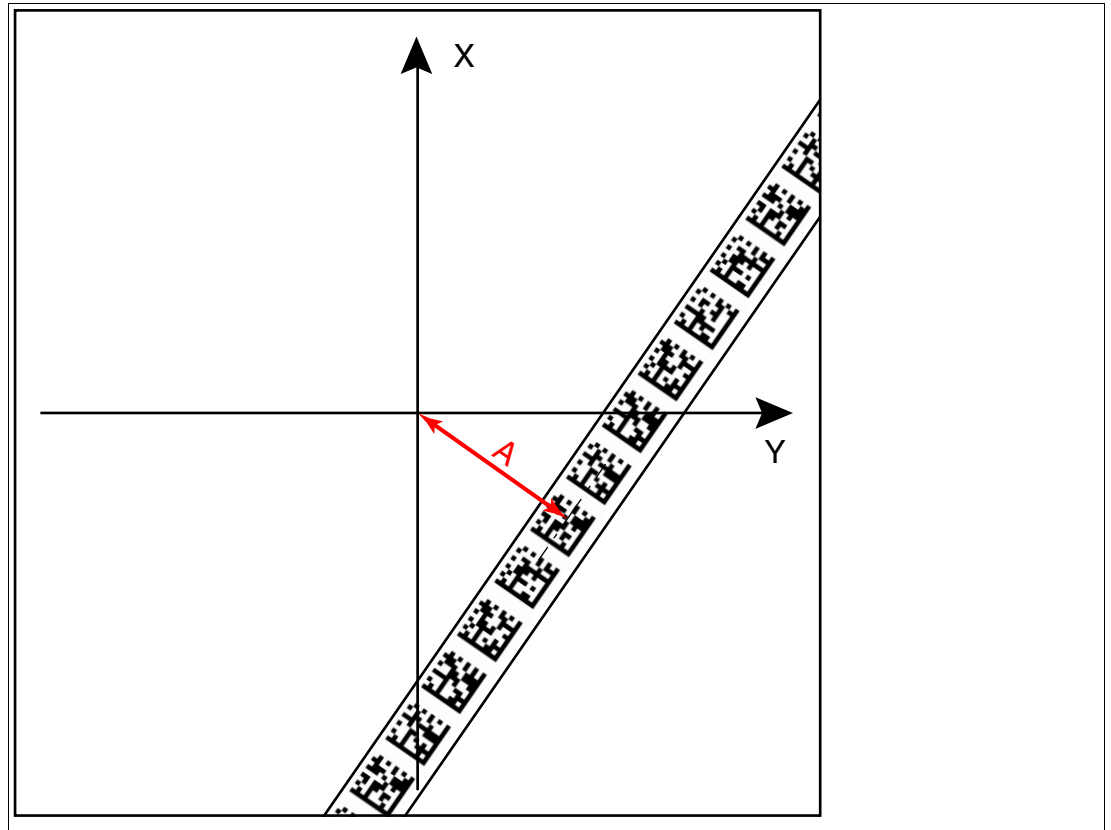

Figure 3.7 Distance A for Data Matrix code tape

Branches

The read head detects one lane at the lower edge of the field of vision and two lanes at the upper edge of the field of vision; the read head indicates this as a branch.

The read head detects two lanes at the lower edge of the field of vision and one lane at the upper edge of the field of vision; the read head indicates this as an intersection.

Branches or intersections can be displayed as follows:

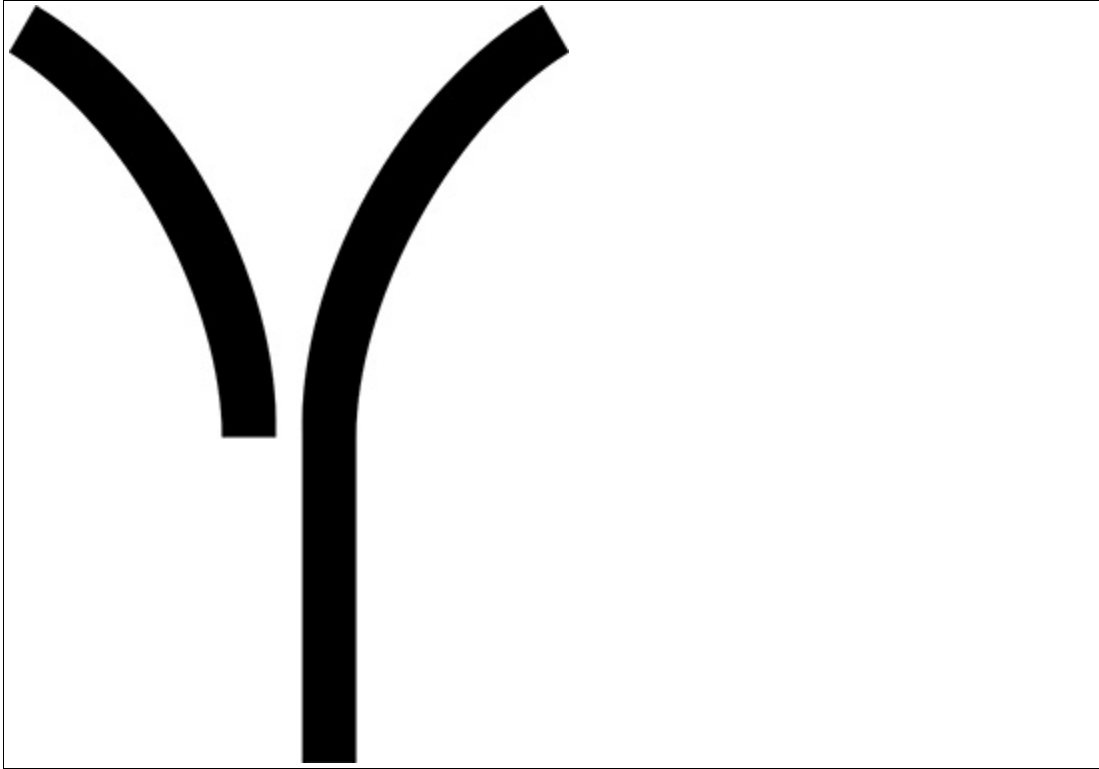

Figure 3.8 Separate lane branches off/converges

The read head can make the following direction decisions based on the lane and possible branches:

- Follow left-hand lane
- Straight ahead
- Follow right-hand lane

The direction decision is signaled to the read head via the controller. If there is no direction decision, the read head displays an error message.

Code Tapes for Control and Positioning

In addition to tracking the lane, the read head can also detect Data Matrix codes. This process involves evaluating both control and position information. Data Matrix control codes are used as event markers. Control codes provide information on branches. Data Matrix code tapes for positioning indicate the absolute position of the read head.

Note the following conditions:

Data Matrix code tapes for positioning are used instead of the colored tape.

Data Matrix control codes are used in tandem with the colored tape or Data Matrix position code.

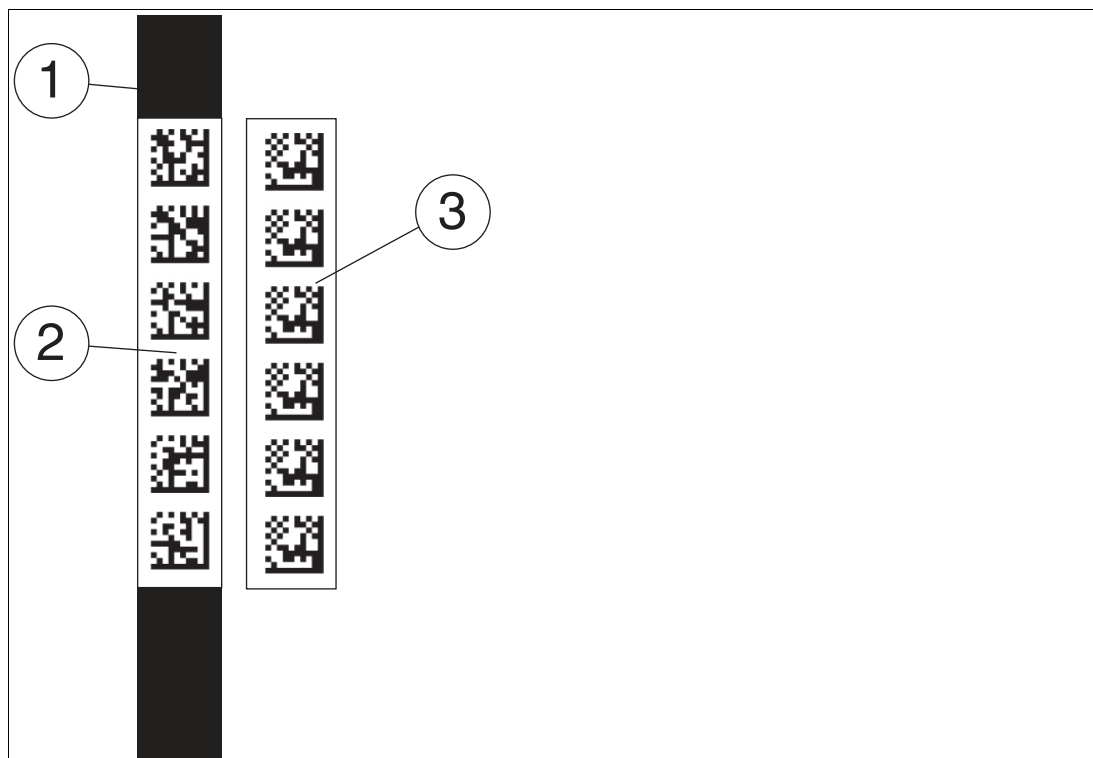

- 1 Colored tape
- 2 Data Matrix position code
- 3 Data Matrix control code

Branches or intersections with position information can be displayed as follows:

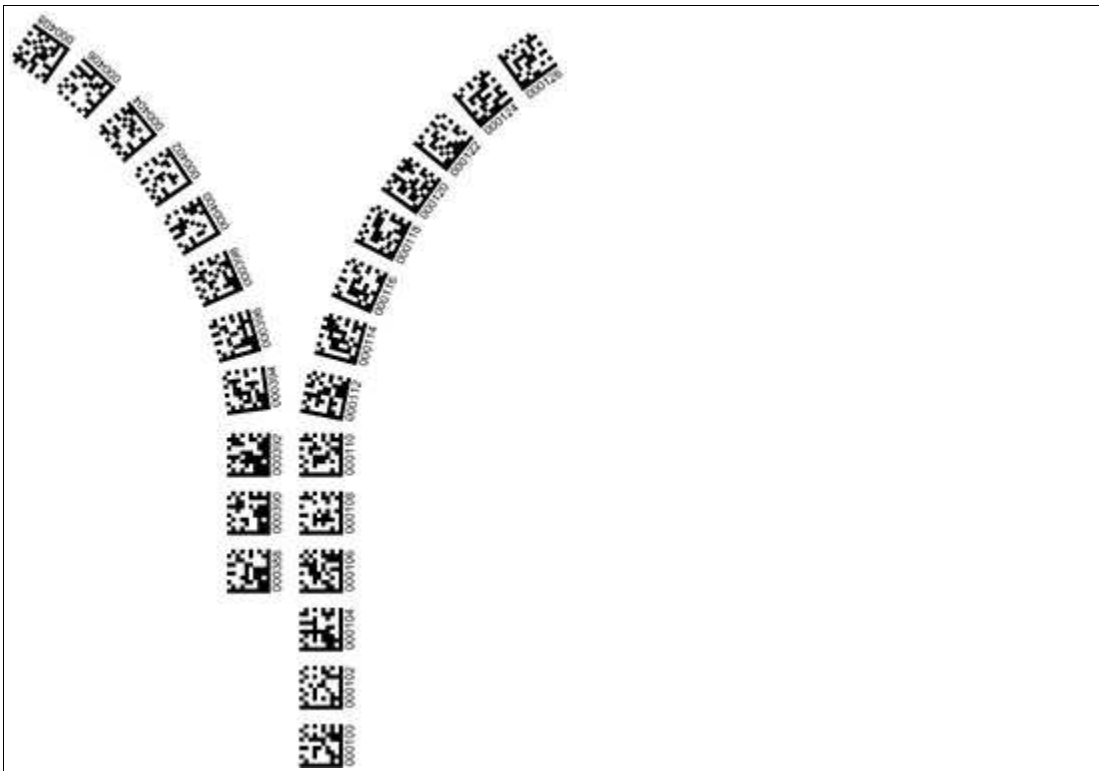

Figure 3.9 Separate lane branches off/converges

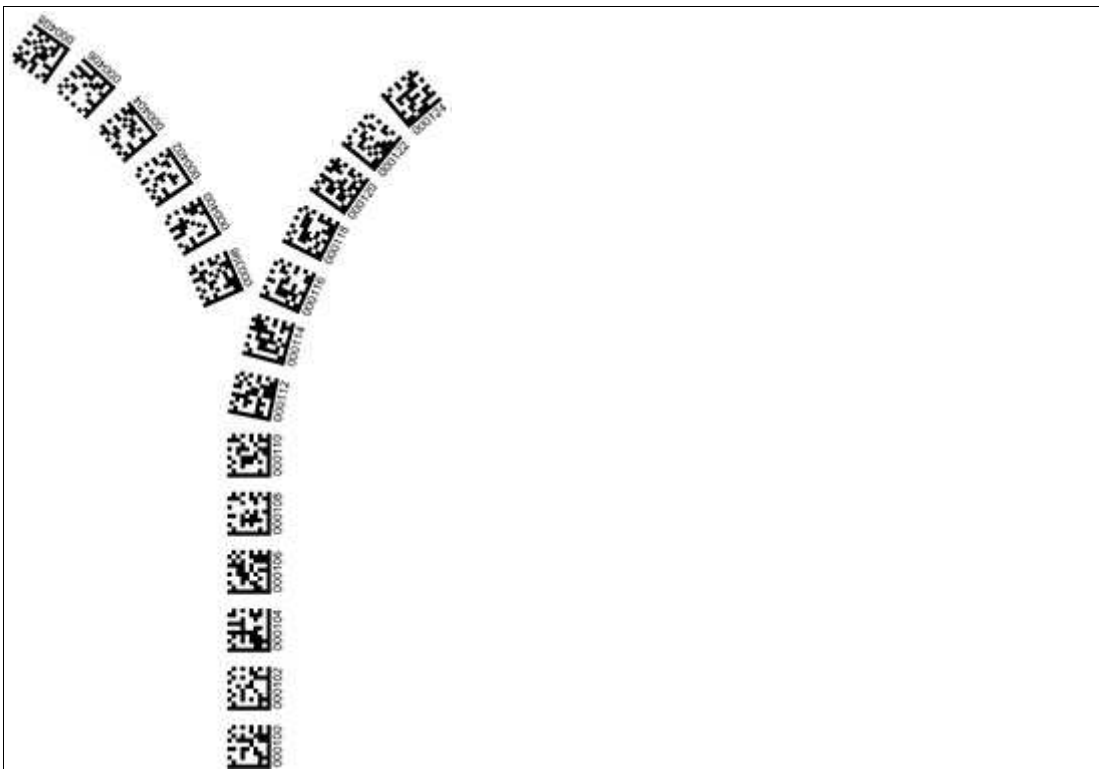

Figure 3.10 Same lane branches off/converges

**Note****Direction Decision**

The direction decision at a branch of a Data Matrix code tape remains in effect until the read head has moved more than 50 cm from the branch.

It is not possible to change the direction decision within a branch!

**Note****Priority**

Data Matrix code tapes and Data Matrix tags have priority over colored tapes or colored lanes. If the read head detects a Data Matrix code tape or Data Matrix tags in the field of view, colored tapes or colored lanes in the field of view are ignored.

**Note****Branches/Intersections with Data Matrix Position Code**

Observe the following guidelines less than 1 m before and after branching or intersection of a lane with a position code:

- The position codes of the main lane must run continuously for 2 m. The position codes of the branching/intersecting lane must run continuously for 1 m. The read head outputs the X-value of the Data Matrix code tape that is specified the direction decision. .
- Do not use repair tape.
- Do not use colored tape.
- The difference between the absolute position of the main lane and the starting position of the branching/intersecting lane must be greater than 1 m.

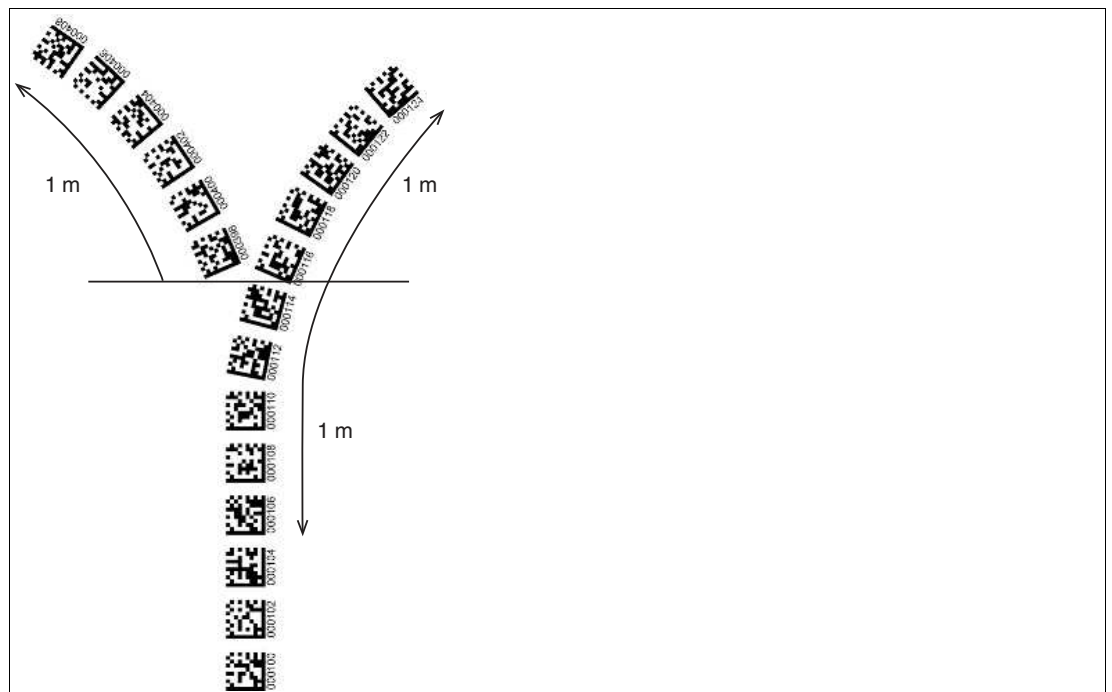

Figure 3.11 Distances

Behavior of the Read Head at Branches and Corners

The read head behaves differently depending on the type of branch and the specified lane. The read head must know the upcoming direction decision.

A second lane branches off to the left from the straight lane:

The read head follows the straight lane if the direction decision "follow right-hand lane" has been made.

A second lane branches off to the right from the straight lane:

The read head follows the straight lane if the direction decision "follow left-hand lane" has been made.

A single lane with a position code turns to the left or right:

The read head follows the position code if the direction decision "straight ahead" has been made.

Note

Loss of Information

Ensure that Data Matrix codes are not positioned over one another at a branch, as otherwise data may be lost.

It is not permitted to create a mixture of lanes made from colored tape and Data Matrix codes at branches or intersections.

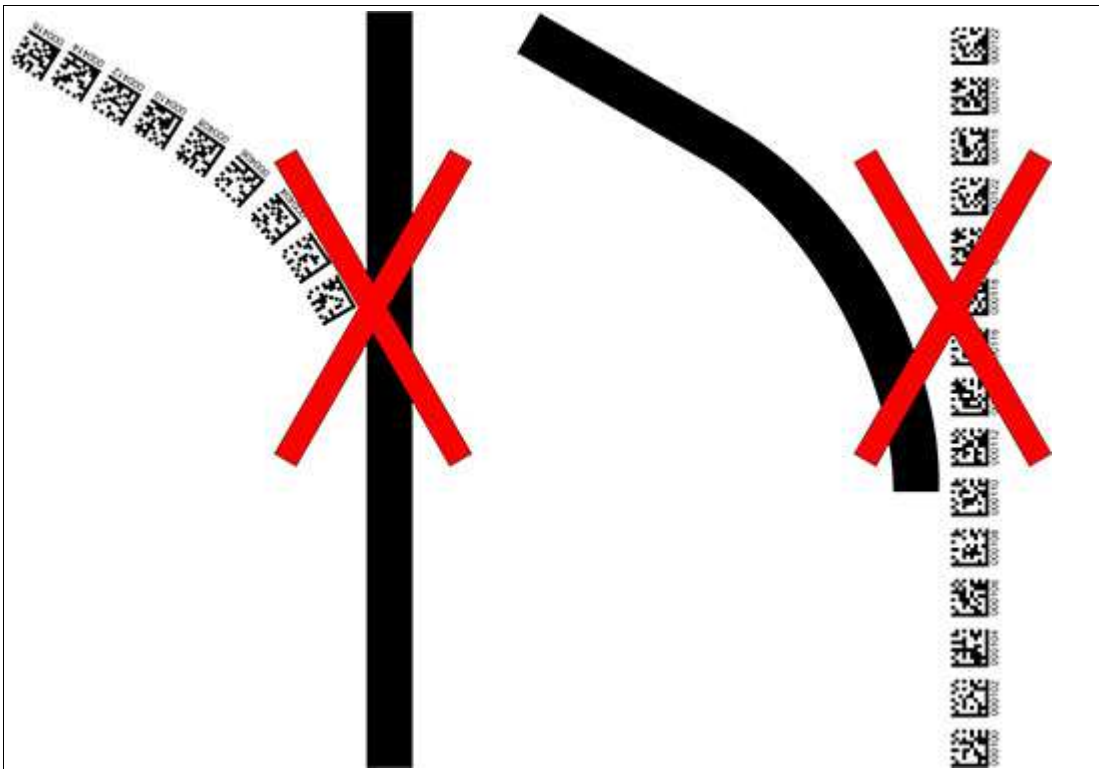

Figure 3.12 Mixture of lanes with colored tape and Data Matrix codes

Control codes can be mounted in the immediate vicinity of a branch with Data Matrix codes for positioning, but not near an intersection. The control code must be mounted directly next to the guiding lane.

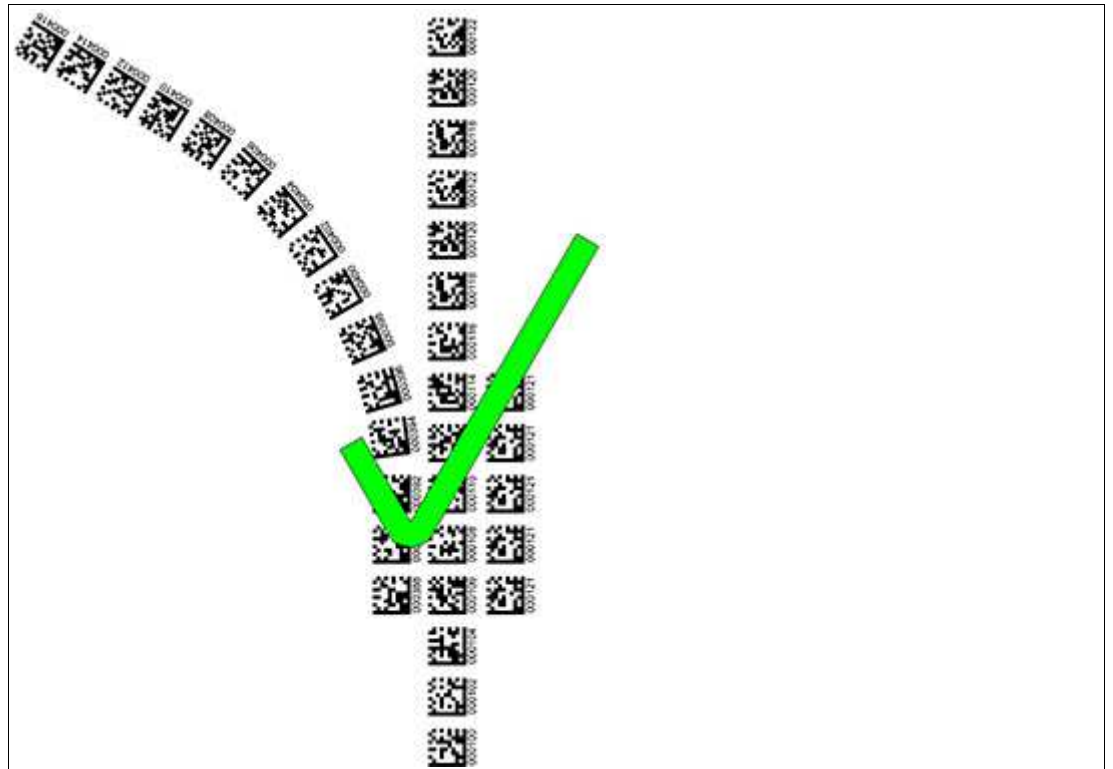

Figure 3.13 Branch with control code

Distances

To ensure that the read head can clearly detect and assign colored tapes and Data Matrix codes, minimum and maximum distances must be observed when creating the lanes.

Offset V between position codes of a lane must not be greater than 5 mm.



Figure 3.14 Offset: $0 \text{ mm} \leq V \leq 5 \text{ mm}$

The distance D between the colored tapes at a branch or intersection as a separate lane must not exceed 15 mm. The distance decreases if the guiding colored tape cannot be detected by the read head in the center of the reading window.

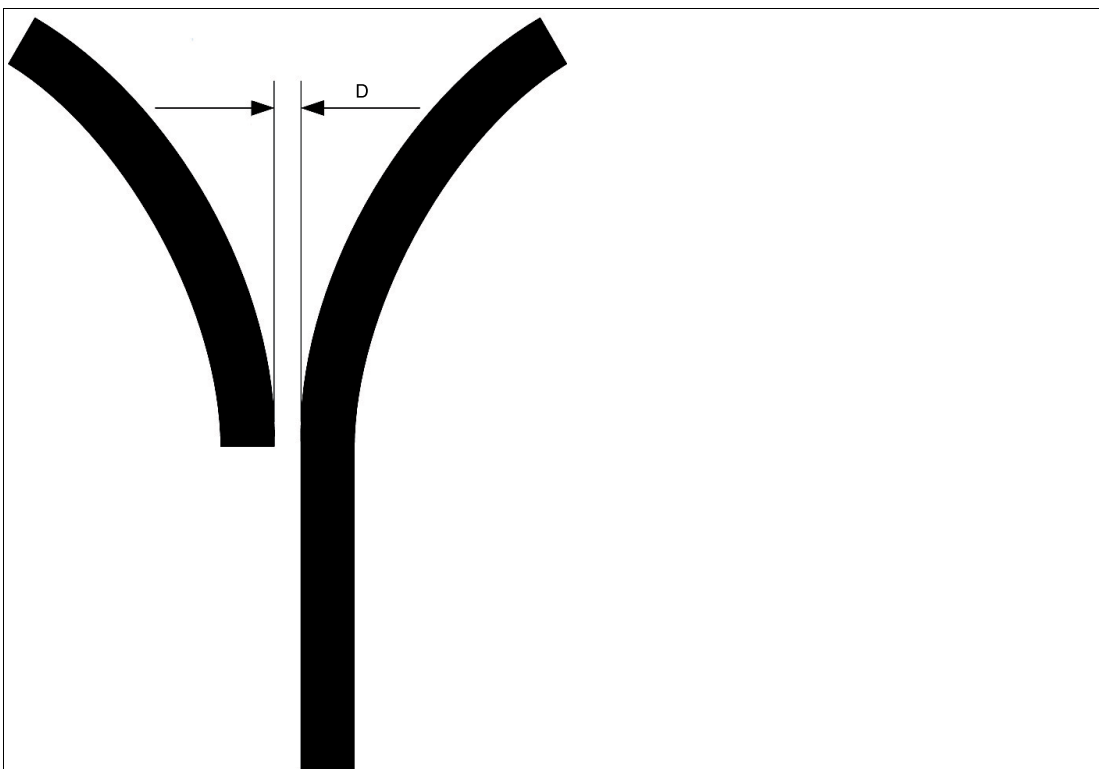

Figure 3.15 Distance: $7.5 \text{ mm} \leq D \leq 15 \text{ mm}$

The distance between the Data Matrix code tapes at a branch or intersection as a separate lane must be between 0 mm and 5 mm.

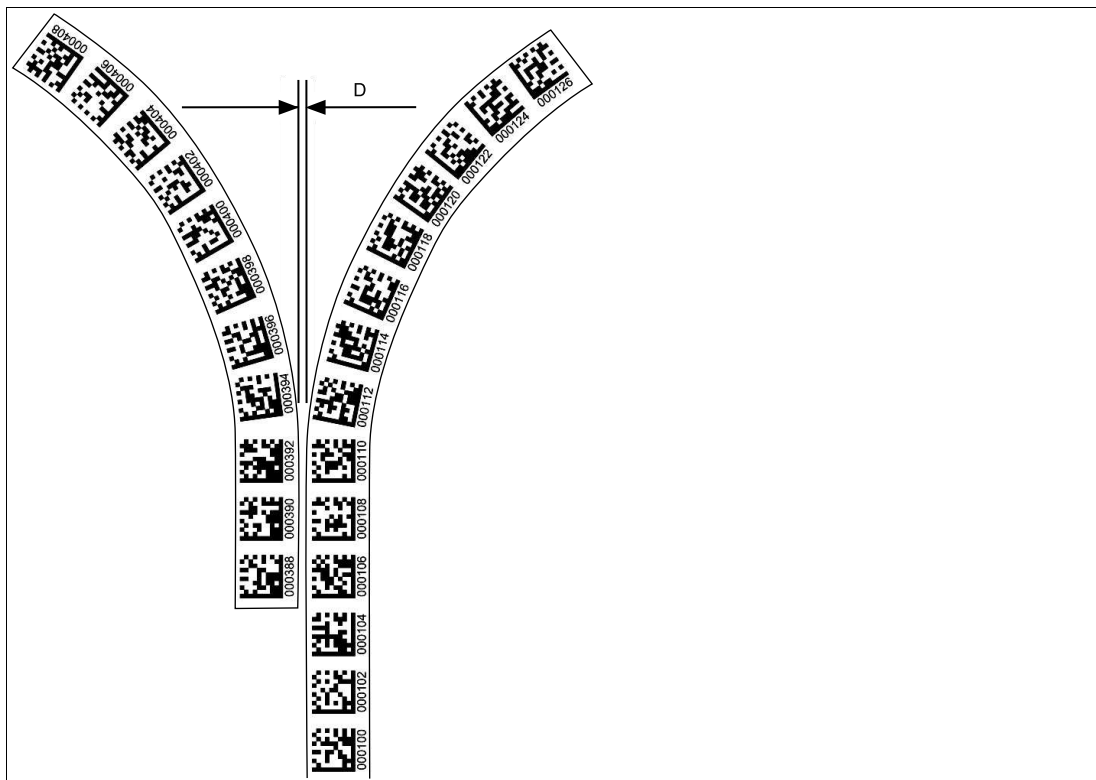

Figure 3.16 Distance: $0 \text{ mm} \leq D \leq 5 \text{ mm}$

The distance between a colored tape and a Data Matrix control code must be between 0 mm and 5 mm.

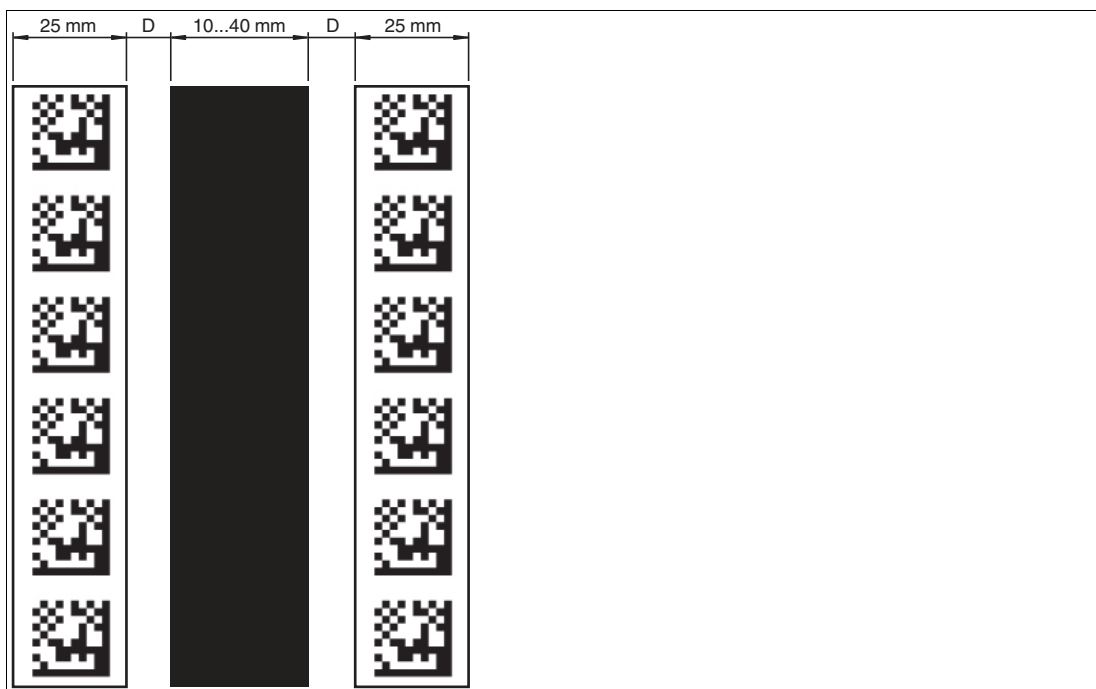

Figure 3.17 $0 \text{ mm} \leq D \leq 5 \text{ mm}$

The distance between a Data Matrix position code and a Data Matrix control code must be between 0 mm and 5 mm.

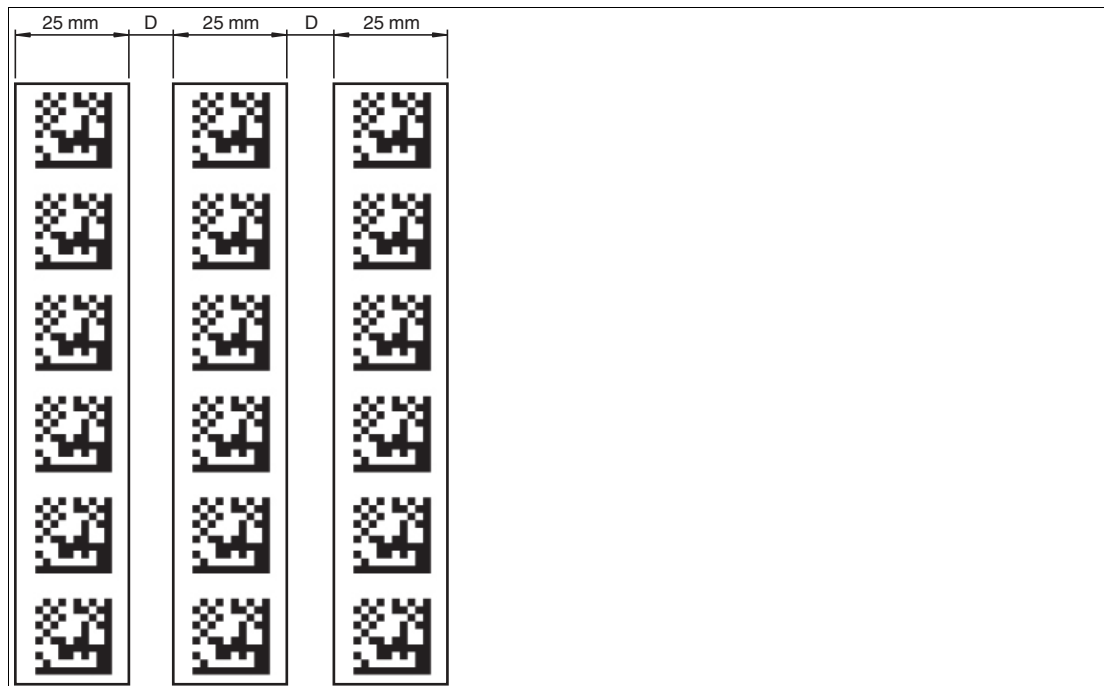

Figure 3.18 $0 \text{ mm} \leq D \leq 5 \text{ mm}$

A lane can switch from a colored tape to a Data Matrix code tape and back again as often as required. The distance between the colored tape and the edge of the Data Matrix code must be between 0 mm and 10 mm.

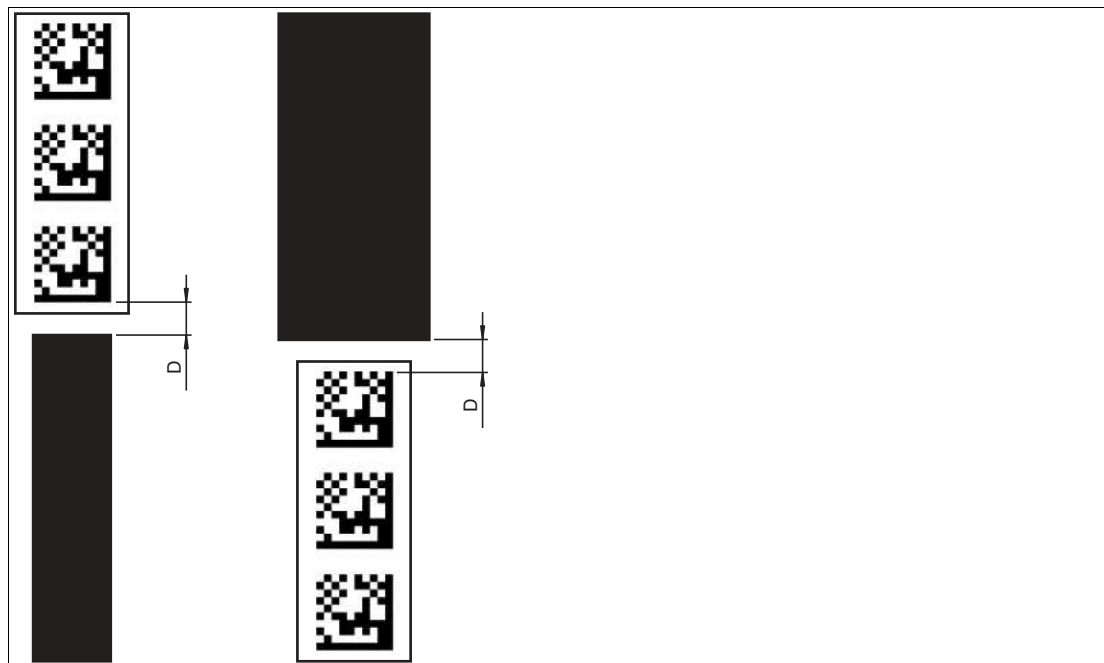

Figure 3.19 $0 \text{ mm} \leq D \leq 10 \text{ mm}$

The Y value does not change if the colored tape and the Data Matrix code tape are aligned. Ensure that the center line of the colored tape and the center line of the Data Matrix code are on a line.



Caution!

Alignment

The Data Matrix code is not on the center line of the code tape.

The code tape is made of silicone-free polyester film. A position marker appears every 100 mm along the lower edge of the code tape (see "Code Tape Dimensions"). This position marker is used for various functions, including precise positioning of the code tape during installation. The reverse side of the code tape carries a permanent modified acrylate-based adhesive. Affix the self-adhesive code tape along the desired travel path. To do so, proceed as follows:



Installing the Code Tape

1. Clean the surface of any greasy or oily deposits and dust.
2. Ensure that the surface is dry, clean, and stable.
3. Pull away a few centimeters of the protective film at the beginning of the code tape. Place the code tape at the precise point of the required starting position on the surface, and press to attach.
4. Then affix the code tape along the desired travel path. Remove the protective film gradually so that the code tape does not accidentally adhere to the surface in the incorrect position. When affixing, ensure that the code tape does not crease or trap air bubbles.

↳ The adhesive on the code tape hardens after 72 hours.



Note

Thermal Expansion of the Code Tape

The affixed code tape corresponds to the heat expansion coefficient of the surface with regard to its thermal expansion.

Code Tape Dimensions

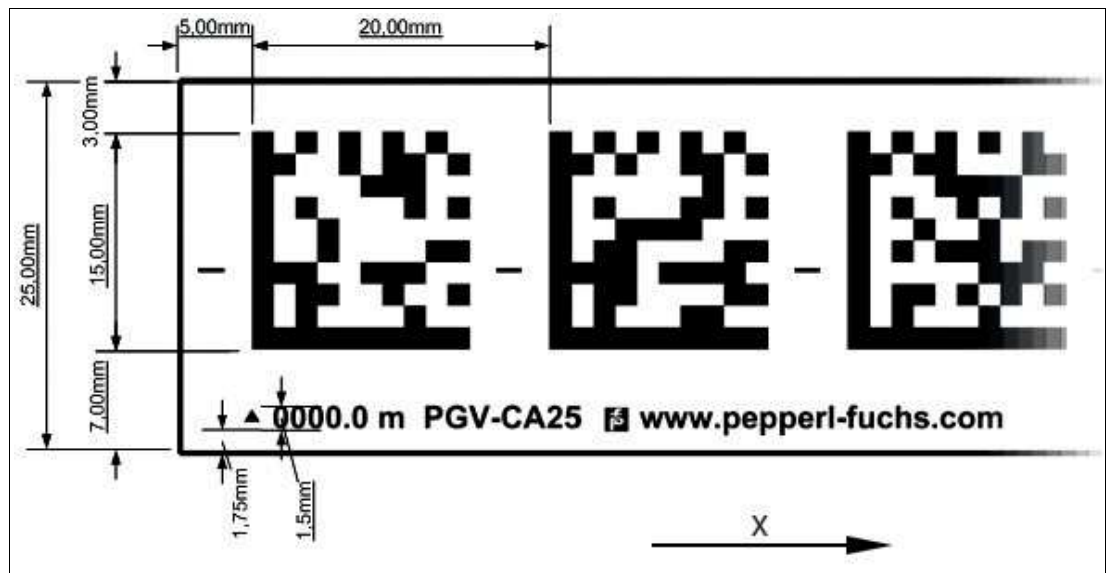

Figure 3.20 The center line indicates the center of the code tape and not the center of the code
 Position the code tape so that the **www.pepperl-fuchs.com** label and the position markings are to the right of the Data Matrix code in the X direction. The position values then increase along the X direction.

Data Matrix Code Tapes with a Starting Position of 0 m

Order designation	Description
PGV10M-CA25-0	Code tape, length: 10 m
...	...
PGV100M-CA25-0	Code tape, length: 100 m

Table 3.3 See also data sheet PGV*-CA25-* at www.pepperl-fuchs.com

Data Matrix control codes

Order designation	Description
PGV-CC25-001	Code tape, Control Code 001, length: 1 m
...	...
PGV-CC25-999	Code tape, Control Code 999, length: 1 m



Caution!

Stop edges

If you attach another code tape at the end of a previous code tape, the code pattern of 20 mm must be retained.



Note

Bends

If mounting the code tape in corners, cut the code tape several times as illustrated.

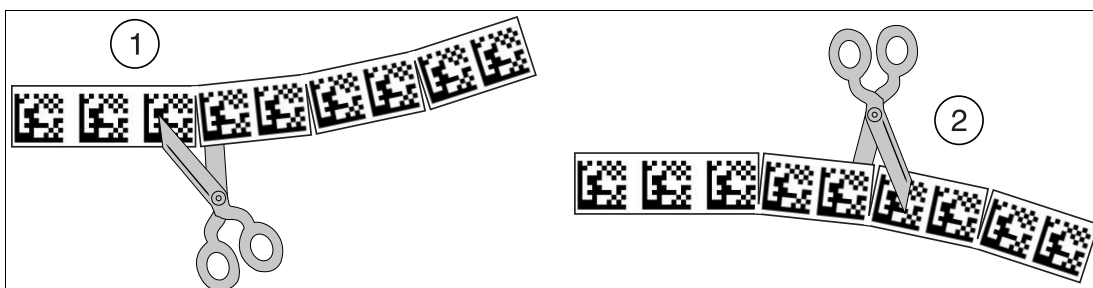

- 1 Bend to the left
- 2 Bend to the right

Data Matrix Tag

A Data Matrix tag contains position information in addition to a specific number. A cross in the center of the Data Matrix tag marks the zero point. The X and the Y axes are marked starting from the zero point. The black arrow indicates the positive axis and the white arrow indicates the negative axis.

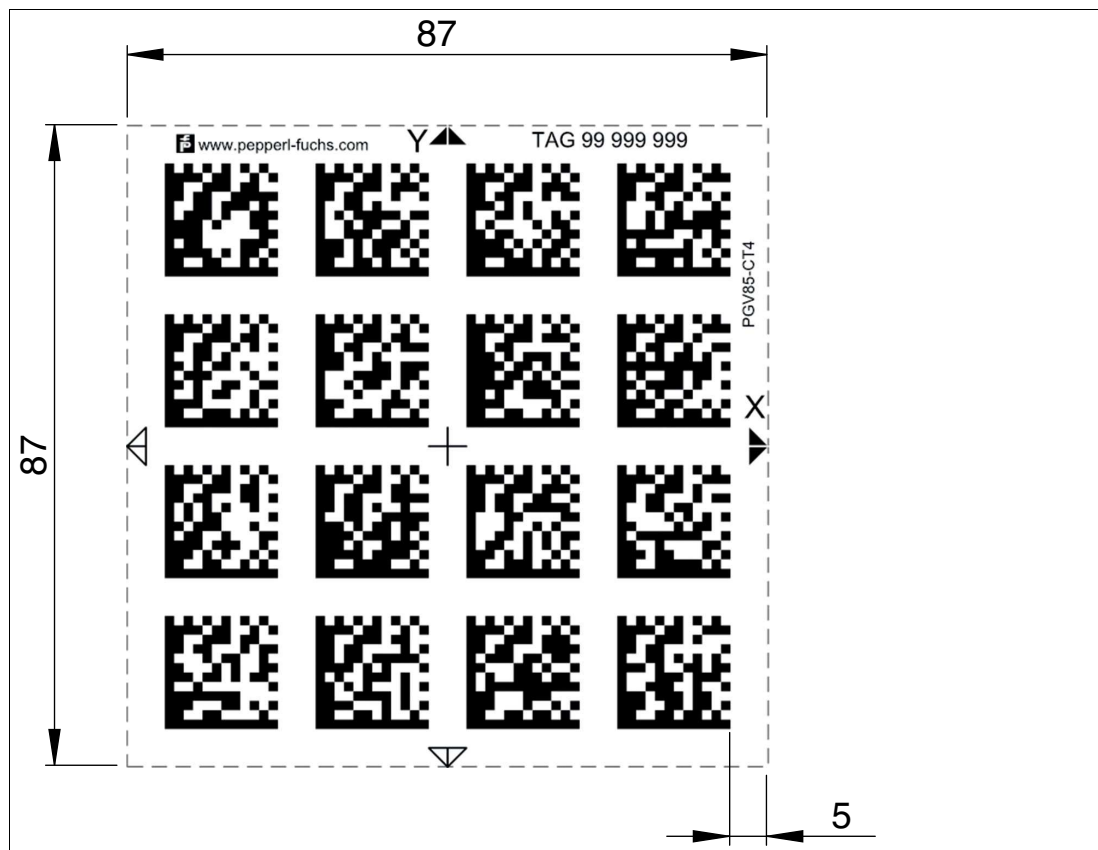

Figure 3.21 Data Matrix tag with the number 99999999 and position information

3.3 Electrical connection

The read head is connected electrically via an 8-pin M12 x 1 connector plug on the side of the housing. The voltage supply and communication with peripheral devices are established via this connection. The configurable inputs and outputs on the read head are also located at this connection.



Figure 3.22 Electrical connection of the read head

Plug Assignment

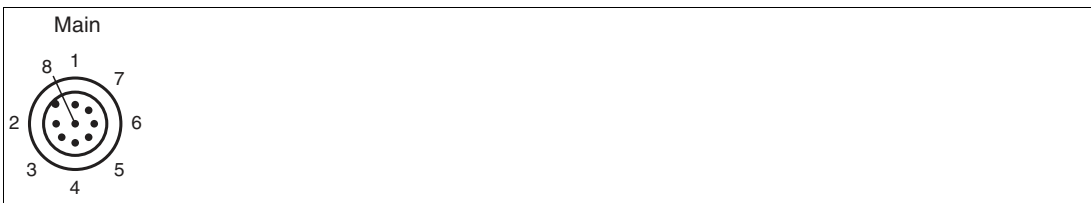

Figure 3.23 Plug assignment of the read head

Color assignment

Pepperl+Fuchs single-ended female cordsets are manufactured in accordance with EN60947-5-2. When using a type V19-... single-ended female cordset with an open cable end (see chapter 2.3) on the **Main** connection, the following color assignment applies:

Connection pin	Core color	Color abbreviation
1	White	WH
2	Brown	BN
3	Green	GN
4	Yellow	YE
5	Gray	GY
6	Pink	PK
7	Blue	BU
8	Red	RD

Table 3.4 Color assignment for connection to the single-ended female cordset

Shielding Cables

The shielding of connection lines is required to suppress electromagnetic interference. Establishing a low resistance or low impedance connection with the protective conductor or equipotential bonding circuit is a particularly important factor in ensuring that these interference currents do not become a source of interference themselves. Only use connection lines with braid. Avoid connection lines with foil shield because this would increase the line capacities. The shielding is integrated at both ends, i.e., in the switch cabinet or on the PLC, **and** on the read head. The grounding terminal available as an accessory allows easy integration in the equipotential bonding circuit.

In exceptional cases, the shielding of a connection at one end may be more favorable if:

- An equipotential bonding cable is not laid or cannot be laid.
- A film shield is used.

The following points relating to shielding must be noted:

- Use metal cable clips that cover large areas of the shielding.
- Place the cable shield onto the equipotential bonding rail immediately on entering the switch cabinet.
- Direct the protective grounding connections to a common point in a star configuration.
- The cross-section of the cables used for grounding should be as large as possible.

Additional Ground Connection



Tip

Using a short ground wire, establish grounding at the nearest ground connection.

Model number	Description
PCV-SC12	Clip for mounting an additional ground connection.
PCV-SC12A	



Caution!

Damage to the device

Connecting an alternating current or excessive supply voltage can damage the device or cause the device to malfunction.

Electrical connections with reversed polarity can damage the device or cause the device to malfunction.

Connect the device to direct current (DC). Ensure that the supply voltage rating is within the specified device range. Ensure that the connecting wires on the female cordset are connected correctly.

3.4 EtherNet/IP Connection

The read head is connected to EtherNet/IP via two 4-pin, D-coded connector sockets, M12 x 1, **port 1** and **port 2**, on the side of the housing.

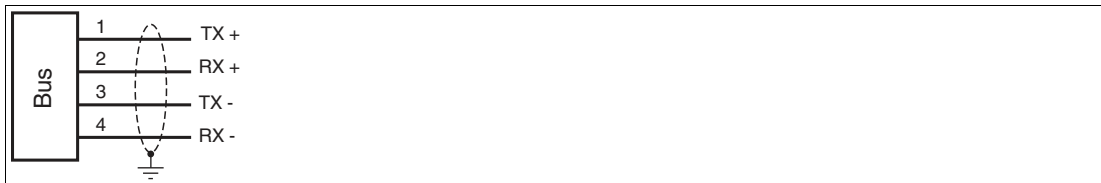

Figure 3.24 EtherNet/IP electrical connection

Plug Assignment



Figure 3.25 Plug assignment for EtherNet/IP

Suitable Ethernet cables can be found in the Accessories section of the read head datasheet at www.pepperl-fuchs.com.

4 Commissioning

4.1 Direction Decision

The read head has several ways of following colored tapes and Data Matrix code tapes depending on the parameterization. Depending on the input signal, the read head follows the right-hand lane, the left-hand lane, or the better lane.

To ensure that the read head does not report any error messages after being switched on, a direction decision must be specified. You can control the decision direction via inputs INPUT_SELECTION_DIR_RIGHT (IN2/DIR_RIGHT) and INPUT_SELECTION_DIR_LEFT (IN1/DIR_LEFT) or via the protocol.

Direction Decision via Input Signal

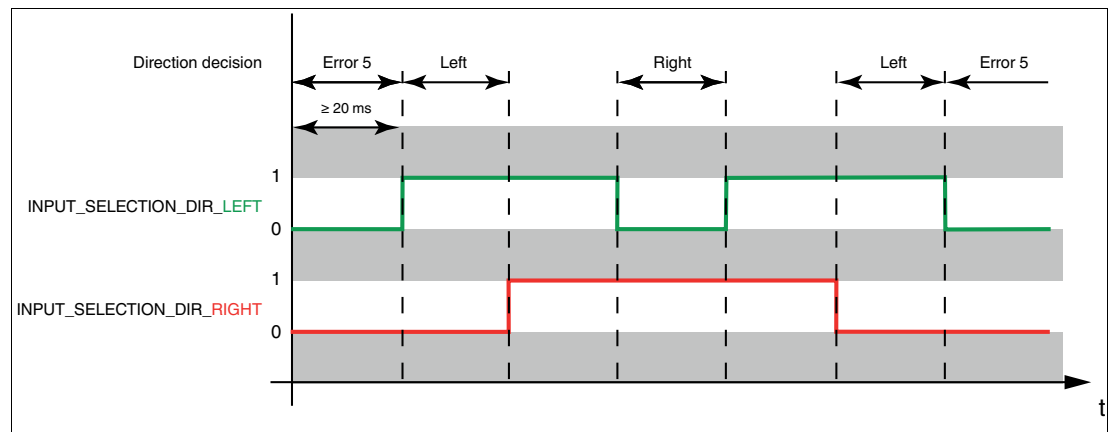

Figure 4.1

Input 2 INPUT_SELECTION_DIR_LEFT	Input 1 INPUT_SELECTION_DIR_RIGHT	Direction Decision
0	0	No lane is selected Error code 5
0	1	Follow right-hand lane
1	0	Follow left-hand lane
1	1	Colored tape: follow lane with better quality Data Matrix code tape: follow lane with more detailed position information Data Matrix tag: no significance

Table 4.1

Direction Decision via Protocol

Direction control via the protocol.

If direction decisions are made via the protocol, subindex 12 "Input source selection" must be switched to "Software" in the global primary data.



Note

If direction decisions are sent to the read head via a protocol, the input signals from the hardware input are ignored until the read head is reset.

Following the Lane with Better Quality

You can parameterize the read head so that it follows the color lane with better quality.

Example

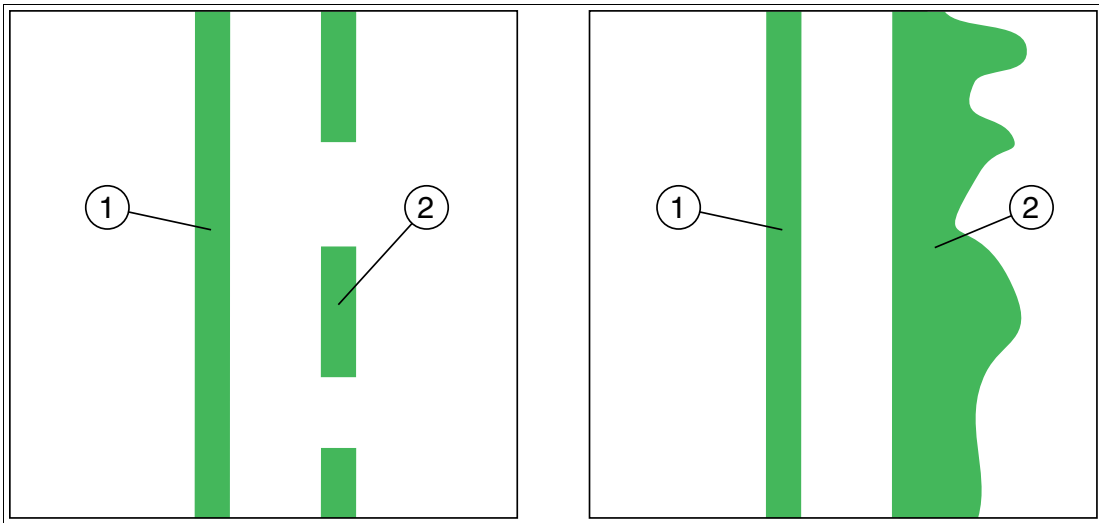

Figure 4.2 1 - Better color lane
2 - Worse color lane

Following the Lane with More Detailed Position Information

You can parameterize the read head so that it follows the Data Matrix code tape that has more detailed current position information.

Example

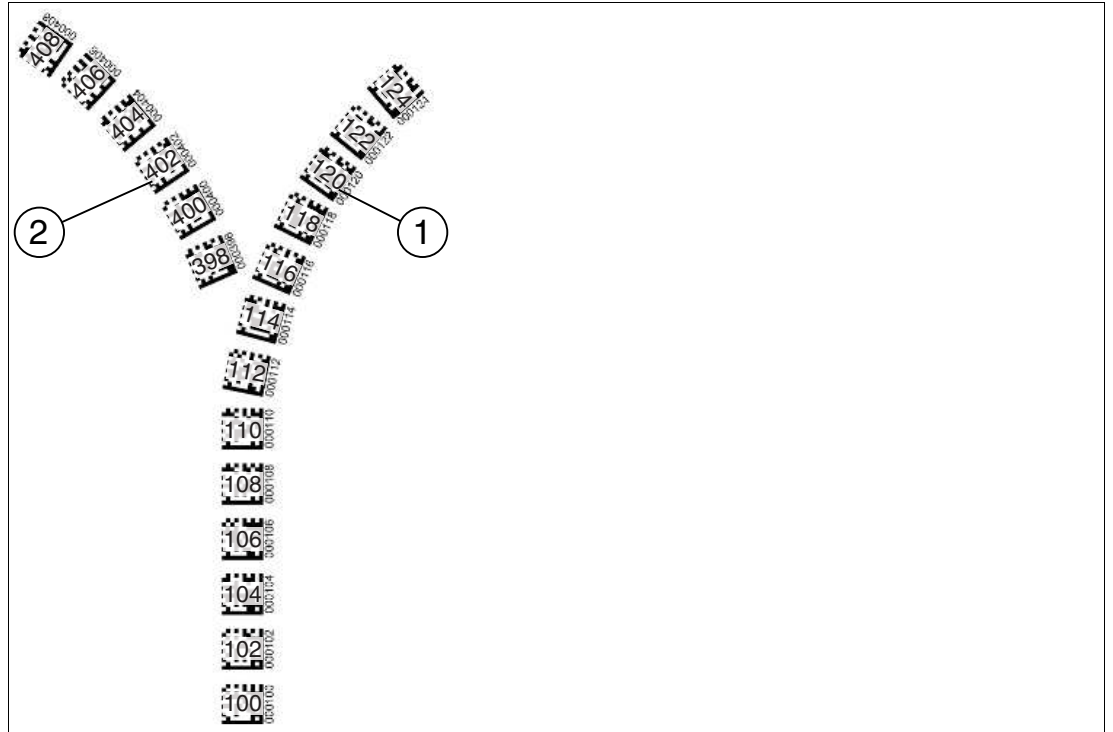

Figure 4.3 1 - More detailed position information
2 - New position information

5 Communication via EtherNet/IP

5.1 General Information on Communication via EtherNet/IP

The read head communicates with the controller (e.g., PLC) via EtherNet/IP. An object-oriented fieldbus system for exchanging data between nodes based on Ethernet technology.

The management and development of the EtherNet/IP standards are subject to the Open DeviceNet Vendor Association (ODVA). More information on EtherNet/IP will be supplied on request by the Open DeviceNet Vendor Association (ODVA) at the following Internet address:

ODVA, Inc

4220 Varsity Drive, Suite A

Ann Arbor, MI 48108-5006 USA

<http://www.odva.org> e-mail: <mailto:odva@odva.org>

The basic properties of the interface are:

- Transfer rate 10 Mbit/s or 100 Mbit/s, half or full duplex operation
- Automatic negotiation of the transfer rate and the duplex method (auto-negotiation)
- Automatic setting for crossed lines (auto-crossover)

EtherNet/IP protocol works according to the CIP protocol (Common Industrial Protocol) and is used to control, configure, monitor, and collect data. Time-sensitive data exchange (implicit messaging) takes place using the UDP/IP protocol and non-time-sensitive data exchange (explicit messaging) using the TCP/IP protocol.

The read head supports the following features:

- "Listen only", "Input only", and "Exclusive Owner" connection types
- Message transmission as "Multipoint data transfer" (Multicast) and "Point-to-point data transfer" (Unicast)
- Cycle time (request packet interval) ≥ 2 ms
- Dynamic Host Configuration Protocol (DHCP)
- Device Level Ring (DLR)
- Address Conflict Detection (ACD)

The read head is integrated in the network via a EDS file (electronic data sheet) with a configuration tool such as RSLOGIX5000. The EDS file contains all of the information about device-specific parameters and operating modes.

Downloading the EDS file

You can find the relevant EDS file in the **Software** section of the product detail page for the device.

To access the product detail page for the device, go to <http://www.pepperl-fuchs.com> and type information about the device (e.g., the product description or the item number) into the search function.

5.2 Setting the IP Address

The read head is delivered in DHCP mode and waits for an address assignment from the control system.

The following section describes the address assignment via the software **BOOT/DHCP server** from Rockwell Automation as an example.



1. Connect the read head with the DHCP server.
2. Start the **BOOT/DHCP server** software.
3. Enter the following data in the **Network Settings** menu:
 - Subnet Mask "255.255.255.0 "
 - Gateway "192.168.1.1"
 - the remaining fields are not filled in.

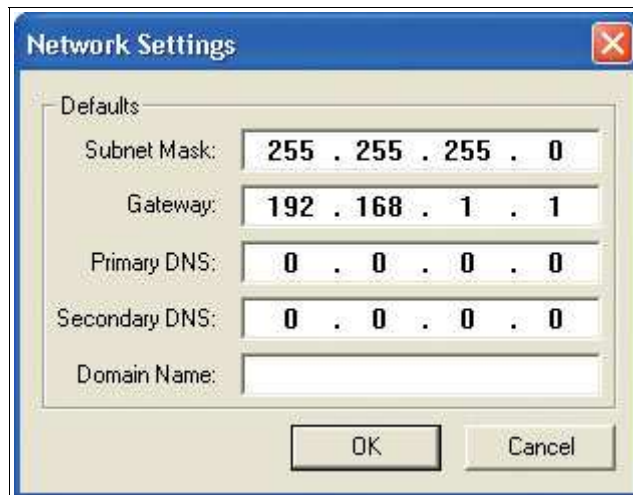

4. Switch on the supply voltage to the read head.

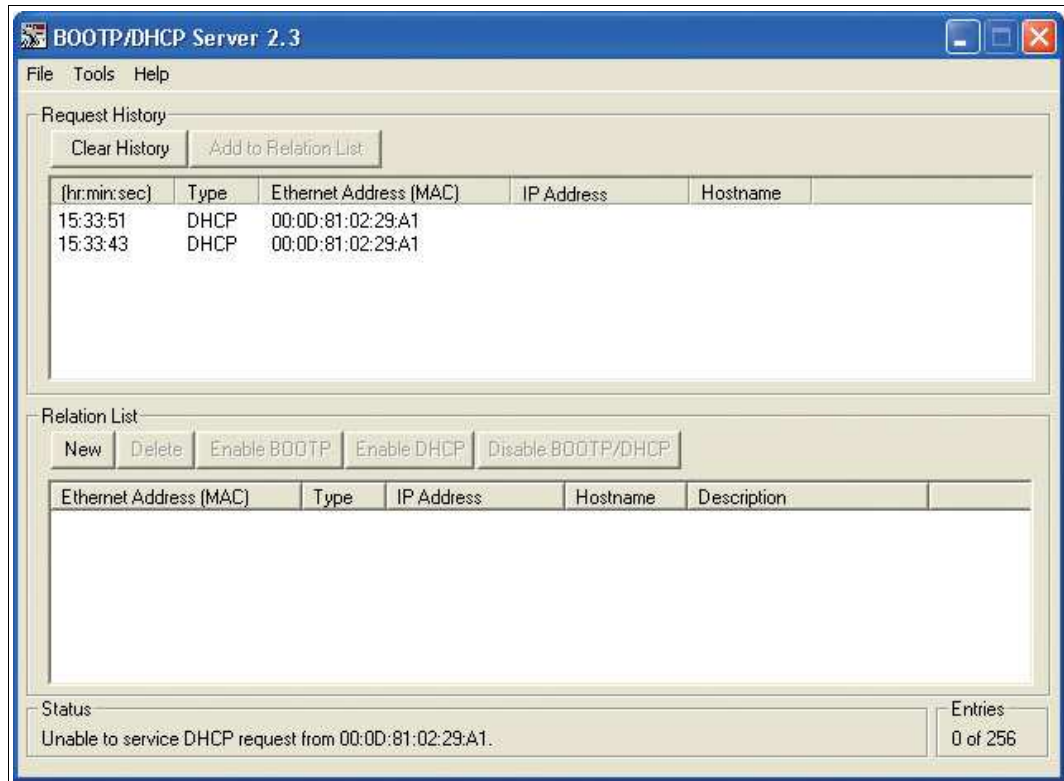

↳ The read head cyclically carries out DHCP requests. This enters the MAC address of the read head in the **Request History** field to the list.

5. Enter the desired IP address in the **New Entry** menu.
 - The software automatically adopts the MAC address of the read head.
 - The "hostname" function is not supported.
 - You may enter text under "Description".

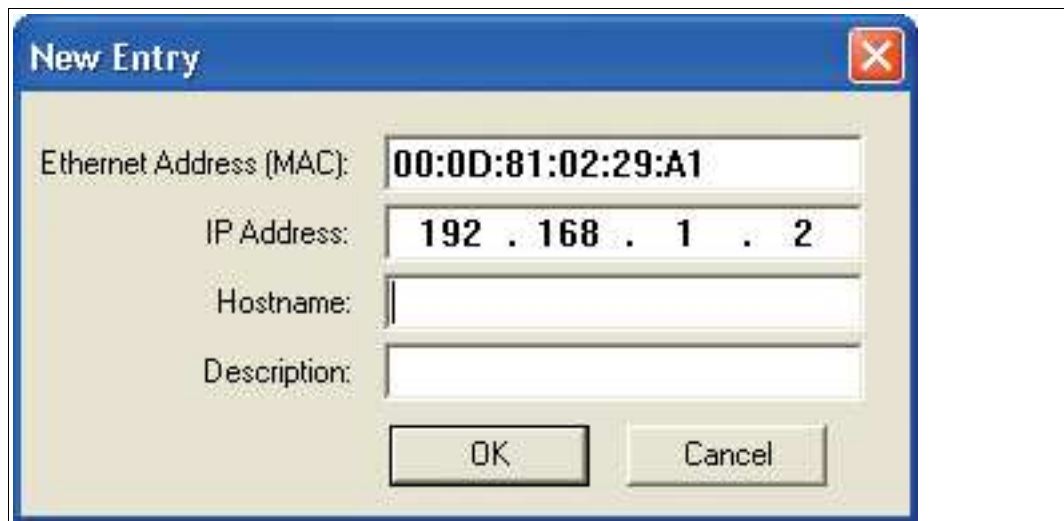

6. Confirm the entries of the address data using **OK**.

↳ The IP address is assigned to the read head on the next DHCP request. The new address data will be displayed in the **Relation List** field.

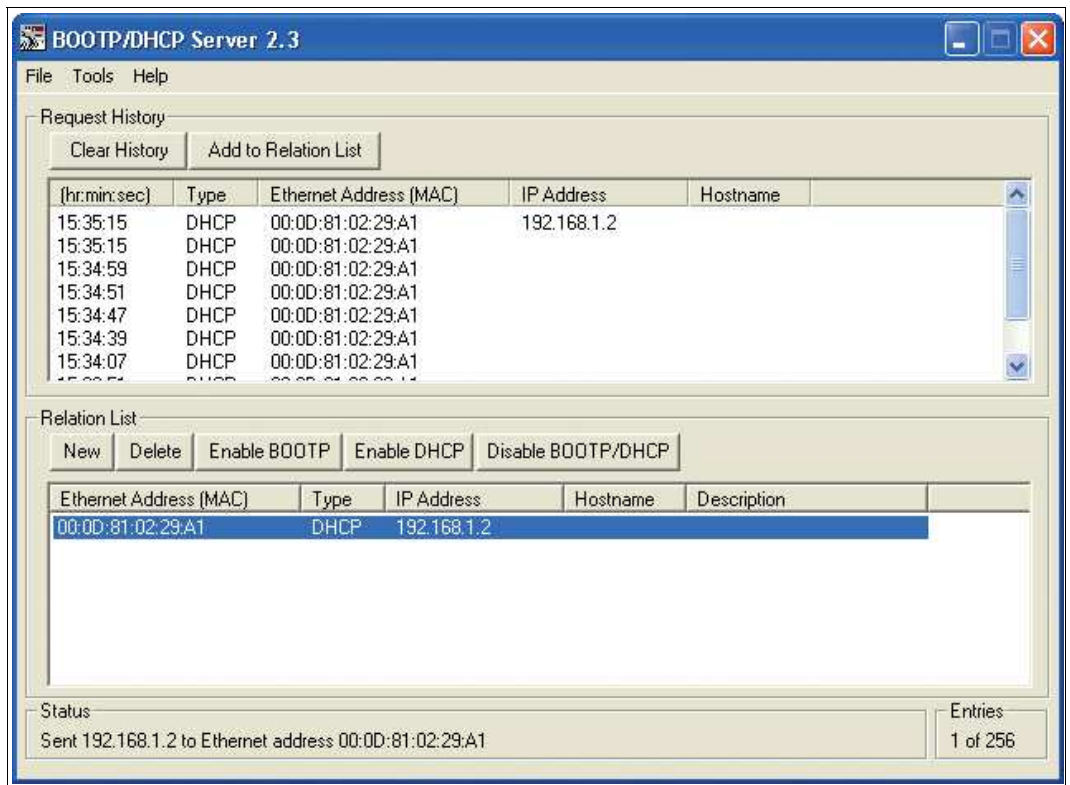

- Press the **Disable BOOTP/DHCP** key in the **Relation List** field.
 ↳ In this way, the assigned IP address is saved permanently in the read head.

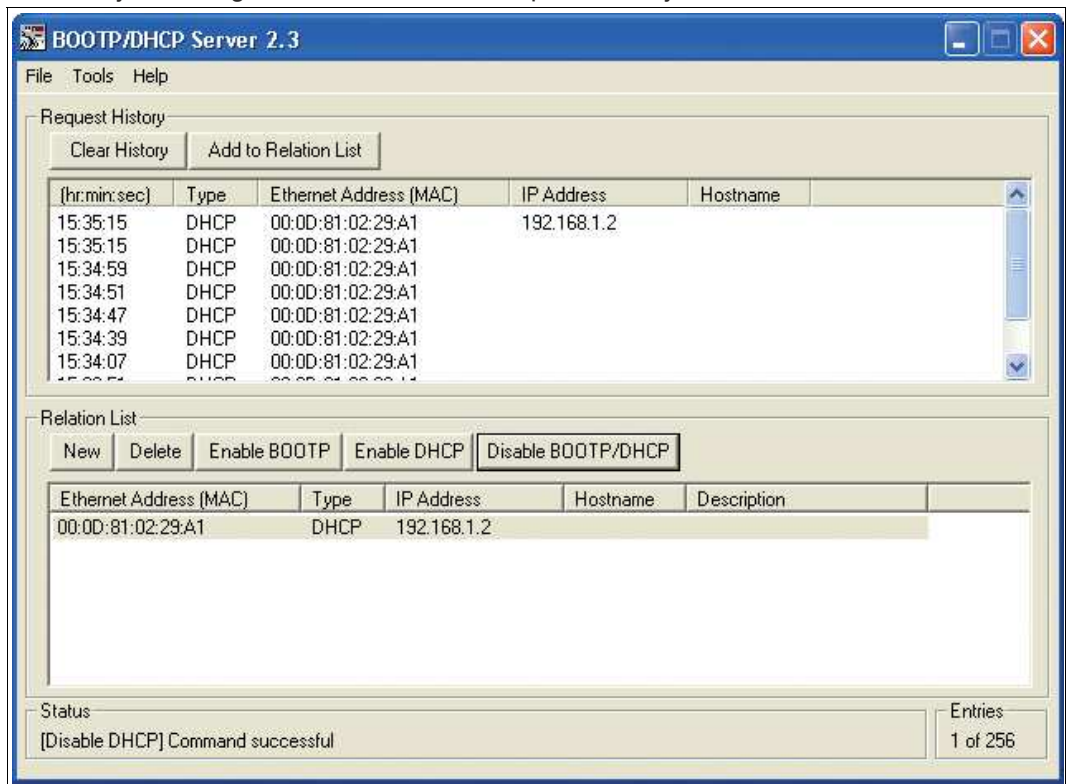

5.3 EtherNet/IP Objects

All the data and functions of the read head are defined via objects in accordance with the EtherNet/IP standards.

The read head supports the following listed standard-specific classes.

Standard Classes

Class ID	Class description
0x01	Identity object
0x02	Message router object
0x04	Assembly object
0x06	Connection manager object
0xF5	TCP/IP interface object
0xF6	Ethernet link object
0x47	DLR object
0x48	Quality of service

The parameters are not directly addressable from the network with the "Set" or "Get" attribute services. Access is via assembly objects (class code 0x04)

Cyclic Data Communication with Assembly Objects (Class Code 0x04)

Assemblies are special CIP objects used for cyclic data communication (implicit messaging). Assemblies are composed of one or more attributes of various objects. These objects allow you to send or receive data from multiple objects via a connection. The composition of the assemblies is fixed in the read head and cannot be modified by the user.

Input Assemblies

Instance no.	Description	Size [byte]	Attribute	Attribute ID	Data type
100	Status, Y position, angle	8	Status	100	UINT
			Y position	101	DINT
			Angle	104	UINT
101	Status, Y position, angle, warning, error	12	Status	100	UINT
			Y position	101	DINT
			Angle	104	UINT
			Warning	102	UINT
102	Status, Y position, angle, X position, Z distance	14	Status	100	UINT
			Y position	101	DINT
			Angle	104	UINT
			X position	105	UDINT
			Z distance	106	UINT
103	Status, Y position, angle, X position, Z distance, CCL status, CCL value, warning, error	21	Status	100	UINT
			Y position	101	DINT
			Angle	104	UINT
			X position	105	UDINT
			Z distance	106	UINT
			CCL status	107	USINT
			CCL value	108	UINT
			Warning	102	UINT
Error	103	UINT			
104	Status, Y position, angle, X position, TAG number	16	Status	100	UINT
			Y position	101	DINT
			Angle	104	UINT
			X position	105	UDINT
			Tag value	109	UDINT
105	Status, Y position, angle, X position, TAG number, CCL status, CCL value, warning, error	23	Status	100	UINT
			Y position	101	DINT
			Angle	104	UINT
			X position	105	UDINT
			Tag value	109	UDINT
			CCL status	107	USINT
			CCL value	108	UINT
			Warning	102	UINT
Error	103	UINT			

Instance no.	Description	Size [byte]	Attribute	Attribute ID	Data type
106	CCL status, CCL value	3	CCL status	107	USINT
			CCL value	108	UINT
107	Warning, error	4	Warning	102	UINT
			Error	103	UINT
108	Status, Y position, angle, X position, Z distance, TAG number, CCL status, CCL value, warning, error	25	Status	100	UINT
			Y position	101	DINT
			Angle	104	UINT
			X position	105	UDINT
			Z distance	106	UINT
			Tag value	109	UDINT
			CCL status	107	USINT
			CCL value	108	UINT
			Warning	102	UINT
			Error	103	UINT

Configuration assembly

Instance no.	Description	Size [byte]	Attribute	Attribute ID	Data type
110	Configuration	58	X resolution	110	UDINT
			Y resolution	111	UDINT
			Angle resolution	112	DINT
			Horizontal offset	113	DINT
			Vertical offset	114	INT
			Angle offset	115	DINT
			No position X	116	UDINT
			No position X value	117	UDINT
			No position Y	118	UDINT
			No position Y value	119	DINT
			No position angle	120	UDINT
			No position angle value	121	UDINT
			Color tape width	122	UDINT
			Color	123	UDINT
Input source selection	124	UDINT			

Output assembly

Instance no.	Description	Size [byte]	Attribute	Attribute ID	Data type
115	Output	1	Steering information	125	BYTE

5.4 EtherNet/IP Connections

No.	Type	Parameter	Output assembly	Input assembly	Configuration assembly
1	Exclusive owner	Status, Y position, angle	115	100	110
2	Input only	Status, Y position, angle	115	100	110
3	Listen only	Status, Y position, angle	115	100	110
4	Exclusive owner	Status, Y position, angle, warning, error	115	101	110
5	Input only	Status, Y position, angle, warning, error	115	101	110
6	Listen only	Status, Y position, angle, warning, error	115	101	110
7	Exclusive owner	Status, Y position, angle, X position, Z distance	115	102	110
8	Input only	Status, Y position, angle, X position, Z distance	115	102	110
9	Listen only	Status, Y position, angle, X position, Z distance	115	102	110
10	Exclusive owner	Status, Y position, angle, X position, CCL status, CCL value, warning, error	115	103	110
11	Input only	Status, Y position, angle, X position, CCL status, CCL value, warning, error	115	103	110
12	Listen only	Status, Y position, angle, X position, CCL status, CCL value, warning, error	115	103	110
13	Exclusive owner	Status, Y position, angle, X position, tag value	115	104	110
14	Input only	Status, Y position, angle, X position, tag value	115	104	110
15	Listen only	Status, Y position, angle, X position, CCL status, CCL value, warning, error	115	104	110
16	Exclusive owner	Status, Y position, angle, X position, CCL status, CCL value, warning, error	115	105	110
17	Input only	Status, Y position, angle, X position, CCL status, CCL value, warning, error	115	105	110
18	Listen only	Status, Y position, angle, X position, CCL status, CCL value, warning, error	115	105	110
19	Exclusive owner	Status, Y position, angle, X position, Z value, tag value, CCL status, CCL value, warning, error	115	108	110
20	Input only	Status, Y position, angle, X position, Z value, tag value, CCL status, CCL value, warning, error	115	108	110

No.	Type	Parameter	Output assembly	Input assembly	Configuration assembly
21	Listen only	Status, Y position, angle, X position, Z value, tag value, CCL status, CCL value, warning, error	115	108	110
22	Exclusive owner	Status, Y position, angle, X position, Z value, tag value, CCL status, CCL value, warning, error	115	108	-
23	Input only	Status, Y position, angle, X position, Z value, tag value, CCL status, CCL value, warning, error	115	108	-

Connection points

Name	Value
Listen only	192
Input only	193
Configuration	110
Output	115
Input_100	100
Input_101	101
Input_102	102
Input_103	103
Input_104	104
Input_105	105
Input_108	108

5.5 Overview of the Attributes of EtherNet/IP Objects

Read Head-Specific Attributes

ID	Type	Attribute	Data type	Size [byte]	Min.	Max.	Default
100	Input	Status word	UINT	2	-	-	-
101	Input	Y position	DINT	4	-	-	-
102	Input	Warning flags	UINT	2	-	-	-
103	Input	Error flags	UINT	2	-	-	-
104	Input	Angle	UINT	2	-	-	-
105	Input	X position	UDINT	4	-	-	-
106	Input	Z distance	UINT	2	-	-	-
107	Input	CCL status	USINT	1	-	-	-
108	Input	CCL value	UINT	2	-	-	-
109	Input	Tag value	UDINT	4	-	-	-
110	Configuration	X resolution	UDINT	4	0	2	1
111	Configuration	Y resolution	UDINT	4	0	2	1
112	Configuration	Angle resolution	DINT	4	360	3600	360
113	Configuration	Horizontal offset	DINT	4	-10000000	10000000	0
114	Configuration	Vertical offset	INT	2	-16383	16383	0
115	Configuration	Angle offset	DINT	4	-3600	3600	0
116	Configuration	No position X	UDINT	4	0	1	1
117	Configuration	No position X value	UDINT	4	0	100000000	0
118	Configuration	No position Y	UDINT	4	0	1	1
119	Configuration	No position Y value	DINT	4	-16383	16383	0
120	Configuration	No position angle	UDINT	4	0	1	1
121	Configuration	No position angle value	UDINT	4	0	65535	65535
122	Configuration	Color tape width	UDINT	4	10	40	18
123	Configuration	Color	UDINT	4	0	15	2
124	Configuration	Input source selection	UDINT	4	0	1	1
125	Output	Steering information	BYTE	1	0	31	0

Basic data structure

1 byte = 8 bit value

Byte 4	Byte 3	Byte 2	Byte 1
Example: XP31 ... XP24 MSB (most significant byte)	Example: XP23 ... XP16	Example: XP15 ... XP08	Example: XP07 ... XP00 LSB (least significant byte)

5.6 Description of the Attributes of EtherNet/IP Objects

Status: Status Word (ID 100)

Size	Type	Content
2 byte	Input data	16 bit status

If the ERR bit is set, there is an error. The error number is transferred to the "Value signed (ID 10)" attribute.

Data for attribute 100

Bit no.	Content	Function
	Byte 1, 2 Status	
1	ERR	Error message
2	NP	No position information/OUT (XP = 0, YP = 0, SP = 0)
3	WRN	Warnings present, see Warning attribute
4	CC1_#	Control code 1 or 2 detected with number #. Control code 2 is evaluated via the "SplitValue" function. ¹
5	CC2_#	
6	RL	Read head follows right lane.
7	LL	Read head follows left lane.
8	NL	No lane detected.
9	reserved	-
10	LC0	Number of visible lane (low bit).
11	LC1	Number of visible lane (high bit).
12	TAG	DataMatrix Tag detected
13	FlashOff	Status bit flash deactivated (1: flash off, 0: flash on)
14	DMCOff	DataMatrix decoder switched off
15	reserved	-
16	reserved	-

1. If you have any questions, please contact Pepperl+Fuchs.

Position/Lane

You can use the following table to draw conclusions on the current section in the reading window based on the feedback from the read head regarding Data Matrix tag **TAG**, No Lane **NL**, No X Position **NP**, absolute X position **XP** and the Y position and angle **YPS/ANG**.

Meaning of Bits

TAG	NL	NP	XP	YPS/ANG	Meaning
0	0	0	+ ¹	+	Data Matrix lane available. Position and angle refer to the Data Matrix lane.
0	1	0	+	+	Data Matrix lane available.
0	1	1	-	-	No evaluable objects exist.
1	-	0	+	+	Position on the basis of a Data Matrix tag, X position is signed.

Table 5.1 Meaning of bits

1. Valid data present

Number of Lanes LC (Lane Count)

The lane count, LC, indicates the number of found fab or Data Matrix tracks in the reading window. A variety of causes may be responsible if the lane count does not match the expected number of lanes:

LC < actual number

- Lane is not located in the reading window
- Color of the lane does not match the configured color

LC > actual number

- Contrast between the ribbon and the floor is too low

**Tip****Increase contrast**

To ensure maximum contrast between the floor and the ribbon, please note the following contrast colors:

Basic color green: contrast color red

Basic color blue: contrast color red

Basic color red: contrast color green

Meaning of Bits

LC1	LC0	Meaning
0	0	No lane found
0	1	1 lane found
1	0	2 lanes found
1	1	3 or more lanes found

Position data Y:Y position (ID 101)

Size	Type	Content
4 byte consistent	Input data	32 bit Y data LSB first Resolution: 0.1 mm, 1 mm, 10 mm, binary coded in two's complement

The following default settings apply:

- The Y position is output in the two's complement.
- The value is output in the resolution set for the device.

Warning: Warning Flags (ID 102)

Size	Type	Content
2 byte consistent	Input data	Last warnings Last warning no.

A set bit indicates that the corresponding warning is active.

Warning Data Set

Bit no.	Content	Description
1	WRN01	A code with non-read head content was found.
2	WRN02	Read head too close to code tape
3	WRN03	Read head too far from code tape
4	WRN04	Y position too large. The sensor is just before OUT
5	WRN05	Y position too small. The sensor is just before OUT
6	WRN06	Read head is rotated/tilted in relation to the code tape
7	WRN07	Low level of code contrast
8	WRN08	Repair tape detected
9	WRN09	Reserved
10	WRN10	Reserved
11	WRN11	Reserved
12	WRN12	Reserved
13	WRN13	Reserved
14	WRN14	Reserved
15	WRN15	Reserved
16	WRN16	Reserved



Note

If no warnings are present, all bits in the warning data set are set to 0.

Error: Error Flags (ID 103)

Error Codes

Error code	Description	Priority
1	Read head tilted 180°	2
2	No clear position can be determined (difference between codes is too great, code distance incorrect, etc.)	3
> 1000	Internal error	1

Angle data: Angle (ID 104)

Size	Type	Content
2 byte consistent	Input data	16 bit angle data LSB first LSB = least significant byte Resolution: 0.1°, 1° binary coded

The following default settings apply:

- The value is output in the set resolution of the device.

Position Data X: Position Value Unsigned (ID 105)

Size	Type	Content
4 byte consistent	Input data	32 bit X data LSB first LSB = least significant byte Resolution: 0.1 mm, 1 mm, 10 mm, binary coded At a resolution of 1 mm and 10 mm: $L_{\max} = 10.00 \text{ km} = 10,000,000 \text{ mm}$

The following default settings apply:

- The value is output in the resolution set for the device.
- If the ERR bit is set in the "Status word (ID 100)" attribute, the error number is transferred to this attribute.

Position Data Z: Z Distance (ID 106)

Size	Type	Content
2 byte consistent	Input data	16 bit Z data LSB first Resolution: 0,1 mm, 1 mm, 10 mm, binary coded

The following default settings apply:

- The value is output in the resolution set for the device.

ControlCode Status: CCL Status (ID 107)

Size 1 byte
Type Input data
Content 8 bit status

Bit 7	Bit 6	Bit 5	Bit 4	Bit 3	Bit 2	Bit 2	Bit 0
reserved	reserved	reserved	Illumination control	O1	O0	S1	S0

Orientation O

The orientation O indicates the orientation of the control codes in the reading window.

Meaning of Bits

O1	O0	Meaning
0	0	Control code has the same orientation as ascending Data Matrix lane
0	1	Orientation of control code rotated 90° clockwise in relation to ascending Data Matrix lane
1	0	Orientation of control code rotated 180° clockwise in relation to ascending Data Matrix lane
1	1	Orientation of control code rotated 270° clockwise in relation to ascending Data Matrix lane

Orientation

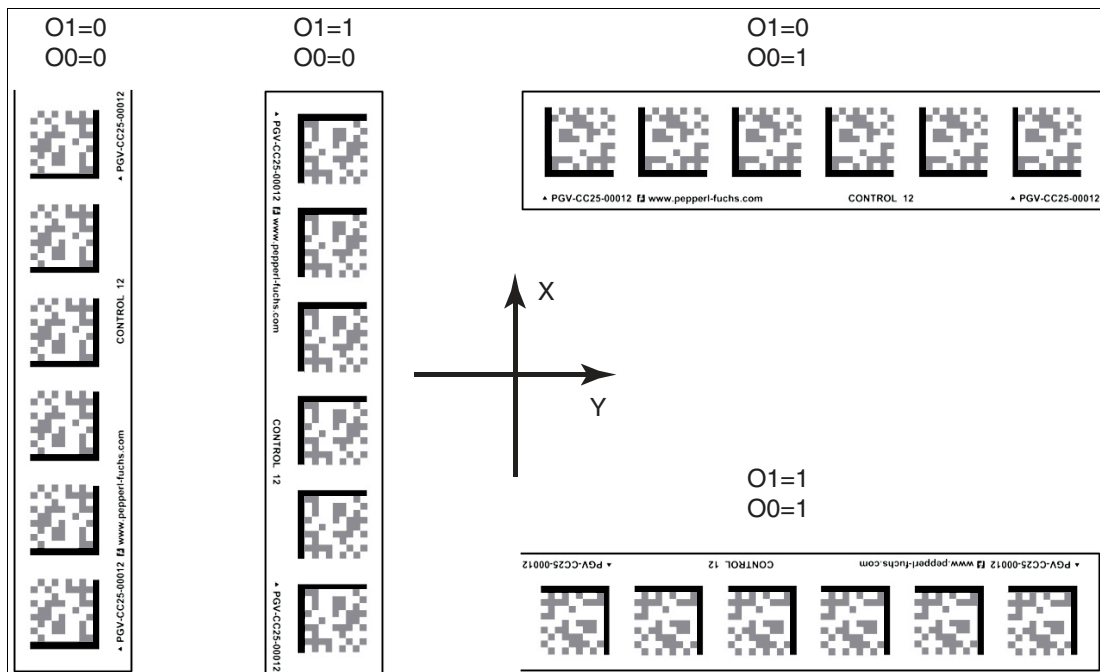

Figure 5.1 Orientation

Side S

Side S specifies the side of the Data Matrix lane on which the control codes are present.

Meaning of Bits

S1	S0	Meaning
0	0	No control code is present or found Reserved
0	1	Control code to the right of the Data Matrix lane
1	0	Control code to the left of the Data Matrix lane
1	1	Not detectable 1

1. Control code laid on Data Matrix lane, no Data Matrix lane.
 Detection left or right of the color lane not possible. Because a direction of drive can not be detected with color lane, the position can not be output.

Example

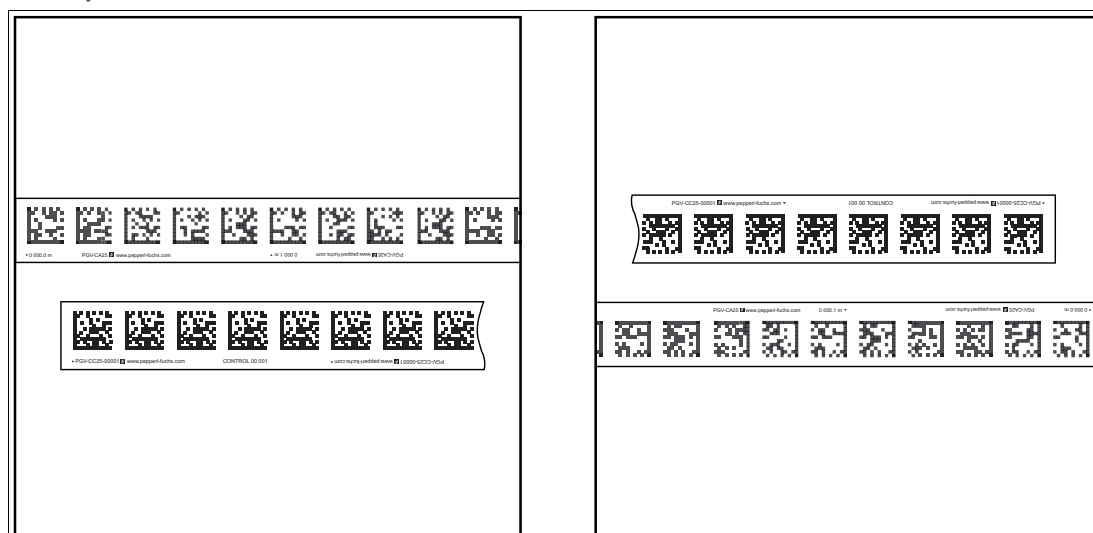

Figure 5.2 Control code **right** of the DataMatrix lane.

Control Code Wert: CCL Value (ID 108)

Größe	Typ	Inhalt
2 Byte konsistent	Eingangsdaten	16 Bit Control-Code-Wert LSB first LSB = least significant byte

TAG Wert: TAG Value (ID 109)

Size	Type	Content
4 byte consistent	Input data	32 bit TAG value LSB first LSB = least significant byte

Direction Decision: Steering Information (ID 125)

Bit 7	Bit 6	Bit 5	Bit 4	Bit 3	Bit 2	Bit 2	Bit 0
Reserved	Reserved	Reserved	Lighting control	Reserved	Reserved	Select left lane	Select right lane

Lighting control:

- 1 = flash off
- 0 = flash on

Direction selection

Bit 1 Select left lane	Bit 0 Select right lane	Direction Decision
0	0	No lane is selected Error code 5
0	1	Follow right-hand lane
1	0	Follow left-hand lane
1	1	Colored tape: follow lane with better quality Data Matrix code tape: follow lane with more detailed position information Data Matrix tag: no significance

Table 5.2

6 Appendix

6.1 ASCII table

hex	dec	ASCII	hex	dec	ASCII	hex	dec	ASCII	hex	dec	ASCII
00	0	NUL	20	32	Space	40	64	@	60	96	'
01	1	SOH	21	33	!	41	65	A	61	97	a
02	2	STX	22	34	"	42	66	B	62	98	b
03	3	ETX	23	35	#	43	67	C	63	99	c
04	4	EOT	24	36	\$	44	68	D	64	100	d
05	5	ENQ	25	37	%	45	69	E	65	101	e
06	6	ACK	26	38	&	46	70	F	66	102	f
07	7	BEL	27	39	'	47	71	G	67	103	g
08	8	BS	28	40	(48	72	H	68	104	h
09	9	HT	29	41)	49	73	I	69	105	i
0A	10	LF	2A	42	*	4A	74	J	6A	106	j
0B	11	VT	2B	43	+	4B	75	K	6B	107	k
0C	12	FF	2C	44	,	4C	76	L	6C	108	l
0D	13	CR	2D	45	-	4D	77	M	6D	109	m
0E	14	SO	2E	46	.	4E	78	N	6E	110	n
0F	15	SI	2F	47	/	4F	79	O	6F	111	o
10	16	DLE	30	48	0	50	80	P	70	112	p
11	17	DC1	31	49	1	51	81	Q	71	113	q
12	18	DC2	32	50	2	52	82	R	72	114	r
13	19	DC3	33	51	3	53	83	S	73	115	s
14	20	DC4	34	52	4	54	84	T	74	116	t
15	21	NAK	35	53	5	55	85	U	75	117	u
16	22	SYN	36	54	6	56	86	V	76	118	v
17	23	ETB	37	55	7	57	87	W	77	119	w
18	24	CAN	38	56	8	58	88	X	78	120	x
19	25	EM	39	57	9	59	89	Y	79	121	y
1A	26	SUB	3A	58	:	5A	90	Z	7A	122	z
1B	27	ESC	3B	59	;	5B	91	[7B	123	{
1C	28	FS	3C	60	<	5C	92	\	7C	124	
1D	29	GS	3D	61	=	5D	93]	7D	125	}
1E	30	RS	3E	62	>	5E	94	^	7E	126	~
1F	31	US	3F	63	?	5F	95	_	7F	127	DEL

Your automation, our passion.

Explosion Protection

- Intrinsic Safety Barriers
- Signal Conditioners
- FieldConnex® Fieldbus
- Remote I/O Systems
- Electrical Ex Equipment
- Purge and Pressurization
- Industrial HMI
- Mobile Computing and Communications
- HART Interface Solutions
- Surge Protection
- Wireless Solutions
- Level Measurement

Industrial Sensors

- Proximity Sensors
- Photoelectric Sensors
- Industrial Vision
- Ultrasonic Sensors
- Rotary Encoders
- Positioning Systems
- Inclination and Acceleration Sensors
- Fieldbus Modules
- AS-Interface
- Identification Systems
- Displays and Signal Processing
- Connectivity

Pepperl+Fuchs Quality

Download our latest policy here:

www.pepperl-fuchs.com/quality

