With regard to the supply of products, the current issue of the following document is applicable: The General Terms of Delivery for Products and Services of the Electrical Industry, published by the Central Association of the Electrical Industry (Zentralverband Elektrotechnik und Elektroindustrie (ZVEI) e.V.) in its most recent version as well as the supplementary clause: "Expanded reservation of proprietorship"

Worldwide

Pepperl+Fuchs Group
Lilienthalstr. 200
68307 Mannheim
Germany
Phone: +49 621 776 - 0
E-mail: info@de.pepperl-fuchs.com

North American Headquarters

Pepperl+Fuchs Inc.
1600 Enterprise Parkway
Twinsburg, Ohio 44087
USA
Phone: +1 330 425-3555
E-mail: sales@us.pepperl-fuchs.com

Asia Headquarters

Pepperl+Fuchs Pte. Ltd.
P+F Building
18 Ayer Rajah Crescent
Singapore 139942
Phone: +65 6779-9091
E-mail: sales@sg.pepperl-fuchs.com
<https://www.pepperl-fuchs.com>

1	Introduction.....	4
1.1	Content of this Document.....	4
1.2	Target Group, Personnel	4
1.3	Symbols Used	5
2	Product Description	6
2.1	Use and Application	6
2.2	USB Interface	7
2.3	SSI Interface	7
2.4	LED Indicators and Controls	8
2.5	Accessories.....	10
3	Installation.....	11
3.1	Affixing the Code Tape	11
3.2	Mounting the Reader	13
3.3	Electrical Connection	15
4	Commissioning.....	17
4.1	Aligning the Read Head	17
4.2	Parameterization.....	19
4.2.1	Internal Parameterization Using Parameterization Software.....	19
4.2.2	External Parameterization Using Code Cards	20
4.2.2.1	The code cards "CANCEL", "USE", and "DEFAULT"	21
5	Operation and communication.....	22
5.1	Communication via the SSI Interface	22
6	Appendix	24
6.1	Code Cards for External Parameterization.....	24
6.1.1	Code Cards with Special Functions	24
6.1.2	Code Cards for Adjusting the Resolution	27
6.1.3	Code Cards for Setting the Orientation	29
6.1.4	Code cards for setting the transfer rate	30
6.1.5	Code Cards for Adjusting Input/Output 3	32

1 Introduction

1.1 Content of this Document

This document contains information required to use the product in the relevant phases of the product life cycle. This may include information on the following:

- Product identification
- Delivery, transport, and storage
- Mounting and installation
- Commissioning and operation
- Maintenance and repair
- Troubleshooting
- Dismounting
- Disposal



Note

For full information on the product, refer to the further documentation on the Internet at www.pepperl-fuchs.com.

The documentation comprises the following parts:

- This document
- Datasheet

In addition, the documentation may comprise the following parts, if applicable:

- EU-type examination certificate
- EU declaration of conformity
- Attestation of conformity
- Certificates
- Control drawings
- Instruction manual
- Other documents

1.2 Target Group, Personnel

Responsibility for planning, assembly, commissioning, operation, maintenance, and dismounting lies with the plant operator.

Only appropriately trained and qualified personnel may carry out mounting, installation, commissioning, operation, maintenance, and dismounting of the product. The personnel must have read and understood the instruction manual and the further documentation.

Prior to using the product make yourself familiar with it. Read the document carefully.

1.3 Symbols Used

This document contains symbols for the identification of warning messages and of informative messages.

Warning Messages

You will find warning messages, whenever dangers may arise from your actions. It is mandatory that you observe these warning messages for your personal safety and in order to avoid property damage.

Depending on the risk level, the warning messages are displayed in descending order as follows:



Danger!

This symbol indicates an imminent danger.

Non-observance will result in personal injury or death.



Warning!

This symbol indicates a possible fault or danger.

Non-observance may cause personal injury or serious property damage.



Caution!

This symbol indicates a possible fault.

Non-observance could interrupt the device and any connected systems and plants, or result in their complete failure.

Informative Symbols



Note

This symbol brings important information to your attention.



Action

This symbol indicates a paragraph with instructions. You are prompted to perform an action or a sequence of actions.

2 Product Description

2.1 Use and Application

The **Data Matrix Positioning System** is the positioning system in the Pepperl+Fuchs incident light process. The heart of the system is the reader, which has features including a camera module with an integrated illumination unit. This enables the reader to detect position markers printed onto a self-adhesive code tape in the form of 2-D **Data Matrix codes**.

The **code tape** is mounted on a fixed part of the plant (e.g., the wall of an elevator shaft or the rail on a monorail conveyor). The reader is mounted on a moving "vehicle" positioned in parallel with the code tape (e.g., on the elevator cab or on the chassis of a monorail conveyor).

Maximum Length of the Code Tape

Resolution of the Reader [mm]	Maximum length of the Code Tape [km]
10	10
1	10
0.1	1.5

The code tape length of up to 10 km is sufficient for even very large applications. It also offers sufficient reserves for extensions or systems with several branches and parallel conveyor routes.

The extensive yet user-friendly parameterization options as well as the freely configurable inputs and outputs mean that the reader can easily be adapted to suit each application.

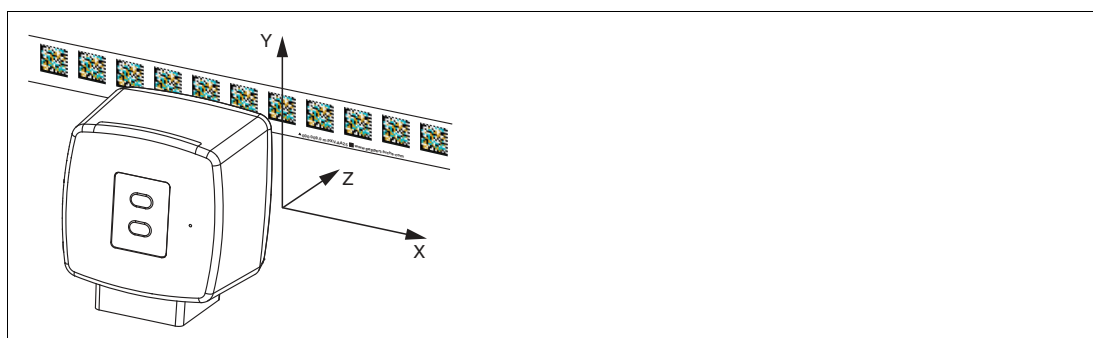

Figure 2.1 Schematic diagram of the alignment of the code tape and reader

2.2 USB Interface

The **Vision Configurator** is a useful and easy-to-use piece of configuration software for configuring the reader. This configuration software is available as a free download from www.pepperl-fuchs.com. Follow the instructions that appear on your screen during the installation.

Use the parameterization cable (see Accessories) to establish the requisite connection to the PC and to power the reader. The parameterization cable also provides the electrical supply for the reader during the parameterization process. The reader is connected to the "Service" connector.



Connecting the Service Interface

1. First connect the round plug connector to the reader.
2. Connect the plug-in power supply to the parameterization cable.
3. Connect the plug-in power supply to a socket.
↳ The ring light of the reader and the LED2 "PWR/ADJ/ERR/NO CODE" lights up continuously or flashes.
4. Now connect the USB plug-in connector to your PC.

2.3 SSI Interface

The controller and reader communicate via the SSI interface during operation. This is an optically isolated RS422 interface. The controller sends a series of pulses via the clock+ and clock- lines, and the reader responds synchronously with the 25-bit comprehensive response telegram. You can define the structure and content of the response telegram using the **Vision Configurator** configuration software.

This may include position data in an X- and Y-direction as well as speed and diagnostic data. During live operation, the reader is connected for communication via the SSI interface using the "Main" connector.

2.4 LED Indicators and Controls

The reader has seven indicator LEDs for carrying out visual function checks and rapid diagnosis.

Using the two control buttons on the rear of the device, you can activate the alignment aid and the parameterization mode.

Button 1 is labeled "ADJUST." Button 2 is labeled "CONFIG."

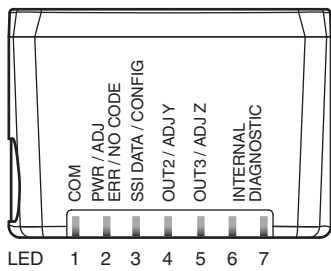
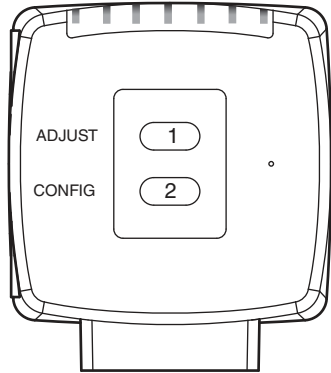

LED	[#1] COM	[#2] PWR/ADJ ERR/NO CODE	[#3] SSI DATA/CONFIG	[#4] OUT 2/ADJ Y	[#5] OUT 3/ADJ Z	[#6] +[#7] Internal diagnostics		Description
Color	Yellow	Green/ red	yellow	yellow	yellow	yellow	yellow	
Status	Off	Flashes green	Off	Off	Off	Off	Off	Alignment Y > setpoint value f _{flash} = 2 Hz
	Off	Flashes green	Off	On	Off	Off	Off	Alignment Y < setpoint value f _{flash} = 2 Hz
	Off	Flashes green	Off	Flashes	Off	Off	Off	Alignment Y = setpoint value f _{flash} = 2 Hz
	Off	Flashes green	Off	Off	Off	Off	Off	Alignment Z > setpoint value f _{flash} = 2 Hz
	Off	Flashes green	Off	Off	On	Off	Off	Alignment Z < setpoint value f _{flash} = 2 Hz
	Off	Flashes green	Off	Off	Flashes	Off	Off	Alignment Z = setpoint value f _{flash} = 2 Hz
	Off	Flashes red	Off	Off	Off	Off	Off	Alignment Code tape outside read range f _{flash} = 2 Hz
	Off	Lights up red	Off	Off	Off	Off	Off	System error
	Off	Lights up green	Flashes	x	x	Off	Off	Normal operation, SSI communication active f _{flash} = 2 Hz LEDs marked with x indicate the status of the relevant output.
	Off	Flashes red	Flashes	x	x	Off	Off	No code within read range, communication active f _{flash} = 2 Hz LEDs marked with x indicate the status of the relevant output.
	Off	Flashes red	Off	x	x	Off	Off	No code within read range, no SSI communication f _{flash} = 2 Hz LEDs marked with x indicate the status of the relevant output.
	Flashes	Flashes red	Flashes	Flashes	Flashes	Off	Off	Normal operation. Indication for two seconds if a button is pressed when the time lock is enabled.
	Off	Off	Flashes	Off	Off	Off	Off	Configuration mode active f _{flash} = 2 Hz

2020-04

LED	[#1] COM	[#2] PWR/ADJ ERR/NO CODE	[#3] SSI DATA/CONFIG	[#4] OUT 2/ADJ Y	[#5] OUT 3/ADJ Z	[#6] +[#7] Internal diagnostics		Description
Color	Yellow	Green/ red	yellow	yellow	yellow	yellow	yellow	
	Off	Red, 3 sec	Flashes	Off	Off	Off	Off	Code card faulty $f_{\text{flash}} = 2 \text{ Hz}$
	Off	Green, 1 sec	Flashes	Off	Off	Off	Off	Code card detected $f_{\text{flash}} = 2 \text{ Hz}$
	x	Off	x	x	x	Off	Off	Time lock for buttons disabled
	Flashes	Green	Off	Off	Off	Off	Off	Position query via USB interface, code within the read range
	Flashes	Flashes red	Off	Off	Off	Off	Off	Position query via USB interface, no code within read range
	x	x	x	x	x	Lights up	Lights up	Internal error Return to Pepperl+Fuchs

x = LED status has no meaning.

2.5 Accessories

Compatible accessories offer you potential for cost savings when commissioning, replacing, and servicing our products.

If products are used in harsh ambient conditions, appropriate Pepperl+Fuchs accessories can be used to extend the service life of these products.

Model number	Description
PXV*-AA25-*	2-colored Data Matrix code tape, total length up to 100,000 m. Minimum length of 1 m, start position and length indicated in meters
V19-G-ABG-PG9-FE	Grounding terminal and plug (set)
PCV-KBL-V19-STR-USB	Cable unit for service interface with power supply
VAZ-V1S-B	Cap for service connector
PCV-MB1	Mounting bracket
Vision Configurator	Configuration software

Suitable connection cables can be found in the Accessories section of the reader datasheet at www.pepperl-fuchs.com.

3 Installation

3.1 Affixing the Code Tape

Dimensions of the Code Tape

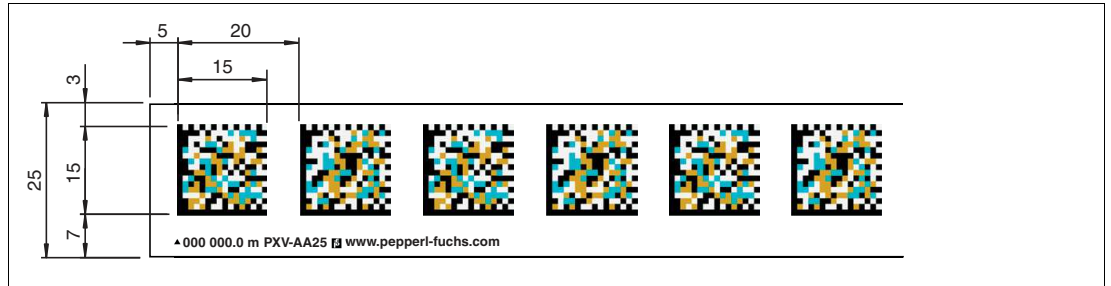

The code tape is made of silicone-free polyester film. A position marker appears every 100 mm along the lower edge of the code tape (see "Code Tape Dimensions"). These position markers are used to affix the code tape in the correct position.

The back of the code tape is covered with a modified acrylate-based adhesive designed for permanent adhesion. Affix the self-adhesive code tape along the desired traverse distance. To do so, proceed as follows:



Affixing the Code Tape

1. Clean the surface of any greasy or oily deposits and dust.
2. Ensure that the surface is dry, clean, and stable.
3. Pull away a few centimeters of the protective film at the beginning of the code tape. Place the code tape at the precise point of the required starting position on the surface, and press to attach.
4. Then affix the code tape along the desired traverse distance. Remove the protective film gradually so that the code tape does not accidentally adhere to the surface in the incorrect position. When affixing, ensure that the code tape does not crease or trap air bubbles.

↳ The adhesive on the code tape hardens after 72 hours.



Note

Thermal Expansion of the Code Tape

The heat expansion coefficient of the adhered code tape corresponds to the heat expansion coefficient of the underside.

Code Tapes with a Starting Position of 0 m

Order Designation	Description
PXV00001-AA25-*	Code tape, 1-track, length: 1 m
...	...
PXV100000-AA25-*	Code tape, 1-track, length: 100,000 m



Note

Expansion Joints and Code Tapes

If the system covers longer distances, expansion joints are integrated in the system structure. We recommend creating breaks along the code tape. The resulting gap must not exceed 75 mm.

**Note****Inclines and Declines**

If you affix the code tape on inclines or declines, cut the code tape several times at the transition point to the horizontal as shown.



Figure 3.1 Schematic diagram: preparing Data Matrix code tape bends

1. Bend to the left
2. Bend to the right

If the reader leaves the zero line when traversing along the X-axis, the threshold may deviate. If the deviation exceeds the defined threshold, a warning code is issued.

3.2 Mounting the Reader



Mounting the Reader—The Process

Make sure that you can mount the reader such that it has a stable position. Prior to mounting the reader, make sure that the guidance of the moving system component is such that the reader depth of focus range is not exited during operation.

1. Secure the reader to the moving component of your system via the four screws on the reader mounting adapter.
2. Mount the reader **vertically** so that the lens with ring light and camera module are aligned toward the code tape.

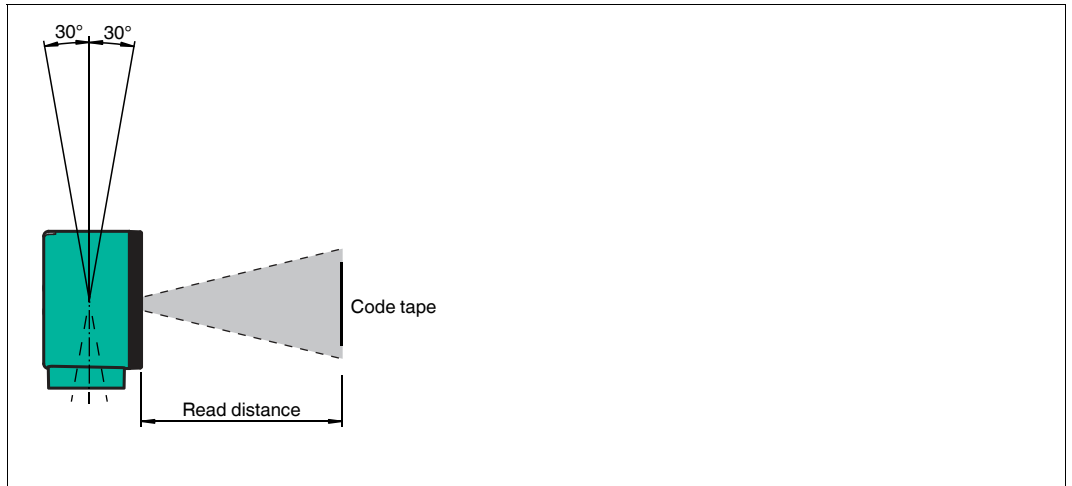

Figure 3.2 Vertical alignment tolerance

3. Alternatively, mount the reader **horizontally** so that the lens with ring light and camera module are aligned toward the code tape.

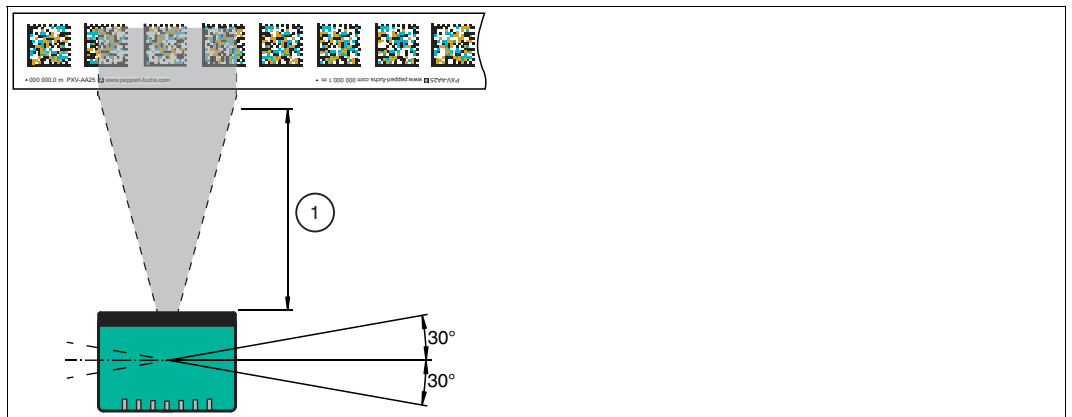

Figure 3.3 Toleranz horizontale Ausrichtung

1. Read Distance

2. Check that the distance from the reader to the code tape is the same as the read distance of the reader:

Optimal Read Distance (Z-Axis)

Model number	Read distance [mm]	Depth of focus [mm]
PXV100AS*	100	± 30

Reader Dimensions

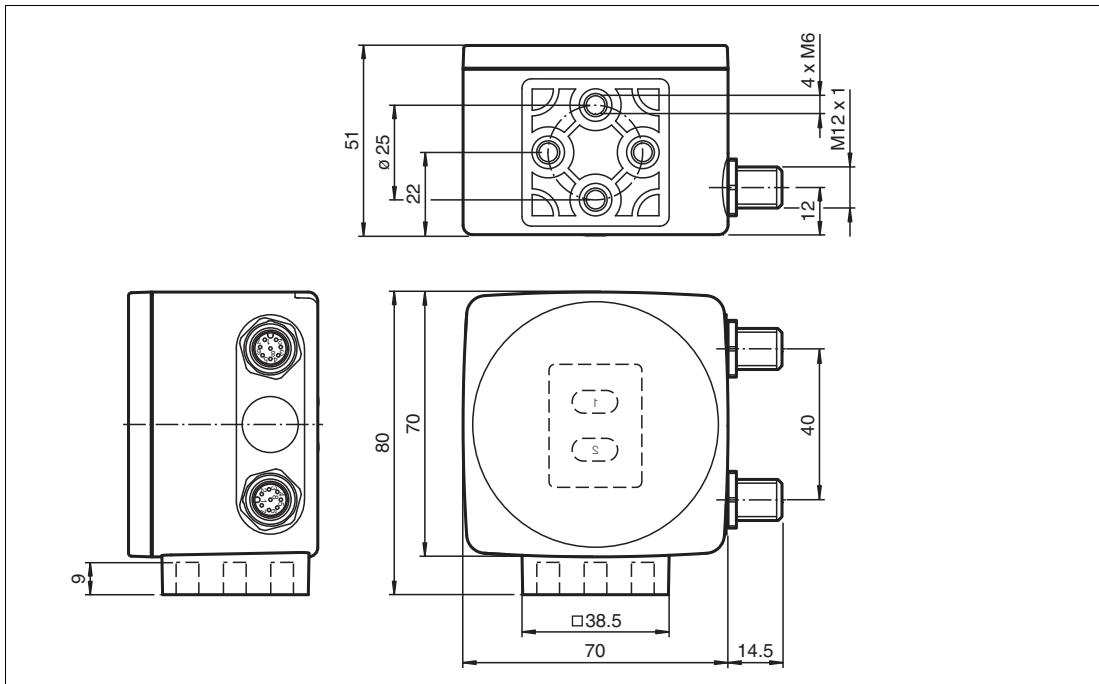

Caution!

When selecting the length of the mounting screws, ensure that the maximum insertion depth of the screws in the threaded inserts on the reader is 8 mm.

Using longer screws can damage the reader.



Caution!

The maximum torque of the mounting screws must not exceed 9 Nm.

Tightening the screws to a higher torque can damage the reader.

3.3 Electrical Connection

The reader is connected to an 8-pin M12 x 1 connector plug at the side of the housing with the label "Main". The power supply and communication with the SSI interface is established via this connection. The configurable inputs and outputs on the reader are also located at this connection.



Figure 3.4 Electrical Connection

Connections 1 and 8 can be configured as inputs or outputs.

Connector Assignment



Figure 3.5 Connector assignment

Color Assignment

Single-ended female cordsets by Pepperl+Fuchs are manufactured in accordance with EN60947-5-2. When using a type V19-... single-ended female cordset with an open cable end (), the following color assignment applies:

Connection pin	Strand color	Color abbreviation
1	White	WH
2	Brown	BN
3	Green	GN
4	Yellow	YE
5	Gray	GY
6	Pink	PK
7	Blue	BU
8	Red	RD



Note

"Service" Plug Connector

The plug connector marked with "Service" is used only to set the parameters of the reader. Communication with the PC on which the configuration software is running and the power supply itself are both fed through the parameterization cable (cable unit for service interface with the power supply). A description of the connection can be found in the "Vision Configurator" configuration software manual.

Shielding Cables

The shielding of connection lines is required to suppress electromagnetic interference. Establishing a low resistance or low impedance connection with the protective conductor or equipotential bonding circuit is a particularly important factor in ensuring that these interference currents do not become a source of interference themselves. Only use connection lines with braid. Avoid connection lines with foil shield because this would increase the line capacities. The shielding is integrated at both ends, i.e., in the switch cabinet or on the PLC, **and** on the read head. The grounding terminal available as an accessory allows easy integration in the equipotential bonding circuit.

In exceptional cases, the shielding of a connection at one end may be more favorable if:

- An equipotential bonding cable is not laid or cannot be laid.
- A film shield is used.

The following points relating to shielding must be noted:

- Use metal cable clips that cover large areas of the shielding.
- Place the cable shield onto the equipotential bonding rail immediately on entering the switch cabinet.
- Direct the protective grounding connections to a common point in a star configuration.
- The cross-section of the cables used for grounding should be as large as possible.

Additional Ground Connection

Model number	Description
PCV-SC12	Clip for mounting an additional ground connection.



Caution!

Damage to the device

Connecting an alternating current or excessive supply voltage can damage the device or cause the device to malfunction.

Electrical connections with reversed polarity can damage the device or cause the device to malfunction.

Connect the device to direct current (DC). Ensure that the supply voltage rating is within the specified device range. Ensure that the connecting wires on the female cordset are connected correctly.

4 Commissioning

4.1 Aligning the Read Head

An integrated alignment aid is available to help you align the Y and Z coordinates of the read head easily and precisely with respect to the code reel.



Note

The activation of the alignment aid is possible only within 10 minutes of switching on the read head.

The switchover from normal operation to parameterization mode is via button 1 on the back of the read head.



Activating the Alignment Aid

1. Press button 1 for longer than 2 seconds.
 ↳ LED2 flashes green for a recognized code reel. LED2 flashes red for an unrecognized code reel. .
2. Align the Z and Y coordinates of the read head. The integral LED indicators provide assistance here.

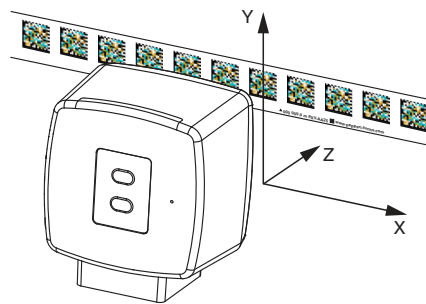

Z coordinate: If the distance of the camera to the code reel is too small, the yellow LED5 lights up. If the distance is too great, the yellow LED5 goes out. The yellow LED5 flashes at the same time as the green LED2 when within the target range. .

Set the distance between the read head and the code reel so that the yellow LED5 and the green LED2 flash synchronously.



Figure 4.1 Z orientation

Y coordinate: If the optical axis of the read head is too low relative to the middle of the code reel, the yellow LED4 lights up. If the optical axis is too high, the yellow LED4 goes out. Within the target range, the yellow LED4 flashes at the same time as the green LED2. Set the optimal height of the read head relative to the code reel so that the yellow LED4 flashes in rhythm with the green LED2. Briefly pressing button 1 ends the alignment aid, and the read head returns to normal operation.

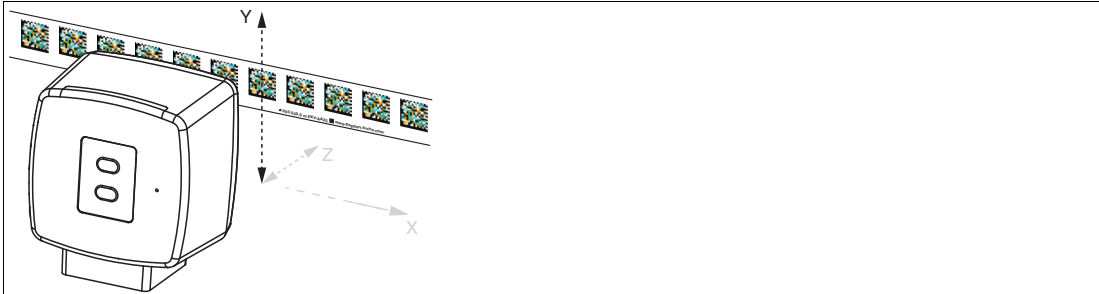

Figure 4.2 Y orientation

4.2 Parameterization

The reader can be adapted to optimally meet specific requirements through parameterization. The reader can be parameterized via the service interface (internal parameterization) or via an optical parameterization code (external parameterization).

4.2.1 Internal Parameterization Using Parameterization Software

Internal parameterization of the reader via the USB interface must be started within 10 minutes of the reader being switched on. A time lock disables the reader once this time has elapsed. The time lock remains inactive during the parameterization process. The time lock disables the reader only if no parameterization activities take place for more than 10 minutes.

The **Vision Configurator** software is available for comprehensive, optimal configuration of the reader. This configuration software is available as a free download from www.pepperl-fuchs.com. Follow the instructions that appear on your screen during the installation.



Connecting the Service Interface

1. 1. First connect the round plug connector to the reader.
2. 2. Connect the plug-in power supply to the parameterization cable.
3. 3. Connect the plug-in power supply to a socket.

↳ The ring light of the reader and the LED2 "PWR/ADJ/ERR/NO CODE" lights up continuously or flashes.

4. 4. Now connect the USB plug-in connector to your PC.



Configuring the Reader

1. Start the "Vision Configurator" software.



Note

Additional easy-to-follow steps for installing the software are described in the **Vision Configurator** manual. The Vision Configurator manual can be found online at www.pepperl-fuchs.com.

2. Configure the reader using the "Vision Configurator" software.
3. Transfer the parameter list to the reader.
4. Save the parameterization.
5. Switch off the power supply on the reader.
6. Remove the USB plug for the parameterization cable from your PC.
7. Remove the parameterization cable from the reader and connect the round plug connector for the service interface to the stopping plug.

↳ The reader is now configured according to your specifications and can be used in your application.

4.2.2 External Parameterization Using Code Cards

During external parameterization, the reader scans special code cards optically and configures the relevant parameters. Simply hold the corresponding code cards at the correct distance in front of the lens on the reader. The standard code cards are contained in the appendix.

The following parameters can be configured using code cards:

- Output code [binary, gray]
- Reading head resolution [0.1 mm, 1 mm, 10 mm]
- Trigger source [auto, hardware]
- Function of the input/output 2 [as input: None, trigger input/as output: None, overspeed, warning, error, dirt, event, no position]
- Function of input/output 3 [as input: none, trigger input/as output: none, overspeed, warning, error, dirt, event, no position]

Activating the Programming Mode

Note

External parameterization of the reader using code cards must be started within 10 minutes of the reader switching on. A time lock disables the reader once this time has elapsed. The time lock remains inactive during the parameterization process. The time lock disables the reader only if no parameterization activities take place for more than 10 minutes.

If a button is pressed when the time lock is enabled, all LEDs flash and remain lit for two seconds during each flashing cycle.

The switchover from normal mode to parameterization mode is made by pressing button 2 on the back of the reader.

Activating parameterization mode

1. Press button 2 for longer than 2 seconds.
↳ This will cause yellow LED3 to flash.
2. Hold the "ENABLE" code in front of the camera system on the reader to trigger final activation
↳ If the "ENABLE" activation code is detected, the green LED2 lights up for 1 second. If the activation code is not detected, LED2 lights up red for 2 seconds.

Carrying out parameterization

Place the parameterization code in the field of vision of the camera module.

↳ After the parameterization code is detected, the green LED2 lights up for 1 second. In the event of an invalid parameterization code, LED2 lights up red for 2 seconds.

Exiting parameterization mode

Hold the "STORE" code in front of the camera system on the reader to save the configuration

↳ When the "STORE" memory code is detected, the green LED2 lights up for 1 second. The parameterization is stored in the nonvolatile memory of the reader and parameterization mode is terminated. Parameterization of the reader is now complete. If the memory code is not detected, LED2 lights up red for 2 seconds.

Note

Tap button 2 to exit parameterization mode. Any parameter changes that are made but have not yet been saved are discarded. The reader operates with the last valid parameters that were saved.

4.2.2.1 The code cards "CANCEL", "USE", and "DEFAULT"

Holding one of these cards in front of the reading head exits parameterization mode with the following consequences:

- **CANCEL:**

All parameter changes that are made but have not yet been saved are discarded. The reading head operates with the last valid parameters that were saved.

- **USE:**

For test purposes, the reading head operates with the parameters that have just been modified. The parameterization is not saved, however. After being switched off and on again, the reading head operates with the last valid parameters that were saved.

- **DEFAULT:**

All parameters in the reading head are overwritten with the original default settings. Re-enter the configuration mode and save the default settings nonvolatile with the code card STORE.

5 Operation and communication

5.1 Communication via the SSI Interface

The reader has an SSI interface that enables it to read the current process data during operation. This is an optically isolated RS422 interface. The controller sends a start sequence, and the reader responds synchronously with the 25 bit comprehensive data telegram.

SSI pulse diagram

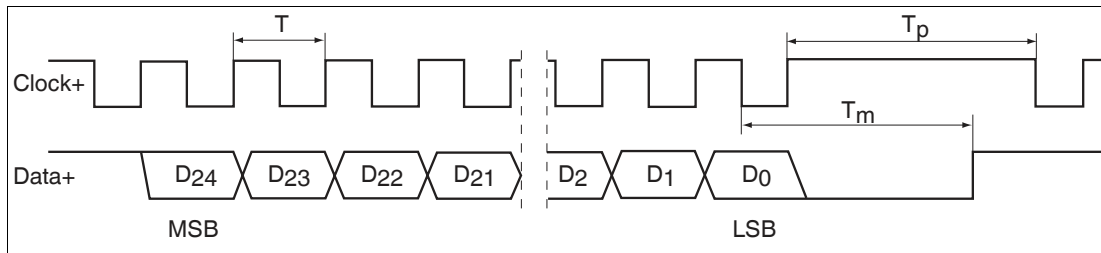

- T: Duration of the pulse signal
- T_p : Pause time of the pulse signal
- T_m : Monoflop time
- D24 ... D0: Data bits
- MSB: Most important data bit (Most Significant Bit)
- LSB: Least important data bit (Least Significant Bit)

SSI output format, standard

In an idle state, the “Data +” and “Clock +” signal cables are set to high (3.3 V) and the “Data -” and “Clock -” signal cables are set to low (-3.3 V). When the pulse signal changes from high to low for the first time, the current status (e.g. position data, error codes, etc.) is stored temporarily to initiate the data transfer. With the first rising pulse edge, the most important data bit D_{24} (MSB) is available at the serial data output on the reading head. The next most important data bit is then transferred with every additional rising pulse edge. When the least important data bit D_0 (LSB) has been transferred, the data cable switches to low until the monoflop time T_m has elapsed. A further data transfer can only be initiated when the data cable switches to high again or the pulse interval time T_p has elapsed. At the end of the pulse sequence, the last falling pulse edge triggers the monoflop time T_m . The monoflop time T_m determines the lowest transfer frequency.

SSI output format, dual request (slide valve mode)

With dual requests, the same data word is transferred several times via the SSI interface to allow the detection of transmission errors. During multiple transfers, 25 bits are transferred for each data telegram. If the pulse change is not interrupted after the last falling pulse edge, slide valve mode is activated automatically, which means that the information stored temporarily during the first pulse change is transmitted again. After the first transfer, the 26th pulse controls the repeat transfer of data.

Therefore, if the 26th pulse occurs after a time shorter than the monoflop time T_m , the same data word is transmitted again. If the 26th pulse occurs after a time longer than the monoflop time T_m , this represents the 1st pulse in a new query sequence and the pulses that follow transmit a new, updated data word.

Note

If the clock line is inverted, the data word is moved.



You can define the structure and content of the response telegram using the configuration software **Vision Configurator**. This may include position data in an X- and Y-direction as well as speed and diagnostic data. Make sure that the required settings have been configured, transmitted to the reader, and stored there. The factory default structure of the response telegram is as follows:

Bit	25	24	23	22	21	20	19	18	17	16	15	14	13	12	11	10	9	8	7	6	5	4	3	2	1
Data	XP21	XP20	XP19	XP18	XP17	XP16	XP15	XP14	XP13	XP12	XP11	XP10	XP9	XP8	XP7	XP6	XP5	XP4	XP3	XP2	XP1	XP0	Out	Wrn	Err
	MSB																					LSB	Status bits		



Note

The number of position bits required in the X-direction depends on the track length of your system and the required position resolution.

Example:

max. track length = 300 m, required position resolution = 1 mm.

19 bits are enough to display the X position. You can therefore assign 6 bits to display additional data.

Meaning of status bits:

Out	Wrn	Err	Meaning
x	1	x	Reserved
x	x	1	Error, error code in XP0 ... XP21
1	x	x	No position codes in the read window (XP0 ... XP21=0)

Error codes:

Error code	Meaning
1	Reader aligned incorrectly (rotated 180°)
2	Position error: Position codes in the read window are not unique
>1000	Internal fault

6 Appendix

6.1 Code Cards for External Parameterization

Here, you can find the code cards that enable you to parameterize some basic read head functions step by step. For the exact external parameterization procedure .



Note

When performing external parameterization with code cards, we recommend copying and printing out the relevant pages in this manual and cutting out the code cards. This prevents the read head from mistakenly detecting another code card on the same page. If you intend to use this manual directly for parameterization, cover the code cards that you do not require with a sheet of paper, for example.

6.1.1 Code Cards with Special Functions

The following code cards have special functions:

- ENABLE
- STORE
- CANCEL
- USE
- DEFAULT

Enable

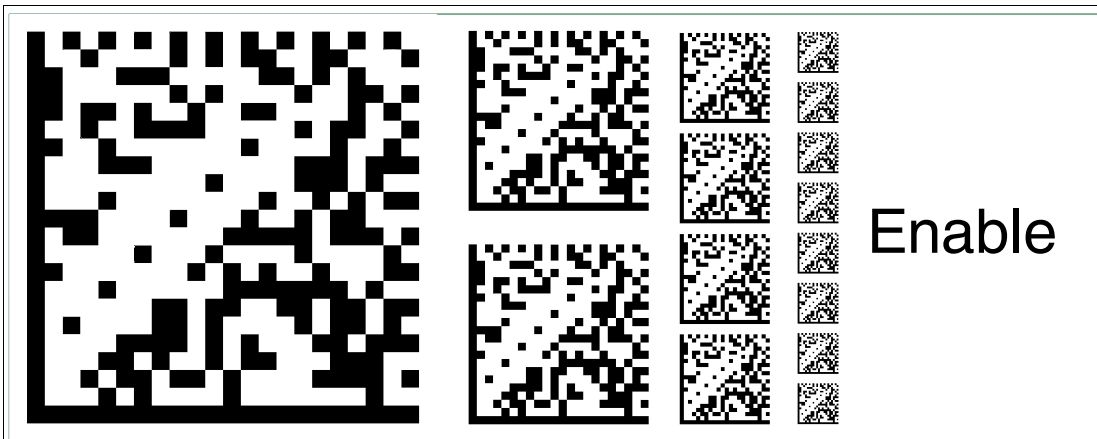

Figure 6.1 The code card "ENABLE" is used to activate external parameterization operating mode.

Store

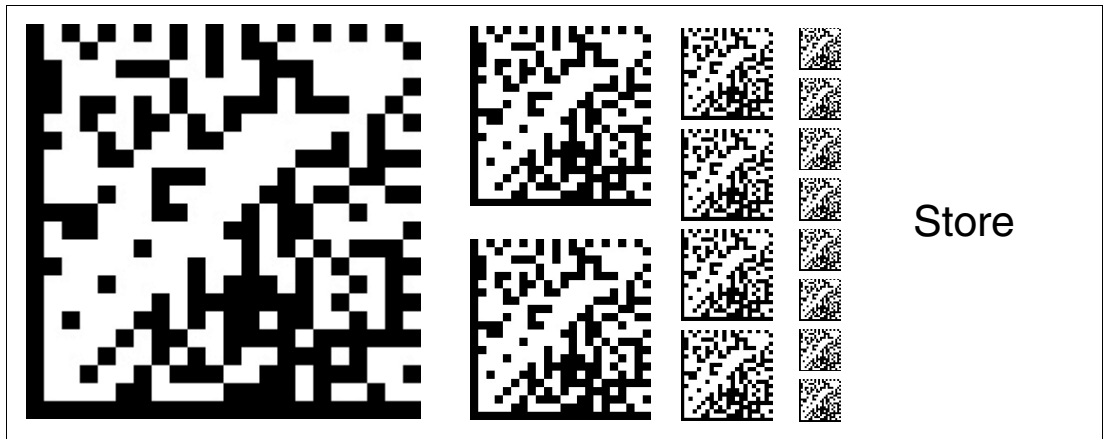

Figure 6.2 The "STORE" code card stores the modified parameterization in the nonvolatile memory of the read head and terminates external parameterization operating mode.

Cancel

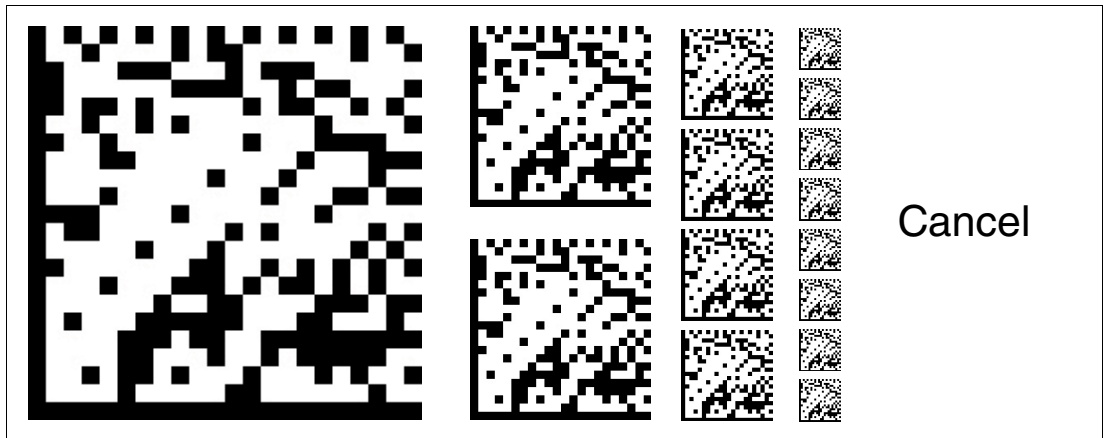

Figure 6.3 The "CANCEL" code card discards the modified parameterization and terminates external parameterization operating mode. The read head switches to normal mode and adopts the last valid configuration that was saved.

Use

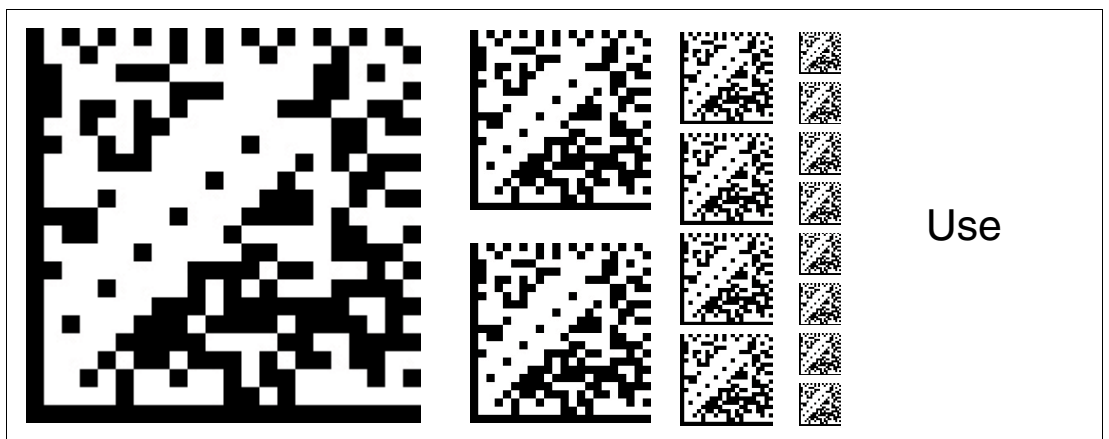

Figure 6.4 The "USE" code card takes over the set configuration **volatile** in the read head working memory and terminates the external parameterization operating mode. The read head then operates with this configuration. However, if the read head is switched off and on again, the configuration is lost and the read head operates with the last valid configuration that was saved. This function is used primarily for test purposes.

Default

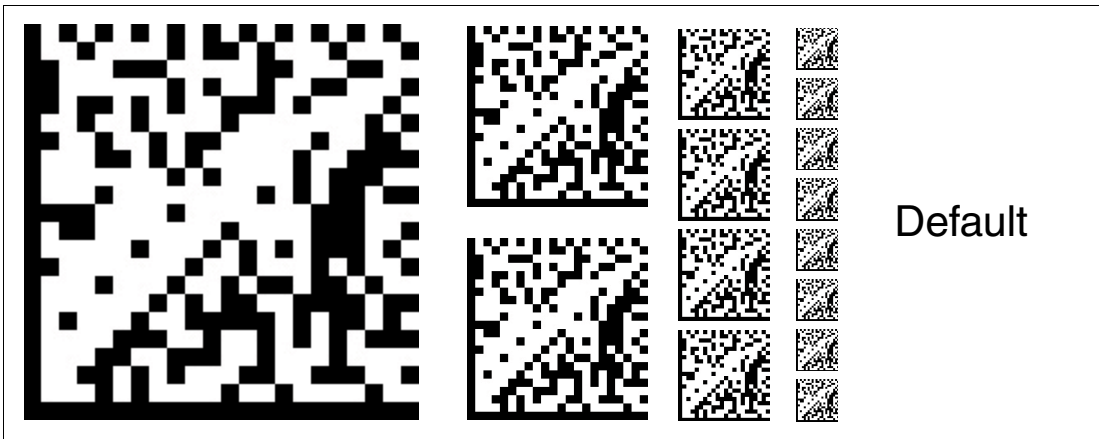

Figure 6.5 The "DEFAULT" code card restores the settings of the read head to default and terminates external parameterization operating mode.

6.1.2 Code Cards for Adjusting the Resolution

Parameterization enables you to assign a position data resolution of 0.1 mm / 1 mm / 10 mm to the read head.

Resolution: 0.1 mm

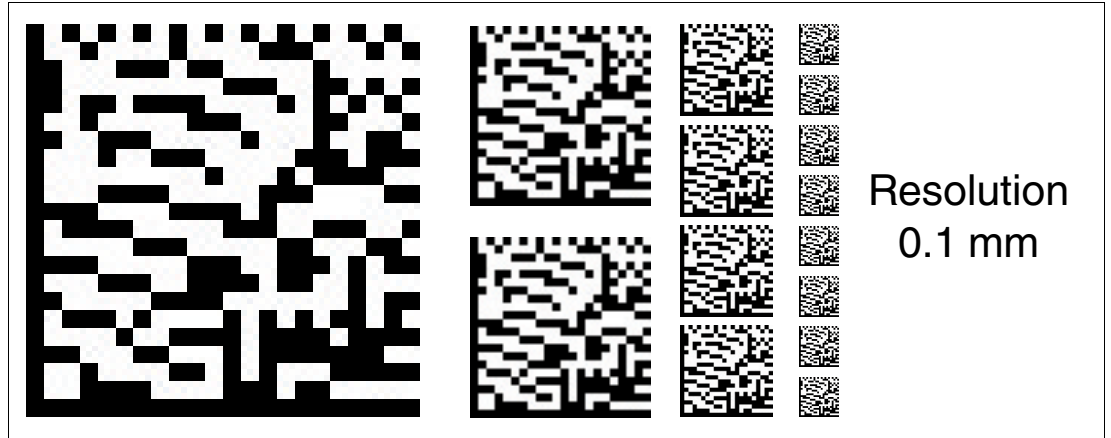

Figure 6.6 The code card assigns a position data resolution of 0.1 mm to the read head.

Resolution: 1 mm

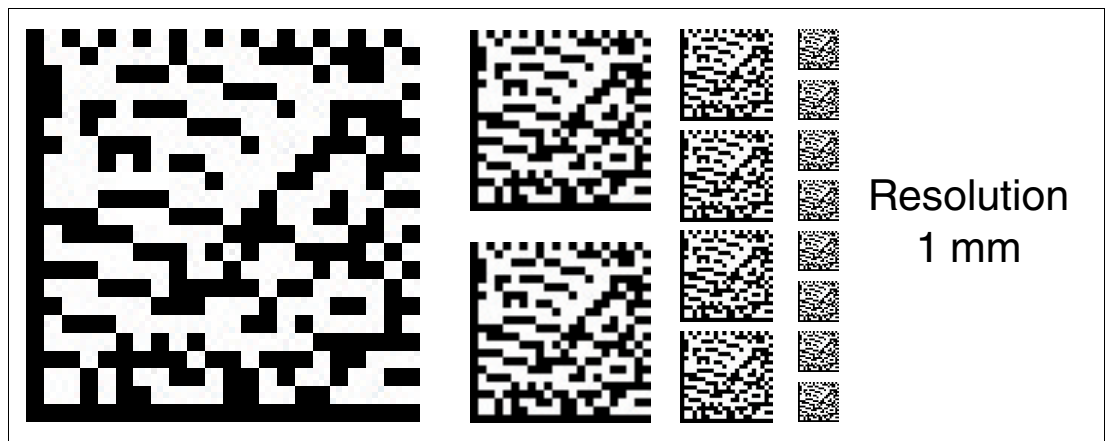

Figure 6.7 The code card assigns a position data resolution of 1 mm to the read head.

Resolution: 10 mm

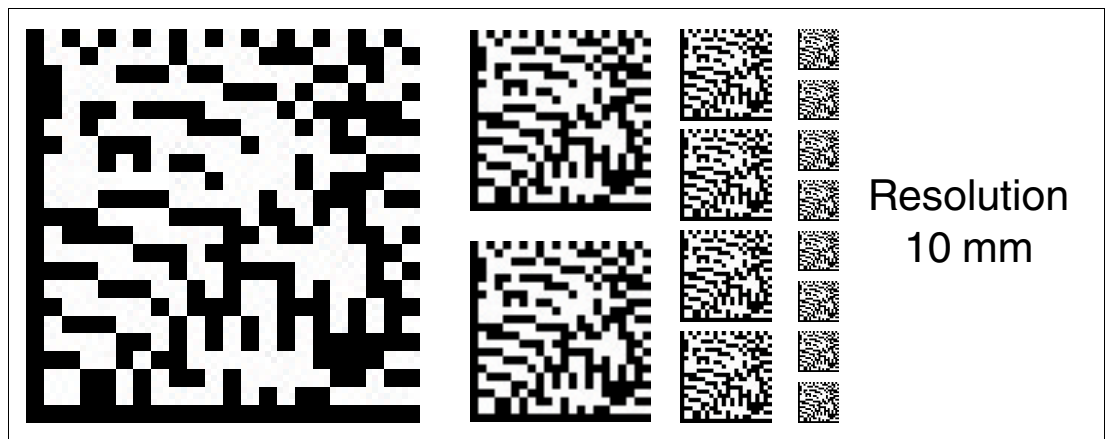

Figure 6.8 The code card assigns a position data resolution of 10 mm to the read head.

Maximum Length of the Code Tape

Resolution of the read head [mm]	Maximum length of the code tape [km]
10	10
1	10
0.1	10

6.1.3 Code Cards for Setting the Orientation

If the alignment of the read head to the code tape does not correspond to the default setting, the orientation must be adjusted. The orientation can be set at an angle of 0°, 180°, or 0°/180°.

Orientation 0°

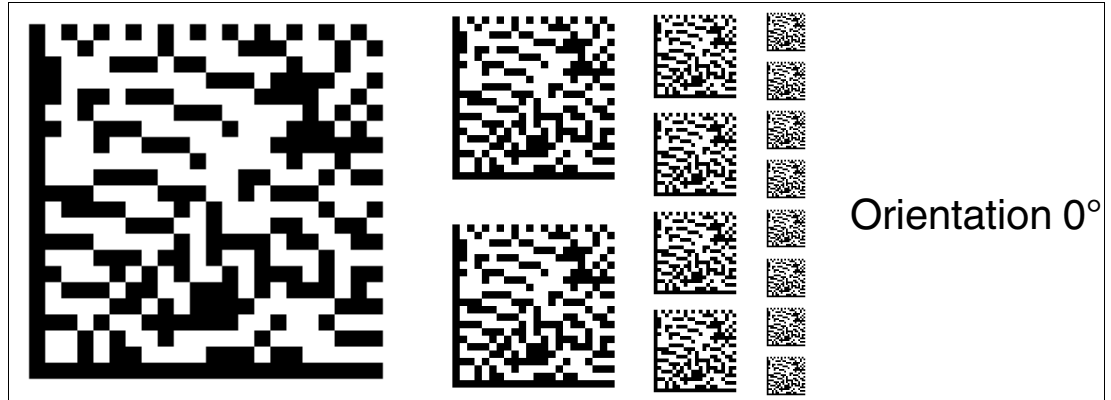

Figure 6.9 The code card assigns the orientation 0° to the read head.

Orientation 180°



Figure 6.10 The code card assigns the orientation 180° to the read head.

Orientation 0° and 180°

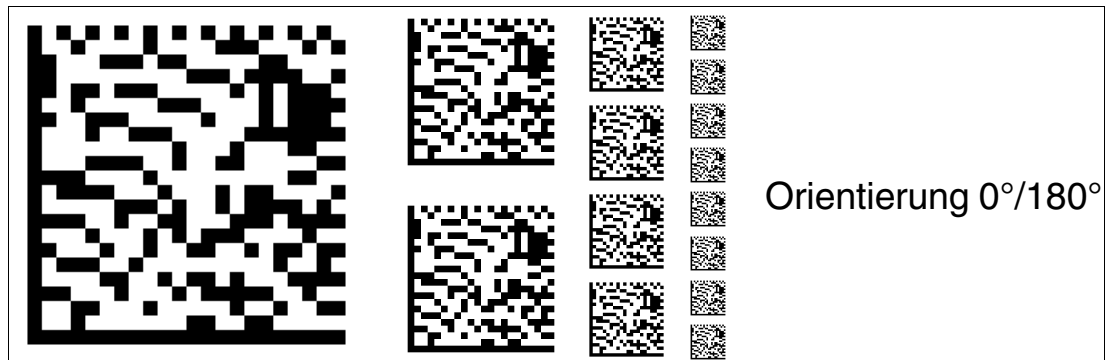

Figure 6.11 The code card assigns the orientation 0° and 180° to the read head. With this setting, the read head can read the Data Matrix code band in 0° and 180° orientation.

6.1.4 Code cards for setting the transfer rate

Parameterization allows you to assign various transfer rates to the reading head for communication via the interface. The following transfer rates are available:

- 38400 bit/s
- 57600 bit/s
- 76800 bit/s
- 115200 bit/s
- 230400 bit/s

Transfer rate: 38400 bit/s

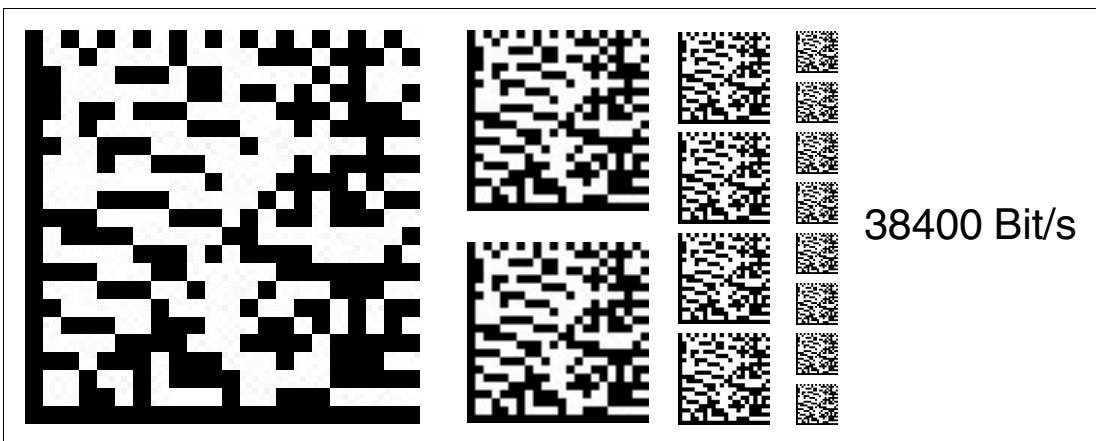

Figure 6.12 The transfer rate of the read head for communication via the interface is preset to 38400 bit/s.

Transfer rate: 57600 bit/s

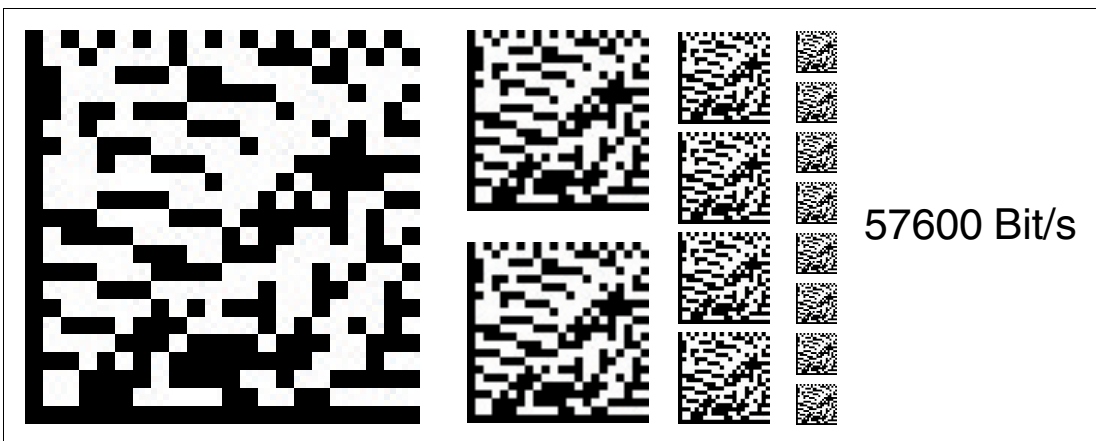

Figure 6.13 The transfer rate of the read head for communication via the interface is preset to 57600 bit/s.

Transfer rate: 76800 bit/s



Figure 6.14 The transfer rate of the read head for communication via the interface is preset to 76800 bit/s.

Transfer rate: 115200 bit/s

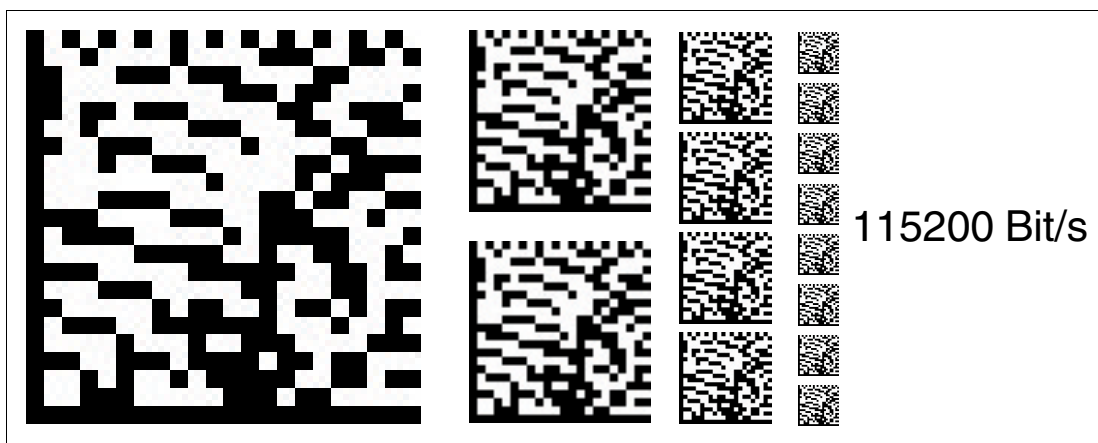

Figure 6.15 The transfer rate of the read head for communication via the interface is preset to 115200 bit/s.

Transfer rate: 230400 bit/s

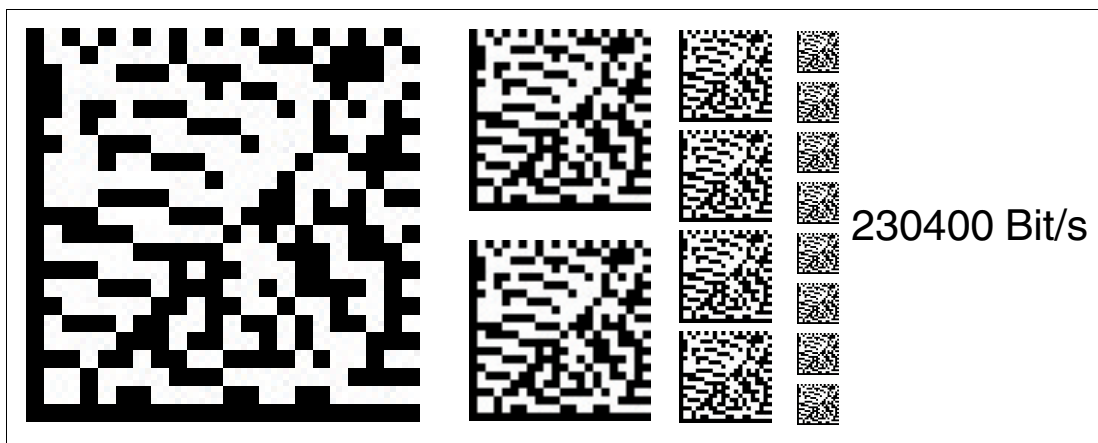

Figure 6.16 The transfer rate of the read head for communication via the interface is preset to 230400 bit/s.

6.1.5 Code Cards for Adjusting Input/Output 3

Parameterization enables you to assign various functions to input/output 3 on the read head. The following input/output functions are available:

- Input: none
- Output: Overspeed
- Output: Warning
- Output: Fault
- Output: Event
- Output: No position

Input 3: No Function

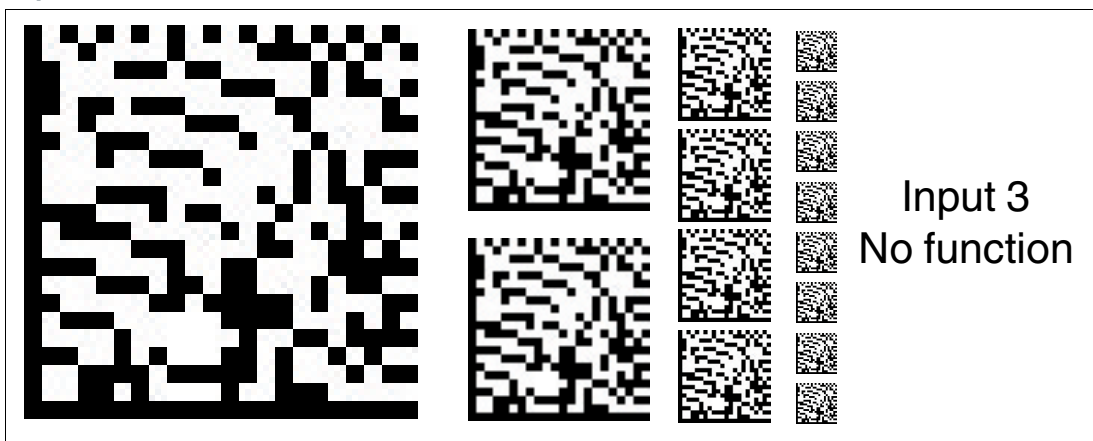

Figure 6.17 Input/output 3 is defined as an input but has no function.

Output 3: Overspeed

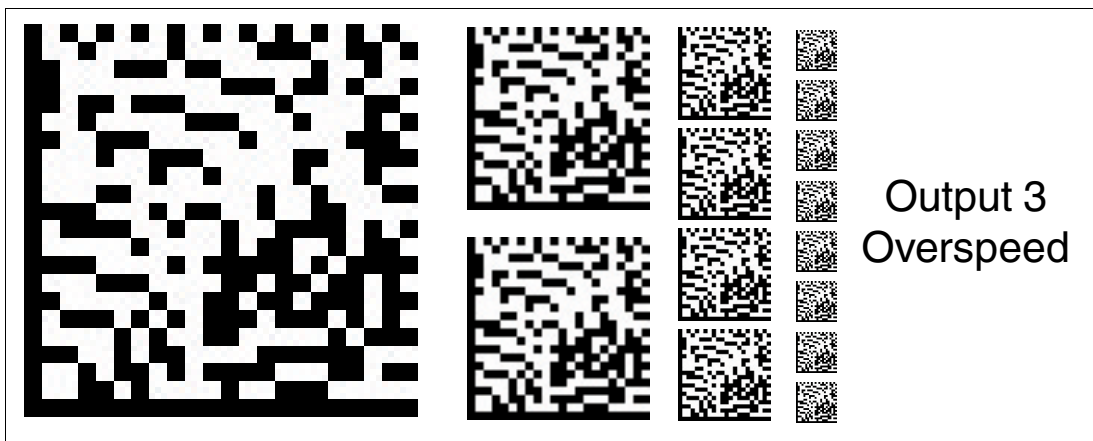

Figure 6.18 Input/output 3 is defined as an output. This output carries the potential $+U_B$ as long as the defined maximum speed is exceeded.

Output 3: Warning

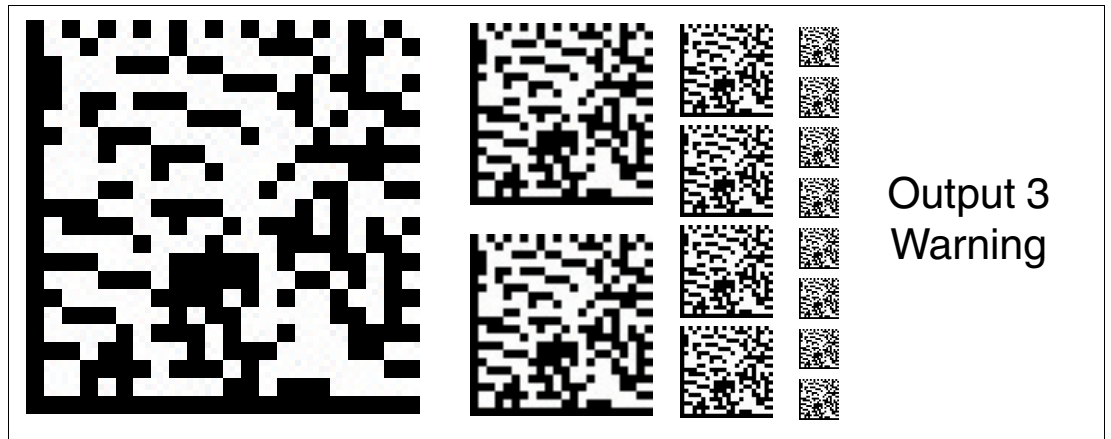

Figure 6.19 Input/output 3 is defined as an output. This output carries the potential $+U_B$ as long as a warning message is present in the read head.

Output 3: Fault

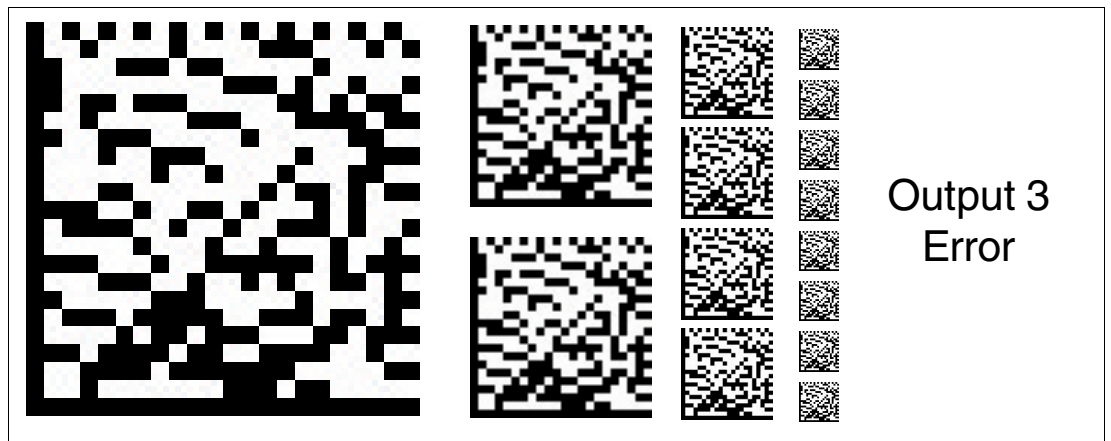

Figure 6.20 Input/output 3 is defined as an output. This output carries the potential $+U_B$ as long as an error message is present on the read head.

Output 3: Event

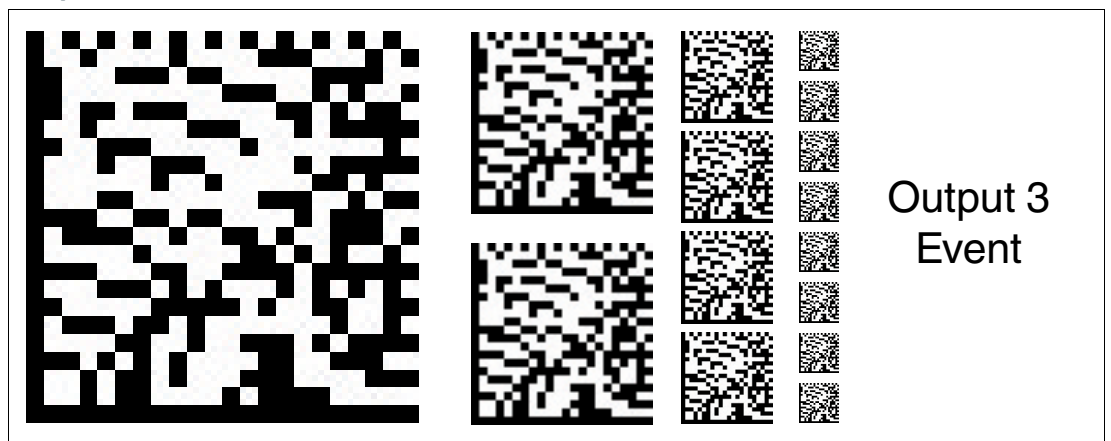

Figure 6.21 Input/output 3 is defined as an output. This output carries the potential $+U_B$ as long as an event marker is present in the read field of the read head.

Output 3: No position

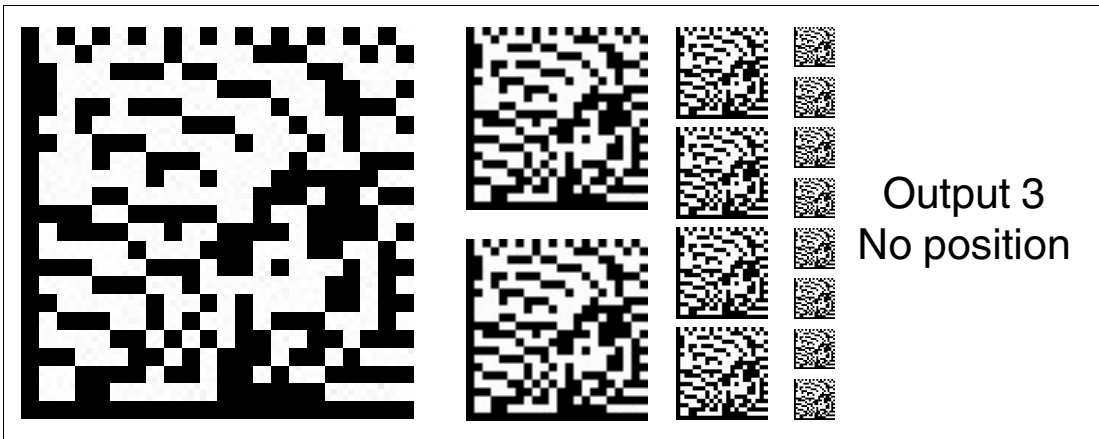

Figure 6.22 Input/output 3 is defined as an output. This output carries the potential $+U_B$ as long as the read head is not reading any position information.

Your automation, our passion.

Explosion Protection

- Intrinsic Safety Barriers
- Signal Conditioners
- FieldConnex® Fieldbus
- Remote I/O Systems
- Electrical Ex Equipment
- Purge and Pressurization
- Industrial HMI
- Mobile Computing and Communications
- HART Interface Solutions
- Surge Protection
- Wireless Solutions
- Level Measurement

Industrial Sensors

- Proximity Sensors
- Photoelectric Sensors
- Industrial Vision
- Ultrasonic Sensors
- Rotary Encoders
- Positioning Systems
- Inclination and Acceleration Sensors
- Fieldbus Modules
- AS-Interface
- Identification Systems
- Displays and Signal Processing
- Connectivity

Pepperl+Fuchs Quality

Download our latest policy here:

www.pepperl-fuchs.com/quality

