

Manual for  
WILSEN.sonic.level  
WS-UCC\*-F406-B15-B41\*

Manual



---

With regard to the supply of products, the current issue of the following document is applicable:  
The General Terms of Delivery for Products and Services of the Electrical Industry, published  
by the Central Association of the Electrical Industry (Zentralverband Elektrotechnik und Elek-  
troindustrie (ZVEI) e.V.) in its most recent version as well as the supplementary clause:  
"Expanded reservation of proprietorship"

**Worldwide**

Pepperl+Fuchs Group  
Lilienthalstr. 200  
68307 Mannheim  
Germany  
Phone: +49 621 776 - 0  
E-mail: [info@de.pepperl-fuchs.com](mailto:info@de.pepperl-fuchs.com)

**North American Headquarters**

Pepperl+Fuchs Inc.  
1600 Enterprise Parkway  
Twinsburg, Ohio 44087  
USA  
Phone: +1 330 425-3555  
E-mail: [sales@us.pepperl-fuchs.com](mailto:sales@us.pepperl-fuchs.com)

**Asia Headquarters**

Pepperl+Fuchs Pte. Ltd.  
P+F Building  
18 Ayer Rajah Crescent  
Singapore 139942  
Phone: +65 6779-9091  
E-mail: [sales@sg.pepperl-fuchs.com](mailto:sales@sg.pepperl-fuchs.com)  
<https://www.pepperl-fuchs.com>

---

<b>1</b>	<b>Introduction.....</b>	<b>4</b>
1.1	Content of this Document.....	4
1.2	Target Group, Personnel .....	4
1.3	Symbols Used .....	4
1.4	Intended Use .....	5
1.5	General Safety Notice.....	5
1.6	Declaration of Conformity.....	6
<b>2</b>	<b>System Description .....</b>	<b>7</b>
<b>3</b>	<b>Integration into a LoRa Network .....</b>	<b>8</b>
<b>4</b>	<b>Establishing a Connection to the Device .....</b>	<b>10</b>
<b>5</b>	<b>Mounting.....</b>	<b>14</b>
5.1	Installation Conditions .....	14
5.2	Mounting Instructions .....	14
<b>6</b>	<b>Measurement Data Acquisition and Data Transfer of the WILSEN.sonic.level..</b>	<b>17</b>
<b>7</b>	<b>Parameterization/Information with the WILSEN app.....</b>	<b>18</b>
7.1	Menu Structures .....	18
7.2	App Settings Menu .....	19
7.3	Ultrasonic Sensor Submenu.....	20
7.4	GPS Configuration Submenu .....	26
7.5	LoRaWAN Configuration Submenu.....	27
7.6	Device Configuration Submenu .....	31
7.7	Device Information Submenu .....	33
<b>8</b>	<b>Servicing.....</b>	<b>35</b>
<b>9</b>	<b>Replacing the Battery.....</b>	<b>36</b>
<b>10</b>	<b>Cleaning.....</b>	<b>39</b>
<b>11</b>	<b>Repair.....</b>	<b>40</b>
<b>12</b>	<b>Disposal.....</b>	<b>41</b>

# 1 Introduction

## 1.1 Content of this Document

This document contains information required to use the product in the relevant phases of the product life cycle. This may include information on the following:

- Product identification
- Delivery, transport, and storage
- Mounting and installation
- Commissioning and operation
- Maintenance and repair
- Troubleshooting
- Dismounting
- Disposal



---

### Note

For full information on the product, refer to the further documentation on the Internet at [www.pepperl-fuchs.com](http://www.pepperl-fuchs.com).

---

The documentation comprises the following parts:

- This document
- Datasheet

In addition, the documentation may comprise the following parts, if applicable:

- EU-type examination certificate
- EU declaration of conformity
- Attestation of conformity
- Certificates
- Control drawings
- Instruction manual
- Other documents

## 1.2 Target Group, Personnel

Responsibility for planning, assembly, commissioning, operation, maintenance, and dismantling lies with the plant operator.

Only appropriately trained and qualified personnel may carry out mounting, installation, commissioning, operation, maintenance, and dismantling of the product. The personnel must have read and understood the instruction manual and the further documentation.

Prior to using the product make yourself familiar with it. Read the document carefully.

### 1.3 Symbols Used

This document contains symbols for the identification of warning messages and of informative messages.

#### Warning Messages

You will find warning messages, whenever dangers may arise from your actions. It is mandatory that you observe these warning messages for your personal safety and in order to avoid property damage.

Depending on the risk level, the warning messages are displayed in descending order as follows:



---

#### **Danger!**

This symbol indicates an imminent danger.

Non-observance will result in personal injury or death.

---



---

#### **Warning!**

This symbol indicates a possible fault or danger.

Non-observance may cause personal injury or serious property damage.

---



---

#### **Caution!**

This symbol indicates a possible fault.

Non-observance could interrupt the device and any connected systems and plants, or result in their complete failure.

---

#### Informative Symbols



---

#### **Note**

This symbol brings important information to your attention.

---



---

#### **Action**

This symbol indicates a paragraph with instructions. You are prompted to perform an action or a sequence of actions.

## 1.4 Intended Use

The WILSEN.sonic.level wireless ultrasonic sensor is used to remotely monitor fill levels in containers, tanks, and silos. It is part of Pepperl+Fuchs' WILSEN (wireless sensor) IoT sensor product family, which wirelessly transmits data directly to the internet.

The fill level is measured at regular intervals and transmitted to the internet via a radio interface. The measurement and transmission frequency can be parameterized via a Bluetooth interface and by using an app for mobile end devices.

The wireless sensor also features a GPS geolocation function. Temperature and battery control functions are used to monitor the status of the sensor.

---

### Note

The device must not be used in explosion-hazardous areas.

---

Only use recommended original accessories.

## 1.5 General Safety Notice

Responsibility for planning, assembly, commissioning, operation, maintenance, and dismantling lies with the plant operator.

Installation and commissioning of all devices may be performed only by trained and qualified personnel.

It is dangerous for the user to make changes and/or repairs. Additionally, doing so voids the warranty and excludes the manufacturer from any liability. In the event of any serious errors, stop using the device. Secure the device against unintended operation. To have the device repaired, return it to your local Pepperl+Fuchs representative or your sales center.

---

### Warning!

Risk of fire due to improper use.

Damaged or defective lithium-ion batteries are a major fire hazard. Ensure that the battery is protected from mechanical damage, short circuits, and excessive heat load during servicing and while the wireless ultrasonic sensor is being operated. The permissible ambient temperatures from -25 °C to +70 °C and the permissible storage temperatures from -40 °C to +85 °C must always be observed. The device enclosure and ultrasonic sensor enclosure comply with flammability class V-0(AO) according to IEC 60695-11-10 and therefore must not be operated in areas with an automatic extinguishing system. Devices with damaged batteries must be removed immediately, taken out of operation, and stored safely in accordance with local fire prevention regulations.

---

### Warning!

Risk of injury if battery is defective!

This device uses a high-energy cell for voltage supply. This battery contains lithium and thionyl chloride. If these substances are released, the appropriate protective measures must be observed. Refer to the safety data sheet.

In case of leakage, contact with the skin or eyes may cause severe irritation and burns. Inhalation of electrolyte vapors may affect the upper respiratory tract and lungs.

---

### Note

The safety data sheet for lithium-thionyl chloride batteries can be found online at [www.pepperl-fuchs.com](http://www.pepperl-fuchs.com), on the product detail page for the respective wireless ultrasonic sensor WS-UCC\*-F406-B15-B41-\* under "Documents."

---



**Caution!**

Risk of unauthorized sensor access due to unprotected access data.

To use and operate the WILSEN.sonic.level wireless ultrasonic sensor safely, access data such as passwords and the application key must be protected. The plant operator is responsible for protecting this data; the operator must document the access data, protect it from unauthorized access, and keep it safe.

---



**Note**

**Disposal**

Electronic waste is dangerous. When disposing of the equipment, observe the current statutory requirements in the relevant country of use and local regulations.

---

**1.6**

**Declaration of Conformity**

This product was developed and manufactured in line with the applicable European standards and directives.

---



**Note**

A declaration of conformity can be requested from the manufacturer.

---

The product manufacturer, Pepperl+Fuchs Group, 68307 Mannheim, Germany, has a certified quality assurance system that conforms to ISO 9001.



## 2 System Description

The WILSEN.sonic.level wireless ultrasonic sensor is used to remotely monitor fill levels in containers, tanks, and silos. It is part of Pepperl+Fuchs' WILSEN (wireless sensor) IoT sensor product family, which wirelessly transmits data directly to the internet.

The fill level is measured at regular intervals and transmitted to the internet via a radio interface. The measurement and transmission frequency can be parameterized via a Bluetooth interface and by using an app for mobile end devices.

To transfer the measurement data, you must integrate the IoT sensors with LoRaWAN interface into a LoRaWAN network. This requires additional system components such as a LoRa gateway and LoRa network server (LNS).

The following figure illustrates the topology of integrating a WILSEN.sonic.level wireless ultrasonic sensor into a LoRaWAN network.

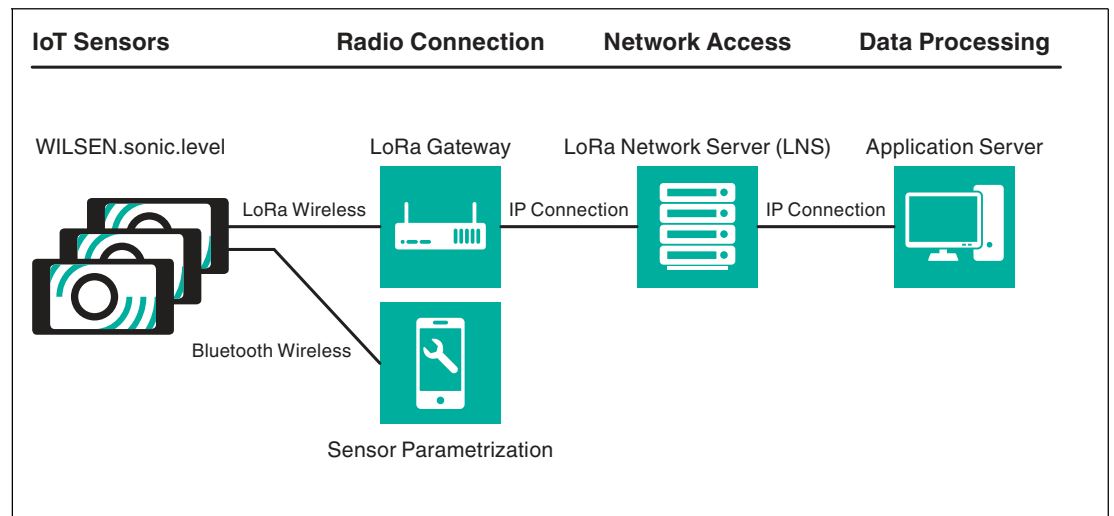

Figure 2.1



**Note**

You can find further information on the LoRaWAN standard at:  
<https://lora-alliance.org>



### 3 Integration into a LoRa Network

The WILSEN.sonic.level wireless ultrasonic sensor sends the cyclically transmitted measurement data in the standardized LoRaWAN protocol via a radio interface. To do this, the sensor must be logged into a corresponding LoRaWAN network. The sensor can log into a network once it has been registered with the LoRa network server.

The following figure illustrates the topology of integrating a WILSEN.sonic.level wireless ultrasonic sensor into a LoRaWAN network.

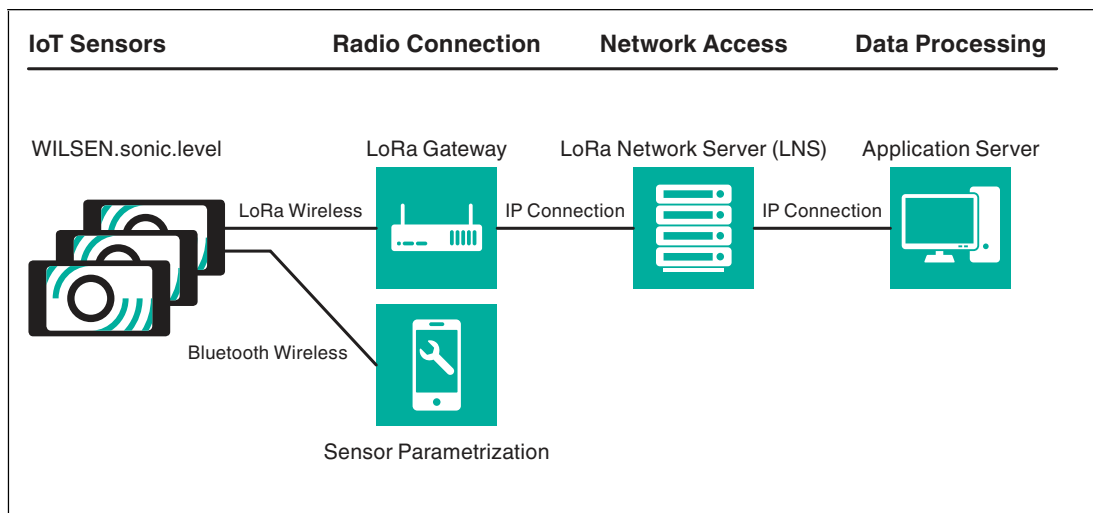

Figure 3.1

#### LoRa Wireless Connection

The measurement data collected by the sensor is transmitted to the LoRaWAN network at regular time intervals in the format of an encrypted hexadecimal value chain (payload). This payload is received by one or more gateways and translated into the internet protocol (IP format). The translated payload is transmitted from the gateway to the LoRa network server via a cable Ethernet line or a wireless connection.

#### LoRa Network Server and Application Server

The LoRa network server (LNS) filters the incoming data packets, assigns them to the corresponding sensors, and forwards them to an application server. The application server decrypts the data packets and saves the sensor data contained in them. The data can be retrieved and displayed from the application server memory at a later time by the processing software application of the data user.

#### Registering the Sensor with a LoRa Network Server

To register the WILSEN.sonic.level with a LoRa network server, a customer account with the corresponding software service is required. Services usually make their registration procedure available in dialog form. Familiarize yourself with the details of your network server.

#### Note

In a separate document, Pepperl+Fuchs describes the procedure for registering a WILSEN.sonic.level using the example of registering with "The Things Network (TTN)" community network.

You can download the document online from the product detail page for the respective WS-UCC\*-F406-B15-B41-\* wireless ultrasonic sensor at [www.pepperl-fuchs.com](http://www.pepperl-fuchs.com).

The objective of the registration procedure is to exchange software keys, which contain the unique device authentication and an encryption of the sensor data to be transmitted (measurement data).

## Device Authentication

When using LoRaWAN, the device is uniquely identified via the **Device EUI**. This is provided by the device manufacturer and transferred to the LoRa network server (LNS).

With the WILSEN.sonic.level, you will find this 16 digit number in hexadecimal format by connecting to the device using the WILSEN app. The "LoRaWAN Configuration" menu in the app displays the device-specific **Device EUI**. Alternatively, the Device EUI can also be found on the nameplate and the packaging label of the device.

To structure the system, some LNS services still use a 16 digit **Application EUI** as another identification feature.

For more information, familiarize yourself with the details in the description provided by your LNS provider. If an Application EUI is provided by the LNS or if you create one yourself, you must enter it in the **Application EUI** field in the WILSEN app (See chapter 7).

## Encryption of Telemetry Data

With LoRaWAN, sensor data is always transmitted from the sensor to the application server in an encrypted format. The AES128 standard is used for this end-to-end encryption.

WILSEN.sonic.level uses the 32 digit application key to encrypt the measurement data to be transmitted. Select the over-the-air activation (OTAA) registration procedure for your LoRa network server. Some network servers will then provide you with an Application Key. Alternatively, the Application Key provided by the sensor unit can be transferred to the intended LoRa environment.

An Application Key provided by a network server must then be transferred to the sensor using the WILSEN app. (See chapter 7.5).

Once the registration information has been exchanged between WILSEN.sonic.level and the LoRaWAN network server or application server, the data transfer can be started.

If the sensor is within the detection range of a LoRa gateway and is connected to this gateway, the sensor immediately starts to contact the LoRa network server.

See chapter 7 "Parameterization/Information with the WILSEN app" for setting the transmission intervals using the WILSEN app.

## Payload

The regularly measured sensor data is transmitted to the LoRa network server on the internet at adjustable transmission intervals. The structure of this usable data is referred to as a payload.

The payload of a transmission packet is a string of up to 51 bytes of hexadecimal numbers—the contents of which must be interpreted on the receiving side using a payload decoder. The structure of the payload for the WILSEN.sonic.level is described in an additional document regarding the payload.

LoRa network server providers make available various tools for decoding the payload on the receiving side. Some providers make it very easy to create such a decoder using a form template, e.g., in JavaScript. Other providers offer an input field for a finished piece of program code in JavaScript. Please familiarize yourself with the specific details of the payload decoder of your respective provider.

On its homepage, Pepperl+Fuchs provides a payload decoder for download in JavaScript format. You can open this script using a text editor and copy and paste it into the input field for the payload decoder of the LNS provider.

---

### Note



You can download the payload description and the payload decoder for your WILSEN.sonic.level online from the product detail page for the respective WS-UCC\*-F406-B15-B41-\* wireless ultrasonic sensor at [www.pepperl-fuchs.com](http://www.pepperl-fuchs.com). See the Documents and Software areas.

---

## 4 Establishing a Connection to the Device

### Prerequisites

A mobile device that meets the following prerequisites is required to connect and subsequently parameterize the device:

- Operating system Android version 5 or higher / iOS version 12.4 or higher
- Minimum Bluetooth version: 4.0 or higher (Bluetooth Low Energy must be supported)
- Bluetooth is enabled on the mobile device
- Location detection is enabled on the mobile device
- Mobile device has an internet connection
- Mobile device has an account set up on Google Play or the Apple App Store



1. Go to the App Store on your mobile device and search for the Pepperl+Fuchs "WILSEN" app or scan the following QR code.



Figure 4.1 WILSEN in Google Play



Figure 4.2 WILSEN in the Apple App Store

2. Follow the instructions to download and install the app.



#### Note

On the mobile device, make sure that Bluetooth and location detection (GPS) are switched on and that the associated app permissions have not been restricted by the user.

3. Open the app by tapping the app icon.

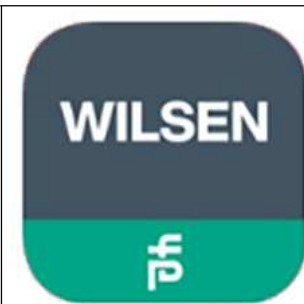

Figure 4.3

↳ The WILSEN app Device Discovery will appear. Available devices within range will be displayed after a short time.

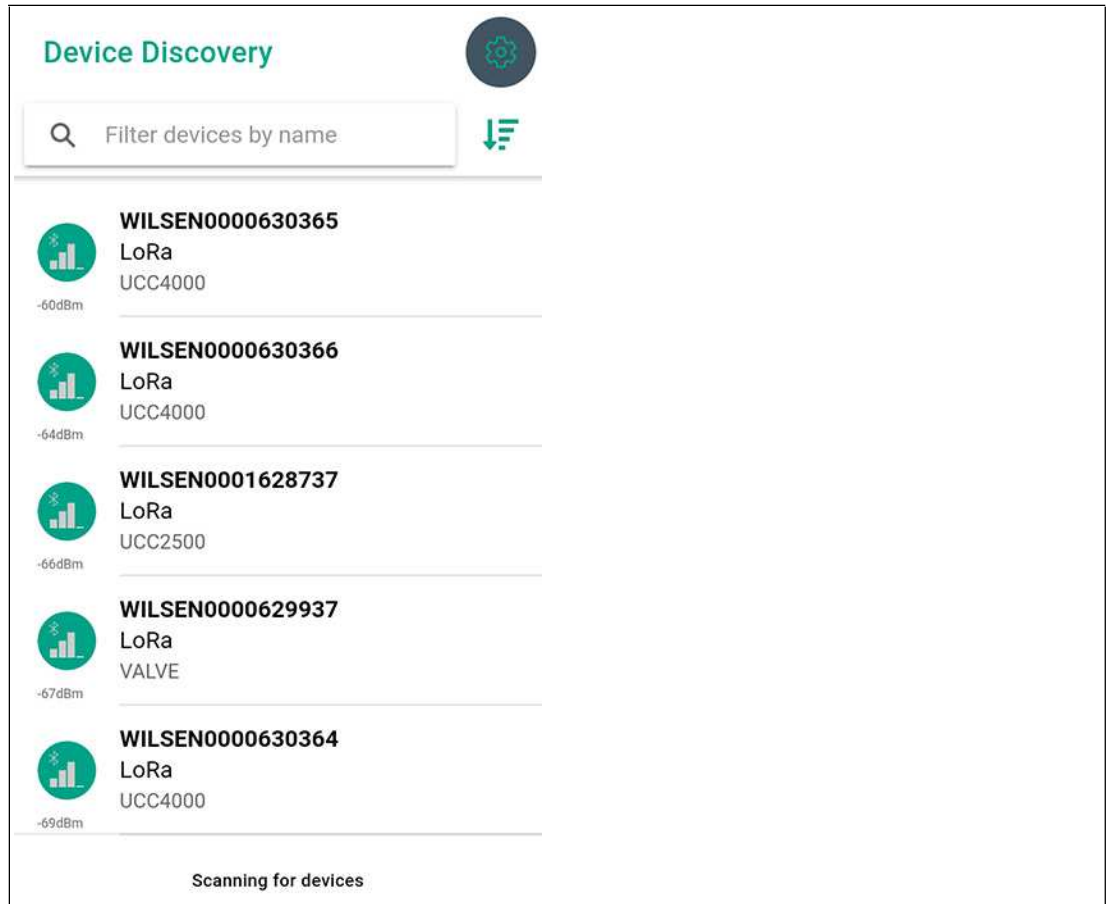

Figure 4.4



**Tip**

By entering the desired device name or part of it, you can reduce the number of devices displayed in the list in accordance with the search.

The "Sort" icon to the right of the input field allows you to sort the displayed devices according to various criteria. However, you can also use this to completely disable a specific sort order. In this case, newly found devices are simply added to the end of the list.

4. Tap on the desired device to connect it to the app.



**Tip**

When using the iOS version of the app, the system will issue a pairing request during the connection setup process and this must be confirmed by the user.

5. Enter the default password 00000000 within 30 seconds when commissioning a new device or enter the valid password for a device that is already known and confirm by pressing OK.

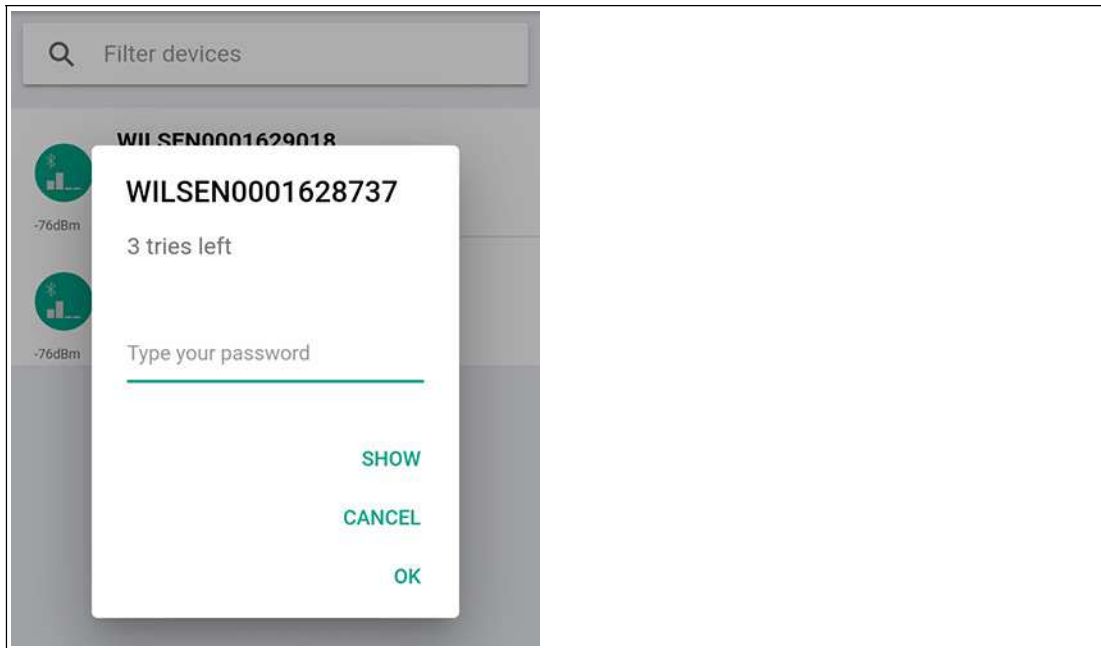

Figure 4.5

↳ The app will switch to the **Sensor Status & Configuration** menu, which displays current sensor values and provides access to sensor settings.

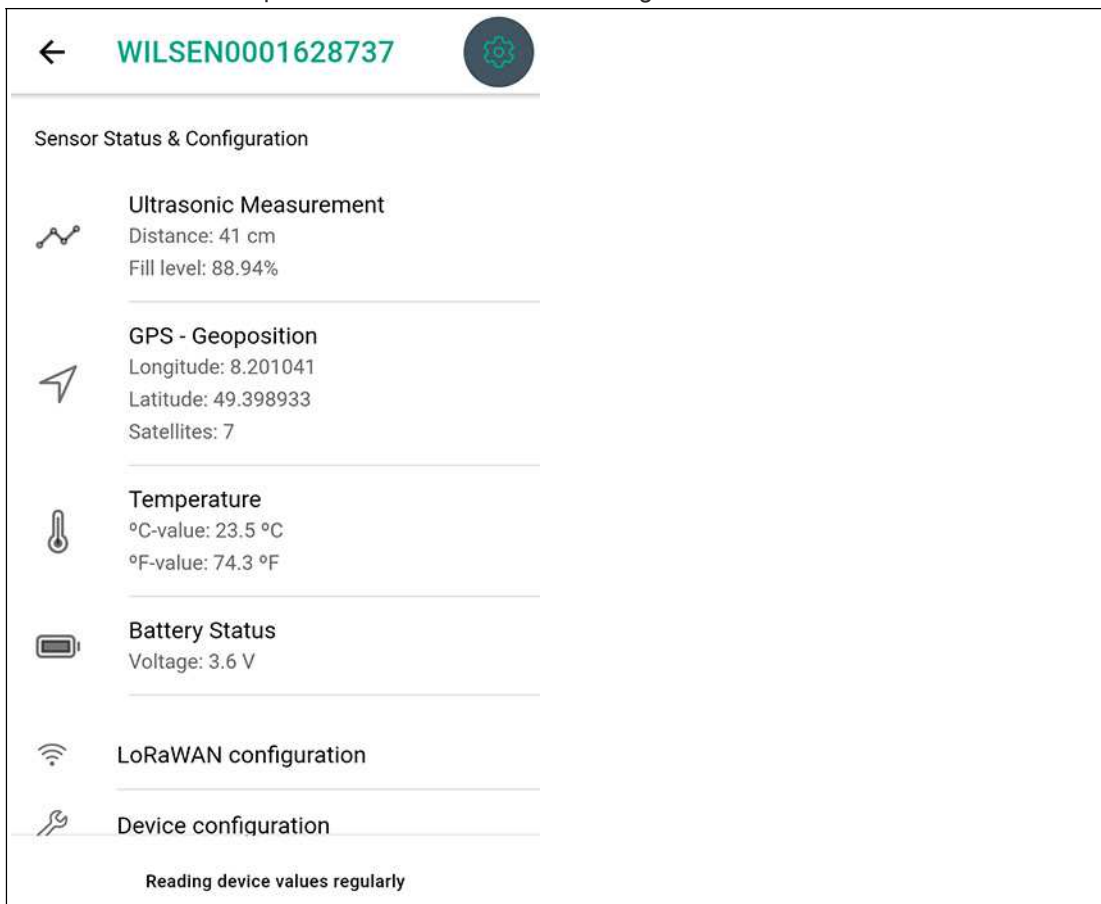

Figure 4.6



---

**Caution!**

**High Power Consumption during Bluetooth Connection**

To ensure the longest possible battery life, keep the connection time between the mobile device and the wireless ultrasonic sensor via Bluetooth and the app as short as possible.

Make sure that you properly disconnect the Bluetooth connection after the parameterization and commissioning have been completed. This prevents unwanted, high energy consumption.

---



---

**Note**

**Temporary Block after Three Incorrect Password Entries**

If the password is incorrectly entered three times in a row, the device is blocked from reconnecting via Bluetooth for a specific period of time.

This is indicated by the "Blocked" sign in the device list. It also contains a note indicating when the device will be accessible via Bluetooth again. Once the field is re-enabled, if an incorrect password continues to be entered multiple times the blocking period is extended by an increasingly larger timeframe after every three attempts.

---

## 5 Mounting

### 5.1 Installation Conditions

To ensure proper functioning, you must observe the following installation conditions when mounting the wireless ultrasonic sensor in a container, tank, or silo:

- Installing the wireless ultrasonic sensor in shielded environments made of metal or other conductive components usually has a significant effect on the wireless connection and wireless range. These effects must be taken into account accordingly in such installation situations.
- The ultrasonic transducer must be aligned in the direction of the filling material to be measured.
- There must be no interfering elements in the sensing range of the ultrasonic sensor. Depending on the contour, the adjustable sensor configuration may be used to exclude interfering struts in the container. For more information, contact the application specialists at Pepperl+Fuchs.

## 5.2 Mounting Instructions

The wireless ultrasonic sensor is delivered pre-mounted on a mounting base for easy and quick mounting in a container, tank, silo, etc. The mounting base enables various mounting points.

The following drawing shows the dimensions and mounting points of the wireless ultrasonic sensor versions.

### WS-UCC2500-F406-B15-B\*

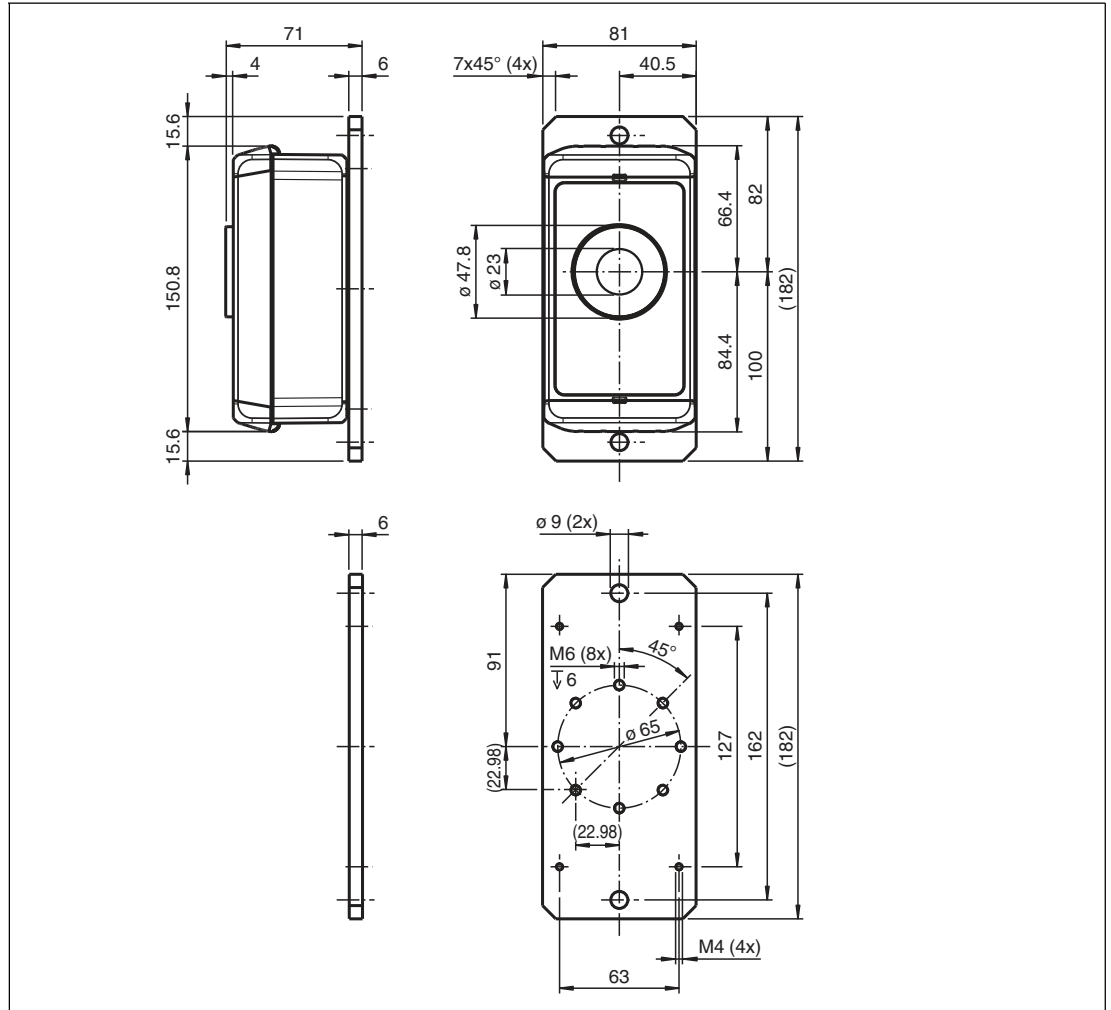

Figure 5.1



## WS-UCC4000-F406-B15-B\*

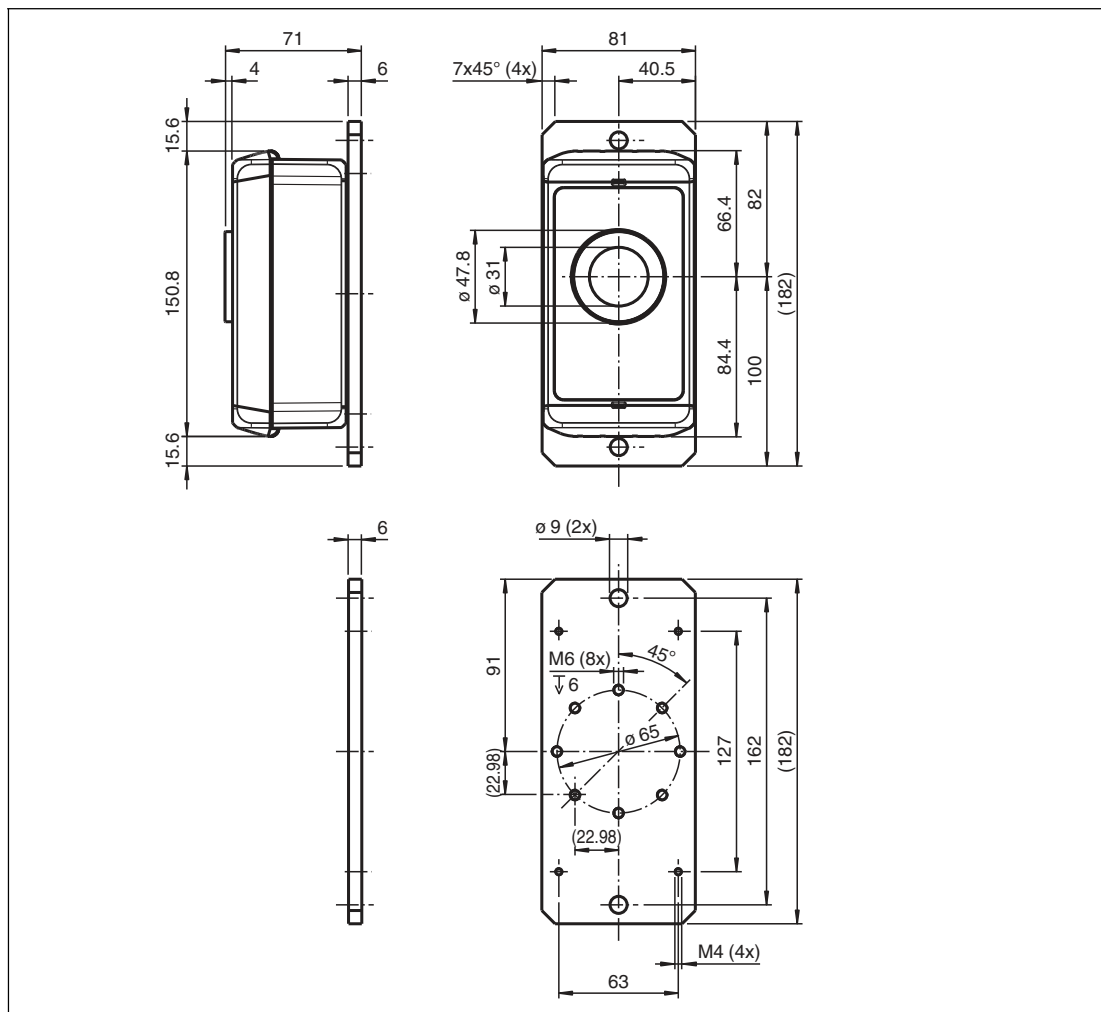

Figure 5.2

You can attach the mounting base to an installation location via the following points:

- Via the front sides using two 9 mm thru-holes with M8 screws and washers.
- Via the underside of the mounting base using the eight M6 threaded holes with a maximum screw-in depth of 7 mm and a tightening torque of  $\leq 1$  Nm.

## 6 Measurement Data Acquisition and Data Transfer of the WILSEN.sonic.level

The figure below illustrates the sequence of measurement data acquisition and data evaluation of the WILSEN.sonic.level in conjunction with the triggers that trigger them.

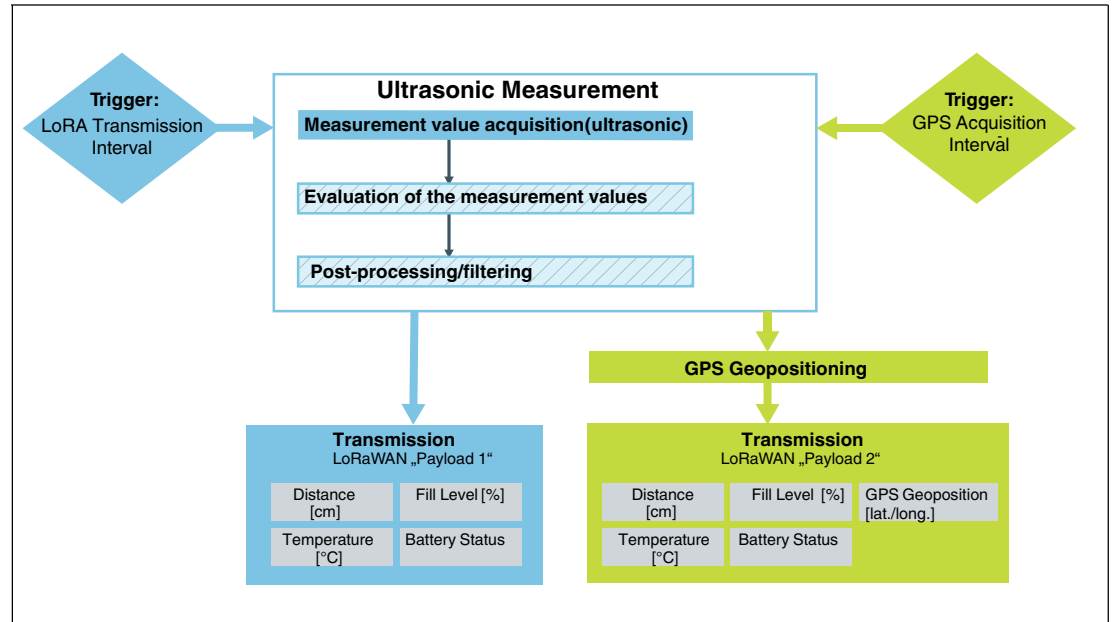

Figure 6.1 Ablaufdiagramm Messwerterfassung und Messwertauswertung

### Measurement Sequence

The ultrasonic measurement always consists of the actual measured value acquisition by sending out an ultrasound package and measuring the echo delay time to detect the distance to the object in the sensing range and a corresponding fill level.

Optionally, you can set a measurement sequence instead of a single measurement, i.e., a sequence of several individual measurements at defined time intervals. These measurements are then evaluated, e.g., on the basis of averaging and optionally further parameters, and calculated to provide a result.

Alternatively or in addition, the collected data can optionally be filtered using post-processing filters. This can be to further stabilize or optimize the measured value output for a specific application.

### Data Transfer

The ultrasound measurement sequence described above, with any optionally selected components, is triggered by the expiration of a set "LoRa transmission interval" (see chapter 7.5).

The values determined from the ultrasonic measurement (distance in cm and fill level in %) are then transferred alongside more information with the "Payload 1."

Alternatively or in addition, the same set ultrasonic measurement sequence is triggered by the expiration of the "GPS acquisition interval" (see chapter 7.4). In this case, the GPS position is also determined.

The values determined from the ultrasonic measurement (distance in cm and fill level in %) are then transferred alongside the acquired GPS position and more information with the "Payload 2."

## 7 Parameterization/Information with the WILSEN app

### 7.1 Menu Structures

The **Sensor Status & Configuration** menu is the central overview page for further navigation once the user has been successfully authenticated and Bluetooth has been connected.

The menu displays current device information and contains further submenus that allow parameterization of the device.

The app has the following structure and functions:

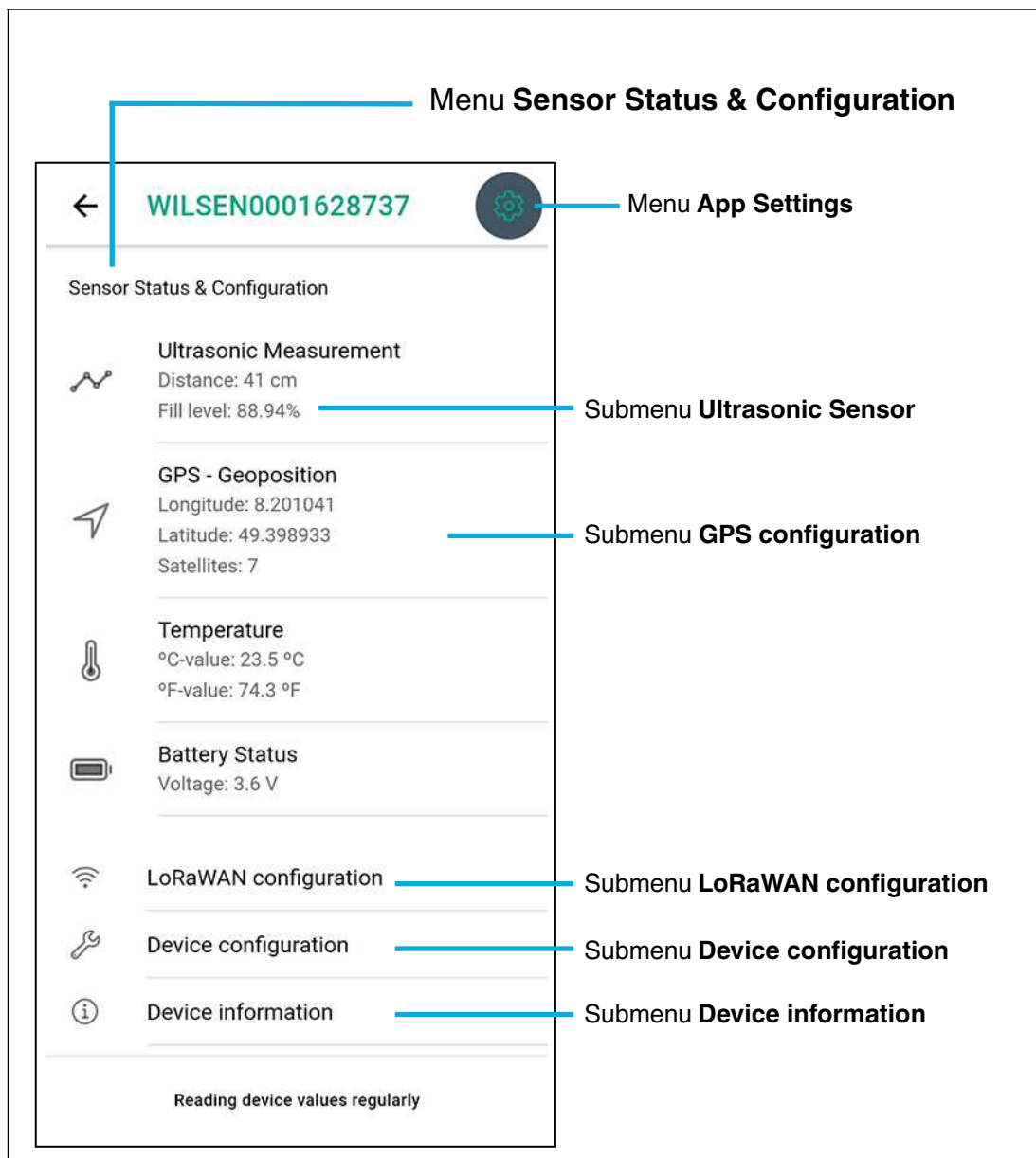

Figure 7.1

Menu/ submenu	Task/content
Sensor Status & Configuration	Main menu with submenus and displays for the device
App settings	Changing the language and information about the app version used
Ultrasonic Sensor	Setting the parameters for the ultrasonic measurement, such as the sound beam width, limits for fill-level determination, and additional settings in expert mode
GPS Configuration	Setting the parameters for GPS position determination and transmission frequency
LoRaWAN Configuration	Setting the LoRaWAN-specific parameters and the transmission frequency
Device Configuration	Setting the displayed device name, changing the device password, various reset options, and deactivating the Bluetooth interface
Device Information	Information about the device (device data and counter readings) and the option to update the firmware

Table 7.1

## 7.2 App Settings Menu

In the **App Settings** menu, you can select the language and color scheme used in the app. In addition, this menu shows legal notices along with the version number of the app installed on your device.

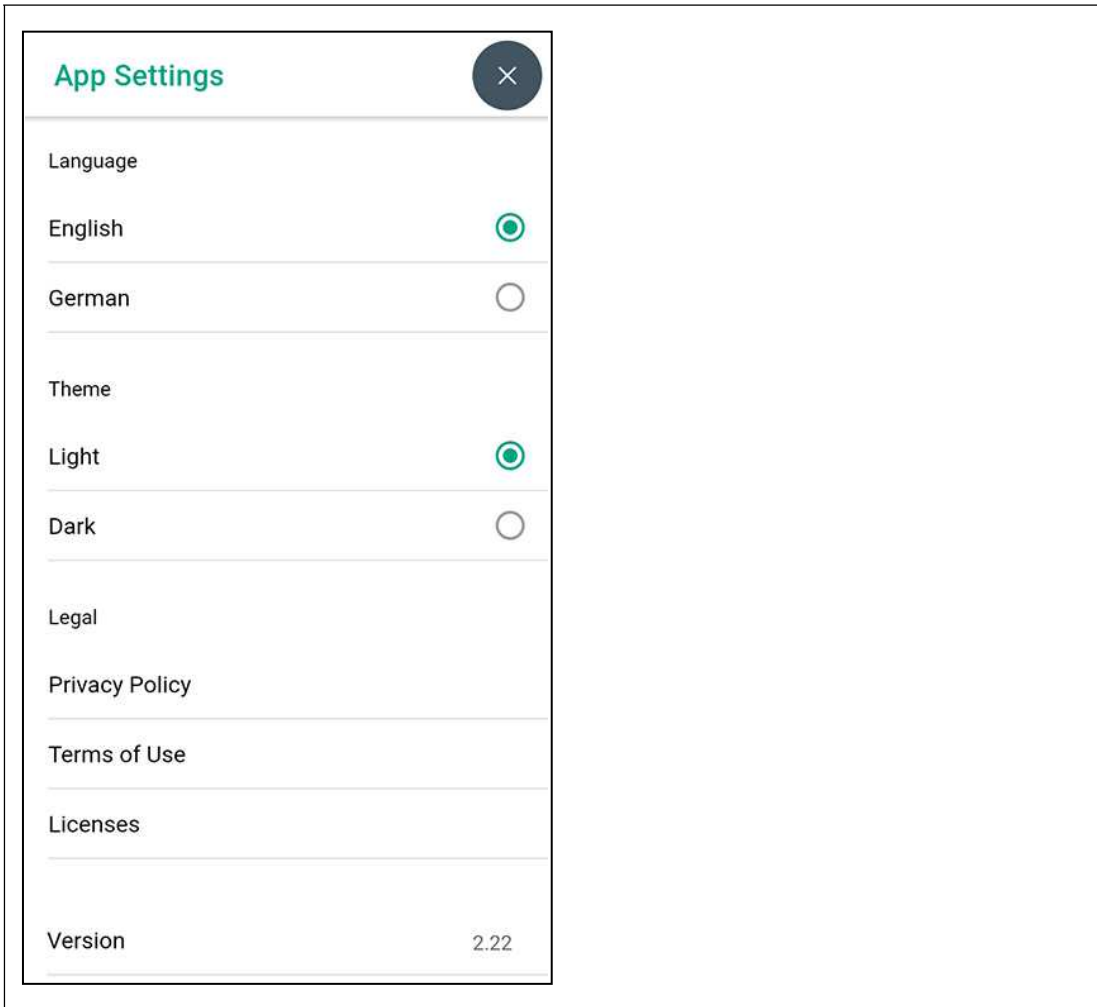

Figure 7.2

### 7.3 Ultrasonic Sensor Submenu

In the **Ultrasonic Sensor** submenu, you can set parameters for ultrasonic distance measurement.

Depending on the application, a simple normal mode and an expert mode are available.

#### Normal Mode

In normal mode, only the most important parameters are displayed in a reduced view.

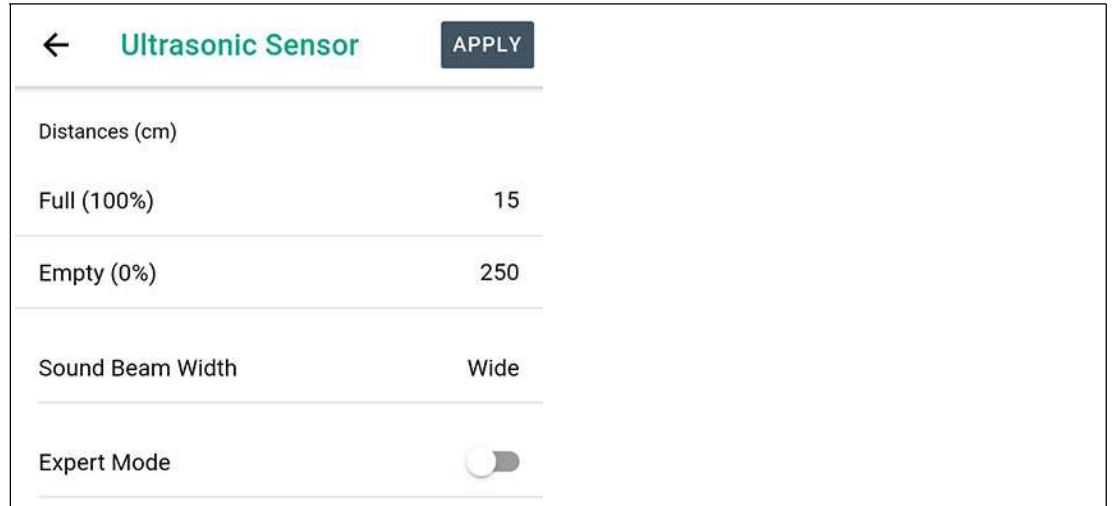

Figure 7.3

## Expert Mode

For more detailed settings, you can set expert mode.

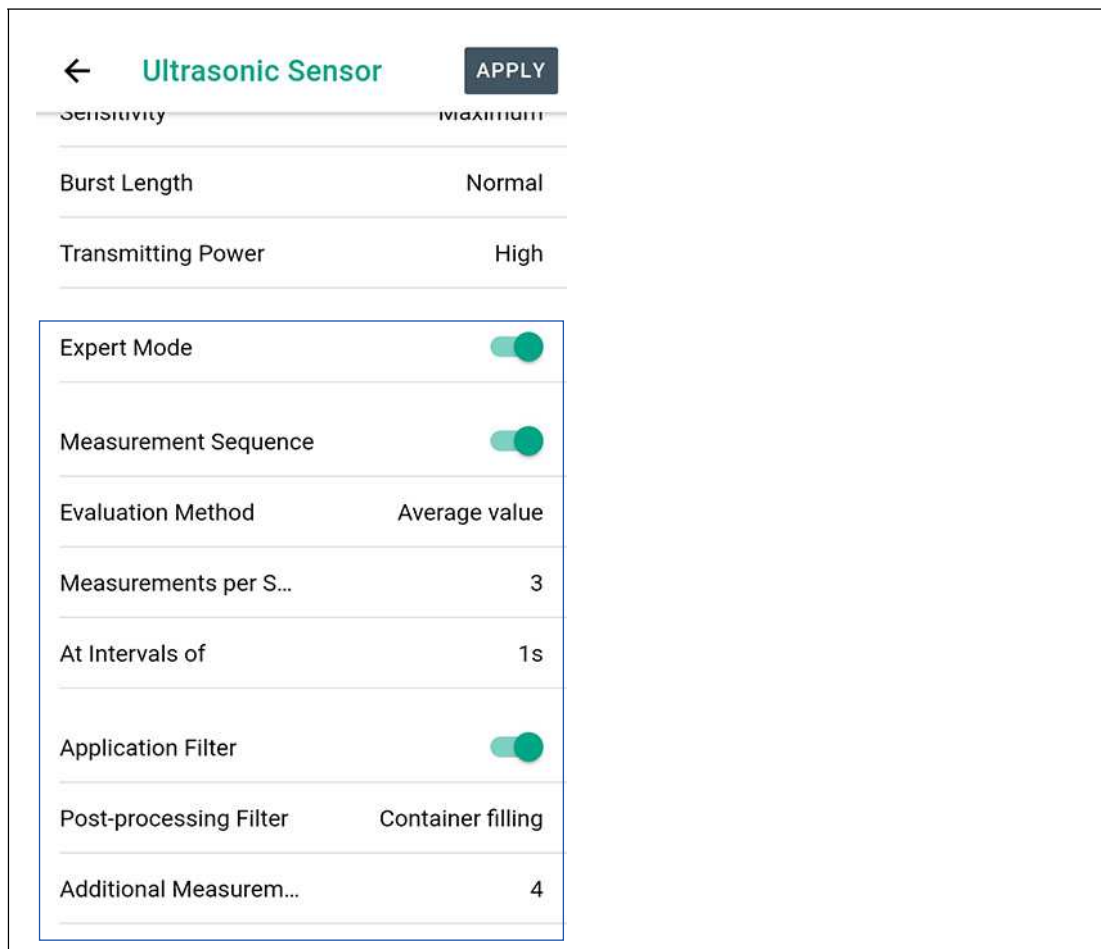

Figure 7.4

## Adjustable Parameters

### Distance values (cm) with Full (100 %)/Empty (0 %)

When these two values are set, the fill level of your container is displayed in the form of a corresponding percentage value. You must specify the appropriate distance values in cm.

### Beam Width

This parameter allows you to adjust the sound beam width of the ultrasonic sensor.

By default, you can choose between the following sound beam widths:

- Wide
- Medium
- Small
- User defined

Adjusting the sound beam width may be necessary in some cases. For example, if in the application objects can be detected in the boundary area of the sound beam, this may lead to incorrect data. Note that using a reduced sound beam with materials that do not reflect sound well can result in the fill level no longer being measured reliably over the complete sensing range specified in the datasheet.

**Note**

Detailed information on the three default sound beams of your sensor can be found in the corresponding datasheet in the "Characteristic Curve" section.

You can download the datasheet online from the product detail page for the relevant WS-UCC\*-F406-B15-B41-\* wireless ultrasonic sensor at [www.pepperl-fuchs.com](http://www.pepperl-fuchs.com).

← Ultrasonic Sensor		APPLY
Distances (cm)		
Full (100%)		15
Empty (0%)		250
Sound Beam Width		User-defined
Sensitivity		Maximum
Burst Length		Normal
Transmitting Power		High
Expert Mode		<input type="checkbox"/>

Figure 7.5

If none of the pre-selectable sound beam widths are suitable for your application, you can customize the sound beam. In this case, you must select the "User-defined" option in the "Sound Beam Width" parameter. The following three parameters appear, which allow for a more specific adjustment of the sound beam.

- Sensitivity
- Burst Length
- Transmitting Power

**Caution!**

Improper user-defined settings may result in malfunctions!

Improper setting of the Sensitivity, Burst Length, and Transmitting Power parameters may cause the sensor to stop functioning in the application. Specific properties of the sensor such as detection range, dead band, object detection reliability, etc. can change significantly.

We strongly recommend that these parameters only be set after consulting our application specialists.



### Sensitivity

This parameter sets the sensitivity of the ultrasonic amplifier.

You may select from the following six adjustment options:

- Maximum
- Very High
- High
- Medium
- Low
- Minimum

The resulting sound beam geometry, including possible influence on the dead band and detection range, depends on the settings of the "Sensitivity", "Transmitting Power", and "Burst Length" parameters. These three parameters together define the shape of the sound beam.

---

#### Note

Note that the "Maximum" setting results in a wider sound beam and the "Minimum" setting results in a very narrow sound beam.

Take into consideration that if the Sensitivity is not set to "Maximum," the sensing range of the ultrasonic sensor is reduced. Depending also on the reflection properties of the object to be detected, the nominal range of the ultrasonic sensor may not be reached.

We therefore recommend that the "Sensitivity" parameter only be set after consulting our application specialists.

---

### Burst Length

This parameter determines the length of the ultrasonic pulse emitted.

You may select from the following adjustment options:

- Normal
- Short
- Very short

By shortening the burst length, the dead band of the ultrasonic sensor can be shortened. However, this automatically reduces the sensing range of the ultrasonic sensor significantly and the nominal range is no longer reached.

The amplitude of the pulse is not affected by this parameter (see "Transmitting Power" parameter). Nevertheless, the effect of a change in the burst length is directly related to the "Transmitting Power" parameter. Both determine together how much and how long the ultrasonic transducer is excited and what acoustic energy the resulting sound package ultimately has. This results in the necessary dead band and also the maximum detection range of the ultrasonic sensor.

The resulting sound beam geometry, including possible influence on the dead band and detection range, depends on the settings of the "Sensitivity", "Transmitting Power", and "Burst Length" parameters. These three parameters together define the shape of the sound beam.

---

#### Note

Note that if the burst length is not set to "Normal," the sensing range of the sensor is drastically reduced.

We recommend that you only set this parameter after consulting our application specialists.

---



### Transmitting Power

Selecting one of the available options sets the amplitude of the emitted ultrasonic pulse.

You may select from the following adjustment options:

- High
- Medium
- Low

By reducing the transmitting power, you can shorten the dead band of the sensor. However, this automatically reduces the sensing range of the sensor significantly and the nominal range is no longer reached.

The burst length is not affected by this parameter. Nevertheless, the effect of a change in the transmitting power is directly related to the "Burst Length" parameter. Both determine together how much and how long the ultrasonic transducer is excited and what acoustic energy the resulting sound package ultimately has. This in turn results in the necessary dead band and also the maximum detection range of the sensor.

The resulting sound beam geometry, including possible influence on the dead band and detection range, depends on the settings of the "Sensitivity", "Transmitting Power", and "Burst Length" parameters. These three parameters together define the shape of the sound beam.



---

### Note

Note that if the transmitting power is not set to "High," the sensing range of the sensor is drastically reduced.

We recommend that you only set this parameter after consulting our application specialists.

---

### Expert Mode

Activation of expert mode enables further adjustment options of the ultrasonic sensor.

This includes the optional execution of a measurement sequence including the corresponding evaluation instead of the execution of only one single measurement.

Another function is optional post-processing of the measured value by appropriate filters.

### Measurement Sequence

Enabling this parameter allows you to perform a sequence of multiple ultrasonic distance measurements at defined time intervals instead of the normal single measurement and to smooth the data recorded in this way using an evaluation method.

By enabling this parameter in the app, the following three additional parameters are displayed:

- Evaluation Method
- Measurements per Seq
- At Intervals of

### Evaluation Method

This parameter allows you to define the processing method for the data recorded in the measurement sequence. Currently, the only available option is "Average Value." The outliers of the data recorded in the measurement sequence are first determined and excluded from further processing. The arithmetic average is then calculated using the remaining measurement data.

The number of outliers N depends on the number of measurements per sequence M. The following assignment applies.

M	N
1	0
2	0
3	1
4	1
5	2
6	2
7	3
8	3
9	4
10	4

Table 7.2

### Measurements per Seq. & At Intervals of

These two parameters allow you to define the number of measurements that make up the measurement sequence and the time interval at which they are performed.

#### Note

Note that the total time required to execute the measurement sequence may consist of up to several minutes, depending on the setting selected.

In extreme cases, for ten measurements at intervals of one min., it will take ten minutes until the next new measured value is available and can be transmitted.

#### Note

To ensure the longest possible service life of the built-in battery, activate a measurement sequence instead of an individual measurement only if so required in your application to obtain stable data. Keep the number of "Measurements per Sequence" as low as necessary. By contrast, the parameter "At Intervals of," has no effect on the energy consumption required for the execution of a measurement sequence.

### Application Filter

Enabling this parameter allows the new measured value determined from the individual measurement / measurement sequence to be processed or further smoothed by means of a filter before being transferred. Depending on the application, this may improve the stability of the data even further.

### Post-processing Filter

Depending on the selected filter, the measured value taken from the measurement sequence or recorded as an individual measurement is considered and evaluated in combination with historical data.

Currently, only the "Container filling" option is available as a post-processing filter.

The "Container filling" filter is intended for sensor applications in collection containers (old clothes, recycling, raw materials, etc.). In these applications, a container is continuously filled with content for a prolonged period of time. When a certain fill level is reached, the container is emptied.

The container filling filter always remembers the last reached maximum value of the percentage fill level during the current filling phase. If the new measured value is below this value, the last maximum value is still transmitted. If the new measured value is higher than the last maximum value, the maximum value is adjusted and the new maximum value of the percentage fill level is transmitted.

If the percentage fill level is abruptly reduced by more than 50 %, the filter assesses this to be the emptying process of the container. It adjusts the stored maximum value to the newly acquired lower level.

If the container is emptied at a fill level of less than 50 %, the filter likewise assesses a subsequently measured fill level value in the range of 0 –3 % as an "emptied container." The filter likewise adjusts the stored maximum value to the newly acquired lower level.



---

**Note**

This filter only affects the percentage fill level value, not the distance value in cm. The distance value always corresponds to the last determined distance value even if the container filling filter is enabled.

---

**Additional Measurements**

The application filter can be supplied with additional intermediate values by additional measurements / measurement sequences. Depending on the application, this may result in an even more stable or better smoothed fill level value.

The number of additionally set measurements / measurement sequences is carried out by the sensor, evenly distributed over time, within the set LoRa transmission interval.

For example:

- set LoRa transmission interval = six hours
- additional measurements = five

A measurement / measurement sequence is carried out every hour. Every six hours, the measured value determined within this six hour interval and evaluated via the filter is transmitted via LoRaWAN.



---

**Note**

The additional data is only collected and fed into the filter, but is not transferred individually.

---

**"Apply" Button**

Any changes made to parameters are only transferred to the sensor once the "Apply" button has been pressed; they are then saved to the sensor permanently.

## 7.4 GPS Configuration Submenu

In this submenu, you can activate the GPS function of the sensor and set the position determination frequency and transmission frequency.

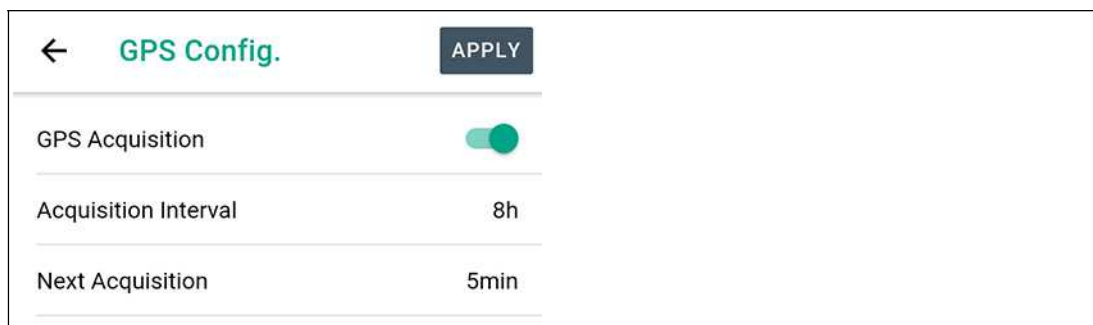

Figure 7.6

### GPS Acquisition

This switch activates the GPS function of the sensor. The two parameters "Acquisition Interval" and "Next Acquisition" then appear in the app.

### Acquisition Interval

The acquisition interval determines the frequency of the GPS position determination. At each of these points in time, an ultrasonic distance measurement or distance measurement sequence is performed in parallel with the position detection according to the settings in the ultrasonic sensor. The data collected in this way is then transferred together in a longer payload (see the "Payload Description" extra document, "Payload 2" section).

### Note

The collection of GPS data requires relatively high power consumption. To ensure the longest possible battery life, select a GPS acquisition interval appropriate for your application. However, avoid "unnecessarily frequent" detection.

### Note

The "GPS acquisition interval" operates independently of any "LoRa transmission interval" activated in parallel in the sensor (see chapter "LoRaWAN Configuration"). Each interval includes the corresponding specific payload, which is transmitted when the interval expires.

You can download the payload description and the payload decoder for your WILSEN.sonic.level online from the product detail page for the respective WS-UCC\*-F406-B15-B41-\* wireless ultrasonic sensor at [www.pepperl-fuchs.com](http://www.pepperl-fuchs.com). See the Documents and Software areas.

### Next Acquisition

This parameter is used to define when the next GPS acquisition and therefore also when the next transmission of the relevant payload is to take place. In this way, acquisitions and transmissions can also be defined by multiple wireless ultrasonic sensors in the particular application at specific times of the day.

### "Apply" Button

Any changes made to parameters are only transferred to the sensor once the "Apply" button has been pressed; they are then saved to the sensor permanently.

### Note

An initial or newly initiated acquisition of the GPS position will only take place after the time set in the "Next Acquisition" parameter has elapsed. Therefore, when you tap the "Apply" button, a corresponding countdown timer is displayed at the bottom of the GPS configuration menu. After the sensor has been detected for the first time, this countdown timer in the app will disappear.

## 7.5 LoRaWAN Configuration Submenu

The **LoRaWAN configuration** submenu is used to set the wireless connection parameters specific to LoRaWAN and to set the transmission frequency.

← LoRaWAN Config. <span>APPLY</span>	
Device EUI	9C:65:F9:FF:FE:45:66:8C
Application EUI	00:00:00:00:00:00:00:0 1
Application Key	E0:85:88:AB:24:99:40: 64:B5:16:46:DF:8F:5F: 5A:B0
Message type	Unconfirmed
Number of transmiss...	1
Spreading Factor	Automatic (ADR)
Data Transmission	<input checked="" type="checkbox"/>
Transmission Interval	24h
Next Transmission	5min

Figure 7.7

### Device EUI

The "Device EUI" is a device-specific identifier that identifies the device in the LoRa network. It is similar to the MAC ID of a node in a computer network.

The Device EUI is assigned to every device as a globally unique number according to IEEE rules. For this reason, it is not possible to change the Device EUI of your sensor.

### Application EUI / Join EUI

Application EUI/Join EUI is an identifier optionally assigned by the LoRa network server (LNS) or by you for the relevant application.

The Application EUI is preset with a uniform value and is identical for each sensor on delivery. This value can be used to establish a connection to a LoRa network. However, it is recommended that this value be adjusted to suit the particular LoRa environment when the sensor is commissioned.

### Application Key

The Application Key is used to encrypt the sensor measurement data before it is transmitted.

A random number is assigned at the factory as the Application Key and this is unique for each sensor unit. This default value only needs to be changed if the LoRa network provider or an existing LoRa environment defines a specific value for the Application Key. If it is not defined in this way, the Application Key provided by the sensor unit can be transferred to the intended LoRa environment.

## Message type

LoRaWAN offers two possible message types for the transmission of a device payload:

- "Unconfirmed" transmission:  
When you select the message type "Unconfirmed," the sensor sends its message to the gateway according to the set "Number of Transmissions" (see following parameter). However, it does not expect a receipt confirmation from the gateway.
- "Confirmed" transmission:  
When you select the message type "Confirmed," the sensor sends its message to the gateway and expects a receipt confirmation. If this is not received within a specified time frame, the sensor sends its message to the gateway a maximum of two more times. The sensor performs a total of three transmission attempts.  
If no confirmation is received from the LoRa network server after the third attempt, the sensor discards the current message. After the set LoRa transmission interval has expired, the sensor then rejoins the LoRa network. It then records new measurement values, which are then transmitted again with a request of a receipt confirmation.

Usually, LoRaWAN sends the measurement data from devices to the gateway "Unconfirmed." This reduces the load on the LoRaWAN network and allows multiple messages to be received simultaneously on different gateway channels. This also means messages can be received in most events. Of course, especially with this type of transmission, messages from one or more devices may not be received by the gateway.

If it is necessary to ensure that a message is received at the gateway, the message type should be "Confirmed." This could be the alarm signal of a smoke detector or when using the WILSEN products as overflow protection or similar, for example. In this case, however, it should be noted that for each message from each device set up in this way, a receipt confirmation is requested/required by the gateway. While the gateway is sending this receipt confirmation, the high signal strength means it is not possible to receive other messages on the gateway at the same time. This quickly overloads the LoRa network, especially in the case of a high number of communications with requested confirmation. It may also be the case that no other messages can be received.

For this reason, there is a general time limit for the downlink transmission capacity for LoRaWAN gateways. This relates to the transmission of data from the gateway toward the devices. LoRaWAN gateways may only use a maximum of 10 % of their total operating time to send downlink messages. In other words, 90 % of the time the gateway must be available to receive messages.

---

### Note

The selected message type applies to the transmission of all sensor payloads.

You should only select a "Confirmed" transmission of the measured values if necessary to your application. In this case, the measurement/transmission interval must also be set as long as possible.

---



## Number of Transmissions



### Note

This parameter is only available if the message type is set to "Unconfirmed."

You can choose between the values "1" and "3" as the number of message transmissions (payload).

- With "1," the sensor sends each message (payload) toward the gateway only once.
- With "3," each message is sent a total of three times at short intervals.

Multiple transmissions of the same message increases the probability that each message will actually arrive at the gateway and therefore the IoT system if the message transmission is "Unconfirmed." This also increases the utilization of the LoRa wireless network. In a LoRaWAN network operating near the network capacity limit or with high utilization, there may be an increased likelihood of telegram collisions between different sending devices. Messages sent simultaneously from different devices overlap on the wireless transmission path. On the receiving side, this can cause these messages to become inconsistent and therefore be discarded. Multiple transmissions of the same message in LoRaWAN networks with high utilization can therefore thwart the actual intention of increasing the probability of receiving the message on the gateway side.



### Note

The number of transmissions set applies to the transmission of all sensor payloads.

Care must be taken when selecting the transmission frequency of a message, as it must be appropriate for your application.

## Spreading Factor

The spreading factor is a LoRaWAN parameter that is used to set the transmission strength and data rate of the device. These values depend on the individual influences and conditions on the wireless link between the device and the gateway.

The following two relationships apply:

- Device: The higher the spreading factor, the higher the transmitting power and longer the transmission duration and therefore also the higher the energy consumption in the sending device.
- LoRaWAN network: The higher the spreading factor, the longer the data transmission, and therefore the higher the load/occupancy of the LoRaWAN network.

Further details can be found at <https://loro-alliance.org/about-lorawan/>.

In most applications, "Automatic (ADR)" (Adaptive Data Rate) is the appropriate setting. In this case, the LoRa network server regulates the sensor's spreading factor to a degree that is appropriate to the actual conditions of the wireless link. First, the wireless transmission begins after the sensor joins/rejoins the LoRa network with a high spreading factor. This ensures that the first transmissions are successful even under poor conditions. The spreading factor is gradually reduced depending on the signal strength received and the signal-to-noise ratio. The LoRaWAN network server performs this task.

The "Automatic (ADR)" setting usually represents the optimal compromise between energy consumption for wireless transmission, low load on the LoRaWAN wireless network due to short transmission time and good reliability of data reception on the server side.

In some applications, there are no stable conditions on the wireless link and changes in the environmental influences or EMC influences occur. Both can lead to unreliable transmission of the measured values.

There are also applications in which there is essentially only poor LoRaWAN wireless coverage. For example, this could be in an urban environment with only a few gateways that may be positioned very far away and/or with sensor locations that are heavily shielded in terms of wireless technology.



In such circumstances, the "Automatic (ADR)" setting may not work reliably. Either no data can arrive at the gateway or only sporadically, i.e. with dropouts. For these applications, a fixed setting of the spreading factor is usually advantageous—usually a high setting such as SF11 or SF12.

Conversely, there are also applications in which a very good LoRa network coverage is ensured. In such a case it can also be advantageous to set the spreading factor to a fixed value. We recommend low settings such as SF7 or SF8. Therefore, even when the sensor joins/rejoins, the spreading factor is directly adapted to the very good conditions, which means a lower energy consumption than with "ADR."



---

#### Note

The selected spreading factor applies to the transmission of all payloads of the device.

To ensure the longest possible battery life, select a spreading factor appropriate to your application. Avoid unnecessarily high settings.

---

#### Data Transfer

As long as the "Data Transmission" parameter is enabled in the "LoRaWAN Configuration" menu, the sensor sends the data contained in "Payload 1;" see separate document "Payload Description." The frequency of LoRa transmission and the time schedule are defined using the additional parameters "Transmission Interval" and "Next Transmission."

#### Transmission Interval

This parameter determines the time intervals at which the data is transferred. If "6h" is selected, the sensor sends its data every six hours. The start time of the interval can be controlled using the "Next Transmission" parameter.



---

#### Caution!

Observe the maximum permissible transmission time per device!

Legal regulations in Europe allow a maximum permissible transmission time ("air time"/"duty cycle") of 1 % per hour for the use of the 868 MHz band per device. If the "Transmission Interval" parameter is set to a value of at least 30 minutes, this requirement is fulfilled regardless of the other influencing factors. A LoRa transmission interval of less than 30 minutes may only be set for a short time. If such a setting is configured in the app, a corresponding message is displayed and the parameter is reset to the last non-critical value as soon as the app connection to the sensor is terminated.

The user is responsible for complying with the 1 % target. Failure to comply with this requirement may result in criminal penalties.

Please note that in other countries, based on legal requirements or those from LoRa network operators and other institutions, additional, possibly stricter restrictions may apply, and must be observed.

---

#### Next Transmission

This parameter determines the start time of the send interval. If set to "5 min.," for example, the first data transfer of the set interval takes place five minutes after the changed settings have been transmitted to the sensor by tapping the "Apply" button.

By configuring this parameter, it is also possible to define a transmission time within a specific time frame for a number of sensors, e.g., "always in the first quarter of an hour."



---

#### Note

To ensure the longest possible battery life, select a transmission interval appropriate to your application. However, avoid setting an "unnecessarily short" interval and therefore a "too frequent" measurement and transmission.

---



**Note**

The transmission frequency set via the "LoRaWAN Configuration" menu relates exclusively to "Payload 1" (= measured data without GPS position data).

The transmission frequency of "Payload 2" (= measured data including GPS position data) is defined using the "Acquisition Interval" parameter in the "GPS Config." menu. The sensor heartbeat (= Payload 3) is transmitted at a fixed, unchangeable time interval of "once per day."

For details, see the "Payload Description" additional document. You can download the payload description for your WILSEN.sonic.level online from the product detail page for the relevant WS-UCC\*-F406-B15-B41-\* wireless ultrasonic sensor at [www.pepperl-fuchs.com](http://www.pepperl-fuchs.com). See the Documents area

**"Apply" Button**

Any changes made to parameters are only transferred to the sensor once the "Apply" button has been pressed; they are then saved to the sensor permanently.

A payload transmission according to adjusted LoRaWAN settings first takes place after the time set in the "Next Transmission" parameter has expired. Therefore, when you tap the "Apply" button, a corresponding countdown timer is displayed at the bottom of the LoRaWAN configuration menu. After the first transmission and therefore also during normal operation of the sensor, this countdown counter in the app is hidden again.

## 7.6 Device Configuration Submenu

The **Device configuration** submenu displays the device name and allows you to disable the Bluetooth interface of the sensor, change the device password, reset the device to factory settings, and reset the counters.

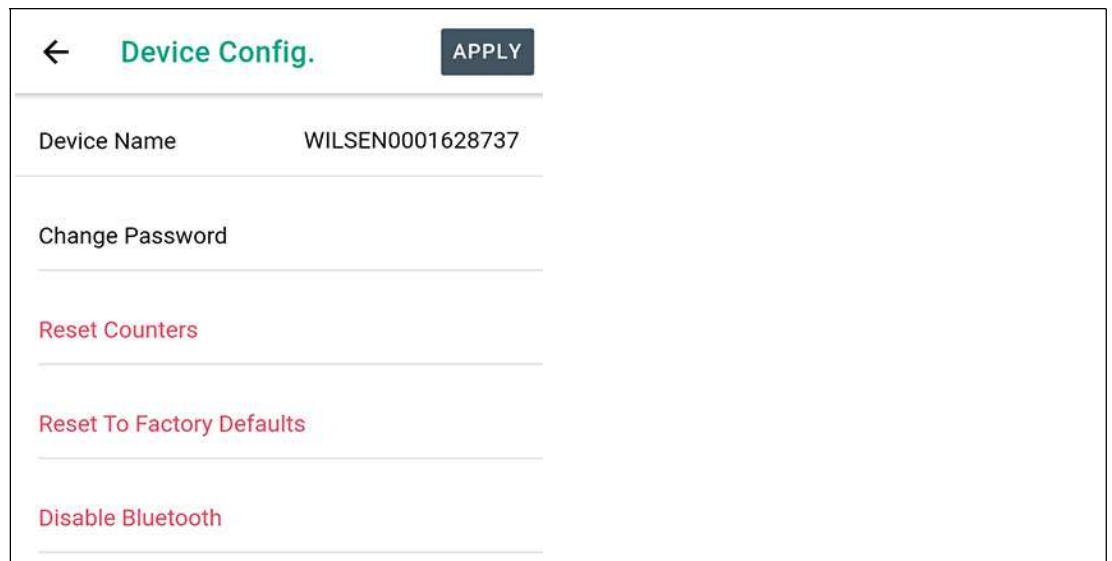

Figure 7.8

### Device Name

The device name currently assigned to the device is displayed here. You can change this by tapping the name and customizing it using the keyboard that appears.

### Change Password

Here you can change the password for accessing the sensor via the Bluetooth interface. The default value for the password is "00000000."

As a password, you can enter an unlimited number of alphanumeric characters and special characters from the UTF-8 character range.

To ensure a sufficient level of security, we strongly recommend that when the device is commissioned the sensor password is changed so that it differs from the default password. The new password should consist of at least eight characters and should also be changed at regular intervals in the future.



### Caution!

Note the new password to access the device in the future.

Write down the new password in a secure location. A forgotten or lost password cannot be reset or retrieved by the user or manufacturer.

### Reset counters

Use this button to reset the counters that are running in the sensor to monitor the frequency of ultrasonic measurements, GPS position detection and LoRa transmissions. This may be useful after a battery replacement.



### Note

The current counter readings can be found in the "Sensor Information" menu and are cyclically transmitted in a trimmed-down form with the sensor heartbeat ("Payload 3") via LoRaWAN.

Only the "counter readings since last reset" can be reset. The "total counter readings" are continuously updated from the production of the sensor and cannot be reset.

### Reset To Factory Defaults

This button takes you to another submenu where three reset options are provided.

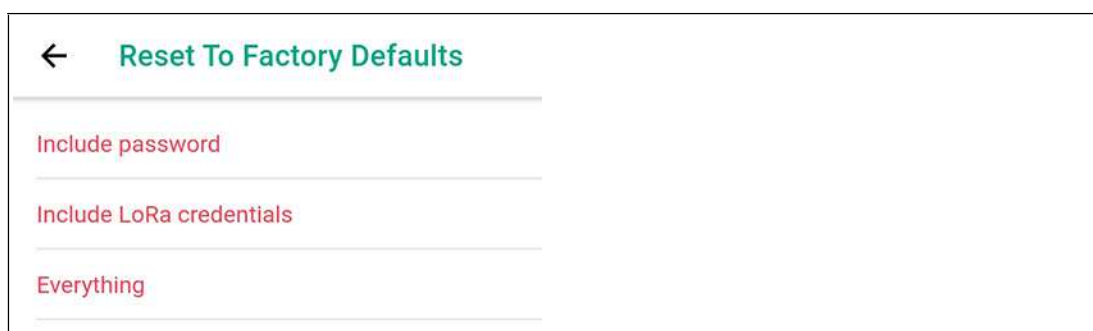

Figure 7.9

#### Include password

If you select this option, all device parameters, including the password, are reset to the factory settings. The LoRa credentials will remain unchanged.

#### Include LoRa credentials

If you select this option, all device parameters, including the LoRa credentials, are reset to the factory settings. The password will not be reset.

#### Everything

If you select this option, all device parameters, including the password and LoRa credentials, are reset to the factory settings. The sensor will revert completely to the same state in which it was delivered.

### **Disable Bluetooth**

This button can be used to deactivate the Bluetooth interface of the sensor. This may be useful after commissioning and parameterizing the sensor to make unauthorized access to the sensor even more difficult.

You can only reactivate the Bluetooth interface by disconnecting the battery for approximately ten seconds and then reconnecting it. The Bluetooth interface is then available again as usual.



---

### **Note**

Please note that deactivating the Bluetooth interface will immediately stop contact with the sensor through the app. In this case, the sensor can no longer be found in the device search list of the app.

---

## 7.7 Device Information Submenu

The **Device information** submenu contains a variety of information about the device, such as device data and counter readings. In addition, it includes the function for updating the firmware "over-the-air" .

← Device Info	
Part Number	70124842
Type Code	WS-UCC2500-F406-B15-B41-01-02
Device Type	WILSEN.sonic.level LoRa
Manufacturer	Pepperl+Fuchs
Serial Number	48000001628737
Hardware Revision	1.3.03
Firmware Revision	2.1.12
 Update Firmware	
Counters	
Ultrasonic Measurem...	
Total	11826
Since last reset	11826
LoRa Transmissions	
Total	5843
Since last reset	5843
GPS Acquisitions	
Total	2922
Since last reset	2922
Counter Resets	0

Figure 7.10

### Firmware update

By pressing this button, an update of the device firmware is performed "over-the-air" after a confirmation prompt. Using the internet connection of the mobile device you are using, a newer version of the firmware is downloaded and then installed on the device.



---

**Note**

If a more up-to-date version is available, executing this function will overwrite the existing firmware on the device without any further prompt. Some device parameters may be reset to their factory settings.

After updating to a newer firmware version, it is not possible to revert to an earlier firmware version.

---

**Counter**

The device logs the execution frequency of some functions. The collected data is displayed under the heading "Counters." In each case, the frequency since the device was produced (= "Total counter readings") and the frequency since the last reset of the counter readings are displayed.

In addition, the number of times the counter readings in the current device have already been reset by the user is displayed under "Counter Resets." This data also provides information about the life status and the history of the device.

## 8 Servicing

The device itself is maintenance-free. For this reason, it is not necessary to carry out regular adjustments or maintenance work on the device itself.

However, check that the device is securely fitted at the installation location within the scope of routine maintenance intervals.

## 9 Replacing the Battery

The device battery is replaceable. Replacement batteries are available from Pepperl+Fuchs.

The device battery is designed for a long service life. The energy consumption of the device depends on the device parameterization and the conditions at the operating location, such as the distance between the device and the LoRa gateway, and climatic conditions.



### Warning!

Risk of injury if battery is defective!

This device uses a high-energy cell for voltage supply. This battery contains lithium and thionyl chloride. If these substances are released, the appropriate protective measures must be observed. Refer to the safety data sheet.

In case of leakage, contact with the skin or eyes may cause severe irritation and burns. Inhalation of electrolyte vapors may affect the upper respiratory tract and lungs.



### Note

The safety data sheet for lithium-thionyl chloride batteries can be found online at [www.pepperl-fuchs.com](http://www.pepperl-fuchs.com), on the product detail page for the respective wireless ultrasonic sensor WS-UCC\*-F406-B15-B41-\* under "Documents."



### Warning!

Non-genuine batteries jeopardize operational safety.

Use only genuine replacement batteries from Pepperl+Fuchs; otherwise the function and safety of the device cannot be guaranteed. At worst, unapproved batteries can result in personal injury or property damage due to fire or may become discharged earlier than genuine batteries.



### Note

#### Observe the following rules when replacing the battery

- Before opening the device, make sure that moisture cannot penetrate the device and, if necessary, rub the device dry.
- Before opening the device and while opening, check that the battery to be replaced is intact and that no chemicals have leaked out. If this is the case, stop the replacement procedure immediately and close the enclosure. Observe the information in the safety data sheet for the battery.
- Make sure that the new battery is well secured in the device by the hook-and-loop tape.
- Make sure that the battery connection cable is only routed inside the device and cannot be clamped when the enclosure cover is closed.





Figure 9.1

1. Open the locking mechanism of the enclosure using a screwdriver.
2. Open the enclosure cover.

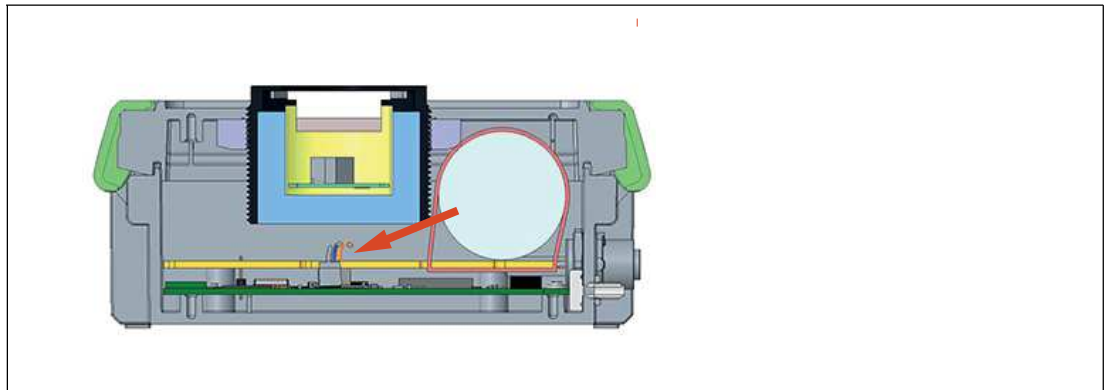

Figure 9.2

3. Carefully pull the plug of the battery connection cable out of the connector.
4. Detach the hook-and-loop tape securing the battery and remove the old battery.
5. Dispose of in accordance with local regulations.
6. Insert the new battery into the intended installation position and secure it with the hook-and-loop tape.
7. Plug the battery connection cable on the motherboard into one of the white connectors. Since the cables are connected internally, the plug-in position does not matter.
8. Check that the LED briefly lights up. This indicates that the device is ready for operation.



**Caution!**

Do not clamp the battery cable.

When closing the enclosure cover, take care to ensure that the battery connection cable is completely in the enclosure and is not clamped by the closing edge.

9. Close the enclosure cover and snap the device locking mechanism into place.



**Note**

After replacing the battery, it may be useful to reset the sensor's operating counters. If you want to do this, launch the WILSEN app on your mobile device and switch to the "Device configuration" menu. Select the "Reset Counters" function ( See chapter 7.6).

## 10 Cleaning

It is not necessary to clean the device regularly.

If cleaning is required, please observe the following general rules:

- Only with water without chemicals
- Without pressure / high pressure
- Only by using a soft cloth
- No abrasive cleaning, scratching, or scrubbing

## 11 Repair

The device must not be repaired, changed, or manipulated. In case of failure, always replace the device with an original device.

## 12 Disposal

The device, built-in components, packaging, and any batteries contained within must be disposed in compliance with the applicable laws and guidelines of the respective country.

# Your automation, our passion.

## Explosion Protection

- Intrinsic Safety Barriers
- Signal Conditioners
- FieldConnex® Fieldbus
- Remote I/O Systems
- Electrical Ex Equipment
- Purge and Pressurization
- Industrial HMI
- Mobile Computing and Communications
- HART Interface Solutions
- Surge Protection
- Wireless Solutions
- Level Measurement

## Industrial Sensors

- Proximity Sensors
- Photoelectric Sensors
- Industrial Vision
- Ultrasonic Sensors
- Rotary Encoders
- Positioning Systems
- Inclination and Acceleration Sensors
- Fieldbus Modules
- AS-Interface
- Identification Systems
- Displays and Signal Processing
- Connectivity

### Pepperl+Fuchs Quality

Download our latest policy here:

[www.pepperl-fuchs.com/quality](http://www.pepperl-fuchs.com/quality)

