

VBG-EP1-KE5-D*

ASi-3 Gateway

Firmware Version 2.8

Manual



EtherNet/IP™

Your automation, our passion.

 **PEPPERL+FUCHS**

With regard to the supply of products, the current issue of the following document is applicable:
The General Terms of Delivery for Products and Services of the Electrical Industry, published
by the Central Association of the Electrical Industry (Zentralverband Elektrotechnik und Elek-
troindustrie (ZVEI) e.V.) in its most recent version as well as the supplementary clause:
"Expanded reservation of proprietorship"

Worldwide

Pepperl+Fuchs Group
Lilienthalstr. 200
68307 Mannheim
Germany
Phone: +49 621 776 - 0
E-mail: info@de.pepperl-fuchs.com

North American Headquarters

Pepperl+Fuchs Inc.
1600 Enterprise Parkway
Twinsburg, Ohio 44087
USA
Phone: +1 330 425-3555
E-mail: sales@us.pepperl-fuchs.com

Asia Headquarters

Pepperl+Fuchs Pte. Ltd.
P+F Building
18 Ayer Rajah Crescent
Singapore 139942
Phone: +65 6779-9091
E-mail: sales@sg.pepperl-fuchs.com
<https://www.pepperl-fuchs.com>

1	Introduction.....	7
1.1	Content of this Document.....	7
1.2	Target Group, Personnel	7
1.3	Symbols Used	8
1.4	Intended Use	8
1.5	General Safety Instructions	9
1.6	Declaration of Conformity.....	9
2	Cybersecurity Information.....	10
3	Product Description	12
3.1	Use and Application	12
3.2	Indicators and Operating Elements	14
3.3	Dimensions.....	18
4	Installation.....	19
4.1	Electrical Connection	19
4.1.1	Interfaces and Connections	20
4.1.2	Connecting the AS-Interface and Supply Voltage	20
4.1.3	Ethernet Connection.....	23
4.1.4	Connection to Configuration Interface X3	24
4.1.5	Micro SD Card	24
4.2	Mounting and Dismounting	26
5	Commissioning.....	29
5.1	Addressing the AS-Interface	29
5.2	PROFINET	29
5.2.1	Preparation	29
5.2.1.1	Configuration	29
5.2.1.2	Online Assignment of the Device Name.....	31
5.2.1.3	Factory Reset.....	33
5.2.1.4	Configuration of the Gateway Slots	36
5.2.1.5	Device Replacement Without Exchangeable Medium/Programming Units	38
5.2.1.6	Watch and Force Tables	39
5.2.2	Modules.....	45
5.2.2.1	Digital Data	45
5.2.2.2	Analog Data	47
5.2.2.3	AS-Interface Diagnostic Information.....	49
5.2.2.4	Command Interface	52
5.2.2.5	Gateway Record Modules.....	55
5.2.3	Channel Diagnosis	57

5.3	EtherNet/IP	61
5.3.1	Preparation	61
5.3.2	Configuration	64
5.3.2.1	Connections and Assembly Objects	64
5.3.2.2	Configuration Parameters	65
5.3.2.3	Configuration Example	66
5.3.3	Bit Assignment of the Process Data	70
5.3.4	EtherNet/IP Class 3 Objects	97
6	Operation	108
6.1	Push Button	108
6.2	Web Interface	110
6.2.1	Login	111
6.2.2	Dashboard	113
6.2.3	AS-Interface	117
6.2.4	System	128
6.2.4.1	Events	129
6.2.4.2	Fieldbus Protocol	129
6.2.4.3	Network Interfaces	130
6.2.4.4	Firmware Update	131
6.2.4.5	Data Backup	131
6.2.4.6	Factory Settings	133
6.2.4.7	Restarting	134
6.3	Configuration Interface X3	134
6.4	REST API	134
7	Servicing and Overhaul	135
8	Annex A: PROFINET Command Interface Commands and Data Layout	136
8.1	Get Permanent Parameter	136
8.2	Write Parameter	136
8.3	Read Parameter	137
8.4	Store Actual Parameters	137
8.5	Store Actual Configuration	138
8.6	Set Offline Mode	138
8.7	Set Auto Address Enable	139
8.8	Set Operation Mode	140
8.9	Change Slave Address	141
8.10	Set Permanent Configuration	141
8.11	Get Permanent Configuration	142
8.12	Read Actual Configuration	142
8.13	Set LPS	143

8.14	Get LPF	144
8.15	Write Extended ID1 Code.....	145
8.16	Set Permanent Parameter	145
8.17	Get LPS	146
8.18	Get LAS.....	146
8.19	Get LDS.....	147
8.20	Get Flags	148
8.21	Set Data Exchange Active.....	149
8.22	Get Delta List.....	150
8.23	WRITE_74_75_PARAMETER.....	151
8.24	READ_74_75_PARAM	152
8.25	READ_74_75_ID	153
8.26	READ_74_DIAG.....	154
8.27	TRANSFER_75	155
8.28	Get LCS.....	158
8.29	Get Auto Address Enable.....	159
8.30	Set Motor Control (G20) Config	160
9	Annex B: PROFINET Record Commands and Data Layout.....	161
9.1	Read IDI 0x01	161
9.2	Write ODI 0x02	162
9.3	Set Permanent Parameter	163
9.4	Get Permanent Parameter 0x04	163
9.5	Read Parameter 0x06	164
9.6	Set Permanent Configuration 0x08.....	165
9.7	Get Permanent Configuration 0x09.....	166
9.8	Read Actual Configuration 0x0B	166
9.9	Set LPS 0x0C.....	167
9.10	Get LPS 0x0D	168
9.11	Get LAS 0x0E	168
9.12	Get LDS 0x0F	169
9.13	Get Flags 0x10	170
9.14	Set Operation Mode 0x11.....	170

9.15	Set Offline Mode 0x12	171
9.16	Set Data Exchange Active 0x13.....	172
9.17	Change Node Address 0x14	173
9.18	Set Auto Address Enable 0x15.....	173
9.19	Get Auto Address Enable 0x15.....	174
9.20	Get LPF 0x17	175
9.21	Write ID1 Code 0x18	176
9.22	Read AIDI 0x19	177
9.23	Write AODI 0x1A.....	178
9.24	Get Delta List 0x40.....	179
9.25	Get LCS 0x41	180
9.26	Write Parameter 0x42	181
9.27	Read Node Response to Write Parameter 0x42	181
9.28	Reset Node 0x43	182
9.29	Read Node Response to Reset Node 0x43.....	183
9.30	Select Node 0x44	184
9.31	Store Actual Parameters 0x45	184
9.32	Store Actual Configuration 0x46	185
9.33	Set Motor Control (G20) Config 0x47.....	186

1 Introduction

1.1 Content of this Document

This document contains information required to use the product in the relevant phases of the product life cycle. This may include information on the following:

- Product identification
- Delivery, transport, and storage
- Mounting and installation
- Commissioning and operation
- Maintenance and repair
- Troubleshooting
- Dismounting
- Disposal



Note

For full information on the product, refer to the further documentation on the Internet at www.pepperl-fuchs.com.



Note

For specific device information such as the year of construction, scan the QR code on the device. As an alternative, enter the serial number in the serial number search at www.pepperl-fuchs.com.

The documentation comprises the following parts:

- This document
- Datasheet

In addition, the documentation may comprise the following parts, if applicable:

- EU-type examination certificate
- EU declaration of conformity
- Attestation of conformity
- Certificates
- Control drawings
- Instruction manual
- Functional safety manual
- Other documents

1.2 Target Group, Personnel

Responsibility for planning, assembly, commissioning, operation, maintenance, and dismantling lies with the plant operator.

Only appropriately trained and qualified personnel may carry out mounting, installation, commissioning, operation, maintenance, and dismantling of the product. The personnel must have read and understood the instruction manual and the further documentation.

Prior to using the product make yourself familiar with it. Read the document carefully.

1.3 Symbols Used

This document contains symbols for the identification of warning messages and of informative messages.

Warning Messages

You will find warning messages, whenever dangers may arise from your actions. It is mandatory that you observe these warning messages for your personal safety and in order to avoid property damage.

Depending on the risk level, the warning messages are displayed in descending order as follows:



Danger!

This symbol indicates an imminent danger.

Non-observance will result in personal injury or death.



Warning!

This symbol indicates a possible fault or danger.

Non-observance may cause personal injury or serious property damage.



Caution!

This symbol indicates a possible fault.

Non-observance could interrupt the device and any connected systems and plants, or result in their complete failure.

Informative Symbols



Note

This symbol brings important information to your attention.



Action

This symbol indicates a paragraph with instructions. You are prompted to perform an action or a sequence of actions.

1.4 Intended Use

The VBG-EP1-KE5-D* is a gateway for one or two networks in accordance with AS-Interface Specification 3.0, Revision 6. The gateway is used to connect AS-Interface nodes to higher-level control systems.

Read through this manual carefully. Be sure to familiarize yourself with the gateway before mounting, connecting, and operating.

Operate the gateway only as described in this manual. Make sure that the device and the systems connected to the device work correctly.



Caution!

Equipment Protection

Use the device only as specified by the manufacturer. Otherwise, the protection provided by the device may be impaired.

1.5 General safety instructions

Responsibility for planning, assembly, commissioning, operation, maintenance, and dismantling lies with the plant operator.

Installation and commissioning of all devices may be performed only by trained and qualified personnel.

It is dangerous for the user to make changes and/or repairs. Additionally, doing so voids the warranty and excludes the manufacturer from any liability. In the event of any serious errors, stop using the device. Secure the device against unintended operation. To have the device repaired, return it to your local Pepperl+Fuchs representative or your sales center.



Note

Disposal

Electronic waste is dangerous. When disposing of the equipment, observe the current statutory requirements in the relevant country of use and local regulations.

1.6 Declaration of Conformity

This product was developed and manufactured in line with the applicable European standards and directives.



Note

A declaration of conformity can be requested from the manufacturer.

The product manufacturer, Pepperl+Fuchs Group, 68307 Mannheim, Germany, has a certified quality assurance system that conforms to ISO 9001.



ISO9001

2 Cybersecurity Information

The VBG-EP1-KE5-D* gateway is secure for the area of application defined here in accordance with IEC 62443-4-1. The operator must implement the measures defined in this section to ensure the secure operation and protection of the device while online.

Security Context

The VBG-EP1-KE5-D* is intended for use in an automation network. This is a secure network with known and trusted participants that is separated (physically or logically) from the company network.

A firewall must be configured so that only defined ports are forwarded to other subnets.

The device uses the following ports:

- Ports 49152, 34964 for PROFINET
- Port 2222 and port 44818 for EtherNet/IP
- Port 68 DHCP client
- Port 80 for the administration website using HTTPS

To avoid losing packets, we recommend limiting the network load to < 5 % of the bandwidth. We recommend operating the gateway behind a network switch.

The device must be physically secured against unauthorized access and operated in a lockable switch cabinet or room that is only accessible to authorized personnel. Otherwise, there is a risk that the "X3" service interface and the password printed on the gateway will be used¹ Some of the device settings can be changed.

The device contributes to the "defense-in-depth" strategy with the following security functions:

Security function	Addressed threat
Access control with single-factor authentication (SFA) and automatic time-based login lock in the event of incorrect authentication.	Protection against unauthorized access, brute-force attacks.
Delete all information stored in the device using the "Reset to factory settings" function.	Protection against information being spied by physical access to the device after decommissioning and disposal by the system operator.
The access data is hashed by the SHA1 cryptographic hash function with salt and pepper	Protection against reading and recalculation of a password or finding a collision, e.g., with "Rainbow table." Even in the unlikely event that this would be possible, this would have to be repeated for each individual device, since results cannot be transferred to other devices, even if the same password is used.
The device-specific 15-digit password must be entered for commissioning using the web interface. It is therefore not possible to commission an unprotected function of the device.	Protection against accidentally active unprotected functions and services without access control, incorrect configuration or an incomplete configuration, which can then be exploited by unauthorized persons.

1. if left unchanged

The Following Measures Must Be Implemented on the Device for Commissioning:

- Hardening: Change the device-specific password printed on the device.
- Special security functions: Access control with single factor authentication (SFA)
Automatic login lock if access data is entered incorrectly after the seventh attempt for a duration of 1 minute to protect against brute-force attacks.
The access data is hashed multiple times by the SHA1 cryptographic hash function with salt and pepper.

The Following Settings Must Be Implemented on the Device for Operation:

- Additional security layers: Password change: every 2 years.
- Servicing and management: Check the website regularly for the release of security advisories and subscribe to the RSS feed: <https://www.pepperl-fuchs.com/global/en/29079.htm>.

The following measures must be implemented on the device for decommissioning:

- User access data: Delete using the "Reset to factory settings" function.
- Configuration: Delete using the "Reset to factory settings" function.
- Log data (history, historical data, and error data): Stored only temporarily and deleted after a restart.

Requirements for User Roles to Ensure Cybersecure Operation

- Administrator: Implement the measures defined in "The following measures must be implemented on the device for operation."
If applicable: Update the firmware and install security patches.

User Account Privileges and Rights

- Administrator: Switching functions on and off
Configuration
Reset to factory settings
Read the log and device status
Firmware updates

3 Product Description

3.1 Use and Application

The VBG-EP1-KE5-D* is a gateway for one or two networks in accordance with AS-Interface Specification 3.0. The gateway is used to connect AS-Interface nodes to higher-level controllers. In each AS-Interface network, you can connect up to 31 nodes in the standard addressing mode or up to 62 nodes in the extended addressing mode. The nodes are usually connected to the flat cable via piercing technology. The network length can be up to 100 meters. The maximum length can be extended several times over by using repeaters and terminators. The design of the network is characterized by complete topological flexibility.

Product Versions

Name	Function
VBG-EP1-KE5-D.	Gateway for one network in accordance with AS-Interface Specification 3.0
VBG-EP1-KE5-DMD	Gateway for two networks in accordance with AS-Interface Specification 3.0



Note

The manual describes the VBG-EP1-KE5-DMD with the operation of two AS-Interface segments. The manual also applies to the VBG-EP1-KE5-D, which operates one ASI segment.



Figure 3.1

Special Product Features

Multiprotocol Function

- With the multiprotocol function, you can select EtherNet/IP or PROFINET as the protocol of the industrial network, depending on the application. The protocol can be changed using the push button.

Integrated Web Server

- The gateway has an integrated web server for module management, simple commissioning, and diagnostic purposes. The AS-Interface networks can be configured via a standard web browser. During operation, you can view and correct faults in the network, the gateway, and the connected nodes. This is done directly on the gateway or via remote maintenance with a corresponding connection.

Using the Gateway in a Switch Cabinet

- The gateway features degree of protection (IP20) and has a width of less than 40 mm, making it ideal for use in switch cabinets. The gateway is supplied either via AS-Interface from AS-Interface segment 1 or via AUX. Spring terminals are available as connection options for voltage supply and for connecting the AS-Interface networks. The terminals are numbered and color-coded to prevent wiring errors.

Integrated Network Switch

- The integrated 2-channel Ethernet switch allows a line or ring topology to be set up in an industrial Ethernet. The firmware of the gateway supports ring topologies. With a ring topology, you can build a media-redundant network infrastructure. The gateway switches to an alternative ring segment immediately if the connection is interrupted. Continued operation is ensured after a network interruption.

System Overview

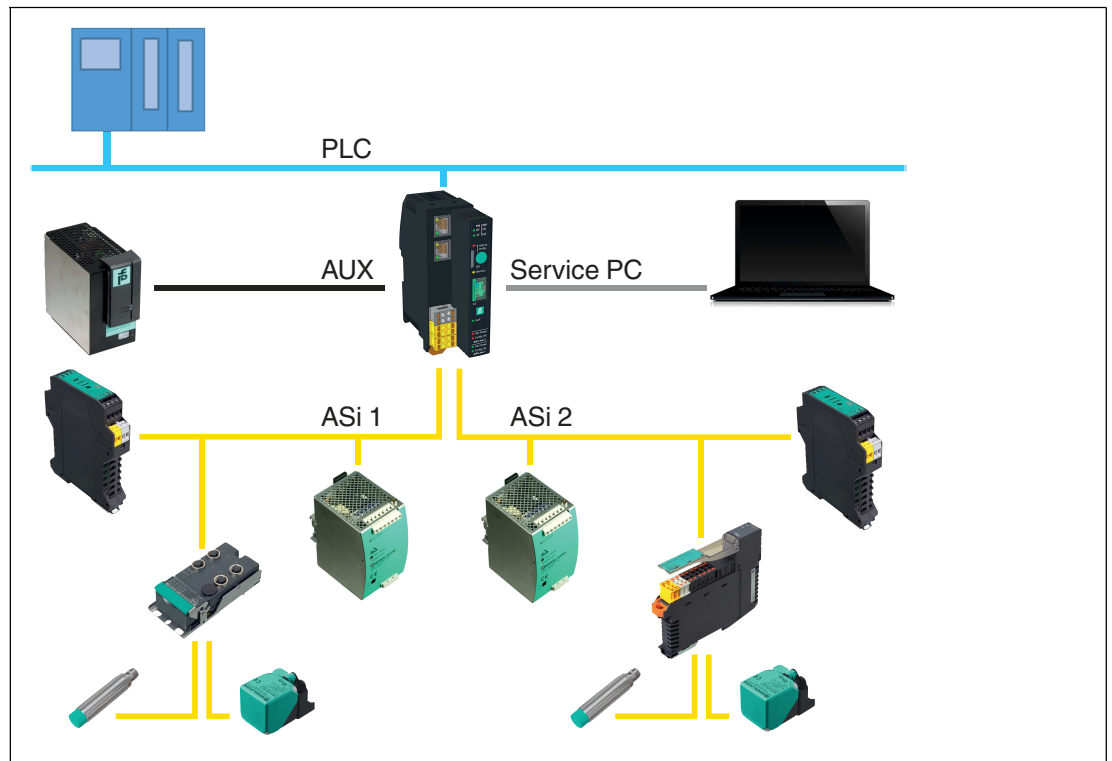

Figure 3.2 System overview

3.2 Indicators and Operating Elements

Indicators

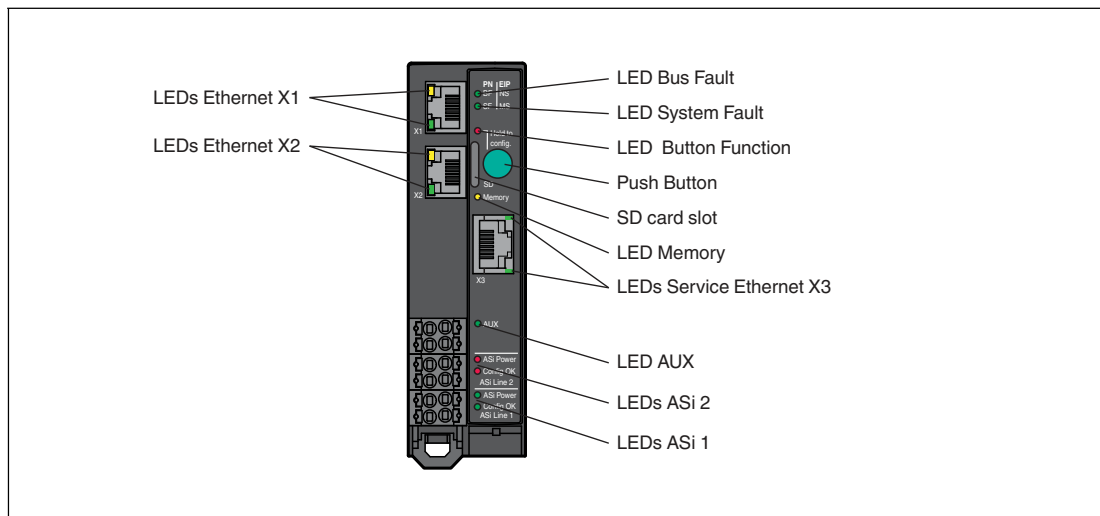

Figure 3.3

Designation		Function	Description
Ethernet X1		Status of interface X1	Status of the connection to an Ethernet device at interface X1
Ethernet X2		Status of interface X2	Status of the connection to an Ethernet device at interface X2
Service Ethernet X3		Configuration interface	Interface for configuring the gateway
SD card slot		Storage medium	For storage medium with configuration data
BF I NS		Bus error Network status	Status of the process data exchange with the fieldbus controller
SF I MS		System error Gateway status	Status of the system
Button function		Configuration storage status	Status of the storage of the current configuration
Memory		Memory status	Internal memory status, SD card
AUX		Supply voltage status	Status of gateway supply voltage
ASi line 1	ASi Power	Status of ASi 1 power supply	Status of the power supply of ASi network 1
	Config OK	Status of ASi 1 configuration	Status of the configuration of ASi network 1
ASi line 2	ASi Power	Status of ASi 2 power supply	Status of the power supply of ASi network 2
	Config OK	Status of ASi 2 configuration	Status of the configuration of ASi network 2

Status Indicator for Interface X1/X2/X3

Status	Description
■	Gateway is de-energized No network link to other Ethernet devices detected
■	Network communication active: Ethernet device detected

2023-06

Status	Description
	Packet exchange with other EtherNet/IP gateways Network communication active: Network link to another Ethernet device detected

Table 3.1 Ethernet X1, Ethernet X2, Service Ethernet X3

Status Indicator for Bus Errors, PROFINET Network Status





Status	Description
	Gateway is de-energized
	PROFINET communication with IO controller Connection established and data exchanged
	PROFINET communication with the IO controller has been interrupted
	No PROFINET communication with IO controller

Table 3.2 BF I NS

Status Indicator for Bus Errors, EtherNet/IP Network Status





Status	Description
	Gateway is de-energized Gateway does not have an IP address
	CIP connection (connection to scanner) established
	IP address configured There is no CIP connection
	Conflict with IP address detected
	CIP connection interrupted

Table 3.3 BF I NS

Status Indicator for System Errors







Status	Description
	Gateway is de-energized
	Gateway is ready and working correctly
	After switching on, "factory reset" mode is displayed
	An unrecoverable error has been detected
	A recoverable error has been detected
	Indicator check on startup

Table 3.4 SF I MS

Function Indicator for Push Button



Status	Description
	Gateway is de-energized Push button not working
	Function is locked
	Push button working

Table 3.5 Button

Status Indicator for Memory





Status	Description
	Gateway is de-energized No SD card present
	Saved configuration matches system configuration
	Configuration is saved
	The contents of the internal and external memory are inconsistent.
	Configuration failed to save (write problems, access problems, faulty configuration memory, teach-in failed)

Table 3.6 Memory

Status Indicator for Supply Voltage

Status	Description
	No AUX auxiliary power supply available
	AUX auxiliary power supply available

Table 3.7 AUX

Status Indicator for ASi 1/2 Power Supply







Status	Description
	System is off ASi network is not powered ASi network is not present
	ASi network is powered
	Configuration successfully saved via the button (flashes for five seconds)
	Short circuit to ground detected
	ASi network is selected for teach-in
	Error while saving the configuration via the button (flashes for five seconds)

Table 3.8 ASi Power

Status Indicator for Configuration of ASi 1/2

Status	Description
■	System is off No ASi nodes present
■	ASi communication in protected mode, configuration matches specification
⊠	ASi communication active in configuration mode, no configuration preset defined Teach-in via button successful (flashes for five seconds)
■	Diagnostic request present (gateway in LPF)
⊠	ASi network is selected for teach-in via button
■	Configuration of ASi network inconsistent in protected mode (missing or unexpected node)
⊠	Configuration of ASi network inconsistent in configuration mode (flashes alternately)
⊠	Teach-in (flashes for five seconds)

Table 3.9 Config OK

Status Indicator for Device Identification

Status	Description
⊠	All LEDs except Ethernet X1 – X3 LEDs flash to identify the device in PROFINET mode
⊠	All LEDs except Ethernet X1 – X3 LEDs flash at approximately 4 Hz to identify the device in EtherNet/IP mode
⊠	All LEDs except Ethernet X1 – X3 LEDs flash at approximately 2 Hz to check the LED function

Table 3.10 Device identification

Operating Elements

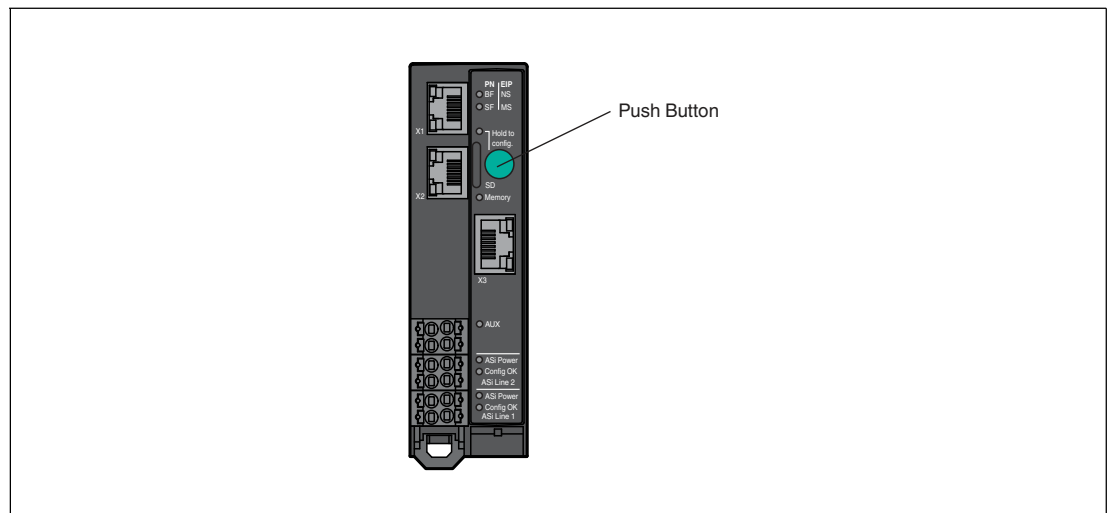

Figure 3.4

Designation	Description
Push button	Save the configuration, change the network protocol, or perform a factory reset for the gateway. See chapter 6.1.

3.3 Dimensions

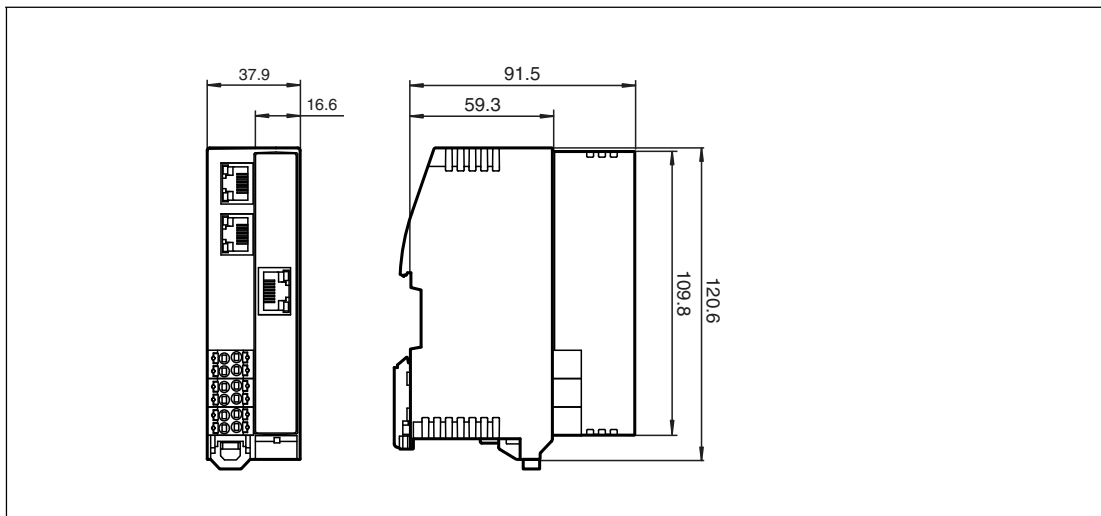

Figure 3.5 Dimensions in mm

4 Installation

4.1 Electrical Connection



Warning!

Electrical short caused by humidity

If the switch cabinet or switch box is not sufficiently sealed, this can lead to the loss of the specified degree of protection and the device function.



Note

Temperature Range of the Cable

The maximum operating temperature of the cables connected to the gateway must be at least 85 °C.

Wire Gauge

The following wire gauges can be used with the gateway.

<p>Open stranded wire: Core cross section 0.2 mm² ... 2.5 mm² Insulation stripping length L = 10 mm</p>	
<p>Cable end sleeve: Core cross section 0.2 mm² ... 1.5 mm² Insulation stripping length L = 10 mm</p>	

Ground Fault Detection

AS-Interface gateways feature an integrated ground fault detection. The gateway must be mounted on a metal DIN rail. This DIN rail must have a fixed connection to the metal components of the machine. The short circuit to ground may be caused by one of the following:

1. One of the ASI lines is connected to ground
2. An ASI-powered input is connected to ground
3. An ASI-powered output is connected to ground.

The short circuit to ground is displayed in the flag bits of the segment used.



Note

If lots of high impedance connections are made to earth, the short circuit to ground threshold may be lowered. In this case, a short circuit to ground could be reported, even if there is no short circuit to ground present.

4.1.1 Interfaces and Connections

Block Diagram

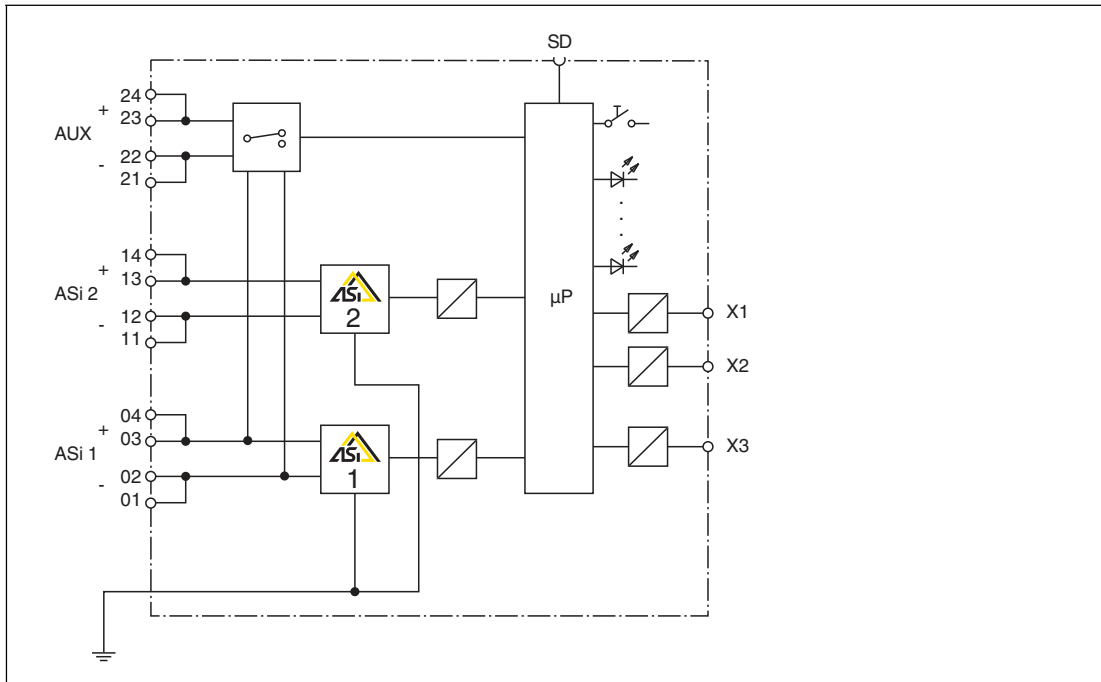

Figure 4.1

Connection	Designation	Description	Physical
X1	ETH1	Ethernet 1 for connection of fieldbus	RJ45 plug
X2	ETH2	Ethernet 2 for connection of fieldbus	RJ45 plug
X3	Service	Service interface for connecting service units	RJ45 plug
AUX	Power	Connection of auxiliary power supply	Terminal block
ASi 1	ASi Line 1	Connection for ASi segment 1	Terminal block
ASi 2	ASi Line 2	Connection for ASi segment 2	Terminal block

4.1.2 Connecting the AS-Interface and Supply Voltage

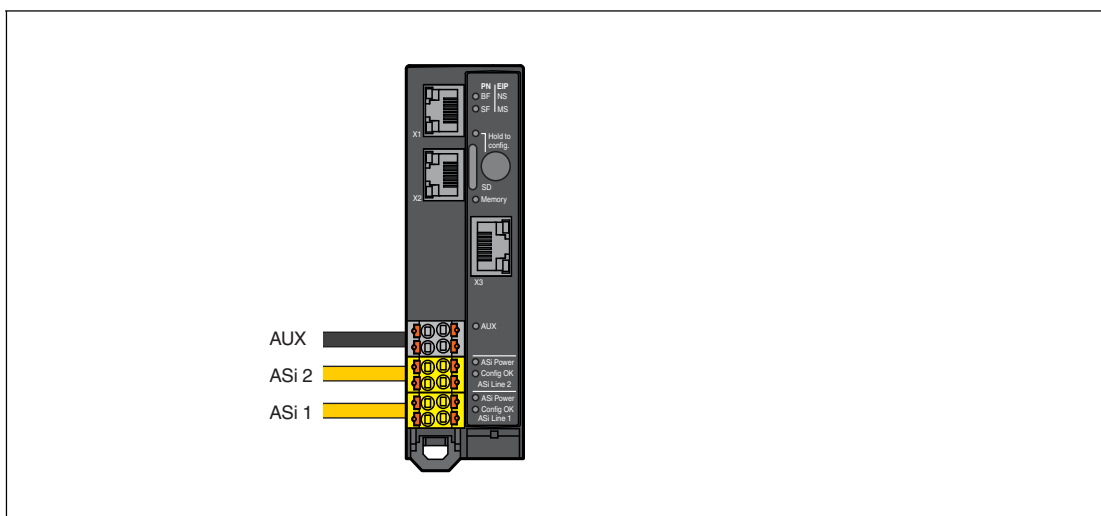

Figure 4.2

Terminal Blocks

The gateway has three terminal blocks for looping-through the ASi1, ASi2, and AUX lines. Each pair of terminals is bridged in the terminal block. This ensures the connection is retained even if the terminal block is disconnected from the gateway.

The bridges in the terminal blocks are designed for a current of 8 A and a core cross section $\geq 1 \text{ mm}^2$.

Assignment

Connection	Designation	Description
24 23	AUX +	AS-Interface gateway supply voltage Optional and redundant
22 21	AUX -	
14 13	ASi 2 +	AS-Interface segment 2 connection
12 11	ASi 2 -	
04 03	ASi 1 +	AS-Interface segment 1 connection
02 01	ASi 1 -	

If a corresponding voltage supply is connected, the device is automatically supplied via AUX. The AS-Interface segments each require their own compatible voltage supply. If there is no voltage supply connected via AUX, or if there is not sufficient voltage, the gateway is supplied via ASi 1.

You can use the AUX connection to provide auxiliary energy for connected nodes.



Note

Do not connect AS-Interface nodes or repeaters to the black AUX cable.
Do not connect any other AS-Interface gateways to the yellow ASi cable.



Warning!

The use of incorrect power supply units may lead to malfunctions.

Only supply the device via an AS-Interface power supply with integrated data decoupling that meets the requirements for safety extra-low protective voltage (SELV) or protective extra-low voltage (PELV).

Use a Class III, SELV or PELV power supply.



Releasing the Terminal Blocks

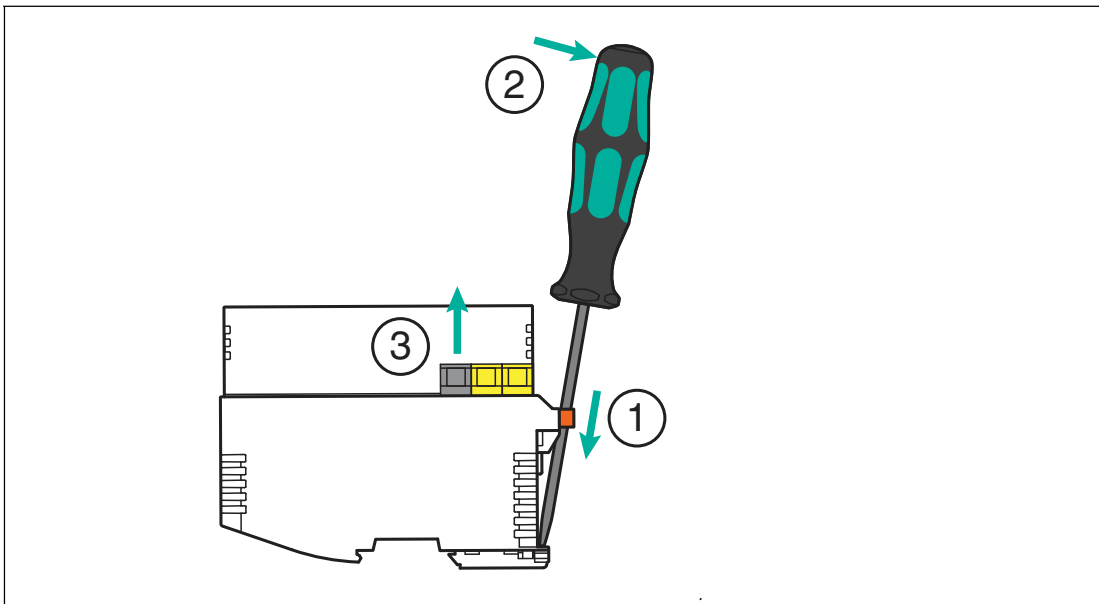

Figure 4.3 Releasing the terminal blocks

1. Insert a suitable screwdriver into the orange retaining clip until the blade is flush with the retaining clip of the DIN mounting rail.
2. Push the screwdriver outward to release the orange retaining clip.
↳ The terminal blocks are loosened.
3. Remove the terminal blocks.

AS-Interface Network Cable Connection

Cable type	Designation	Sheath color	Diagram
Yellow AS-Interface flat cable Black AUX flat cable	ASi +	Brown	
	ASi -	Blue	
Yellow AS-Interface round cable Black AUX round cable	ASi +	Brown	
	ASi -	Blue	

4.1.3 Ethernet Connection

The Ethernet interface for the fieldbus consists of two RJ45 sockets. The Ethernet interface corresponds to the IEEE 802.3 standard. To enable operation in a "daisy chain" series connection, terminals X1 and X2 are connected via an internal Ethernet switch.



Caution!

Area of application

Only connect the device to an internal Ethernet network. The device must not leave this network. Do **not** connect the device to the telecommunications network.

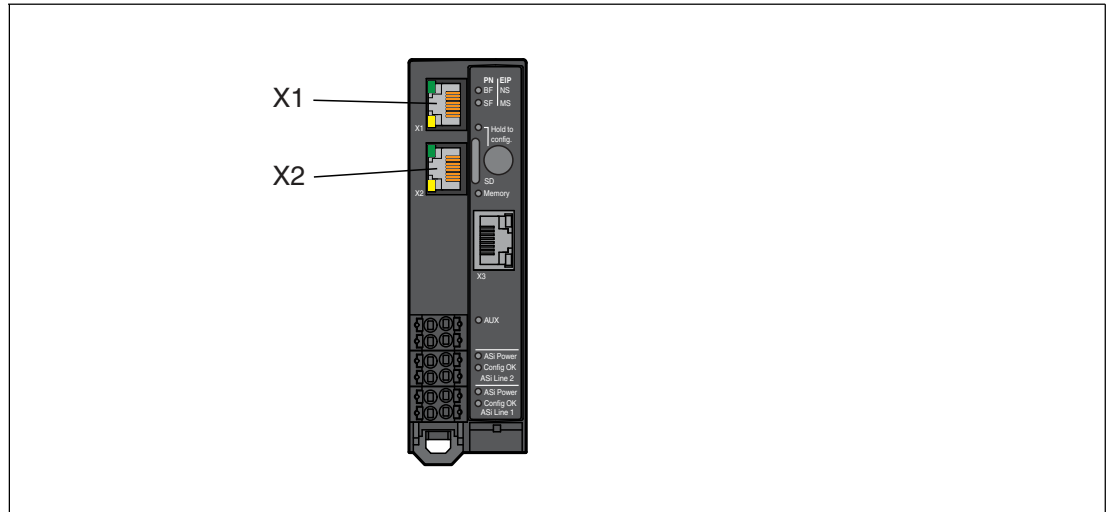

Figure 4.4

Assignment

Connection	Designation	Description
X1	ETH1	Ethernet connection 1 RJ45
X2	ETH2	Ethernet connection 2 RJ45

4.1.4 Connection to Configuration Interface X3

Configuration interface X3 consists of an RJ45 socket. The interface is used for service and diagnostic operations. You can connect your PC to the gateway via this interface. Additional information see chapter 6.3.

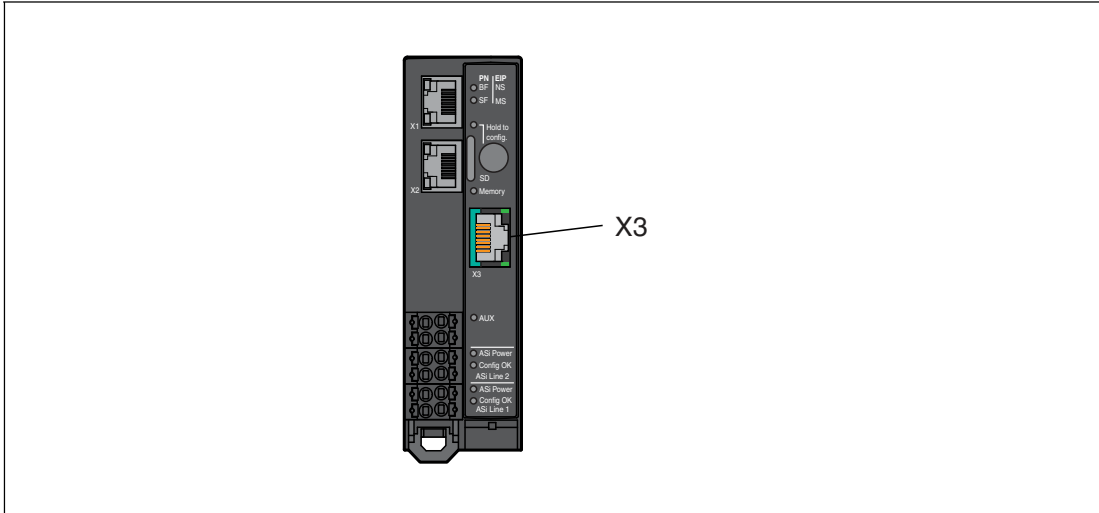

Figure 4.5

4.1.5 Micro SD Card

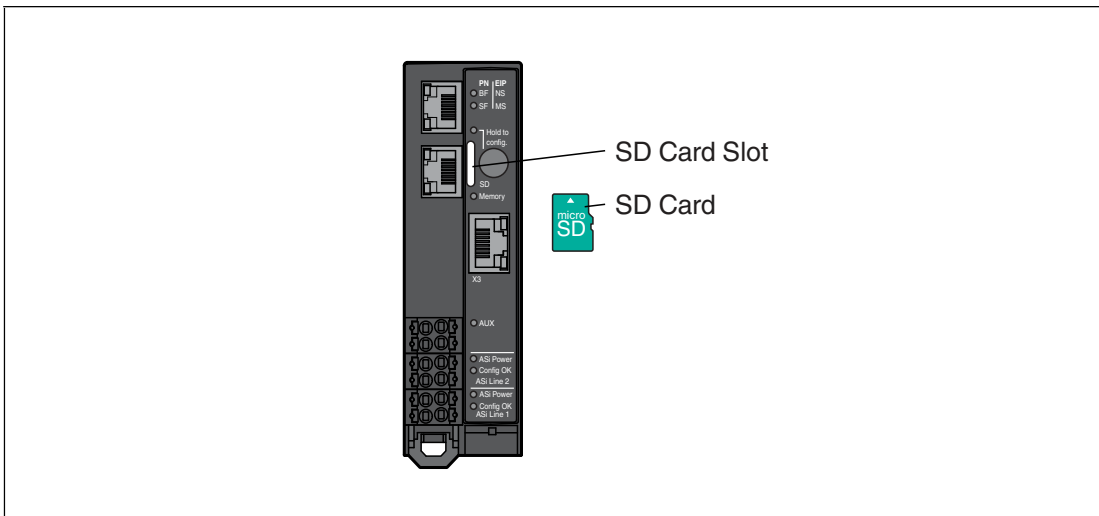

Figure 4.6

The configuration is automatically stored on an inserted micro SD card and can be overwritten if necessary. For more information on use, see chapter 6.2.4.5.



Note

The device can be operated without a micro SD card.



Warning!

Data Loss

The micro SD card must only be inserted and removed in a de-energized state.

The micro SD card must not be removed when the memory LED is flashing, otherwise data on the micro SD card may be lost.

Specification

- Format: microSD, 11 mm x 15 mm x 1 mm
- Type: SD, SDHC, SDXC
- Supply voltage: 3.3 V
- Speed modes used: SDR12, SDR25

We recommend using the Pepperl+Fuchs MICRO-SD-CARD-KINGSTON. You can find this SD card on our website at pepperl-fuchs.com.

Configuration via Micro SD Card

The micro SD card must be formatted in the "FAT32" file format. You can format the micro SD card using the web interface.

The gateway automatically stores its configuration data on an empty inserted micro SD card and updates it if necessary. If the device is replaced, the SD card can be removed from the old gateway and inserted into the new gateway. A gateway without configuration data automatically adopts valid configuration data from an inserted micro SD card as the target configuration.



Note

If the configuration data on the micro SD card and the gateway do not match, the "Memory" LED lights up red. The configuration data is not copied automatically. You can resolve the conflict in the web interface.

A micro SD card is not included in the scope of delivery for the gateway.



Inserting and Removing a Micro SD Card

1. Inserting the card:

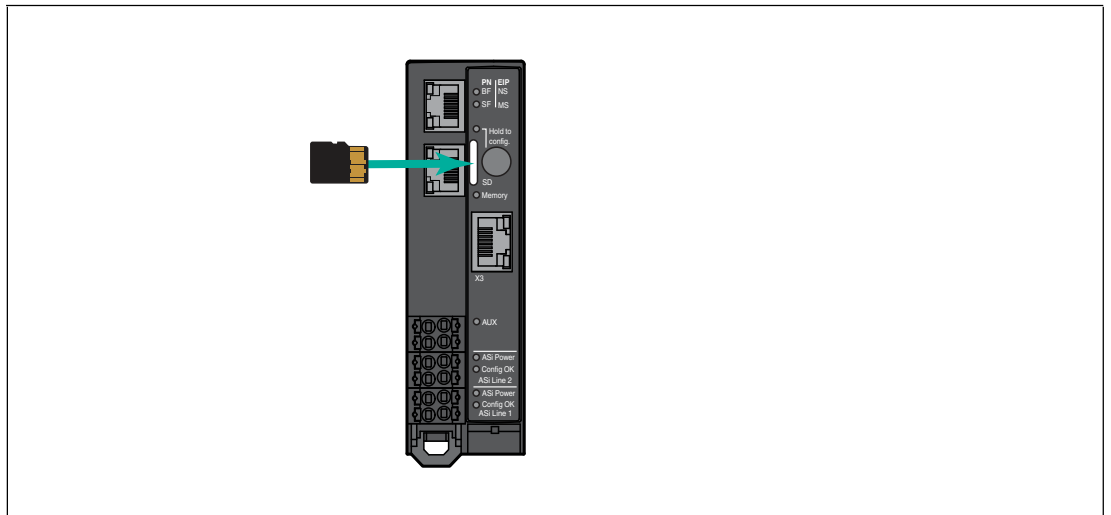

Figure 4.7

1. With the contacts facing up, slide the micro SD card into the SD card slot until it engages. The contacts should be facing the button.
2. **Removing the card:**
3. Push the inserted card into the SD card slot.
 - ↳ The release mechanism pushes the card out of the card slot.
 - ↳ You can then carefully remove the card.



Caution!

File System Corruption

Do not remove the micro SD card while the "Memory" LED lights up yellow to indicate an active write operation. Otherwise, the file system of the gateway may be corrupted.

See chapter 3.2.

4.2 Mounting and Dismounting

- Mount the gateway in the switch cabinet.
- Mount the gateway on a 35 mm DIN rail in accordance with DIN/EN 50022.

Heat Dissipation

The gateway has ventilation slots on the top and bottom of the enclosure. When the enclosure is properly installed, these ventilation slots allow air to circulate, which cools the inside of the device.

To allow air to circulate, observe the following conditions:

- Place the device vertically in the switch cabinet. Cold air is supplied from below and warm air can escape from above.
- Observe the minimum upper and lower distances; see figure.
- You can mount several devices side by side; see figure.



Warning!

Overheating

Do not close the ventilation slots. Do not cover the ventilation slots.

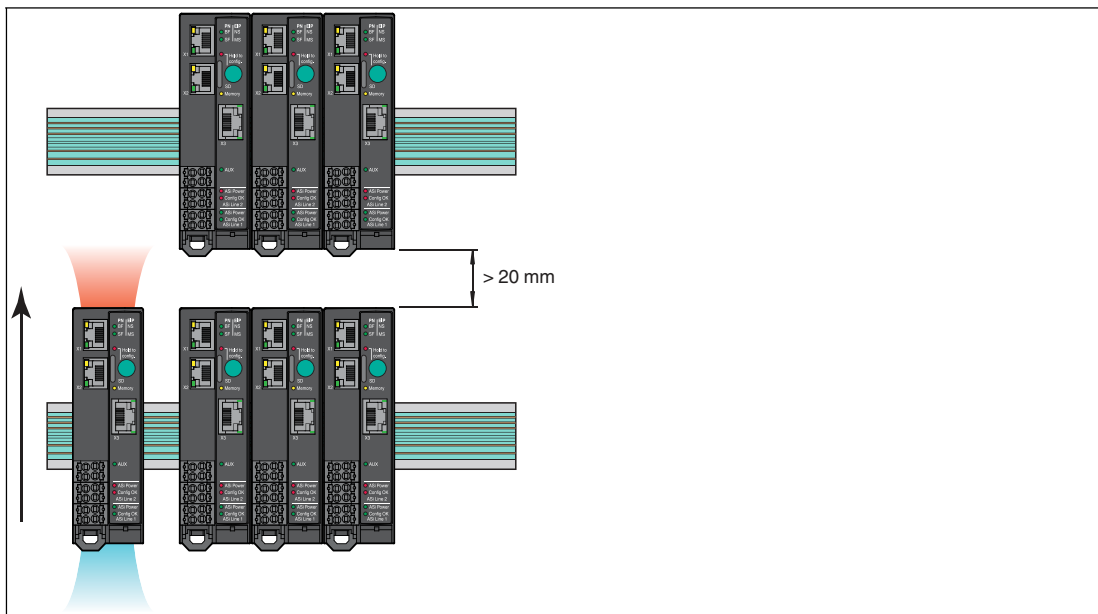

Figure 4.8 Minimum distances



Caution!

Ambient conditions

Observe the following conditions when mounting the device:

Pollution degree 2, max. height 5000 m ASL, max. humidity 95 %, without condensation.

Only use the device indoors.

To protect the device from mechanical hazards, fire hazards, or electrical hazards, place it in an external enclosure or in a switch cabinet.



Caution!

Damage to the gateway

Always cover the gateway when drilling above the device. To prevent a short circuit, do not allow metal chips or other particles to enter the enclosure through the ventilation openings.



Mounting in the Switch Cabinet

1. Place the gateway on the top edge of the DIN mounting rail.
2. Press the gateway on the bottom edge of the DIN mounting rail.

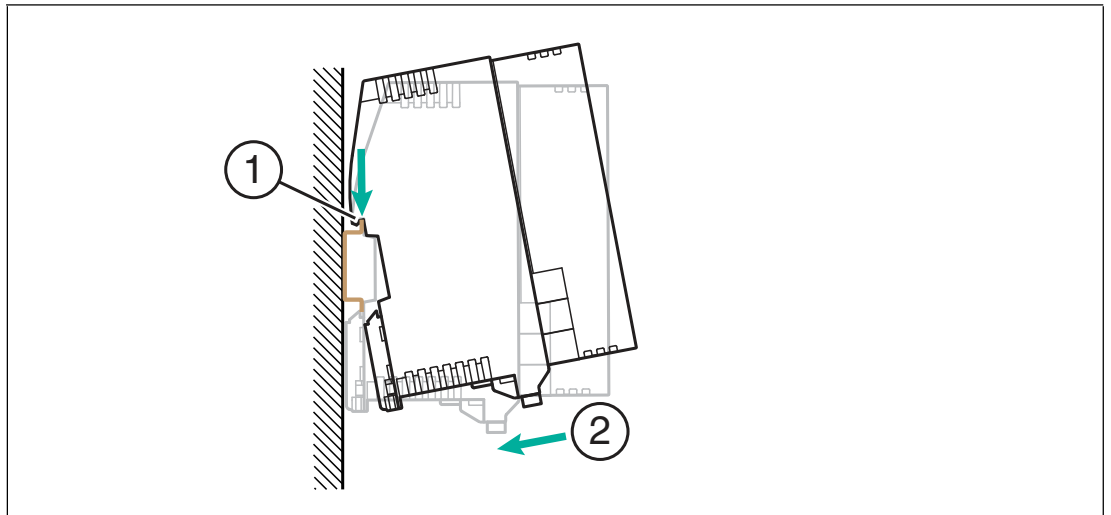

Figure 4.9

↳ The gateway snaps onto the DIN mounting rail.



Dismounting

1. Insert a screwdriver into the retaining clip (1) on the bottom edge.

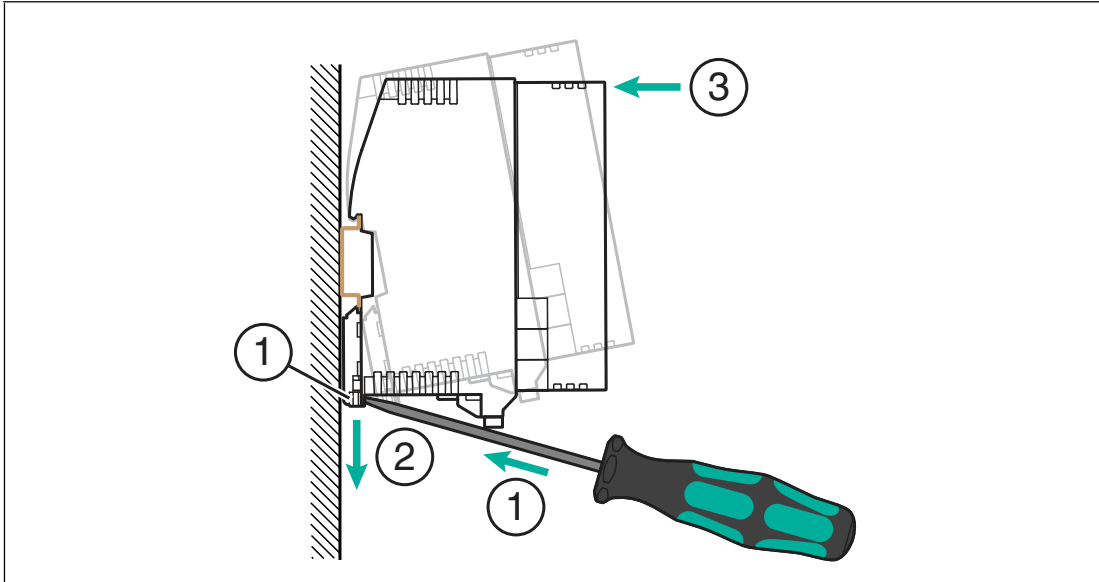

Figure 4.10

2. Push down on the retaining clip with the screwdriver.
3. Press the top edge of the gateway against the DIN mounting rail.
↳ Remove the gateway from the front.

5 Commissioning

5.1 Addressing the AS-Interface

Each AS-Interface node requires a unique address for unique identification in the AS-Interface network. This address can be assigned differently.



Note

Make sure that each AS-Interface node has a unique AS-Interface address. Assigning multiple nodes to a single AS-Interface address causes the relevant AS-Interface network to malfunction.

Make sure that no AS-Interface node uses the address 0.

You can address the AS-Interface node with the VBP-HH1-V3.0-KIT AS-Interface handheld programming device.

5.2 PROFINET



Note

The gateway starts in PROFINET mode when it is delivered. You can identify the current mode by the SF LED.

5.2.1 Preparation

GSDML file

The prerequisite for commissioning is an installed GSDML for this gateway.

You can download this file from our website at <https://www.pepperl-fuchs.com>.

MAC Addresses

The MAC address at the Ethernet level is used to uniquely identify the gateway. This address is unique and cannot be changed by the user. The MAC address is printed on the module.

Example

The configuration is described using the example of the gateway for two VBG-EP1-KE5-DMD AS-Interface networks. For the gateway for a VBG-EP1-KE5-D AS-Interface network, the configuration is carried out with some minor differences, e.g., differences in labeling.

5.2.1.1 Configuration



Note

The configuration and commissioning process for the modules described over the following pages was performed using the TIA Portal V 14 engineering software from SIEMENS. When using a programmable logic controller from a different controller provider, please refer to the corresponding documentation.



Integration of the Gateway in the TIA Portal

1. Install the GSDML file for the required gateway in the TIA Portal.
A GSDML file is available for block mapping. With block mapping, the digital data of the AS-Interface nodes is transferred to the PLC in its entirety in one data field as a block. Areas with a non-existent AS-Interface node address are filled with zeros.

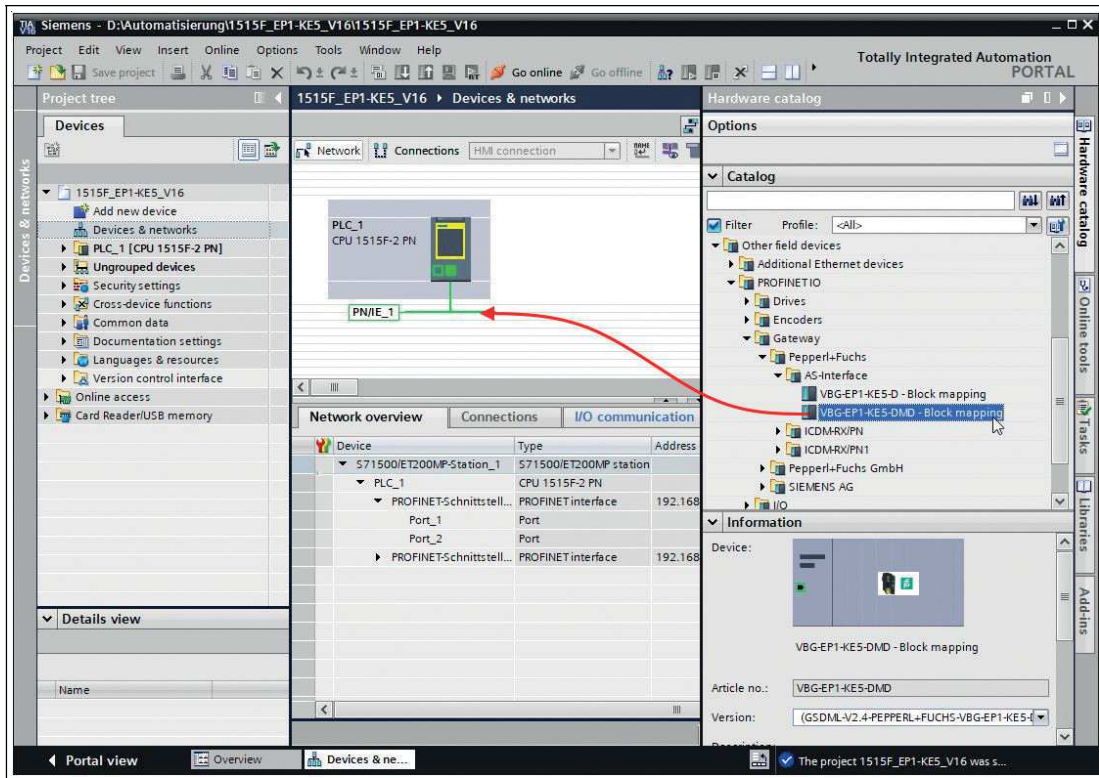

Figure 5.1 Hardware catalog

2. Select the new device in the hardware catalog. Add the device to the PROFINET connection.
3. Select the appropriate PROFINET controller.
4. Select the Ethernet port with the right mouse button and enable the properties. Assign a suitable IP address and the PROFINET device name.

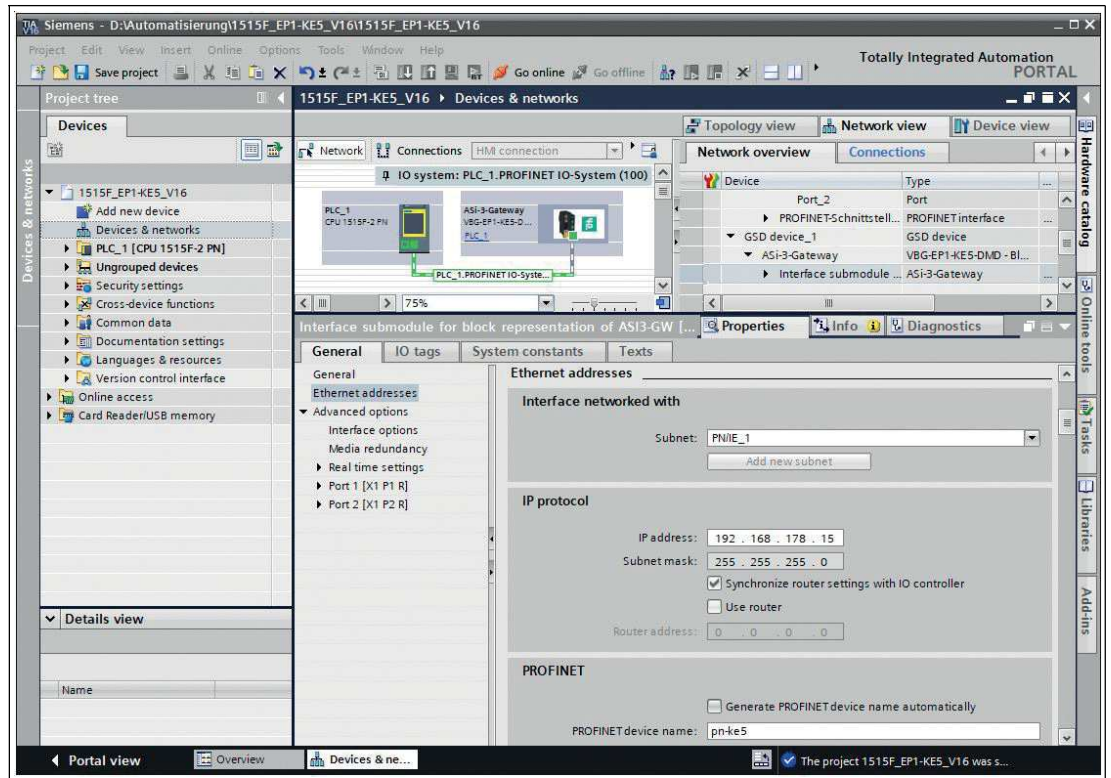

Figure 5.2 Ethernet properties



Note

The assignment of unique PROFINET device names is absolutely necessary for the internal organization of the PROFINET network.

5.2.1.2 Online Assignment of the Device Name

Each module must have a device name so that each node in the PROFINET network can be assigned an IP address. A node search displays all PROFINET devices that have been found. The MAC address at the Ethernet level is used to uniquely identify the gateway. This is unique and cannot be changed by the user. The MAC address is printed on the module. Using the MAC address, each device can be found in the list of available nodes and assigned a device name.



Assigning Device Names

1. Connect the gateway to the PROFINET network.
2. Open the dialog Accessible devices dialog via the main menu "Online -> Accessible devices ..."

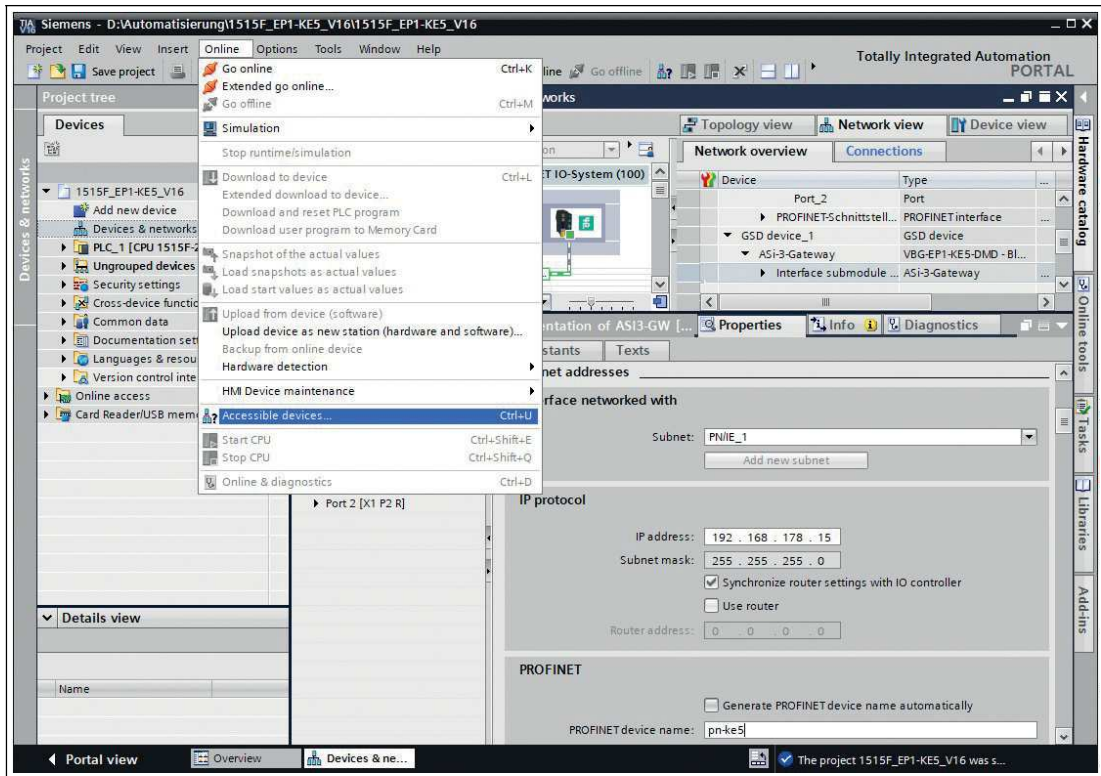

Figure 5.3

3. Select the new gateway based on the MAC addresses. Typically, the IP address 0.0.0.0 or the MAC address will be shown.

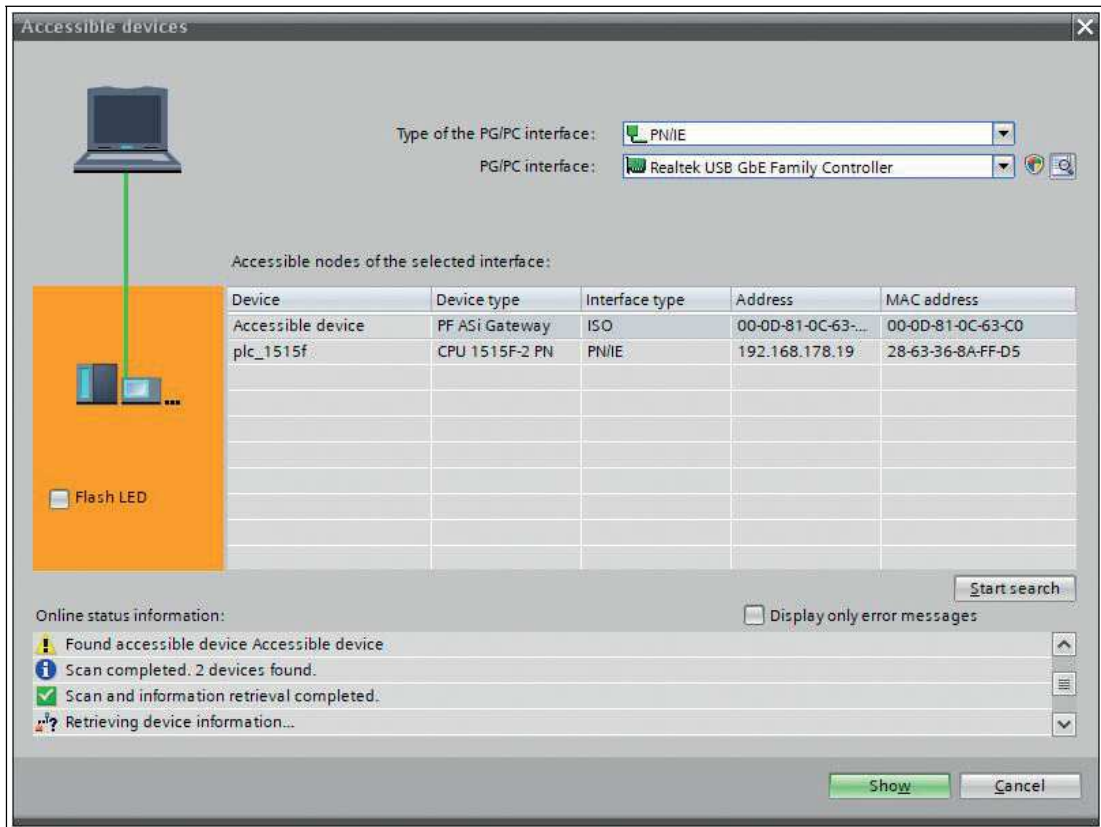

Figure 5.4

4. Click on the "Show" button.



Tip

If the gateway does not appear in the list of accessible devices on the network, check your firewall settings.

5. Assign the selected PROFINET device name to the gateway.

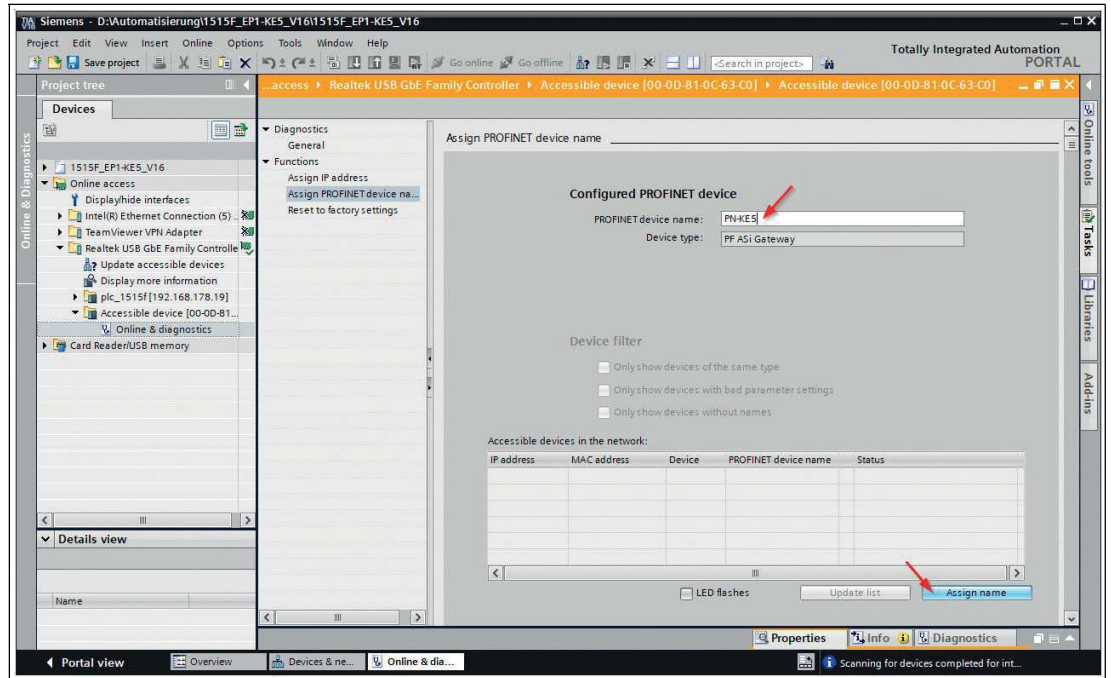

Figure 5.5

6. Press the "Assign name" button
 ↳ The status reports the successfully assigned name.

5.2.1.3 Factory Reset



Factory Reset

1. Connect the gateway to the PROFINET network.
2. Open the Accessible Nodes dialog via the main menu "Online -> Accessible nodes..."

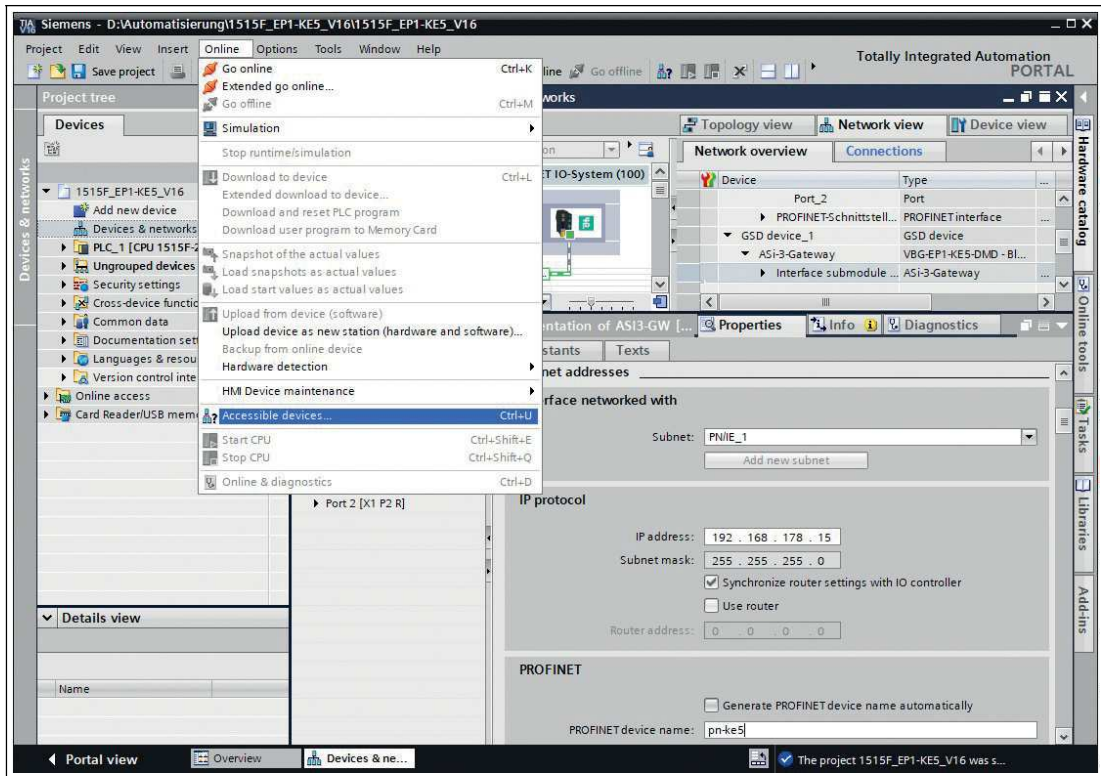

Figure 5.6

3. Select the gateway you want to reset.

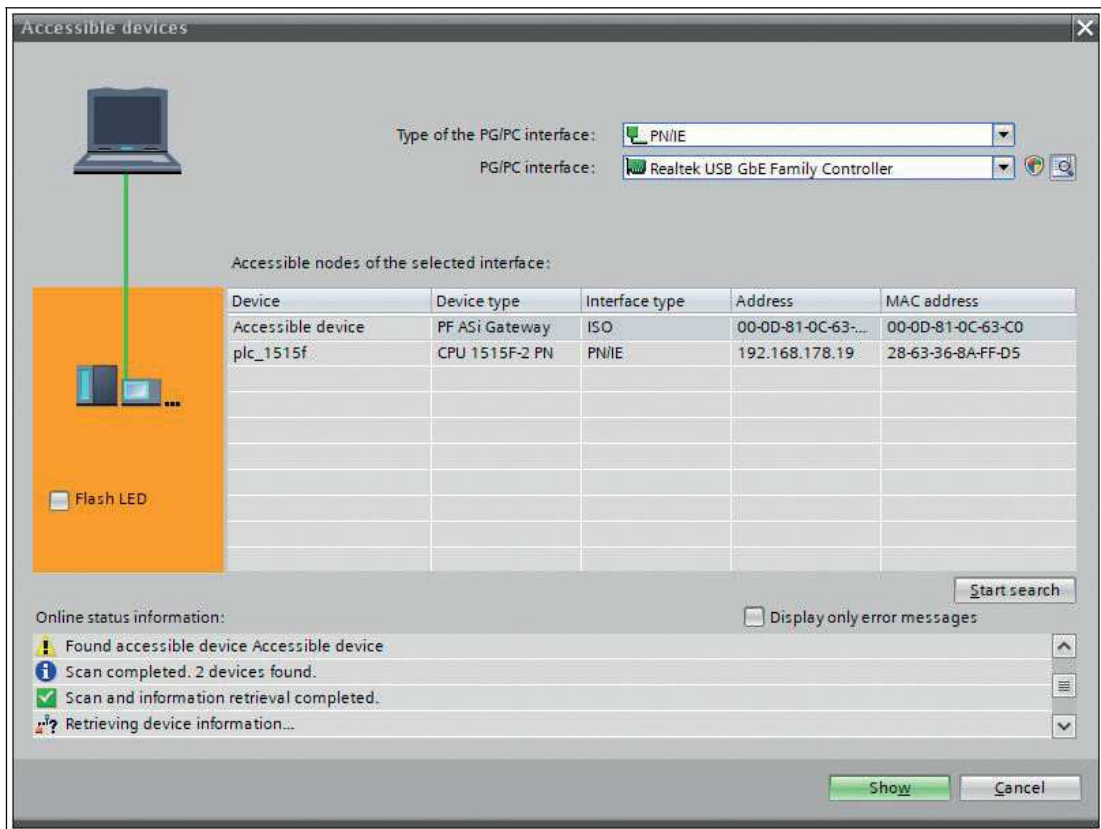

Figure 5.7

4. Click on the "Show" button.



Tip

If the gateway does not appear in the list of accessible nodes on the network, check your firewall settings.

5. Open the "Reset to factory settings" sub-menu.
6. Select whether the I&M data should be deleted or retained.
7. Click the "Reset" button and confirm the reset.

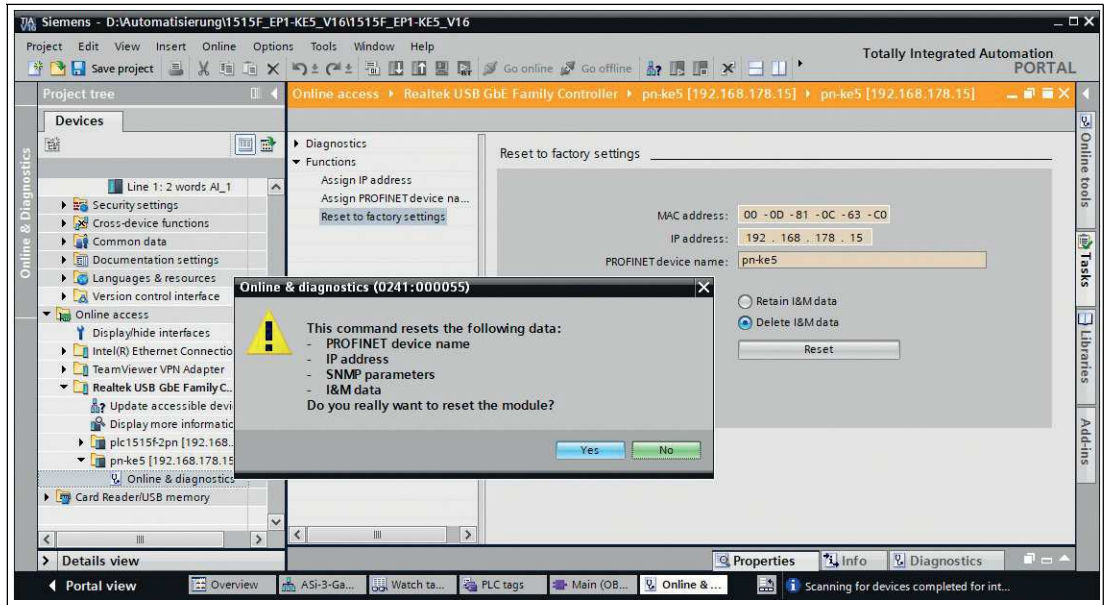

Figure 5.8

↳ The gateway is reset.

5.2.1.4 Configuration of the Gateway Slots

Go to the device overview of the gateway.

Depending on the ASi nodes used and the required functions, different modules can be selected from the hardware catalog and added to the gateway configuration

The following modules are available:

- Digital data
- Analog data
- Command interface
- Diagnostic modules
- Gateway record module

For a detailed description of the function of these modules, see chapter 5.2.2.

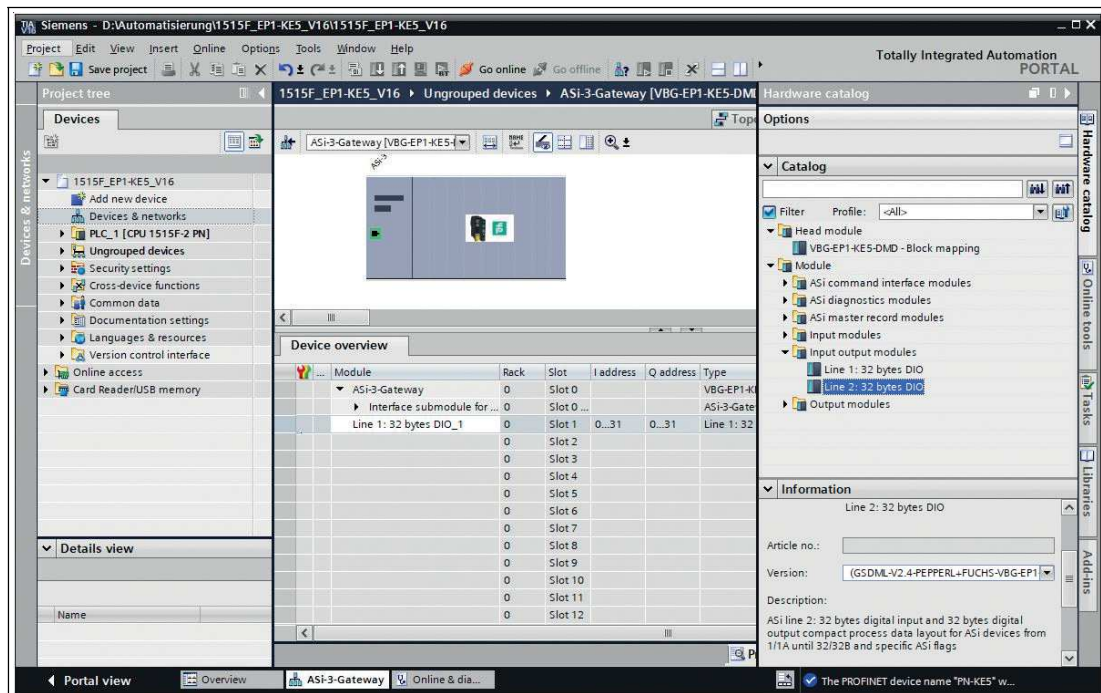

Figure 5.9

Select at least one of the available modules and add it to any slot.

Note

You may have to set module parameters depending on which information module is used.



Setting the Start-Up Parameters

1. Open the properties of the "Slot 0" slot.
2. Go to the module parameters.

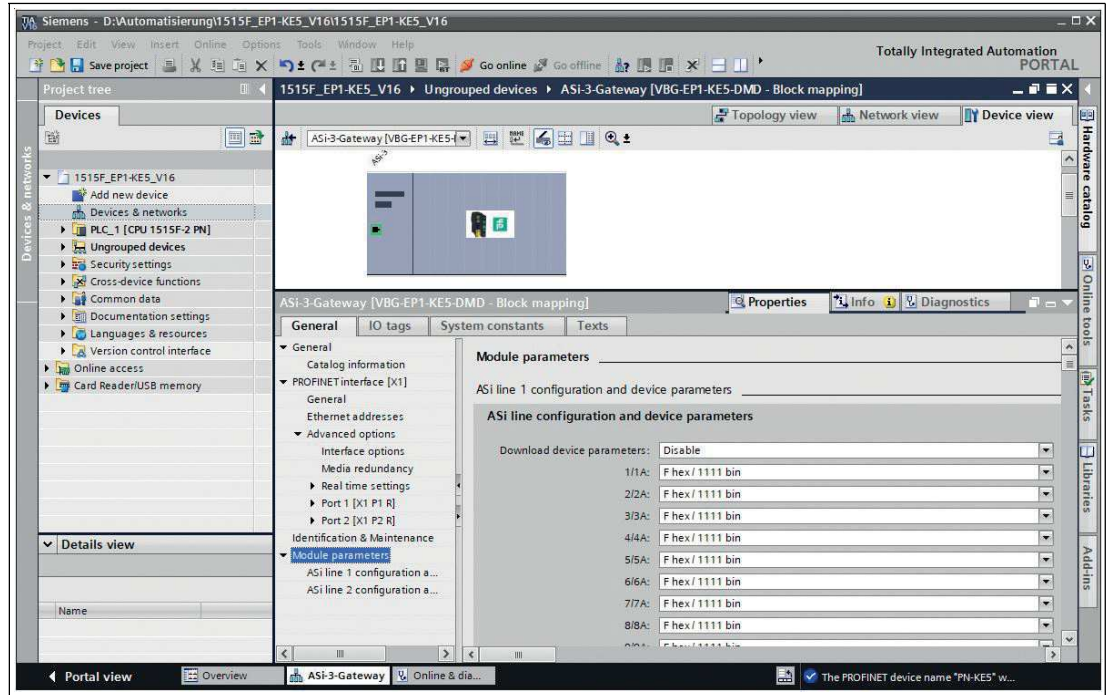

Figure 5.10

3. You can set the start-up parameters of the available AS-Interface nodes in this window.

5.2.1.5 Device Replacement Without Exchangeable Medium/Programming Units

PROFINET IO devices that support the "Device replacement without exchangeable medium or programming unit" function can be replaced by identical devices in an existing PROFINET network. In such cases, the IO controller assigns the device name. To do so, it uses the configured topology and the neighborhoods determined by the IO devices. The AS-Interface gateways from Pepperl+Fuchs support the function for replacing devices without an exchangeable medium or programming unit.



Device Replacement

1. Switch to the "Topology view" tab in the Editor. In the "Topology overview" table, "Any partner" is generally permitted as the partner port for each port.
2. Establish a connection between the appropriate Ethernet ports.

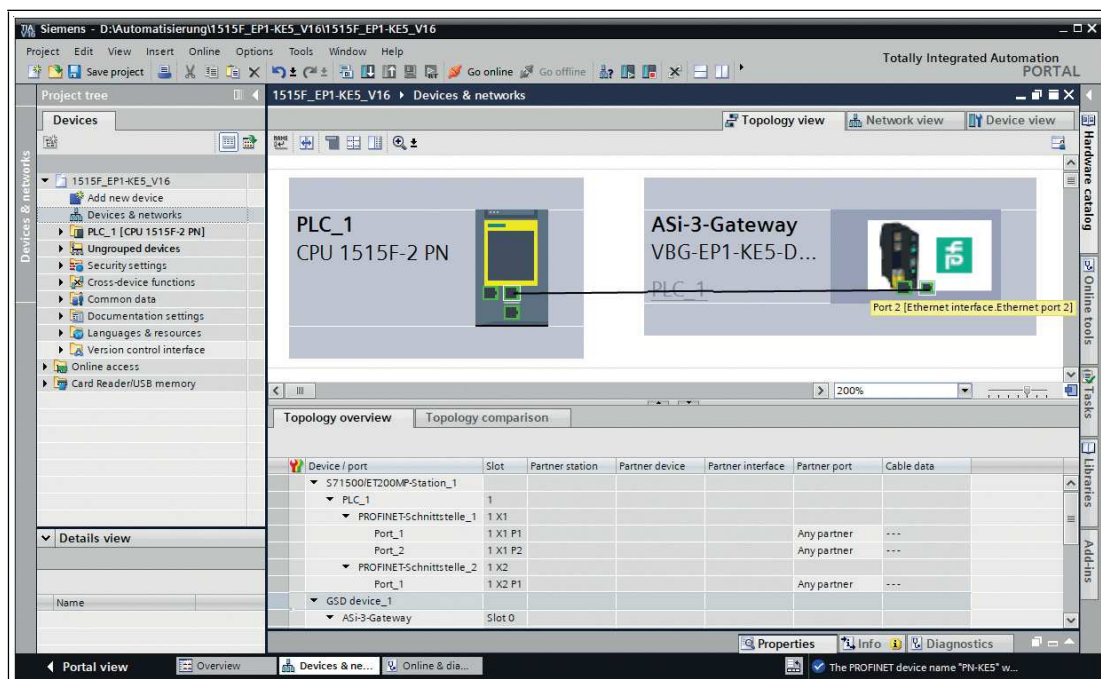

Figure 5.11

↳ The port connection was successful if the corresponding port names are displayed in the "Topology overview" under "Partner port."

3. Select the PROFINET IO controller and open the Properties.
4. Check whether the check box for "Support device replacement without exchangeable medium" is selected.



Note

If you also want to use the automatic assignment of the IP address and device name for preconfigured PROFINET devices, select the check box for "Permit overwriting of device names of all assigned IO devices."

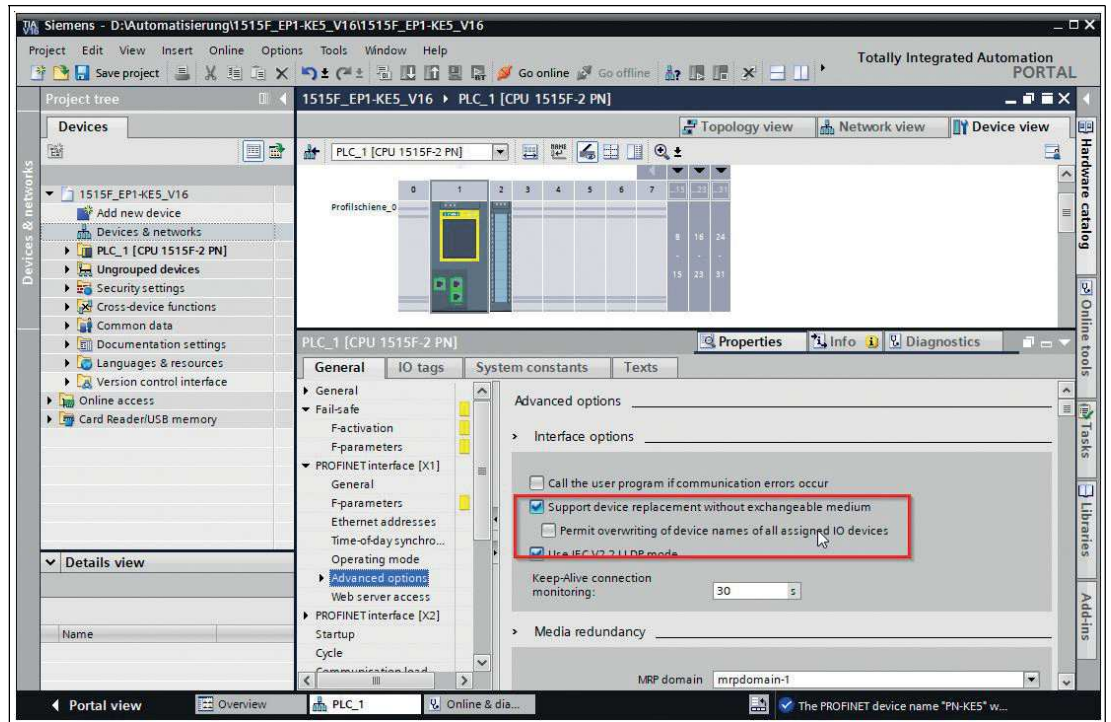

Figure 5.12



Note

A network topology is configured based on the connections between PROFINET ports on the individual devices. This can be reached via the "Port 0" slot of the PROFINET devices in use. Displaying all non-linked ports allows you to specify a suitable partner port in each case.

5.2.1.6

Watch and Force Tables

You can use watch and force tables to display and influence the status of process data.

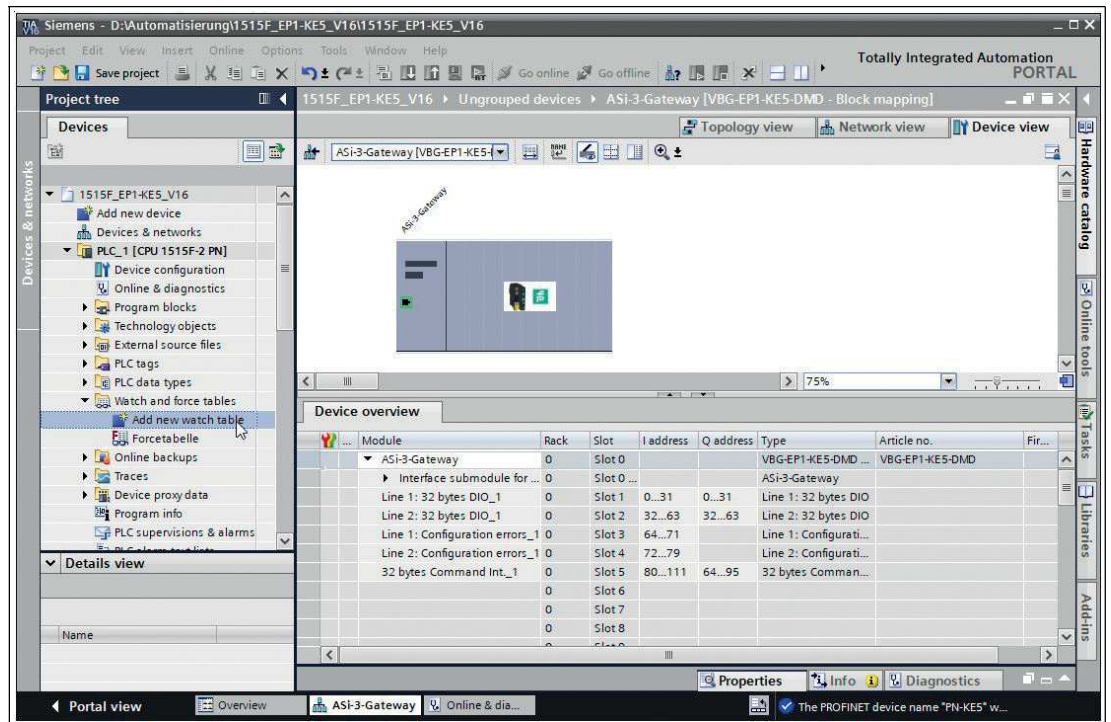

Figure 5.13



Note

The digital process data are assigned to bytes; see chapter 5.2.2.1. Enter the corresponding byte for the process data that you want to display in the watch tables.



Displaying Process Data

1. Assign variables to the process data that describe the content in a meaningful way.

↳ The names of the variables appear in the watch table:

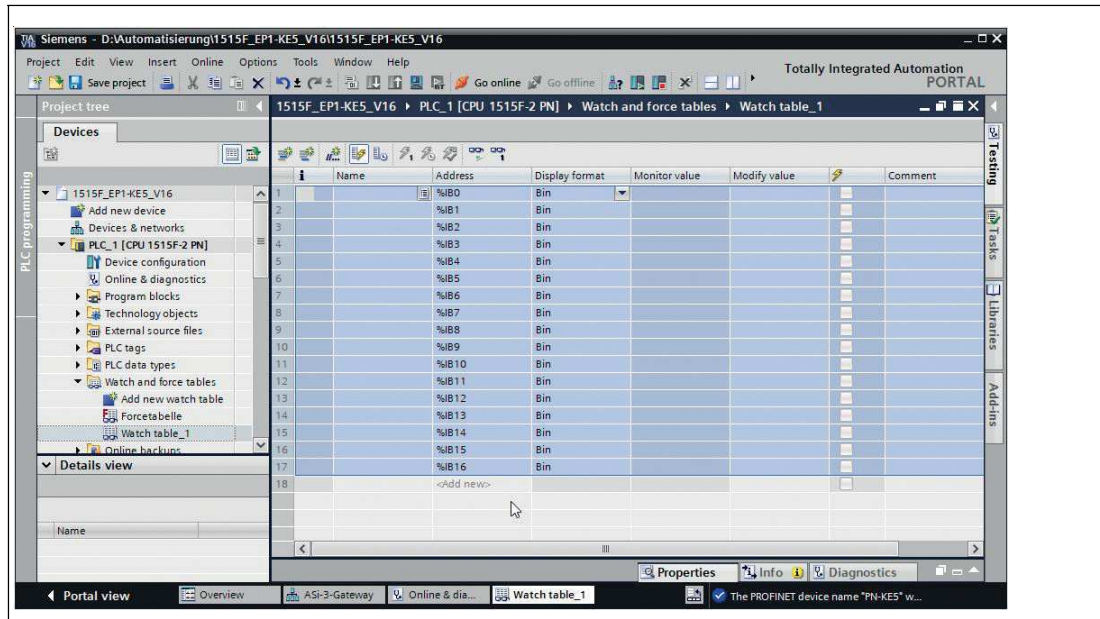

Figure 5.14

Once you have created the watch table, you can transfer this data to the PLC. The data is checked for consistency by the PLC and compiled.



Transferring Data to the PLC

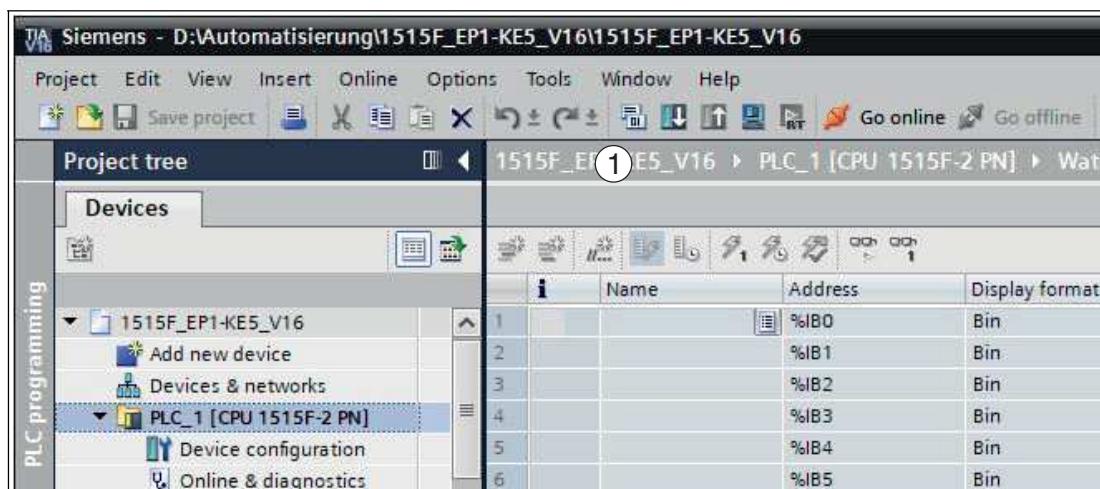

Figure 5.15

1. Click the "Download to device" symbol (1).

↳ The "Enhanced download to device" window opens. This window contains the connections with device names that are defined in the PROFINET network. See chapter 5.2.1.2.

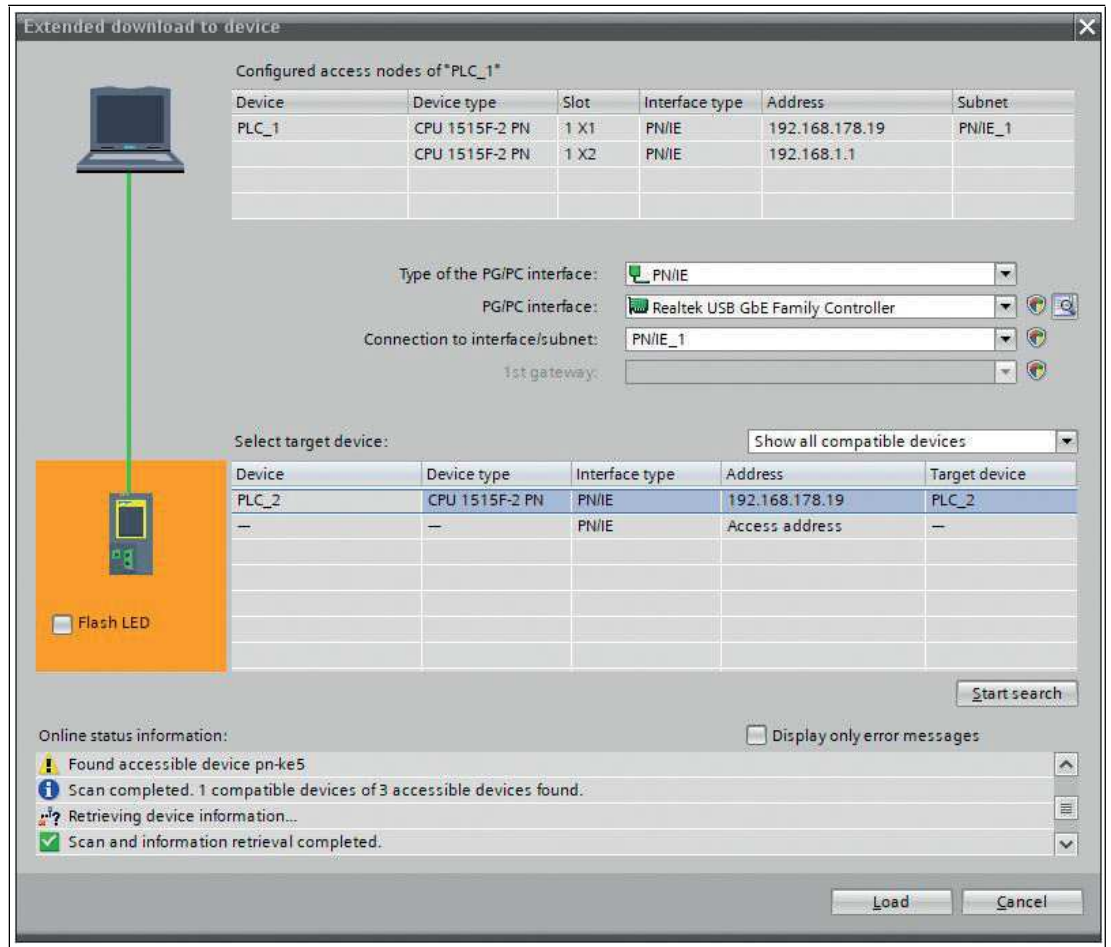

Figure 5.16

2. Select the PLC.
3. Press the "Load" button.

↳ The "Load preview" window is displayed.

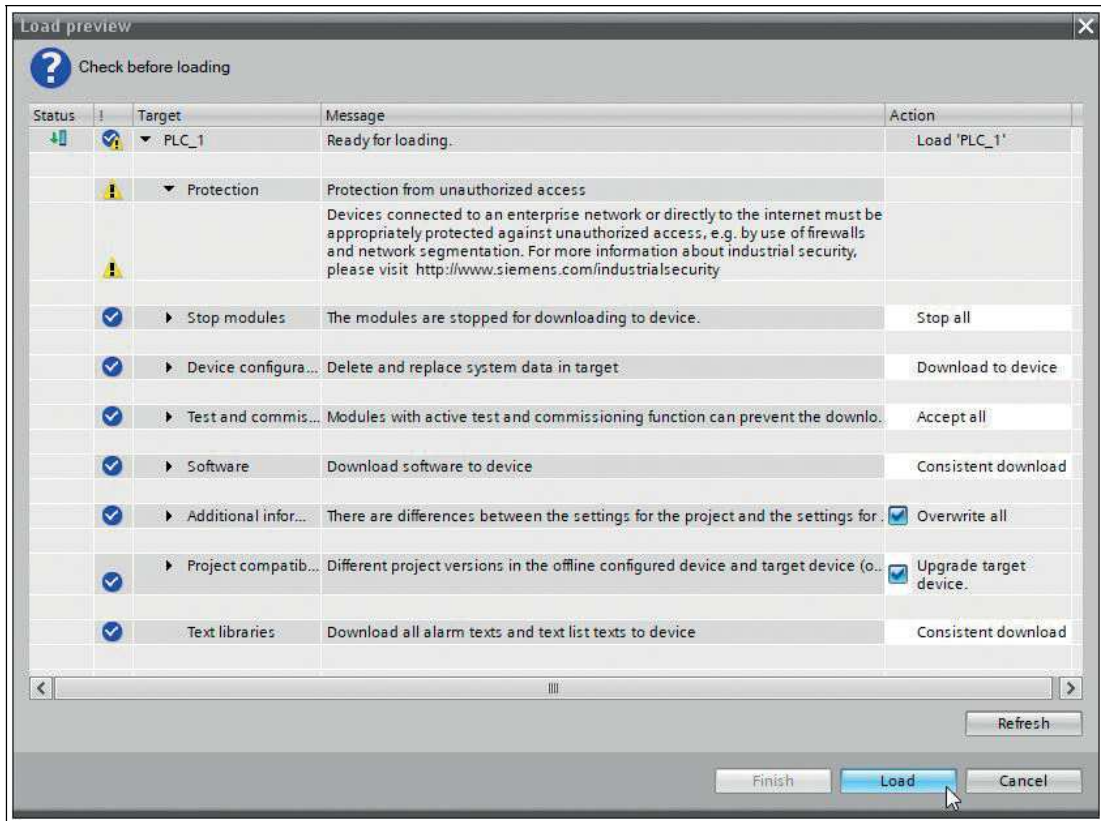

Figure 5.17



Note

In the download dialog, the PLC sets itself to the "Stop" operating state if another operating state is set.

4. Press the "Load" button.

↳ An event log of the loading process is displayed.

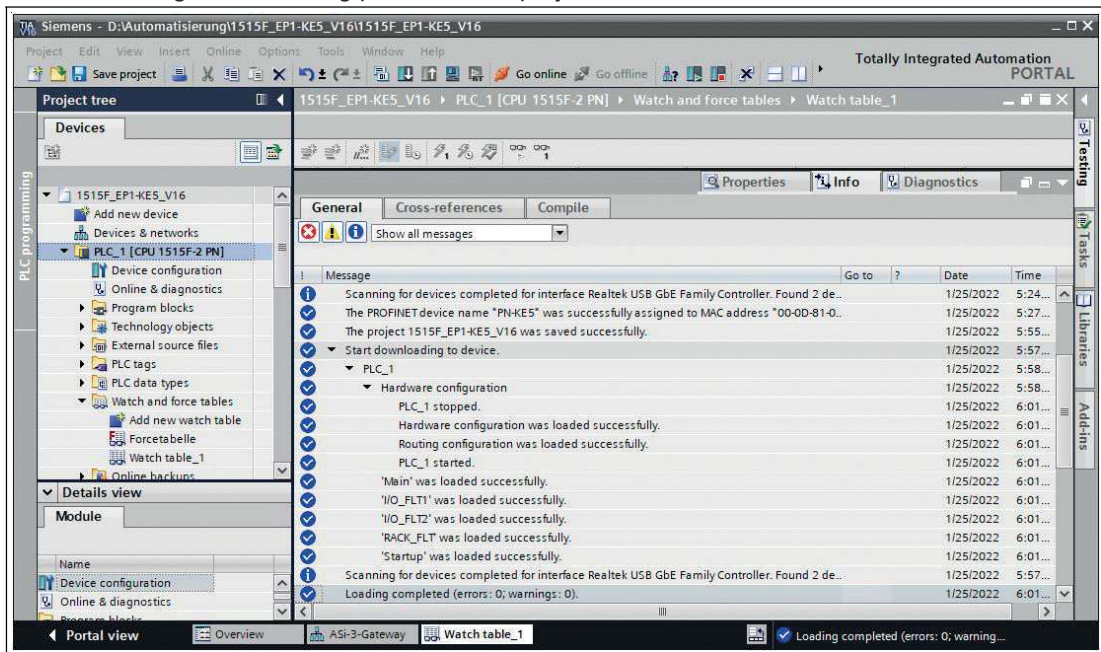

Figure 5.18

2023-06



Opening a Watch Table

1. Switch to the "Watch and force tables" tab.

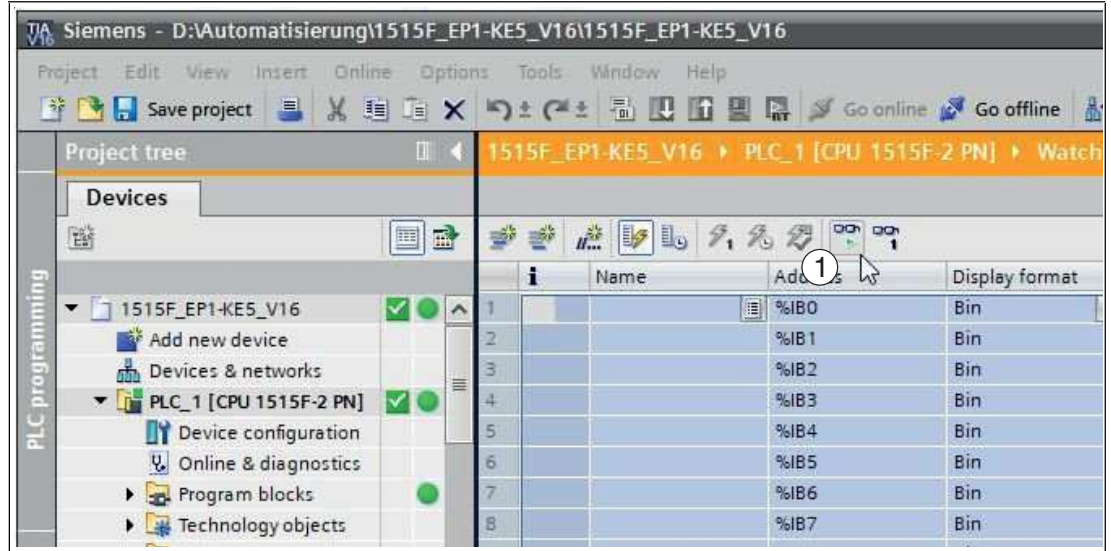

Figure 5.19

2. Click the "Watch all" symbol (1).

↳ The watch table opens.

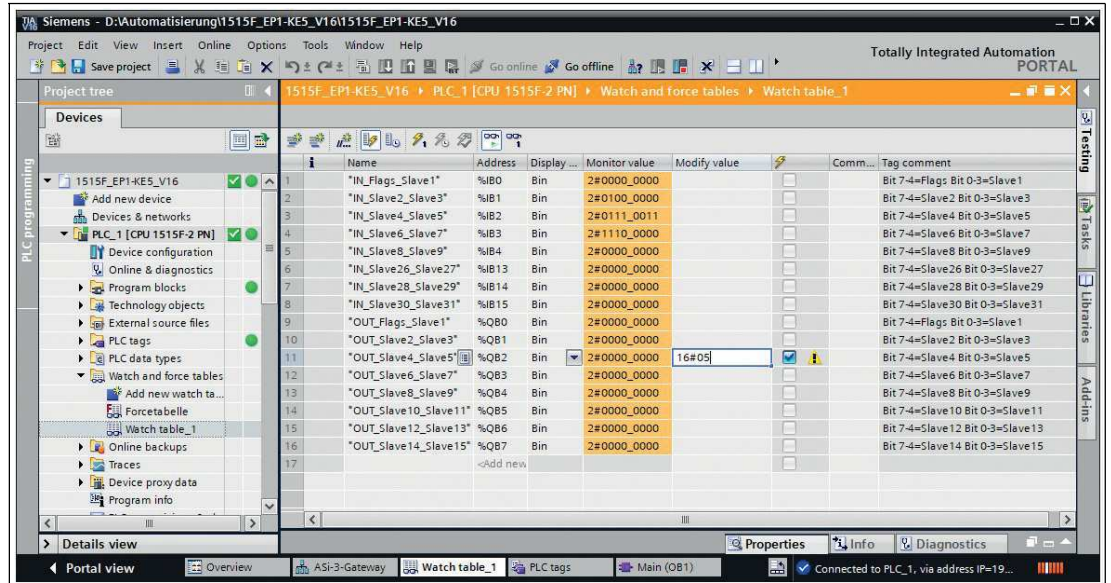

Figure 5.20



Controlling Outputs

You can use the modify value to influence outputs listed in the tables.

1. Enter a value in the "Modify value" column.

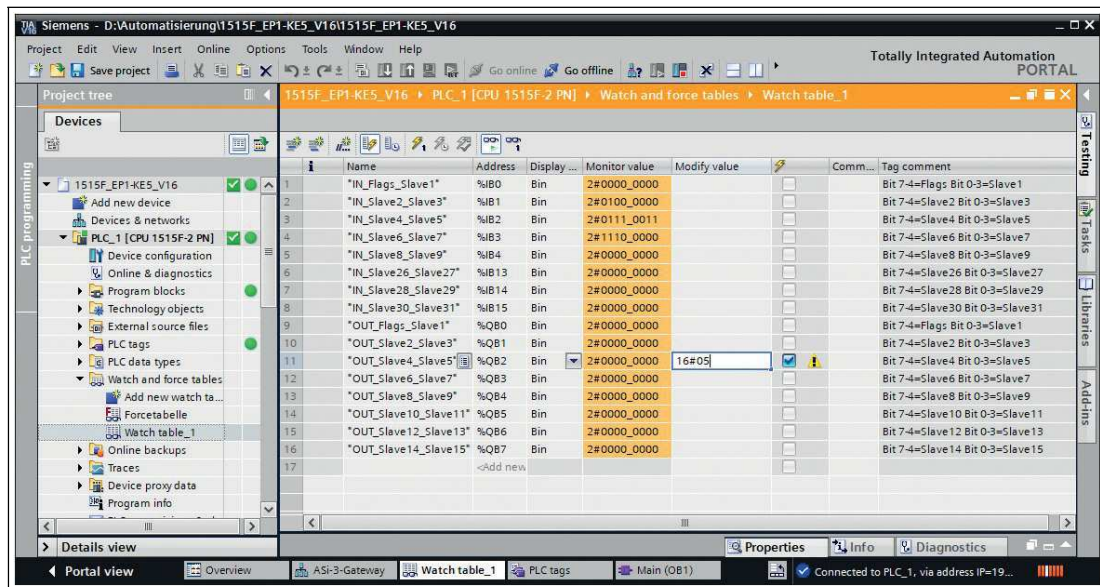

Figure 5.21

2. Activate the modify value with the key combination "Shift+F9."



Tip

Analog Values and Error Lists

In the watch table, you can watch analog values and error lists for appropriately configured nodes.

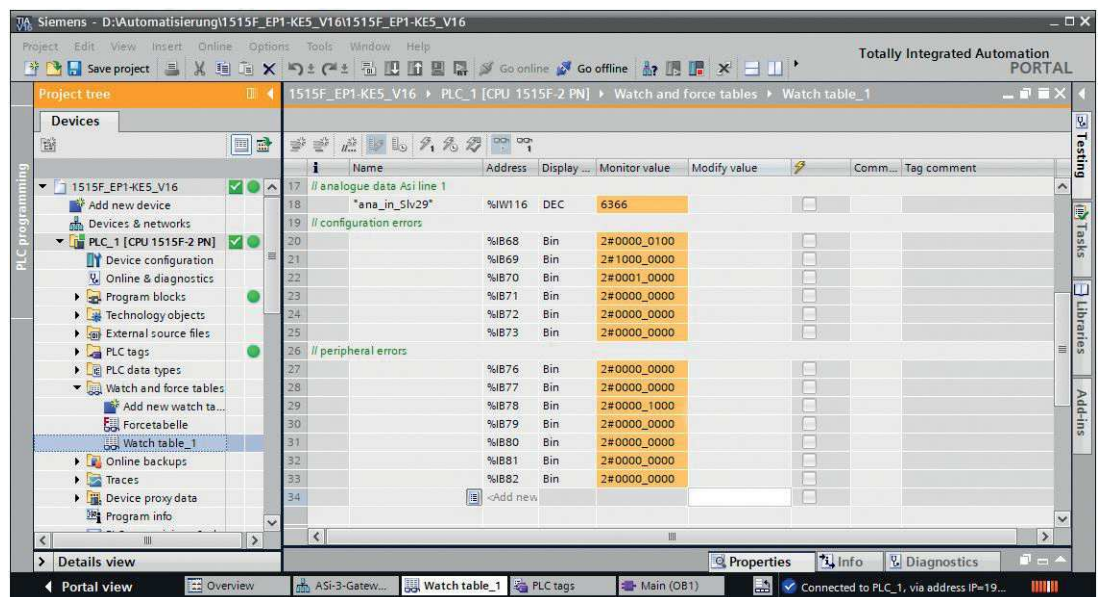

Figure 5.22

5.2.2 Modules

You can use the modules from the GSDML file to configure the gateway for the transfer of various process data. Below is a description of all the modules available in the GSDML file.



Note

The following representations show the default settings of the respective modules.

Use the one-segment module for the VBG-EP1-KE5-D and the two-segment modules for the VBG-EP1-KE5-DMD.

In the case of VBG-EP1-KE5-D, there is no reference to segment 1 or segment 2.

5.2.2.1 Digital Data

The gateway uses the digital data modules to transfer digital process data to the PLC.

You can find the following modules for configuring the gateway in the GSDML file.

Digital Input and Output Data

Module	Number of segments	Description
32 bytes DIO	1	32 bytes of digital input and output data for all single nodes, A nodes, and B nodes in segment 1
Line 1: 16 bytes DIO	2	16 bytes of digital input and output data for all nodes ¹ in segment 1
Line 2: 16 bytes DIO	2	16 bytes of digital input and output data for all nodes ¹ <Default → ¹ Font> in segment 2
Line 1: 32 bytes DIO	2	32 bytes of digital input and output data for all nodes in segment 1
Line 2: 32 bytes DIO	2	32 bytes of digital input and output data for all nodes in segment 2

Table 5.1

1. with a standard address or O address

Digital Input Data

Module	Number of segments	Description
32 bytes DI	1	32 bytes of digital input data for all single nodes, A nodes, and B nodes in segment 1
Line 1: 16 bytes DI	2	16 bytes of digital input data for all nodes ¹ <Default → ¹ Font> in segment 1
Line 2: 16 bytes DI	2	16 bytes of digital input data for all nodes ¹ <Default → ¹ Font> in segment 2
Line 1: 32 bytes DI	2	32 bytes of digital input data for all nodes in segment 1
Line 2: 32 bytes DI	2	32 bytes of digital input data for all nodes in segment 2

Table 5.2

Digital Output Data

Module	Number of segments	Description
32 bytes DO	1	32 bytes of digital output data for all single nodes, A nodes, and B nodes in segment 1
Line 1: 16 bytes DO	2	16 bytes of digital output data for all nodes ^{1<Default} Font> in segment 1
Line 2: 16 bytes DO	2	16 bytes of digital output data for all nodes ^{1<Default} Font> in segment 2
Line 1: 32 bytes DO	2	32 bytes of digital output data for all nodes in segment 1
Line 2: 32 bytes DO	2	32 bytes of digital output data for all nodes in segment 2

Table 5.3

Input Data

The data of address 0 is reserved for AS-Interface status messages to the gateway:

Error	Designation	Description
F0	Config Error	0 = Configuration OK 1 = Configuration error present
F1	ASi Power Fail	0 = AS-i voltage OK 1 = AS-i voltage missing / too low
F2	Peripheral Fault	0 = Peripherals OK 1 = Peripheral fault present
F3	Configuration Active	0 = Protected mode 1 = Configuration mode

Table 5.4

Output Data

F0 can be used by the PLC to put the gateway into offline mode:

Flag	Designation	Description
F0	Offline Mode flag	0 = Switches ASi gateway into online mode 1 = Switches ASi gateway into offline mode
F1	Reserved	-
F2	Reserved	-
F3	Reserved	-

Table 5.5

Assignment of AS-Interface / PROFINET in the 16-Byte Field

Byte	Bit 7	Bit 6	Bit 5	Bit 4	Bit 3	Bit 2	Bit 1	Bit 0
0	F3	F2	F1	F0	Node 1/1A			
1	Node 2/2A				Node 3/3A			
...			
15	Node 30/30A				Node 31/31A			

Table 5.6

Assignment of AS-Interface / PROFINET in the 32-Byte Field

Byte	Bit 7	Bit 6	Bit 5	Bit 4	Bit 3	Bit 2	Bit 1	Bit 0
0	F3	F2	F1	F0	Node 1/1A			
1	Node 2/2A				Node 3/3A			
...			
15	Node 30/30A				Node 31/31A			
16	Reserved				Node 1B			
17	Node 2B				Node 3B			
...			
31	Node 30B				Node 31B			

Table 5.7



Note

The actual memory address of the AS-Interface nodes is defined in the hardware configuration of the PLC.

5.2.2.2

Analog Data

The gateway uses the analog data module to transfer cyclic analog process data to the PLC.

You can configure the gateway for analog input or output data. The bandwidth of the data transfer can be adapted to the requirements of the analog modules present in the network.

Channel Settings

An AS-Interface analog module can transfer up to four channels with 16 bits (= 2 bytes) of data each. If not all four channels are used, the data transfer can be parameterized in such a way that only the channels actually used are transferred.

The data field size is defined by selecting the corresponding analog data module from the GSDML, e.g., "8 words AI" transfers 8 channels or 16 bytes of analog input data.

In the module parameters, the "Channel Filter" parameter can be used to select which channels and how many channels are transferred per node address.

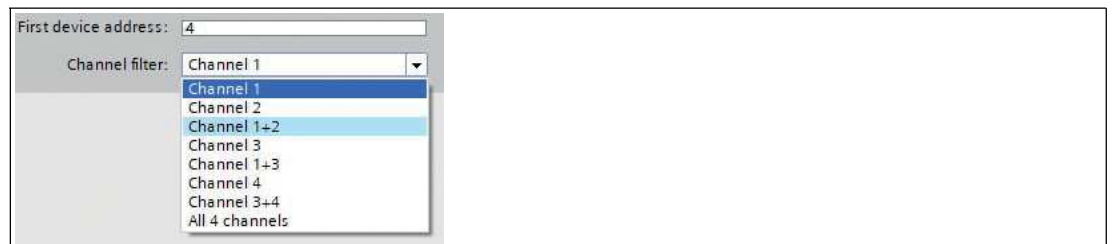

Figure 5.23 Channel Filter

The channel filter can be used to define how many channels each analog node can use. The amount of data for the individual settings is determined by the selected module.

- **Channel ***: 1 channel per consecutive node address
- **Channel *+***: 2 channels per consecutive node address
- **All 4 channels**: 4 channels per consecutive node address

The "First device address" field is used to specify the numerically first assigned AS-Interface address of the connected analog nodes.



Note

The connected analog nodes must have consecutive addresses to make meaningful use of the setting.

Analog Input Data

Module	Number of segments	Description
Modules for 2-channel (2 words) parameterizable analog input data:		
2 words AI	1	2-channel analog input data in segment 1
Line 1: 2 words AI	2	2-channel analog input data in segment 1
Line 2: 2 words AI	2	2-channel analog input data in segment 2
Modules for 4-channel (4 words) parameterizable analog input data:		
4 words AI	1	4-channel analog input data in segment 1
Line 1: 4 words AI	2	4-channel analog input data in segment 1
Line 2: 4 words AI	2	4-channel analog input data in segment 2
Modules for 8-channel (8 words) parameterizable analog input data:		
8 words AI		8-channel analog input data in segment 1
Line 1: 8 words AI		8-channel analog input data in segment 1
Line 2: 8 words AI		8-channel analog input data in segment 2

Table 5.8

Analog Output Data

Module	Number of segments	Description
Modules for 2-channel (2 words) parameterizable analog output data:		
2 words AO	1	2-channel analog output data in segment 1
Line 1: 2 words AO	2	2-channel analog output data in segment 1
Line 2: 2 words AO	2	2-channel analog output data in segment 2
Modules for 4-channel (4 words) parameterizable analog output data:		
4 words AO	1	4-channel analog output data in segment 1
Line 1: 4 words AO	2	4-channel analog output data in segment 1
Line 2: 4 words AO	2	4-channel analog output data in segment 2
Modules for 8-channel (8 words) parameterizable analog output data:		
8 words AO		8-channel analog output data in segment 1
Line 1: 8 words AO		8-channel analog output data in segment 1
Line 2: 8 words AO		8-channel analog output data in segment 2

Table 5.9

Example

The AS-Interface address 4 is set as the "First device address." There are four analog nodes connected. The channels 1+2 are transferred to each of the node addresses 4 – 7. 4 bytes of data are transferred per analog node. The 8 words AI module transfers 16-byte data packets from the gateway to the PLC.

- The "Channel 1+2" channel filter is used to transfer analog data as a 16-byte data packet via channels 1 and 2 of node addresses 4 to 7.



Assignment of AS-Interface Analog Data / PROFINET in the 16-Byte Field

Channel Filter "Channel 1+2"

Byte	Bit 7	Bit 6	Bit 5	Bit 4	Bit 3	Bit 2	Bit 1	Bit 0
0	Node 4: 2 bytes of analog data, channel 1							
1								
2	Node 4: 2 bytes of analog data, channel 2							
3								
...	...							
12	Node 7: 2 bytes of analog data, channel 1							
13								
14	Node 7: 2 bytes of analog data, channel 2							
15								

Table 5.10

Channel Filter "Channel 1"

Byte	Bit 7	Bit 6	Bit 5	Bit 4	Bit 3	Bit 2	Bit 1	Bit 0
0	Node 4: 2 bytes of analog data, channel 1							
1								
2	Node 5: 2 bytes of analog data, channel 1							
3								
...	...							
12	Node 10: 2 bytes of analog data, channel 1							
13								
14	Node 11: 2 bytes of analog data, channel 1							
15								

Table 5.11



Note

For analog nodes with A/B addresses, the data is mapped in channels 1 and 2 for nodes with an A address, and in channels 3 and 4 for nodes with a B address.

5.2.2.3

AS-Interface Diagnostic Information

Flags + Fault Detector

The gateway provides a list of collective error messages for each AS-Interface segment with the "Flags + Fault Detector." In the error message, the bits indicate whether there is an error in the network.

Error Messages

Module	Number of segments	Description
flags + fault det.	1	Collective error messages in segment 1
Line 1: flags + fault det.	2	Collective error messages in segment 1

Module	Number of segments	Description
Line 2: flags + fault det.	2	Collective error messages in segment 2

Table 5.12

Assignment of AS-Interface/PROFINET in the 2-Byte Field

Byte	Bit 7	Bit 6	Bit 5	Bit 4	Bit 3	Bit 2	Bit 1	Bit 0
0	-	-	-	Earth fault	-	-	-	Peripheral fault
1	AS-Interface master offline	AS-Interface power fail	Not in normal operation	Configuration mode active	Auto address assignment not available	Auto address assignment not possible	LDS.0	Configuration error

Table 5.13

Error Messages

Designation	Description
Peripheral fault	0 = No activated node reports a peripheral fault 1 = At least one node reports a peripheral fault
Earth fault	0 = No short circuit to ground detected on the AS-Interface network 1 = Short circuit to ground detected on the AS-Interface network
Configuration error	0 = There is no configuration error 1 = At least one configuration error found
LDS.0	0 = No AS-Interface node with address 0 found 1 = AS-Interface node with address 0 is connected to the AS-Interface segment
Auto address assignment not possible	0 = The condition for automatic address assignment is currently met 1 = Automatic address assignment is currently not possible
Auto address assignment available	0 = Automatic address assignment is disabled 1 = The gateway performs an automatic address assignment as soon as the conditions for automatic addressing are met.
Configuration mode active	0 = AS-Interface gateway is in protected mode 1 = AS-Interface gateway is in configuration mode
Not in normal operation	0 = AS-Interface gateway is in the normal operating state 1 = AS-Interface gateway is not in the normal operating state (e.g., startup phase)
AS-Interface power fail	0 = AS-Interface segment voltage OK 1 = AS-Interface segment voltage too low or power failure during data transfer on the AS-Interface network
AS-Interface master offline	0 = AS-Interface gateway is online 1 = AS-Interface gateway is offline

Table 5.14

Configuration Errors

The gateway provides a list of configuration errors for each AS-Interface segment. The configuration errors indicate directly in the process data if a configuration error is present at a node address.

Error Messages

Module	Number of segments	Description
config. err.	1	Configuration error in segment 1
Line 1: config. err.	2	Configuration error in segment 1
Line 2: config. err.	2	Configuration error in segment 2

Table 5.15

Assignment of AS-Interface/PROFINET in the 8-Byte Field

Byte	Bit 7	Bit 6	Bit 5	Bit 4	Bit 3	Bit 2	Bit 1	Bit 0
0	7A/7	6A/6	5A/5	4A/4	3A/3	2A/2	1A/1	0
1	15A/15	14A/14	13A/13	12A/12	11A/11	10A/10	9A/9	8A/8
2	23A/23	22A/22	21A/21	20A/20	19A/19	18A/18	17A/17	16A/16
3	31A/31	30A/30	29A/29	28A/28	27A/27	26A/26	25A/25	24A/24
4	7B	6B	5B	4B	3B	2B	1B	0
5	15B	14B	13B	12B	11B	10B	9B	8B
6	23B	22B	21B	20B	19B	18B	17B	16B
7	31B	30B	29B	28B	27B	26B	25B	24B

Table 5.16

Bit Values

- 1 A configuration error is present. The configuration of the node does not match the expected configuration.
- 0 Configuration OK. The configuration of the node matches the expected configuration.

Peripheral Faults

The gateway provides a list of peripheral faults for each AS-Interface segment. The peripheral faults indicate directly in the process data if a peripheral fault is present at a node address.

Error Messages

Module	Number of segments	Description
peripheral fault	1	Peripheral fault in segment 1
Line 1: peripheral fault	2	Peripheral fault in segment 1
Line 2: peripheral fault	2	Peripheral fault in segment 2

Table 5.17

Assignment of AS-Interface/PROFINET in the 8-Byte Field

Byte	Bit 7	Bit 6	Bit 5	Bit 4	Bit 3	Bit 2	Bit 1	Bit 0
0	7A/7	6A/6	5A/5	4A/4	3A/3	2A/2	1A/1	0
1	15A/15	14A/14	13A/13	12A/12	11A/11	10A/10	9A/9	8A/8
2	23A/23	22A/22	21A/21	20A/20	19A/19	18A/18	17A/17	16A/16
3	31A/31	30A/30	29A/29	28A/28	27A/27	26A/26	25A/25	24A/24
4	7B	6B	5B	4B	3B	2B	1B	0
5	15B	14B	13B	12B	11B	10B	9B	8B
6	23B	22B	21B	20B	19B	18B	17B	16B
7	31B	30B	29B	28B	27B	26B	25B	24B

Table 5.18

Bit Values

- 1** The node is enabled and reports a peripheral fault
- 0** The node does not report a peripheral fault or the node is disabled

5.2.2.4 Command Interface

In addition to the cyclic data images, information from the gateway can be retrieved via the command interface. For this purpose, the Command Interface module from the GSDML file is integrated into the cyclic data exchange. The gateway is addressed by the PLC with special commands via the Command Interface module. The node receives parameters or responds with the requested data.

Module	Number of segments	Description
12 bytes Command Int.	-	12-byte command interface
32 bytes Command Int.	-	32-byte command interface

Table 5.19

Format of the Command Request

Byte	Bit 7	Bit 6	Bit 5	Bit 4	Bit 3	Bit 2	Bit 1	Bit 0
0	Command							
1	T	0	-	-	-	-	-	Segment
2	0		A/B	AS-Interface node address				
3	Byte 1 payload data							
...	Byte ... payload data							
n-1	Byte n-3 payload data							

Table 5.20

Note



The node address is only used when a specific node is addressed, otherwise "Byte 0 payload data" is used.

The "command / toggle bit" command request is included in the command response if the command has been revised by the AS-Interface gateway.

Format of the Command Response

Byte	Bit 7	Bit 6	Bit 5	Bit 4	Bit 3	Bit 2	Bit 1	Bit 0
0	Command ¹							
1	T	Error code						
2	Byte 0 payload data							
...	Byte ... payload data							
n-1	Byte n-3 payload data							

Table 5.21

1. Corresponds to the requested command

Description

- Command: 1-byte command value
- T = toggle bit:
 1. a response is valid if the toggle bit in the response has the same status as in the command.
 2. the bit must be inverted to resend the same command
- Segment: describes the AS-Interface segment that is controlled by the gateway
 - Segment = 0: AS-Interface segment 1
 - Segment = 1: AS-Interface segment 2
- A/B: node address is an A or B address
- AS-Interface node address: numeric node address
- Error code: a description of an error in the execution of the command, if applicable
- Payload data: command-specific; contains data specified by a command

Overview of Commands

The following 1-byte commands can be sent to the gateway via the command interface:

Designation	Value _{hex}	Reference
GET_PERMANENT_PARAMETER	0x01	See chapter 8.1
WRITE_PARAMETER	0x02	See chapter 8.2
READ_PARAMETER	0x03	See chapter 8.3
STORE_ACTUAL_PARAMETERS	0x04	See chapter 8.4
STORE_ACTUAL_CONFIGURATION	0x07	See chapter 8.5
SET_OFFLINE_MODE	0x0A	See chapter 8.6
SET_AUTO_ADDRESS_ENABLE	0x0B	See chapter 8.7
SET_OPERATION_MODE	0x0C	See chapter 8.8
CHANGE_SLAVE_ADDRESS	0x0D	See chapter 8.9
SET_PERMANENT_CONFIGURATION	0x25	See chapter 8.10
GET_PERMANENT_CONFIGURATION	0x26	See chapter 8.11
READ_ACTUAL_CONFIGURATION	0x28	See chapter 8.12
SET_LPS	0x29	See chapter 8.13
GET_LPF	0x3E	See chapter 8.14
WRITE_EXTENDED_ID_CODE_1	0x3F	See chapter 8.15
SET_PERMANENT_PARAMETER	0x43	See chapter 8.16
GET_LPS	0x44	See chapter 8.17
GET_LAS	0x45	See chapter 8.18

2023-06

Designation	Value _{hex}	Reference
GET_LDS	0x46	See chapter 8.19
GET_FLAGS	0x47	See chapter 8.20
SET_DATA_EXCHANGE_ACTIVE	0x48	See chapter 8.21
GET_DELTA_LIST	0x57	See chapter 8.22
WRITE_74_75_PARAMETER	0x5A	See chapter 8.23
READ_74_75_PARAM	0x5B	See chapter 8.24
READ_74_75_ID	0x5C	See chapter 8.25
READ_74_DIAG	0x5D	See chapter 8.26
TRANSFER_75	0x5E	See chapter 8.27
GET_LCS	0x60	See chapter 8.28
GET_AUTO_ADDRESS_ENABLE	0xE1	See chapter 8.29
SET_MOTOR_CONTROL_CONFIG	0xE2	See chapter 8.30

Table 5.22

Command Response Error Codes

The following error codes occur when a command execution fails.

Error Codes

Designation	Value	Description
0x44	0xC4	Node not available
0x47	0xC7	Data volume larger than mailbox size
OK	0x00	Error-free execution
HI_NG	0x11	General fault
HI_OPCODE	0x12	Impermissible value in the command
HI_LENGTH	0x13	The length of the command interface is too short
HI_ACCESS	0x14	No access permission Command not allowed due to operating mode
EC_NG	0x21	General fault
EC_SND	0x22	Node not detected at the specified source address
EC_SD0	0x23	Node detected at address 0
EC_SD2	0x24	Node not detected at the specified target address
EC_DE	0x25	Error during deletion
EC_SE	0x26	Error during writing
EC_AT	0x27	Temporary address
EC_ET	0x28	Temporary ID1 code
EC_RE	0x29	ID1 code read error
Unsupported command index	0x41	The command sent is not supported
Invalid command header	0x42	The command header sent contains an invalid value
Invalid command interface module length	0x43	The length of the command interface command is invalid
Invalid request payload data	0x44	-

2023-06

Designation	Value	Description
Reserved	0x45 – 0x47	-
Command conflict	0x48	The command sent conflicts with another command
Reserved	0x4A – 0x4B	-
Invalid configured slave address	0x4D	The configured node address is invalid
Auto addressing in progress	0x50	The command could not be executed because the master addresses automatically
Normal operation required	0x51	The command requires the gateway to be in normal operation
Permanent data access error	0x52	Error during permanent data access
Device not activated	0x53	For example, when a user sends a parameter to a device that is not in LAS
Management phase busy	0x54	Command cannot be executed because the gateway is already executing a command
Undefined status	0x7F	Undefined error

Table 5.23

5.2.2.5 Gateway Record Modules

The Gateway Record Module can be used to access information from the gateway via acyclic PROFINET services. The configuration of the gateway can be changed.



Tip

Siemens TIA uses function blocks SFB52 "RDREC: Read data set" and SFB53 "WRREC: Write data set" for this purpose.

Master Data Module

Module	Number of segments	Description
AS-Interface gateway record module	1	Acyclic PROFINET services in segment 1
Line 1: AS-Interface gateway record module	2	Acyclic PROFINET services in segment 1
Line 2: AS-Interface gateway record module	2	Acyclic PROFINET services in segment 2

Table 5.24

In the case of PROFINET, acyclic data is exchanged via the "Record" service.

Assignment of AS-Interface/PROFINET

AS-Interface	PROFINET			Reference
Control functions	Service	Index	Select node	
Read_IDI	RecordDataRead	0x01		See chapter 9.1
Write_ODI	RecordDataWrite	0x02		See chapter 9.2
Set_Permanent_Parameter	RecordDataWrite	0x03	Yes	See chapter 9.3
Get_Permanent_Parameter	RecordDataRead	0x04	Yes	See chapter 9.4

AS-Interface	PROFINET			Reference
Control functions	Service	Index	Select node	
Read_Parameter	RecordDataRead	0x06	Yes	See chapter 9.5
Set_Permanent_Configuration	RecordDataWrite	0x08	Yes	See chapter 9.6
Get_Permanent_Configuration	RecordDataRead	0x09	Yes	See chapter 9.7
Read_Actual_Configuration	RecordDataRead	0x0B	Yes	See chapter 9.8
Set_LPS	RecordDataWrite	0x0C		See chapter 9.9
Get_LPS	RecordDataRead	0x0D		See chapter 9.10
Get_LAS	RecordDataRead	0x0E		See chapter 9.11
Get_LDS	RecordDataRead	0x0F		See chapter 9.12
Get_Flags	RecordDataRead	0x10		See chapter 9.13
Set_Operation_Mode	RecordDataWrite	0x11		See chapter 9.14
Set_Offline_Mode	RecordDataWrite	0x12		See chapter 9.15
Set_Data_Exchange_Active	RecordDataWrite	0x13		See chapter 9.16
Change_Slave_Address	RecordDataWrite	0x14		See chapter 9.17
Set_Auto_Addr_Enable	RecordDataWrite	0x15		See chapter 9.18
Get_Auto_Addr_Enable	RecordDataRead			See chapter 9.19
Get_LPF	RecordDataRead	0x17		See chapter 9.20
Write_Extended_ID-Code_1	RecordDataWrite	0x18		See chapter 9.21
Read_AIDI	RecordDataRead	0x19		See chapter 9.22
Write_AODI	RecordDataWrite	0x1A		See chapter 9.23
Get_Delta_List	RecordDataRead	0x40		See chapter 9.24
Get_LCS	RecordDataRead	0x41		See chapter 9.25
Write_Parameter	RecordDataWrite	0x42	Yes	See chapter 9.26
Read_Response_To_Write_Parameter	RecordDataRead		Yes	See chapter 9.27
Reset_Slave	RecordDataWrite	0x43	Yes	See chapter 9.28
Read_Response_to_Reset_Slave	RecordDataRead		Yes	See chapter 9.29
Select_Slave	RecordDataWrite	0x44	Yes	See chapter 9.30

AS-Interface	PROFINET			Reference
Control functions	Service	Index	Select node	
Store_Actual_Parameters	RecordDataWrite	0x45		See chapter 9.31
Store_Actual_Configuration	RecordDataWrite	0x46		See chapter 9.32
Set_Motor_Control_Config	RecordDataWrite	0x47	Yes	See chapter 9.33

Table 5.25

5.2.3 Channel Diagnosis

I/O modules of a PLC have a plug-in design and are organized by slot numbers. Each I/O module features multiple input and/or output connections. These connections are referred to as channels. If a fault occurs on one of the channels, the PROFINET diagnostic service locates this event by slot and channel. If a fault occurs on one of the channels, the PROFINET diagnostic service locates this event by slot and channel.

Each PLC features an individual software function for evaluating the PROFINET channel diagnosis. Read the details in the documentation for your PLC.

The AS-Interface gateway is a modular PROFINET node that provides a total of 32 slots. The PROFINET diagnostic service is connected to the "Flags + Fault Det." software modules, with one per AS-Interface segment. The modules can only be plugged into specific slots. In this way, the module "Line 1: Flags + Fault Det. can only be used on slot 1 and the module "Line 2: Flags + Fault Det. can only be used on slot 2.

Each AS-Interface node address corresponds to one channel: Node 1/1A = channel 1, node 2/2A = channel 2 etc. 32 channels are added for AS-Interface nodes with B addresses: Node 1B = channel 33, node 2B = channel 34 etc.

The following diagnostic messages are currently available in English.

Channel Errors

English error text	Description	Help
Detected device on AS-Interface address 0.	Erkanntes Gerät auf AS-i-Adresse 0.	A device was detected at AS-Interface address 0. Either remove the device or assign it a valid non-zero unused AS-Interface address to correct this error.
Configuration error on AS-Interface segment.	Configuration error on AS-Interface segment.	Detected and predicted configuration mismatch on the AS-Interface line for at least one AS-Interface device.
Auto address assignment is not possible on AS-Interface segment.	Am ASi-Strang ist keine automatische Adressvergabe möglich.	Auto address assignment is not possible on AS-Interface segment.
Auto address assignment is available on AS-Interface line.	Auto address assignment is available on AS-Interface line.	Auto address assignment is available on AS-Interface line.
Configuration mode is active on AS-Interface segment.	Am ASi-Strang ist der Konfigurationsmodus aktiv.	Configuration mode is active on AS-Interface segment.

English error text	Description	Help
No normal operation on AS-Interface segment.	Kein normaler Betrieb auf dem ASi-Strang.	Kein normaler Betrieb auf dem ASi-Strang.
AS-Interface power failure on AS-Interface segment.	ASi-Spannungsausfall am ASi-Strang.	AS-Interface power failure detected on the AS-Interface segment.
AS-Interface segment's AS-Interface master is offline.	Der ASi-Master des ASi-Strangs ist offline.	AS-Interface segment's AS-Interface master is offline.
AS-Interface segment reported periphery fault.	ASi-Strang hat Peripheriefehler gemeldet.	AS-Interface segment reported peripheral fault.
Earth fault detected on AS-Interface segment.	Erdschluss auf ASi-Strang erkannt.	Earth fault detected on AS-Interface segment.
Gateway detected configuration error on an AS-Interface address.	Gateway hat Konfigurationsfehler an einer ASi-Adresse erkannt.	Check the channel number to obtain the AS-Interface device address where the expected and detected configuration do not match.
At least one device reported a peripheral fault on AS-Interface segment.	At least one device has reported a peripheral fault on the AS-Interface segment.	Check the channel number to obtain the AS-Interface device address that reported a peripheral fault.

Table 5.26

Note

Multiple diagnostic messages that have a common cause are often displayed. Combine diagnostic messages to identify the cause.

Note

The diagnostics messages described below show the SIEMENS TIA Portal V 14 configuration software. When using a programmable logic controller from a different controller provider, please refer to the corresponding documentation.



Example

The AS-Interface node "1" is added without being known to the AS-Interface gateway. There is a single configuration error, no automatic address assignment is possible.

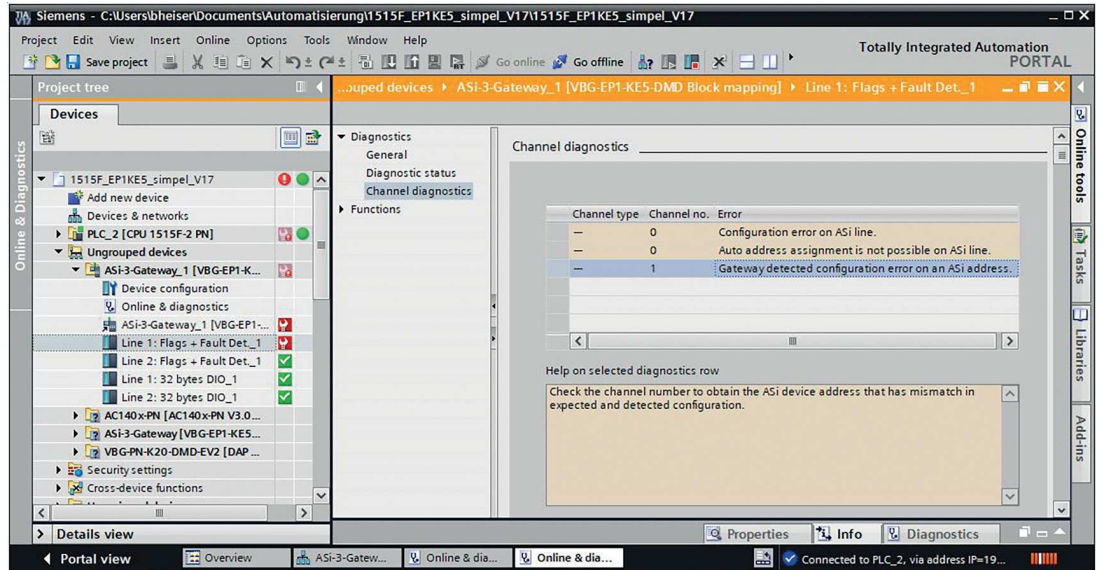

Figure 5.24

The example refers to AS-Interface segment 2. This results from the tree structure under "Devices."



Example

The configured AS-Interface node "1" has been removed.

There is a single configuration error. Automatic address assignment is possible as soon as a suitable node with the address 0 is added.

The AS-Interface node address is in the "Channel" column.

Channel number 0

- describes the address of the AS-Interface node with the address 0
- describes a message that refers to the AS-Interface gateway

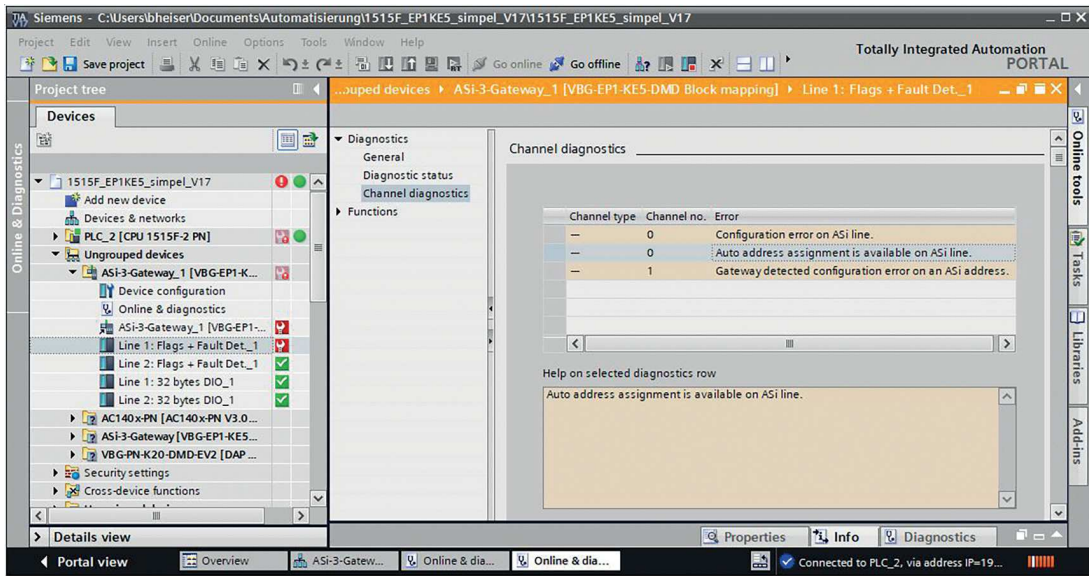

Figure 5.25

The example refers to AS-Interface segment 2. This results from the tree structure under "Devices."

Entries are created in the diagnostic buffer of the CPU in addition to the diagnostic messages on slots 1+2 of the AS-Interface gateway.



Example

The configuration error refers to AS-Interface node 1.

There are several entries whose information must be combined.

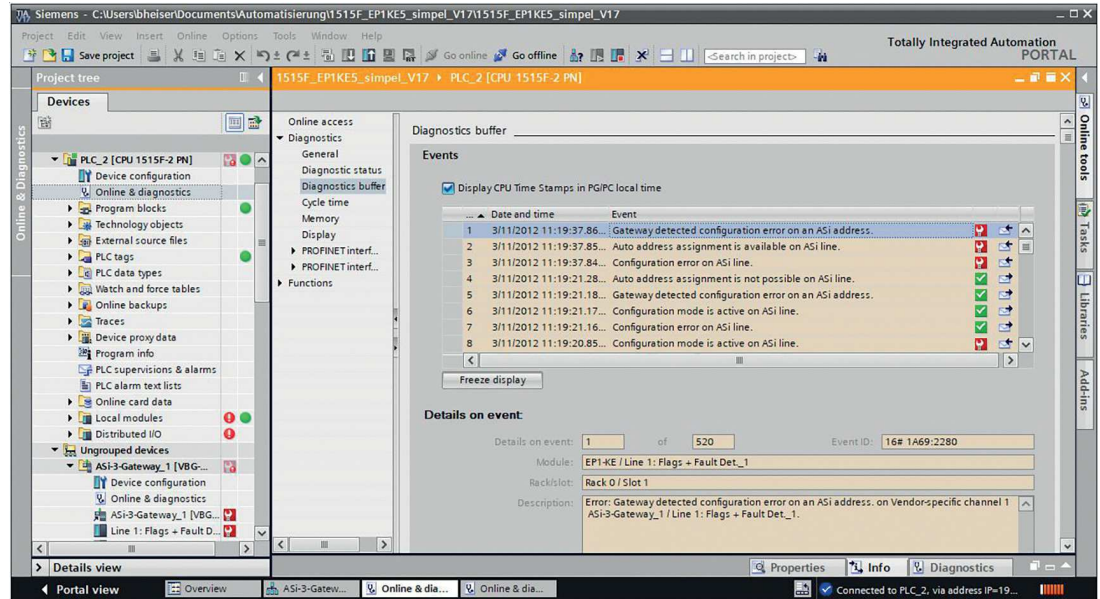

Figure 5.26

The example refers to AS-Interface segment 2.

5.3 EtherNet/IP

5.3.1 Preparation

To connect a gateway to the controller, you need an EDS file. Each gateway version requires its own EDS file.

Switching to EtherNet/IP Mode

The standard protocol of the ASI gateway is PROFINET. You can switch the protocol using the push button.



Switching the Protocol

1. Press and hold the push button for at least five seconds.

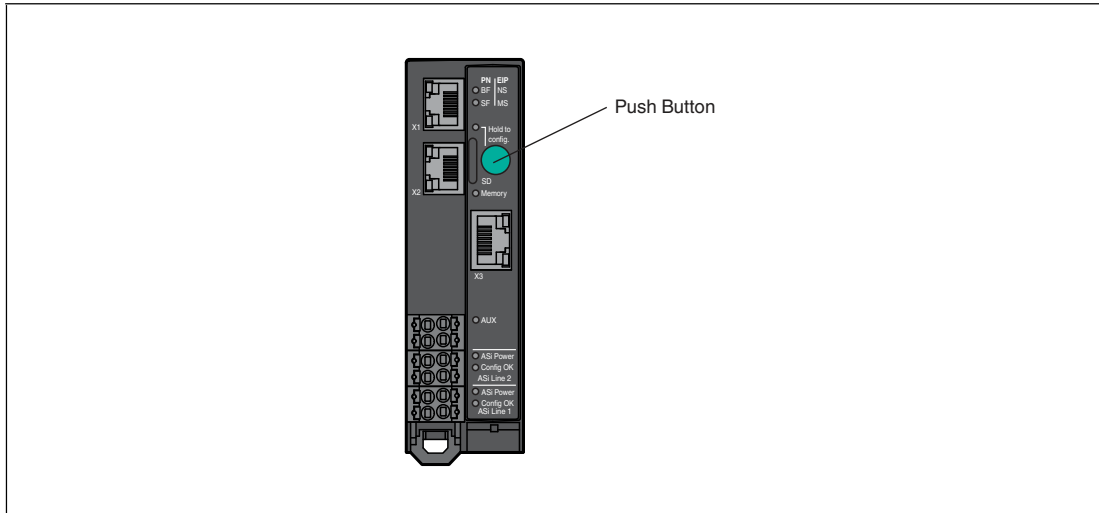

Figure 5.27

- ↳ The gateway switches to configuration mode.
 - ↳ The Config OK ASi Line 1 LED flashes.
2. **VBG-EP1-KE5-DMD**: Short-press the push button four times.
VBG-EP1-KE5-D: Short-press the push button twice.
 - ↳ The SF/MS LED flashes.
 3. Press and hold the push button for at least five seconds.
 - ↳ The gateway switches the protocol to EtherNet/IP.

Downloading the EDS File

You can find the relevant EDS file in the "Software" section of the product detail page for your device.

Use the hardware or network configuration tools from the manufacturer of your controller to install the EDS file of your gateway. After installation, you will find the gateway in the hardware catalog as a "General Purpose Discrete I/O" device.

Reading the MAC Address

Each gateway has a unique MAC address that cannot be changed by the user. The assigned MAC address is printed on the right-hand side of the device.

Setting the Network Parameters

The gateway uses the DHCP protocol to set the required network parameters, such as IP address and subnet mask.



Tip

You can change the network settings using the X3 diagnostic port. The default IP address of X3 is 192.168.1.2.



Setting the Network Parameters Using the BootP DHCP Tool

1. In a Rockwell development environment, we recommend using the "BootP DHCP Tool" program to set the correct IP address. This tool is included automatically when Studio 5000 is installed or can be downloaded separately from the Rockwell Automation Support Center.

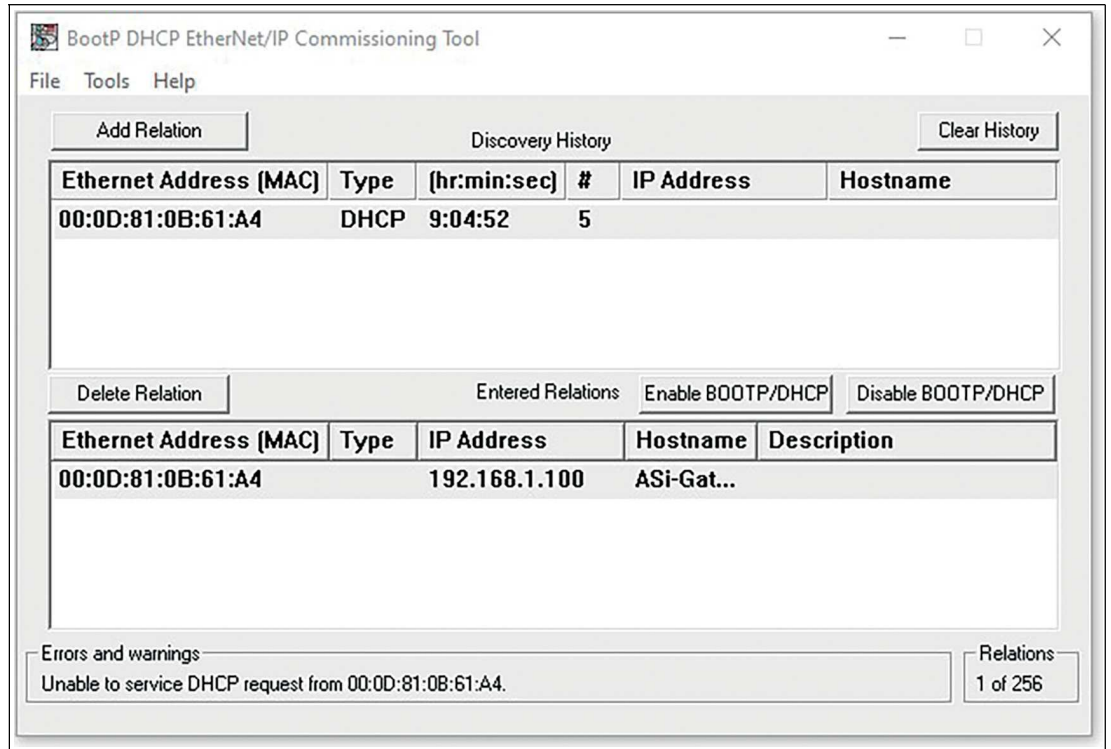

Figure 5.28



Setting the Network Parameters Using RSLinx Classic Lite

1. You can use RSLinx to change the settings once the network settings have been set.

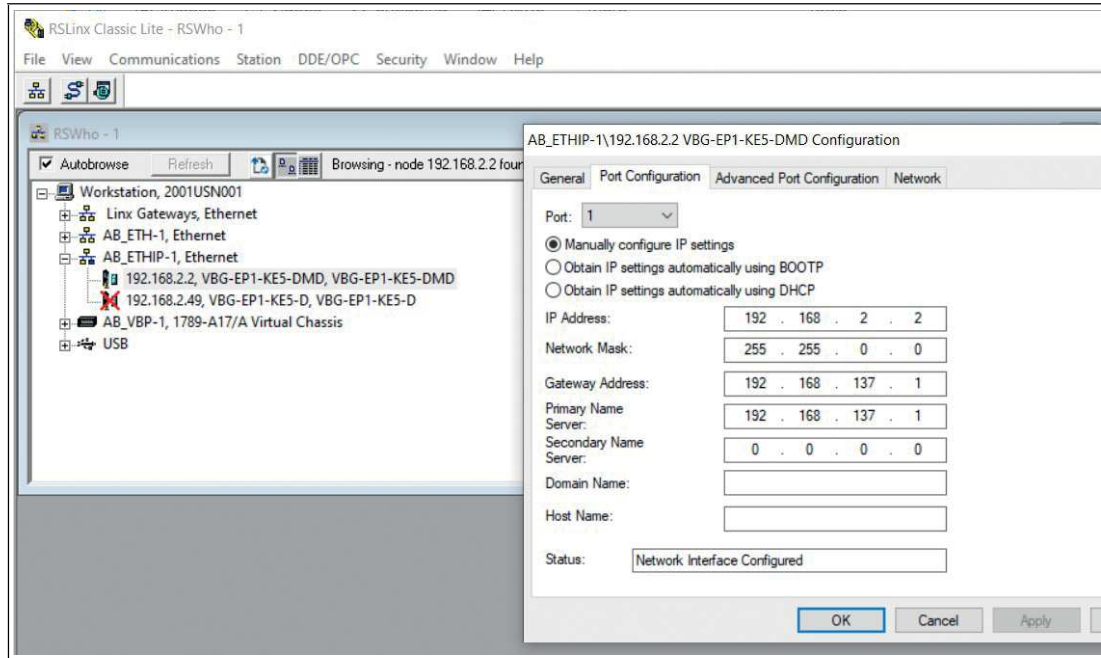

Figure 5.29

5.3.2 Configuration

Implicit and Explicit Messaging

The ASi gateway supports implicit and explicit messaging for EtherNet/IP communication.

- I/O process data is exchanged cyclically via assembly objects and an existing connection using implicit messaging.
- Low-priority data, non-time-critical data, and configuration and diagnostic data can be exchanged via non-cyclical messages using explicit messaging.

Connections and Assembly Objects

The ASi gateway only supports the "Exclusive Owner" connection type for the exchange of I/O process data and communication via implicit messaging.

- **Exclusive owner**
This connection is bidirectional: The controller sends data to the gateway and the gateway sends data to the controller. This type of connection is referred to as "exclusive owner" because it connects a gateway to just **one** controller.

5.3.2.1 Connections and Assembly Objects



Note

The possible connections for the ASi gateway with configurable inputs and outputs are listed



Note

For the bit assignment of the process data, see chapter 5.3.3.

I/O Connections for VBG-EP1-KE5-D Single Master

Connection	Connection type	Diagnostics ¹	Instance ID	Length (bytes)
DIO (digital in/out)	Exclusive owner	No	Output: 100	32
			Input: 101	32
			Configuration: -	-
DIO Diagnostics (digital in/out and diagnostics)	Exclusive owner	Yes	Output: 100	32
			Input: 103	66
			Configuration: 104	256
DIO Diagnostics AIO (digital in/out, diagnostics and analog in/out)	Exclusive owner	Yes	Output: 102	72
			Input: 105	106
			Configuration: 104	256

Table 5.27

1. Contains diagnostic information

I/O Connections for VBG-EP1-KE5-DMD Double Master

Connection	Connection type	Diagnostics	Instance ID	Length (bytes)
DIO (digital in/out)	Exclusive owner	No	Output: 100	64
			Input: 101	64
			Configuration: -	-
DIO Diagnostics (digital in/out and diagnostics)	Exclusive owner	Yes	Output: 100	64
			Input: 103	132
			Configuration: 104	256
DIO Diagnostics AIO (digital in/out, diagnostics and analog in/out)	Exclusive owner	Yes	Output: 102	144
			Input: 105	212
			Configuration: 104	256

Table 5.28

5.3.2.2 Configuration Parameters

Depending on the connection, different assembly objects are used to transfer the configuration parameters for the gateway. See chapter 5.3.2.1. Each gateway has a fixed number of configuration parameters. The size for the configuration assembly instance is always 256 bytes. For details on the structure of configuration parameters, see "Configuration Data, Instance ID: 104" on page 93.

- VBG-EP1-KE5-D single master: uses the first 32 words (= 64 bytes) for the configuration parameters
- VBG-EP1-KE5-DMD double master: uses the first 63 words (= 126 bytes) for the configuration parameters

The following configuration parameters are available:

- Configuration assembly version
- Use_Activation_Parameter_Config
- Activation parameters per network and per node
- Configuration of the channels of the analog nodes
- Configuration of the AS-Interface addresses of the analog nodes

5.3.2.3 Configuration Example

The procedure for configuring and commissioning gateways described here is based on Rockwell Automation "Studio 5000" software. If you are using a control system from a different manufacturer, please refer to the relevant documentation. The configuration is based on the example of the VBG-EP1-KE5-DMD double master. The configuration for other gateway versions is the same as the example, with a few minor adjustments.



Configuring VBG-EP1-KE5-DMD with Studio 5000

1. Install the EDS files for the gateway in RSLogix5000 using the EDS hardware installation tool in the "Tools" menu.
2. Select your controller.
3. Add your gateway to your EtherNet/IP communication interface by right-clicking and running the "New Module..." command.

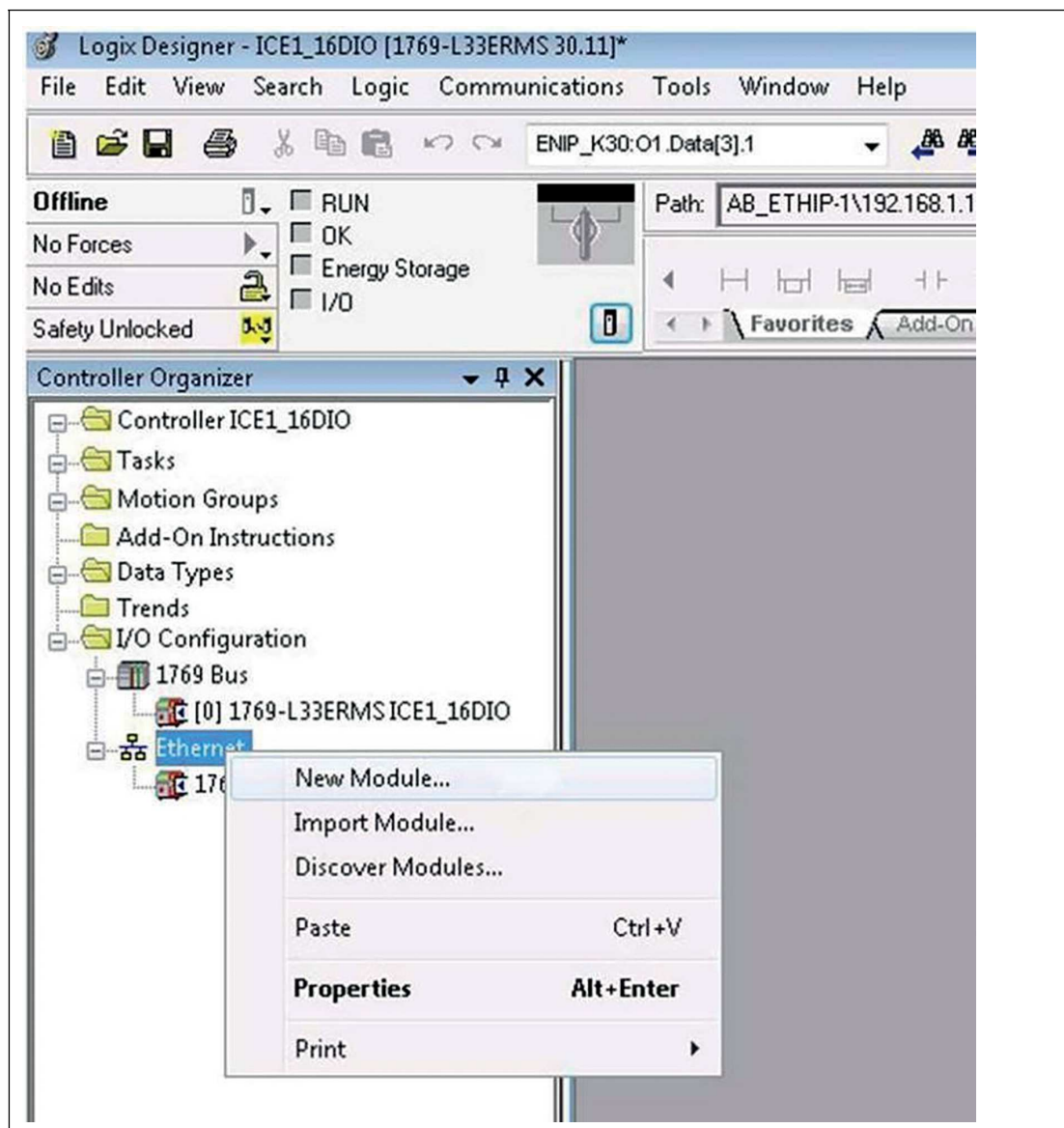

Figure 5.30

- Select the gateway you want to add. Click the "Create" button.

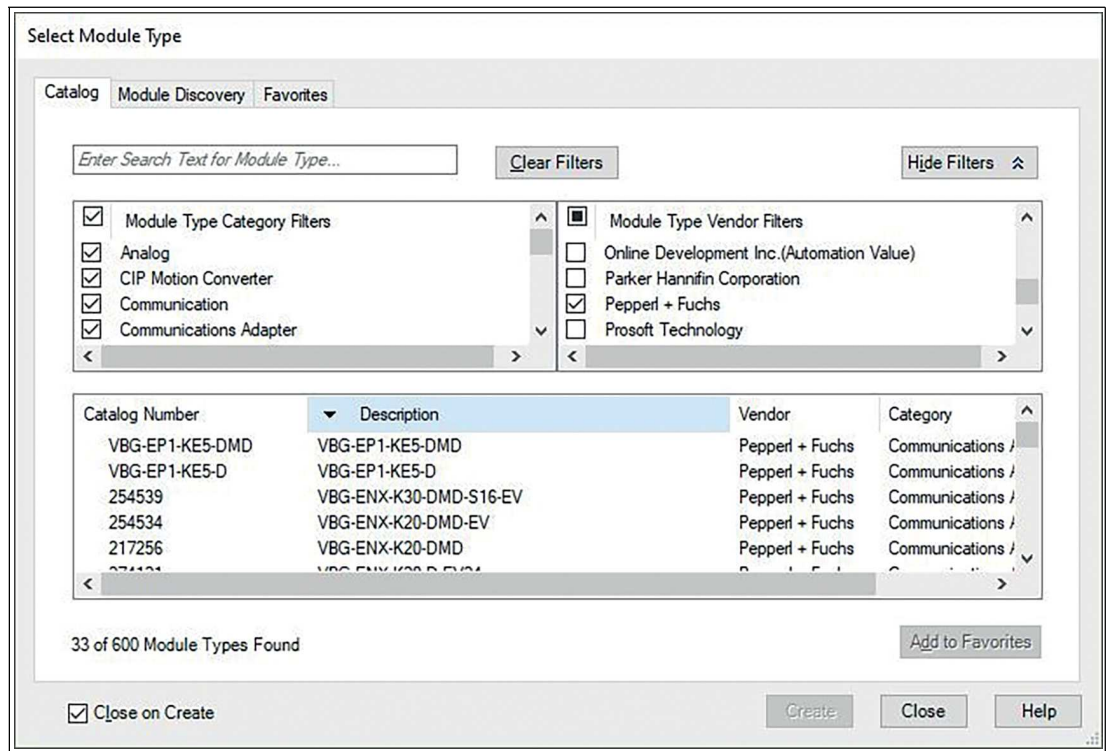

Figure 5.31

- Name the gateway. Enter the correct IP address.
- The name "ep1_ke5" and the IP address "192.168.1.12" have been used in this example.
- Click the "Change" button.

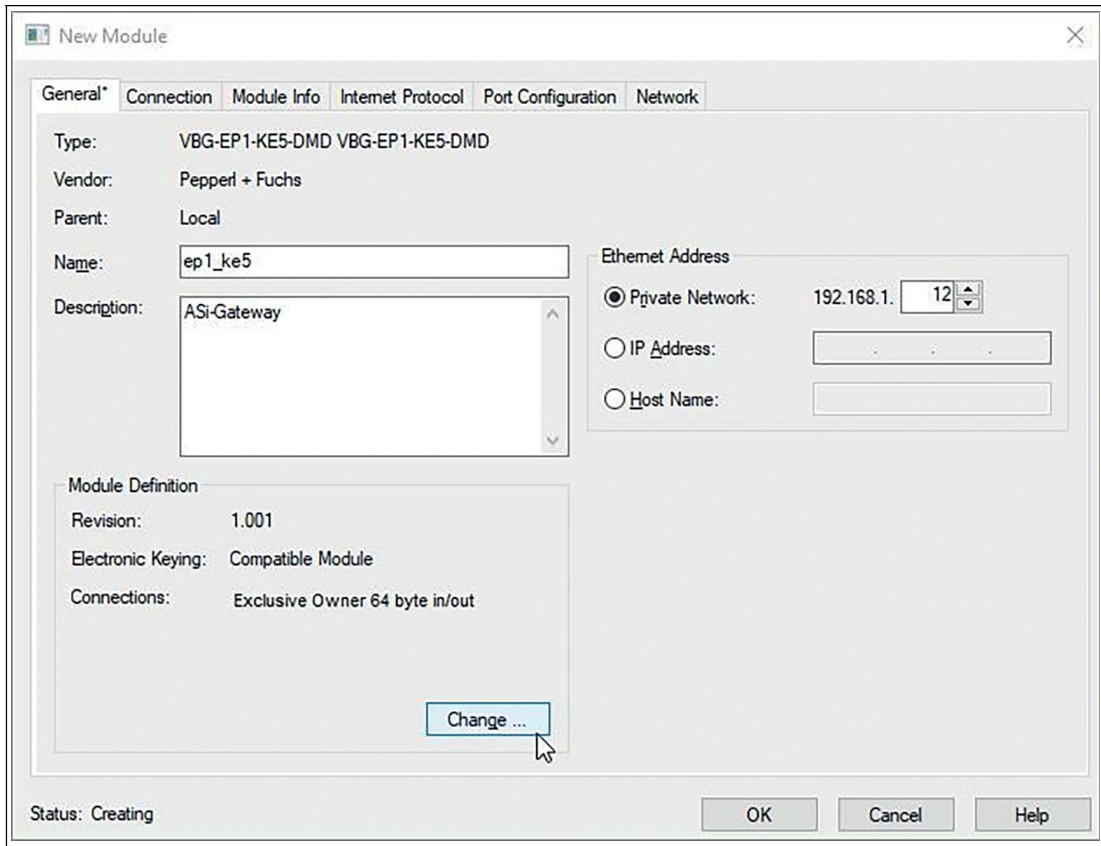

Figure 5.32

8. Change the revision, electronic coding, and connection type of the gateway. For more detailed information on connection types, see chapter 5.3.2.1.

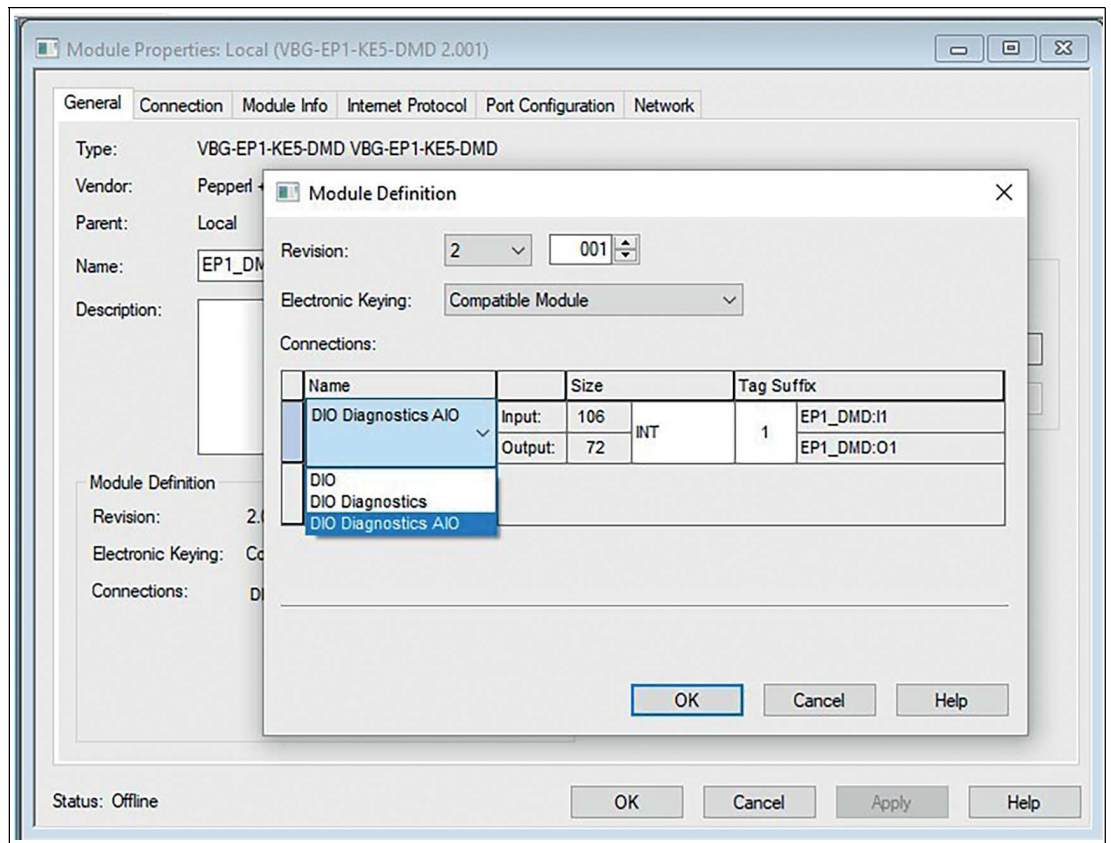

Figure 5.33

9. In the "Connection" tab, select the type of connection. This determines which process and diagnostic data the gateway provides.
10. The "Connection" tab in the gateway properties displays the connection type selected. You can also set the "Requested Packet Interval (RPI)" and "Input Type" in this tab. The minimum value for the "RPI" parameter is 10 ms.

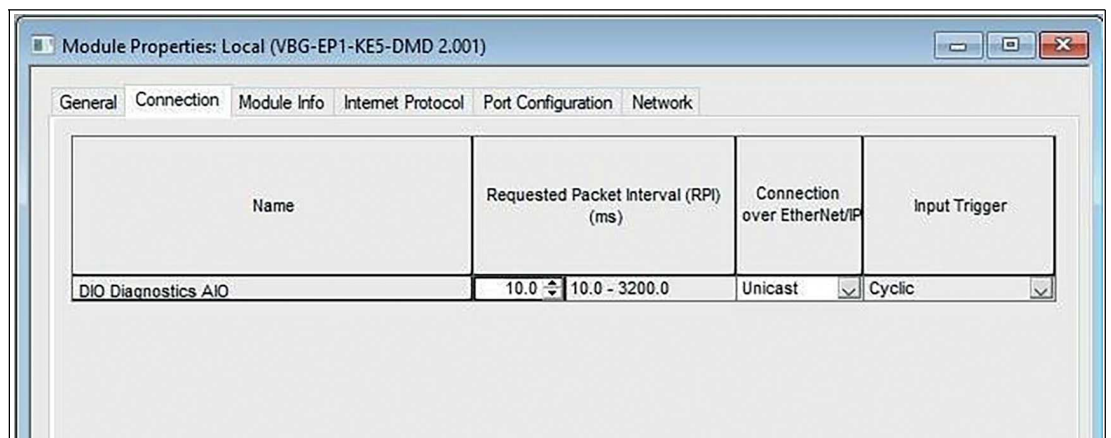

Figure 5.34

11. Confirm the entries with "OK".
12. In the "Controller Organizer," switch to the "Controller Tags" section. The controller tags for the configuration parameters have the same name as the gateway, followed by: c .
13. You can define one parameter per node.

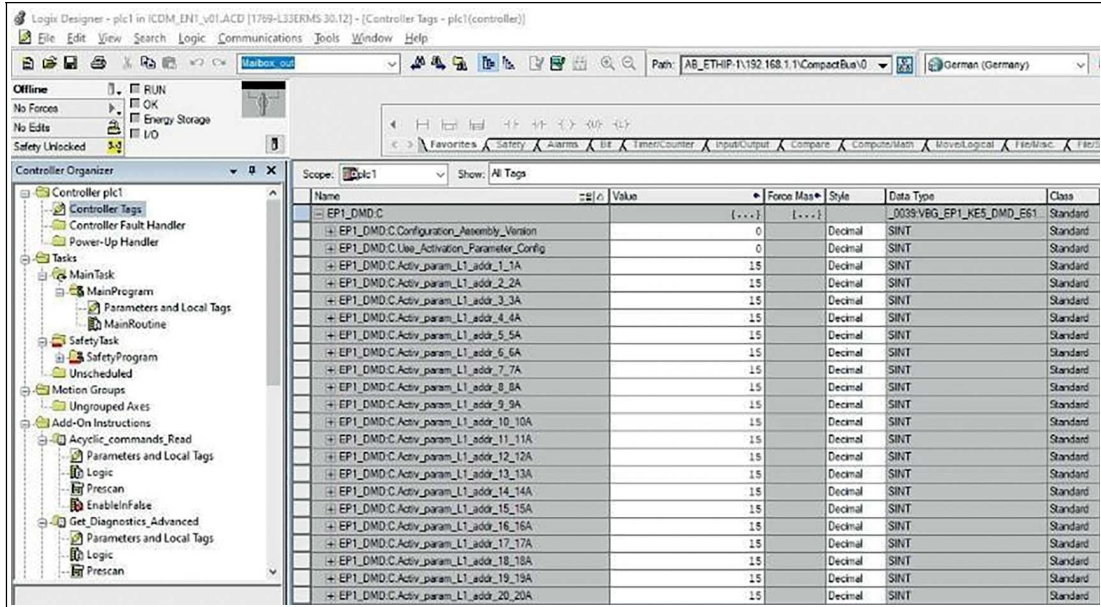

Figure 5.35

- Configure the EtherNet/IP gateway and download the parameters to the controller.

5.3.3 Bit Assignment of the Process Data

Input and Output Data

Input data is read and output data is written. Different data sets are available based on the assembly objects selected. Digital, diagnostic, and analog data can be mapped.

DIO

DIO stands for digital inputs and outputs. Only IO from addresses 1/1A-31/31A and 1B-31B for network 1 for the single network gateway or addresses 1/1A-31/31A and 1B-31B for both networks 1 and 2 for the dual network gateway are mapped.

VBG-EP1-KE5-D Input Data, SINT Format, Instance ID: 101

Byte	Bit 7	Bit 6	Bit 5	Bit 4	Bit 3	Bit 2	Bit 1	Bit 0
0	F3	F2	F1	F0	Node 1/1A			
1	Node 2/2A				Node 3/3A			
...			
15	Node 30/30A				Node 31/31A			
16	Reserved				Node 1B			
17	Node 2B				Node 3B			
...			
31	Node 30B				Node 31B			

Table 5.29

VBG-EP1-KE5-D Output Data, SINT Format, Instance ID: 100

Byte	Bit 7	Bit 6	Bit 5	Bit 4	Bit 3	Bit 2	Bit 1	Bit 0
0	-	-	-	-	Node 1/1A			
1	Node 2/2A				Node 3/3A			
...			
15	Node 30/30A				Node 31/31A			
16	Reserved				Node 1B			
17	Node 2B				Node 3B			
...			
31	Node 30B				Node 31B			

Table 5.30

VBG-EP1-KE5-D Input Data, INT Format, Instance ID: 101

INT	Bit															
	15	14	13	12	11	10	9	8	7	6	5	4	3	2	1	0
0	Node 2/2A				Node 3/3A				F3	F2	F1	F0	Node 1/1A			
1	Node 6/6A				Node 7/7A				Node 4/4A				Node 5/5A			
...			
7	Node 30/30A				Node 31/31A				Node 28/28A				Node 29/29A			
8	Node 2B				Node 3B				Reserved				Node 1B			
...			
15	Node 30B				Node 31B				Node 28B				Node 29B			

Table 5.31

VBG-EP1-KE5-D Output Data, INT Format, Instance ID: 100

INT	Bit															
	15	14	13	12	11	10	9	8	7	6	5	4	3	2	1	0
0	Node 2/2A				Node 3/3A				-	-	-	-	Node 1/1A			
1	Node 6/6A				Node 7/7A				Node 4/4A				Node 5/5A			
...			
7	Node 30/30A				Node 31/31A				Node 28/28A				Node 29/29A			
8	Node 2B				Node 3B				Reserved				Node 1B			
...			
15	Node 30B				Node 31B				Node 28B				Node 29B			

Table 5.32

VBG-EP1-KE5-DMD Input Data, SINT Format, Instance ID: 101

Byte	Bit 7	Bit 6	Bit 5	Bit 4	Bit 3	Bit 2	Bit 1	Bit 0
Network 1								
0	F3	F2	F1	F0	Node 1/1A			
1	Node 2/2A				Node 3/3A			
...			
15	Node 30/30A				Node 31/31A			
16	Reserved				Node 1B			
17	Node 2B				Node 3B			
...			
31	Node 30B				Node 31B			
Network 2								
32	F3	F2	F1	F0	Node 1/1A			
...			
48	Reserved				Node 1B			
49	Node 2B				Node 3B			
...			
63	Node 30B				Node 31B			

Table 5.33

VBG-EP1-KE5-DMD Output Data, SINT Format, Instance ID: 100

Byte	Bit 7	Bit 6	Bit 5	Bit 4	Bit 3	Bit 2	Bit 1	Bit 0
Network 1								
0	-	-	-	-	Node 1/1A			
1	Node 2/2A				Node 3/3A			
...			
15	Node 30/30A				Node 31/31A			
16	Reserved				Node 1B			
17	Node 2B				Node 3B			
...			
31	Node 30B				Node 31B			
Network 2								
32	-	-	-	-	Node 1/1A			
...			
48	Reserved				Node 1B			
49	Node 2B				Node 3B			
...			
63	Node 30B				Node 31B			

Table 5.34

VBG-EP1-KE5-DMD Input Data, INT Format, Instance ID: 101

INT	Bit															
	15	14	13	12	11	10	9	8	7	6	5	4	3	2	1	0
Network 1																
0	Node 2/2A				Node 3/3A				F3	F2	F1	F0	Node 1/1A			
1	Node 6/6A				Node 7/7A				Node 4/4A				Node 5/5A			
...			
7	Node 30/30A				Node 31/31A				Node 28/28A				Node 29/29A			
8	Node 2B				Node 3B				Reserved				Node 1B			
...			
15	Node 30B				Node 31B				Node 28B				Node 29B			
Network 2																
16	Node 2/2A				Node 3/3A				F3	F2	F1	F0	Node 1/1A			
17	Node 6/6A				Node 7/7A				Node 4/4A				Node 5/5A			
...			
23	Node 30/30A				Node 31/31A				Node 28/28A				Node 29/29A			
24	Node 2B				Node 3B				Reserved				Node 1B			
...			
31	Node 30B				Node 31B				Node 28B				Node 29B			

Table 5.35

VBG-EP1-KE5-DMD Output Data, INT Format, Instance ID: 100

INT	Bit															
	15	14	13	12	11	10	9	8	7	6	5	4	3	2	1	0
Network 1																
0	Node 2/2A				Node 3/3A				-	-	-	-	Node 1/1A			
1	Node 6/6A				Node 7/7A				Node 4/4A				Node 5/5A			
...			
7	Node 30/30A				Node 31/31A				Node 28/28A				Node 29/29A			
8	Node 2B				Node 3B				Reserved				Node 1B			
...			
15	Node 30B				Node 31B				Node 28B				Node 29B			
Network 2																
16	Node 2/2A				Node 3/3A				-	-	-	-	Node 1/1A			
17	Node 6/6A				Node 7/7A				Node 4/4A				Node 5/5A			
...			
23	Node 30/30A				Node 31/31A				Node 28/28A				Node 29/29A			
24	Node 2B				Node 3B				Reserved				Node 1B			
...			
31	Node 30B				Node 31B				Node 28B				Node 29B			

Table 5.36

DIO + Diagnostic Data

In addition to the input and output data for both networks, diagnostic data is also included in the mapping. The diagnostic data includes the lists of detected, projected, and activated nodes and the list of peripheral faults. Master flags are also included to give you additional information about the status of the two networks. For detailed information on the master flags, see table "Diagnostic Bits" on page 91.

VBG-EP1-KE5-D Input Data, SINT Format, Instance ID: 103

Byte	Bit 7	Bit 6	Bit 5	Bit 4	Bit 3	Bit 2	Bit 1	Bit 0
0	F3	F2	F1	F0	Node 1/1A			
1	Node 2/2A				Node 3/3A			
...			
15	Node 30/30A				Node 31/31A			
16	Reserved				Node 1B			
17	Node 2B				Node 3B			
...			
31	Node 30B				Node 31B			
32	-	-	-	Earth Fault	-	-	-	Peripheral Fault
33	Offline	Power Fail	In Normal Operation	Config mode act	Auto Adr avail	Auto Adr not pos	LDS.0	Config Error
34	LDS							
	7A	6A	5A	4A	3A	2A	1A	0
35	LDS							
	15A	14A	13A	12A	11A	10A	9A	8A
...
38	LDS							
	7B	6B	5B	4B	3B	2B	1B	0
...
41	LDS							
	31B	30B	29B	28B	27B	26B	25B	24B
42	LPS							
	7A	6A	5A	4A	3A	2A	1A	0
...
45	LPS							
	31A	30A	29A	28A	27A	26A	25A	24A
46	LPS							
	7B	6B	5B	4B	3B	2B	1B	0
...
49	LPS							
	31B	30B	29B	28B	27B	26B	25B	24B
50	LAS							
	7A	6A	5A	4A	3A	2A	1A	0
...

2023-06

Byte	Bit 7	Bit 6	Bit 5	Bit 4	Bit 3	Bit 2	Bit 1	Bit 0
53	LAS							
	31A	30A	29A	28A	27A	26A	25A	24A
54	LAS							
	7B	6B	5B	4B	3B	2B	1B	0
...
57	LAS							
	31B	30B	29B	28B	27B	26B	25B	24B
58	LPF							
	7A	6A	5A	4A	3A	2A	1A	0
...
61	LPF							
	31A	30A	29A	28A	27A	26A	25A	24A
62	LPF							
	7B	6B	5B	4B	3B	2B	1B	0
...
65	LPF							
	31B	30B	29B	28B	27B	26B	25B	24B

Table 5.37

VBG-EP1-KE5-D Output Data, SINT Format, Instance ID: 100

Byte	Bit 7	Bit 6	Bit 5	Bit 4	Bit 3	Bit 2	Bit 1	Bit 0
0	-	-	-	-	Node 1/1A			
1	Node 2/2A				Node 3/3A			
...			
15	Node 30/30A				Node 31/31A			
16	Reserved				Node 1B			
17	Node 2B				Node 3B			
...			
31	Node 30B				Node 31B			

Table 5.38

VBG-EP1-KE5-D Input Data, INT Format, Instance ID: 103

INT	Bit															
	15	14	13	12	11	10	9	8	7	6	5	4	3	2	1	0
0	Node 2/2A				Node 3/3A				F3	F2	F1	F0	Node 1/1A			
1	Node 6/6A				Node 7/7A				Node 4/4A				Node 5/5A			
...			
7	Node 30/30A				Node 31/31A				Node 28/28A				Node 29/29A			
8	Node 2B				Node 3B				Reserved				Node 1B			
...			
15	Node 30B				Node 31B				Node 28B				Node 29B			
16	Offline	Power fail	In Normal Operation	Cfg mode act	Auto Adr avail	Auto Adr not Pos	LDS.0	Cfg error	.	.	.	Earth Fault	.	.	.	Peripheral Fault
17	LDS															
	15A	14A	13A	12A	11A	10A	9A	8A	7A	6A	5A	4A	3A	2A	1A	0
18	LDS															
	31A	30A	29A	28A	27A	26A	25A	24A	23A	22A	21A	20A	19A	18A	17A	16A
19	LDS															
	15B	14B	13B	12B	11B	10B	9B	8B	7B	6B	5B	4B	3B	2B	1B	0
20	LDS															
	31B	30B	29B	28B	27B	26B	25B	24B	23B	22B	21B	20B	19B	18B	17B	16B
21	LPS															
	15A	14A	13A	12A	11A	10A	9A	8A	7A	6A	5A	4A	3A	2A	1A	0
22	LPS															
	31A	30A	29A	28A	27A	26A	25A	24A	23A	22A	21A	20A	19A	18A	17A	16A
23	LPS															
	15B	14B	13B	12B	11B	10B	9B	8B	7B	6B	5B	4B	3B	2B	1B	0
24	LPS															
	31B	30B	29B	28B	27B	26B	25B	24B	23B	22B	21B	20B	19B	18B	17B	16B
25	LAS															
	15A	14A	13A	12A	11A	10A	9A	8A	7A	6A	5A	4A	3A	2A	1A	0
26	LAS															
	31A	30A	29A	28A	27A	26A	25A	24A	23A	22A	21A	20A	19A	18A	17A	16A
27	LAS															
	15B	14B	13B	12B	11B	10B	9B	8B	7B	6B	5B	4B	3B	2B	1B	0
28	LAS															
	31B	30B	29B	28B	27B	26B	25B	24B	23B	22B	21B	20B	19B	18B	17B	16B
29	LPF															
	15A	14A	13A	12A	11A	10A	9A	8A	7A	6A	5A	4A	3A	2A	1A	0

2023-06

INT	Bit															
	15	14	13	12	11	10	9	8	7	6	5	4	3	2	1	0
30	LPF															
	31A	30A	29A	28A	27A	26A	25A	24A	23A	22A	21A	20A	19A	18A	17A	16A
31	LPF															
	15B	14B	13B	12B	11B	10B	9B	8B	7B	6B	5B	4B	3B	2B	1B	0
32	LPF															
	31B	30B	29B	28B	27B	26B	25B	24B	23B	22B	21B	20B	19B	18B	17B	16B

Table 5.39

VBG-EP1-KE5-D Output Data, INT Format, Instance ID: 100

INT	Bit															
	15	14	13	12	11	10	9	8	7	6	5	4	3	2	1	0
0	Node 2/2A				Node 3/3A				0	0	0	0	Node 1/1A			
1	Node 6/6A				Node 7/7A				Node 4/4A				Node 5/5A			
...			
7	Node 30/30A				Node 31/31A				Node 28/28A				Node 29/29A			
8	Node 2B				Node 3B				Reserved				Node 1B			
...			
15	Node 30B				Node 31B				Node 28B				Node 29B			

Table 5.40

Table																
-------	--	--	--	--	--	--	--	--	--	--	--	--	--	--	--	--

VBG-EP1-KE5-DMD Input Data, SINT Format, Instance ID: 103

Byte	Bit 7	Bit 6	Bit 5	Bit 4	Bit 3	Bit 2	Bit 1	Bit 0
Network 1								
0	F3	F2	F1	F0	Node 1/1A			
1	Node 2/2A				Node 3/3A			
...			
15	Node 30/30A				Node 31/31A			
16	Reserved				Node 1B			
17	Node 2B				Node 3B			
...			
31	Node 30B				Node 31B			
Network 2								
32	F3	F2	F1	F0	Node 1/1A			
...			
48	Reserved				Node 1B			
49	Node 2B				Node 3B			
...			
63	Node 30B				Node 31B			
Network 1								

Byte	Bit 7	Bit 6	Bit 5	Bit 4	Bit 3	Bit 2	Bit 1	Bit 0
64	-	-	-	Earth Fault	-	-	-	Peripheral Fault
65	Offline	Power Fail	In Normal Operation	Config mode act	Auto Adr avail	Auto Adr not pos	LDS.0	Config Error
66	LDS							
	7A	6A	5A	4A	3A	2A	1A	0
...
69	LDS							
	31A	30A	29A	28A	27A	26A	25A	24A
70	LDS							
	7B	6B	5B	4B	3B	2B	1B	0
...
73	LDS							
	31B	30B	29B	28B	27B	26B	25B	24B
74	LPS							
	7A	6A	5A	4A	3A	2A	1A	0
...
77	LPS							
	31A	30A	29A	28A	27A	26A	25A	24A
78	LPS							
	7B	6B	5B	4B	3B	2B	1B	0
...
81	LPS							
	31B	30B	29B	28B	27B	26B	25B	24B
82	LAS							
	7A	6A	5A	4A	3A	2A	1A	0
...
85	LAS							
	31A	30A	29A	28A	27A	26A	25A	24A
86	LAS							
	7B	6B	5B	4B	3B	2B	1B	0
...
89	LAS							
	31B	30B	29B	28B	27B	26B	25B	24B
90	LPF							
	7A	6A	5A	4A	3A	2A	1A	0
...
93	LPF							
	31A	30A	29A	28A	27A	26A	25A	24A
94	LPF							
	7B	6B	5B	4B	3B	2B	1B	0

Byte	Bit 7	Bit 6	Bit 5	Bit 4	Bit 3	Bit 2	Bit 1	Bit 0
...
97	LPF							
	31B	30B	29B	28B	27B	26B	25B	24B
Network 2								
98	0	0	0	Earth Fault	0	0	0	Peripheral Fault
99	Offline	Power Fail	In Normal Operation	Config mode act	Auto Adr avail	Auto Adr not pos	LDS.0	Config Error
100	LDS							
	7A	6A	5A	4A	3A	2A	1A	0
...
103	LDS							
	31A	30A	29A	28A	27A	26A	25A	24A
104	LDS							
	7B	6B	5B	4B	3B	2B	1B	0
...
107	LDS							
	31B	30B	29B	28B	27B	26B	25B	24B
108	LPS							
	7A	6A	5A	4A	3A	2A	1A	0
...
111	LPS							
	31A	30A	29A	28A	27A	26A	25A	24A
112	LPS							
	7B	6B	5B	4B	3B	2B	1B	0
...
115	LPS							
	31B	30B	29B	28B	27B	26B	25B	24B
116	LAS							
	7A	6A	5A	4A	3A	2A	1A	0
...
119	LAS							
	31A	30A	29A	28A	27A	26A	25A	24A
120	LAS							
	7B	6B	5B	4B	3B	2B	1B	0
...
123	LAS							
	31B	30B	29B	28B	27B	26B	25B	24B
124	LPF							
	7A	6A	5A	4A	3A	2A	1A	0
...

Byte	Bit 7	Bit 6	Bit 5	Bit 4	Bit 3	Bit 2	Bit 1	Bit 0
127	LPF							
	31A	30A	29A	28A	27A	26A	25A	24A
128	LPF							
	7B	6B	5B	4B	3B	2B	1B	0
...
131	LPF							
	31B	30B	29B	28B	27B	26B	25B	24B

Table 5.42

VBG-EP1-KE5-DMD Output Data, SINT Format, Instance ID: 100

Byte	Bit 7	Bit 6	Bit 5	Bit 4	Bit 3	Bit 2	Bit 1	Bit 0
Network 1								
0	-	-	-	-	Node 1/1A			
1	Node 2/2A				Node 3/3A			
...			
15	Node 30/30A				Node 31/31A			
16	Reserved				Node 1B			
17	Node 2B				Node 3B			
...			
31	Node 30B				Node 31B			
Network 2								
32	-	-	-	-	Node 1/1A			
...			
48	Reserved				Node 1B			
49	Node 2B				Node 3B			
...			
63	Node 30B				Node 31B			

Table 5.43

VBG-EP1-KE5-DMD Input Data, INT Format, Instance ID: 103

INT	Bit															
	15	14	13	12	11	10	9	8	7	6	5	4	3	2	1	0
Network 1																
0	Node 2/2A				Node 3/3A				F3	F2	F1	F0	Node 1/1A			
1	Node 6/6A				Node 7/7A				Node 4/4A				Node 5/5A			
...			
7	Node 30/30A				Node 31/31A				Node 28/28A				Node 29/29A			
8	Node 2B				Node 3B				Reserved				Node 1B			
...			
15	Node 30B				Node 31B				Node 28B				Node 29B			
Network 2																
16	Node 2/2A				Node 3/3A				F3	F2	F1	F0	Node 1/1A			

2023-06

INT	Bit															
	15	14	13	12	11	10	9	8	7	6	5	4	3	2	1	0
17	Node 6/6A				Node 7/7A				Node 4/4A				Node 5/5A			
...			
23	Node 30/30A				Node 31/31A				Node 28/28A				Node 29/29A			
24	Node 2B				Node 3B				Reserved				Node 1B			
...			
31	Node 30B				Node 31B				Node 28B				Node 29B			
Network 1																
32	Offline	Power fail	In Normal Operation	Cfg mode act	Auto Adr avail	Auto Adr not Pos	LDS.0	Cfg error	0	0	0	Earth Fault	0	0	0	Peripheral Fault
33	LDS															
	15A	14A	13A	12A	11A	10A	9A	8A	7A	6A	5A	4A	3A	2A	1A	0
34	LDS															
	31A	30A	29A	28A	27A	26A	25A	24A	23A	22A	21A	20A	19A	18A	17A	16A
35	LDS															
	15B	14B	13B	12B	11B	10B	9B	8B	7B	6B	5B	4B	3B	2B	1B	0
36	LDS															
	31B	30B	29B	28B	27B	26B	25B	24B	23B	22B	21B	20B	19B	18B	17B	16B
37	LPS															
	15A	14A	13A	12A	11A	10A	9A	8A	7A	6A	5A	4A	3A	2A	1A	0
38	LPS															
	31A	30A	29A	28A	27A	26A	25A	24A	23A	22A	21A	20A	19A	18A	17A	16A
39	LPS															
	15B	14B	13B	12B	11B	10B	9B	8B	7B	6B	5B	4B	3B	2B	1B	0
40	LPS															
	31B	30B	29B	28B	27B	26B	25B	24B	23B	22B	21B	20B	19B	18B	17B	16B
41	LAS															
	15A	14A	13A	12A	11A	10A	9A	8A	7A	6A	5A	4A	3A	2A	1A	0
42	LAS															
	31A	30A	29A	28A	27A	26A	25A	24A	23A	22A	21A	20A	19A	18A	17A	16A
43	LAS															
	15B	14B	13B	12B	11B	10B	9B	8B	7B	6B	5B	4B	3B	2B	1B	0
44	LAS															
	31B	30B	29B	28B	27B	26B	25B	24B	23B	22B	21B	20B	19B	18B	17B	16B
45	LPF															
	15A	14A	13A	12A	11A	10A	9A	8A	7A	6A	5A	4A	3A	2A	1A	0
46	LPF															
	31A	30A	29A	28A	27A	26A	25A	24A	23A	22A	21A	20A	19A	18A	17A	16A

2023-06

INT	Bit															
	15	14	13	12	11	10	9	8	7	6	5	4	3	2	1	0
47	LPF															
	15B	14B	13B	12B	11B	10B	9B	8B	7B	6B	5B	4B	3B	2B	1B	0
48	LPF															
	31B	30B	29B	28B	27B	26B	25B	24B	23B	22B	21B	20B	19B	18B	17B	16B
Network 2																
49	Offline	Power fail	In Normal Operation	Cfg mode act	Auto Adr avail	Auto Adr not Pos	LDS.0	Cfg error	0	0	0	Earth Fault	0	0	0	Peripheral Fault
50	LDS															
	15A	14A	13A	12A	11A	10A	9A	8A	7A	6A	5A	4A	3A	2A	1A	0
51	LDS															
	31A	30A	29A	28A	27A	26A	25A	24A	23A	22A	21A	20A	19A	18A	17A	16A
52	LDS															
	15B	14B	13B	12B	11B	10B	9B	8B	7B	6B	5B	4B	3B	2B	1B	0
53	LDS															
	31B	30B	29B	28B	27B	26B	25B	24B	23B	22B	21B	20B	19B	18B	17B	16B
54	LPS															
	15A	14A	13A	12A	11A	10A	9A	8A	7A	6A	5A	4A	3A	2A	1A	0
55	LPS															
	31A	30A	29A	28A	27A	26A	25A	24A	23A	22A	21A	20A	19A	18A	17A	16A
56	LPS															
	15B	14B	13B	12B	11B	10B	9B	8B	7B	6B	5B	4B	3B	2B	1B	0
57	LPS															
	31B	30B	29B	28B	27B	26B	25B	24B	23B	22B	21B	20B	19B	18B	17B	16B
58	LAS															
	15A	14A	13A	12A	11A	10A	9A	8A	7A	6A	5A	4A	3A	2A	1A	0
59	LAS															
	31A	30A	29A	28A	27A	26A	25A	24A	23A	22A	21A	20A	19A	18A	17A	16A
60	LAS															
	15B	14B	13B	12B	11B	10B	9B	8B	7B	6B	5B	4B	3B	2B	1B	0
61	LAS															
	31B	30B	29B	28B	27B	26B	25B	24B	23B	22B	21B	20B	19B	18B	17B	16B
62	LPF															
	15A	14A	13A	12A	11A	10A	9A	8A	7A	6A	5A	4A	3A	2A	1A	0
63	LPF															
	31A	30A	29A	28A	27A	26A	25A	24A	23A	22A	21A	20A	19A	18A	17A	16A
64	LPF															
	15B	14B	13B	12B	11B	10B	9B	8B	7B	6B	5B	4B	3B	2B	1B	0

2023-06

INT	Bit															
	15	14	13	12	11	10	9	8	7	6	5	4	3	2	1	0
65	LPF															
	31B	30B	29B	28B	27B	26B	25B	24B	23B	22B	21B	20B	19B	18B	17B	16B

Table 5.44

VBG-EP1-KE5-DMD Output Data, INT Format, Instance ID: 100

INT	Bit																
	15	14	13	12	11	10	9	8	7	6	5	4	3	2	1	0	
Network 1																	
0	Node 2/2A				Node 3/3A				-	-	-	-	Node 1/1A				
1	Node 6/6A				Node 7/7A				Node 4/4A				Node 5/5A				
...				
7	Node 30/30A				Node 31/31A				Node 28/28A				Node 29/29A				
8	Node 2B				Node 3B				Reserved				Node 1B				
...				
15	Node 30B				Node 31B				Node 28B				Node 29B				
Network 2																	
16	Node 2/2A				Node 3/3A				-	-	-	-	Node 1/1A				
17	Node 6/6A				Node 7/7A				Node 4/4A				Node 5/5A				
...				
23	Node 30/30A				Node 31/31A				Node 28/28A				Node 29/29A				
24	Node 2B				Node 3B				Reserved				Node 1B				
...				
31	Node 30B				Node 31B				Node 28B				Node 29B				

Table 5.45

DIO + Diagnostic Data + Analog Data

In addition to the input, output, and diagnostic data, analog data is also included. Analog data includes five addresses from 27 to 31 for one or two networks. The analog data for each of the five addresses includes four 16-bit analog channels.

The associated analog start address and the channels can be configured using the configuration object. See "Diagnostic and Configuration Object 64hex" on page 98.

VBG-EP1-KE5-D Input Data, INT Format, Instance ID: 105

INT	Bit																
	15	14	13	12	11	10	9	8	7	6	5	4	3	2	1	0	
0	Node 2/2A				Node 3/3A				F3	F2	F1	F0	Node 1/1A				
1	Node 6/6A				Node 7/7A				Node 4/4A				Node 5/5A				
...				
7	Node 30/30A				Node 31/31A				Node 28/28A				Node 29/29A				
8	Node 2B				Node 3B				Reserved				Node 1B				
...				
15	Node 30B				Node 31B				Node 28B				Node 29B				

INT	Bit															
	15	14	13	12	11	10	9	8	7	6	5	4	3	2	1	0
16	Offline	Power fail	In Normal Operation	Cfg mode act	Auto Adr avail	Auto Adr not Pos	LDS.0	Cfg error	.	.	.	Earth Fault	.	.	.	Peripheral Fault
17	LDS															
	15A	14A	13A	12A	11A	10A	9A	8A	7A	6A	5A	4A	3A	2A	1A	0
18	LDS															
	31A	30A	29A	28A	27A	26A	25A	24A	23A	22A	21A	20A	19A	18A	17A	16A
19	LDS															
	15B	14B	13B	12B	11B	10B	9B	8B	7B	6B	5B	4B	3B	2B	1B	0
20	LDS															
	31B	30B	29B	28B	27B	26B	25B	24B	23B	22B	21B	20B	19B	18B	17B	16B
21	LPS															
	15A	14A	13A	12A	11A	10A	9A	8A	7A	6A	5A	4A	3A	2A	1A	0
22	LPS															
	31A	30A	29A	28A	27A	26A	25A	24A	23A	22A	21A	20A	19A	18A	17A	16A
23	LPS															
	15B	14B	13B	12B	11B	10B	9B	8B	7B	6B	5B	4B	3B	2B	1B	0
24	LPS															
	31B	30B	29B	28B	27B	26B	25B	24B	23B	22B	21B	20B	19B	18B	17B	16B
25	LAS															
	15A	14A	13A	12A	11A	10A	9A	8A	7A	6A	5A	4A	3A	2A	1A	0
26	LAS															
	31A	30A	29A	28A	27A	26A	25A	24A	23A	22A	21A	20A	19A	18A	17A	16A
27	LAS															
	15B	14B	13B	12B	11B	10B	9B	8B	7B	6B	5B	4B	3B	2B	1B	0
28	LAS															
	31B	30B	29B	28B	27B	26B	25B	24B	23B	22B	21B	20B	19B	18B	17B	16B
29	LPF															
	15A	14A	13A	12A	11A	10A	9A	8A	7A	6A	5A	4A	3A	2A	1A	0
30	LPF															
	31A	30A	29A	28A	27A	26A	25A	24A	23A	22A	21A	20A	19A	18A	17A	16A
31	LPF															
	15B	14B	13B	12B	11B	10B	9B	8B	7B	6B	5B	4B	3B	2B	1B	0
32	LPF															
	31B	30B	29B	28B	27B	26B	25B	24B	23B	22B	21B	20B	19B	18B	17B	16B
33	Analog Input Address 27, Channel 1															
34	Analog Input Address 27, Channel 2															
35	Analog Input Address 27, Channel 3															

2023-06

INT	Bit															
	15	14	13	12	11	10	9	8	7	6	5	4	3	2	1	0
36	Analog Input Address 27, Channel 4															
37	Analog Input Address 28, Channel 1															
38	Analog Input Address 28, Channel 2															
39	Analog Input Address 28, Channel 3															
40	Analog Input Address 28, Channel 4															
41	Analog Input Address 29, Channel 1															
42	Analog Input Address 29, Channel 2															
43	Analog Input Address 29, Channel 3															
44	Analog Input Address 29, Channel 4															
45	Analog Input Address 30, Channel 1															
46	Analog Input Address 30, Channel 2															
47	Analog Input Address 30, Channel 3															
48	Analog Input Address 30, Channel 4															
49	Analog Input Address 31, Channel 1															
50	Analog Input Address 31, Channel 2															
51	Analog Input Address 31, Channel 3															
52	Analog Input Address 31, Channel 4															

Table 5.46

VBG-EP1-KE5-D Output Data, INT Format, Instance ID: 102

INT	Bit															
	15	14	13	12	11	10	9	8	7	6	5	4	3	2	1	0
0	Node 2/2A				Node 3/3A				0	0	0	0	Node 1/1A			
1	Node 6/6A				Node 7/7A				Node 4/4A				Node 5/5A			
...			
7	Node 30/30A				Node 31/31A				Node 28/28A				Node 29/29A			
8	Node 2B				Node 3B				Reserved				Node 1B			
...			
15	Node 30B				Node 31B				Node 28B				Node 29B			
16	Analog Output Address 27, Channel 1															
17	Analog Output Address 27, Channel 2															
18	Analog Output Address 27, Channel 3															
19	Analog Output Address 27, Channel 4															
20	Analog Output Address 28, Channel 1															
21	Analog Output Address 28, Channel 2															
22	Analog Output Address 28, Channel 3															
23	Analog Output Address 28, Channel 4															
24	Analog Output Address 29, Channel 1															
25	Analog Output Address 29, Channel 2															
26	Analog Output Address 29, Channel 3															
27	Analog Output Address 29, Channel 4															

2023-06

INT	Bit															
	15	14	13	12	11	10	9	8	7	6	5	4	3	2	1	0
28	Analog Output Address 30, Channel 1															
29	Analog Output Address 30, Channel 2															
30	Analog Output Address 30, Channel 3															
31	Analog Output Address 30, Channel 4															
32	Analog Output Address 31, Channel 1															
33	Analog Output Address 31, Channel 2															
34	Analog Output Address 31, Channel 3															
35	Analog Output Address 31, Channel 4															

Table 5.47

VBG-EP1-KE5-DMD Input Data, INT Format, Instance ID: 105

INT	Bit															
	15	14	13	12	11	10	9	8	7	6	5	4	3	2	1	0
Network 1																
0	Node 2/2A				Node 3/3A				F3	F2	F1	F0	Node 1/1A			
1	Node 6/6A				Node 7/7A				Node 4/4A				Node 5/5A			
...			
7	Node 30/30A				Node 31/31A				Node 28/28A				Node 29/29A			
8	Node 2B				Node 3B				Reserved				Node 1B			
...			
15	Node 30B				Node 31B				Node 28B				Node 29B			
Network 2																
16	Node 2/2A				Node 3/3A				F3	F2	F1	F0	Node 1/1A			
17	Node 6/6A				Node 7/7A				Node 4/4A				Node 5/5A			
...			
23	Node 30/30A				Node 31/31A				Node 28/28A				Node 29/29A			
24	Node 2B				Node 3B				Reserved				Node 1B			
...			
31	Node 30B				Node 31B				Node 28B				Node 29B			
Network 1																
32	Offline	Power fail	In Normal Operation	Cfg mode act	Auto Adr avail	Auto Adr not Pos	LDS.0	Cfg error	0	0	0	Earth Fault	0	0	0	Peripheral Fault
33	LDS															
	15A	14A	13A	12A	11A	10A	9A	8A	7A	6A	5A	4A	3A	2A	1A	0
34	LDS															
	31A	30A	29A	28A	27A	26A	25A	24A	23A	22A	21A	20A	19A	18A	17A	16A

2023-06

INT	Bit															
	15	14	13	12	11	10	9	8	7	6	5	4	3	2	1	0
35	LDS															
	15B	14B	13B	12B	11B	10B	9B	8B	7B	6B	5B	4B	3B	2B	1B	0
36	LDS															
	31B	30B	29B	28B	27B	26B	25B	24B	23B	22B	21B	20B	19B	18B	17B	16B
37	LPS															
	15A	14A	13A	12A	11A	10A	9A	8A	7A	6A	5A	4A	3A	2A	1A	0
38	LPS															
	31A	30A	29A	28A	27A	26A	25A	24A	23A	22A	21A	20A	19A	18A	17A	16A
39	LPS															
	15B	14B	13B	12B	11B	10B	9B	8B	7B	6B	5B	4B	3B	2B	1B	0
40	LPS															
	31B	30B	29B	28B	27B	26B	25B	24B	23B	22B	21B	20B	19B	18B	17B	16B
41	LAS															
	15A	14A	13A	12A	11A	10A	9A	8A	7A	6A	5A	4A	3A	2A	1A	0
42	LAS															
	31A	30A	29A	28A	27A	26A	25A	24A	23A	22A	21A	20A	19A	18A	17A	16A
43	LAS															
	15B	14B	13B	12B	11B	10B	9B	8B	7B	6B	5B	4B	3B	2B	1B	0
44	LAS															
	31B	30B	29B	28B	27B	26B	25B	24B	23B	22B	21B	20B	19B	18B	17B	16B
45	LPF															
	15A	14A	13A	12A	11A	10A	9A	8A	7A	6A	5A	4A	3A	2A	1A	0
46	LPF															
	31A	30A	29A	28A	27A	26A	25A	24A	23A	22A	21A	20A	19A	18A	17A	16A
47	LPF															
	15B	14B	13B	12B	11B	10B	9B	8B	7B	6B	5B	4B	3B	2B	1B	0
48	LPF															
	31B	30B	29B	28B	27B	26B	25B	24B	23B	22B	21B	20B	19B	18B	17B	16B
Network 2																
49	Offline	Power fail	In Normal Operation	Cfg mode act	Auto Adr avail	Auto Adr not Pos	LDS:0	Cfg error	0	0	0	Earth Fault	0	0	0	Peripheral Fault
50	LDS															
	15A	14A	13A	12A	11A	10A	9A	8A	7A	6A	5A	4A	3A	2A	1A	0
51	LDS															
	31A	30A	29A	28A	27A	26A	25A	24A	23A	22A	21A	20A	19A	18A	17A	16A
52	LDS															
	15B	14B	13B	12B	11B	10B	9B	8B	7B	6B	5B	4B	3B	2B	1B	0

90-2020

INT	Bit															
	15	14	13	12	11	10	9	8	7	6	5	4	3	2	1	0
53	LDS															
	31B	30B	29B	28B	27B	26B	25B	24B	23B	22B	21B	20B	19B	18B	17B	16B
54	LPS															
	15A	14A	13A	12A	11A	10A	9A	8A	7A	6A	5A	4A	3A	2A	1A	0
55	LPS															
	31A	30A	29A	28A	27A	26A	25A	24A	23A	22A	21A	20A	19A	18A	17A	16A
56	LPS															
	15B	14B	13B	12B	11B	10B	9B	8B	7B	6B	5B	4B	3B	2B	1B	0
57	LPS															
	31B	30B	29B	28B	27B	26B	25B	24B	23B	22B	21B	20B	19B	18B	17B	16B
58	LAS															
	15A	14A	13A	12A	11A	10A	9A	8A	7A	6A	5A	4A	3A	2A	1A	0
59	LAS															
	31A	30A	29A	28A	27A	26A	25A	24A	23A	22A	21A	20A	19A	18A	17A	16A
60	LAS															
	15B	14B	13B	12B	11B	10B	9B	8B	7B	6B	5B	4B	3B	2B	1B	0
61	LAS															
	31B	30B	29B	28B	27B	26B	25B	24B	23B	22B	21B	20B	19B	18B	17B	16B
62	LPF															
	15A	14A	13A	12A	11A	10A	9A	8A	7A	6A	5A	4A	3A	2A	1A	0
63	LPF															
	31A	30A	29A	28A	27A	26A	25A	24A	23A	22A	21A	20A	19A	18A	17A	16A
64	LPF															
	15B	14B	13B	12B	11B	10B	9B	8B	7B	6B	5B	4B	3B	2B	1B	0
65	LPF															
	31B	30B	29B	28B	27B	26B	25B	24B	23B	22B	21B	20B	19B	18B	17B	16B
Network 1																
66	Analog Input Address 27, Channel 1															
67	Analog Input Address 27, Channel 2															
68	Analog Input Address 27, Channel 3															
69	Analog Input Address 27, Channel 4															
70	Analog Input Address 28, Channel 1															
71	Analog Input Address 28, Channel 2															
72	Analog Input Address 28, Channel 3															
73	Analog Input Address 28, Channel 4															
74	Analog Input Address 29, Channel 1															
75	Analog Input Address 29, Channel 2															
76	Analog Input Address 29, Channel 3															
77	Analog Input Address 29, Channel 4															
78	Analog Input Address 30, Channel 1															
79	Analog Input Address 30, Channel 2															

2023-06

INT	Bit															
	15	14	13	12	11	10	9	8	7	6	5	4	3	2	1	0
80	Analog Input Address 30, Channel 3															
81	Analog Input Address 30, Channel 4															
82	Analog Input Address 31, Channel 1															
83	Analog Input Address 31, Channel 2															
84	Analog Input Address 31, Channel 3															
85	Analog Input Address 31, Channel 4															
Network 2																
86	Analog Input Address 27, Channel 1															
87	Analog Input Address 27, Channel 2															
88	Analog Input Address 27, Channel 3															
89	Analog Input Address 27, Channel 4															
90	Analog Input Address 28, Channel 1															
91	Analog Input Address 28, Channel 2															
92	Analog Input Address 28, Channel 3															
93	Analog Input Address 28, Channel 4															
94	Analog Input Address 29, Channel 1															
95	Analog Input Address 29, Channel 2															
96	Analog Input Address 29, Channel 3															
97	Analog Input Address 29, Channel 4															
98	Analog Input Address 30, Channel 1															
99	Analog Input Address 30, Channel 2															
100	Analog Input Address 30, Channel 3															
101	Analog Input Address 30, Channel 4															
102	Analog Input Address 31, Channel 1															
103	Analog Input Address 31, Channel 2															
104	Analog Input Address 31, Channel 3															
105	Analog Input Address 31, Channel 4															

Table 5.48

VBG-EP1-KE5-DMD Output Data, INT Format, Instance ID: 102

INT	Bit															
	15	14	13	12	11	10	9	8	7	6	5	4	3	2	1	0
Network 1																
0	Node 2/2A				Node 3/3A				-	-	-	-	Node 1/1A			
1	Node 6/6A				Node 7/7A				Node 4/4A				Node 5/5A			
...			
7	Node 30/30A				Node 31/31A				Node 28/28A				Node 29/29A			
8	Node 2B				Node 3B				Reserved				Node 1B			
...			
15	Node 30B				Node 31B				Node 28B				Node 29B			
Network 2																

2023-06

INT	Bit															
	15	14	13	12	11	10	9	8	7	6	5	4	3	2	1	0
16	Node 2/2A				Node 3/3A				-	-	-	-	Node 1/1A			
17	Node 6/6A				Node 7/7A				Node 4/4A				Node 5/5A			
...			
23	Node 30/30A				Node 31/31A				Node 28/28A				Node 29/29A			
24	Node 2B				Node 3B				Reserved				Node 1B			
...			
31	Node 30B				Node 31B				Node 28B				Node 29B			
Network 1																
32	Analog Output Address 27, Channel 1															
33	Analog Output Address 27, Channel 2															
34	Analog Output Address 27, Channel 3															
35	Analog Output Address 27, Channel 4															
36	Analog Output Address 28, Channel 1															
37	Analog Output Address 28, Channel 2															
38	Analog Output Address 28, Channel 3															
39	Analog Output Address 28, Channel 4															
40	Analog Output Address 29, Channel 1															
41	Analog Output Address 29, Channel 2															
42	Analog Output Address 29, Channel 3															
43	Analog Output Address 29, Channel 4															
44	Analog Output Address 30, Channel 1															
45	Analog Output Address 30, Channel 2															
46	Analog Output Address 30, Channel 3															
47	Analog Output Address 30, Channel 4															
48	Analog Output Address 31, Channel 1															
49	Analog Output Address 31, Channel 2															
50	Analog Output Address 31, Channel 3															
51	Analog Output Address 31, Channel 4															
Network 2																
52	Analog Output Address 27, Channel 1															
53	Analog Output Address 27, Channel 2															
54	Analog Output Address 27, Channel 3															
55	Analog Output Address 27, Channel 4															
56	Analog Output Address 28, Channel 1															
57	Analog Output Address 28, Channel 2															
58	Analog Output Address 28, Channel 3															
59	Analog Output Address 28, Channel 4															
60	Analog Output Address 29, Channel 1															
61	Analog Output Address 29, Channel 2															
62	Analog Output Address 29, Channel 3															
63	Analog Output Address 29, Channel 4															

INT	Bit															
	15	14	13	12	11	10	9	8	7	6	5	4	3	2	1	0
64	Analog Output Address 30, Channel 1															
65	Analog Output Address 30, Channel 2															
66	Analog Output Address 30, Channel 3															
67	Analog Output Address 30, Channel 4															
68	Analog Output Address 31, Channel 1															
69	Analog Output Address 31, Channel 2															
70	Analog Output Address 31, Channel 3															
71	Analog Output Address 31, Channel 4															

Table 5.49

Diagnostic Bits Flag

Error	Designation	Description
F0	Configuration errors	0 = Configuration OK 1 = Configuration error present
F1	AS-Interface Power Fail	0 = AS-Interface voltage OK 1 = AS-Interface voltage missing/too low
F2	Peripheral faults	0 = Peripheral OK 1 = Peripheral fault present
F3	Configuration mode active	0 = Protected mode 1 = Configuration mode

Table 5.50

Diagnostic Bits

Designation	Description
Peripheral fault	0 = No activated node reports a peripheral fault 1 = At least one node reports a peripheral fault
Earth fault	0 = No short-circuit to ground 1 = Short-circuit to ground detected; AS-Interface network + or - is grounded
Configuration error	0 = There is no configuration error 1 = At least one configuration error detected
LDS.0	0 = No AS-Interface node with address 0 found 1 = AS-Interface node with address 0 found
Auto address assignment not possible	0 = The conditions for automatic address assignment are currently met 1 = Automatic address assignment is currently not possible
Auto address assignment available	0 = Automatic address assignment is disabled 1 = Automatic address assignment as soon as the conditions are met
Configuration mode active	0 = AS-Interface gateway is in protected mode 1 = AS-Interface gateway is in configuration mode
Not in normal operation	0 = AS-Interface gateway is in the normal operating state 1 = AS-Interface gateway not in the normal operating state (e.g., startup phase)

Designation	Description
AS-Interface power fail	0 = AS-Interface mains voltage OK 1 = AS-Interface mains voltage too low or power failure during data transfer on the AS-Interface network
AS-Interface master offline	0 = AS-Interface gateway is online 1 = AS-Interface gateway is offline

Table 5.51

List of Detected LDS Nodes

The gateway provides a list of detected nodes for each AS-Interface network. This indicates whether a network node is detected or not.

- 0 No node detected/present at the specified address
- 1 A node is detected/present at the specified address.

List of Projected LPS Nodes

The gateway provides a list of projected nodes for each AS-Interface network. This indicates whether a device should be present or not.

- 0 No device is expected for the specified address.
- 1 A device must be present at the specified address.

List of Activated LAS Nodes

The gateway provides a list of activated nodes for each AS-Interface network. This indicates whether or not a node is currently exchanging data.

- 0 The node is not activated.
- 1 The node is activated.

List of Peripheral Faults LPF

The gateway provides a list of peripheral faults for each AS-Interface network. This indicates whether or not there is a peripheral fault for each node.

- 0 The node does not have a peripheral fault
- 1 The node sends a peripheral fault diagnostic bit

Illustration of analog process data

If the analog data is mapped with the **DIO Diagnostics AIO** assembly instance, 20 analog channels are reserved for each segment. The default start address for the AS-Interface device is 27 and the number of channels per address is four. You can change the start address and the number of channels in the configuration object.

You can set a start address for each of the inputs, outputs and, network. You can use the "Channel selection" parameter to reduce the number of channels per address so that more addresses can be assigned.

In the configuration object, the start address for each direction and each AS-Interface segment is (Analog_<Direction>_Start_Address_Line <LineNumber>), and the channel selection is (Analog_<Direction>_Channel Selection_Line<LineNumber>).

The channel selection option affects the channels that are available in the AIO of the assembly instance.



Example

If Analog_Input_Start_Address_L1 is set to 10 and the channel selection is 3 = channel 1, 2, then the assignment in VBG-EP1-KE5-DMD Input Data, INT Format, Instance ID: 105 for the analog data is as follows:

Settings

- Analog_Input_Start_Address_L1 -> 10
- Analog_Input_Channel_Selection_Line1 -> channel 1, 2

Result

INT	Assigned AS-Interface device/channel
66	Address 10, channel 1
67	Address 10, channel 2
68	Address 11, channel 1
69	Address 11, channel 2
70	Address 12, channel 1
71	Address 12, channel 2
72	Address 13, channel 1
73	Address 13, channel 2
74	Address 14, channel 1
75	Address 14, channel 2
76	Address 15, channel 1
77	Address 15, channel 2
78	Address 16, channel 1
79	Address 16, channel 2
80	Address 17, channel 1
81	Address 17, channel 2
82	Address 18, channel 1
83	Address 18, channel 2
84	Address 19, channel 1
85	Address 19, channel 2



Note

Analog nodes only use two channels if the device supports extended addressing with A/B addresses.

A addresses are mapped to channel 1+2; B addresses are mapped to channel 3+4.

Configuration Data, Instance ID: 104

Configuration data is available when the AS-Interface diagnostic data is mapped. If the second byte "Use_Activation_Parameter_Config" is set to 1, all parameters listed in the configuration are stored in non-volatile memory. These parameters are only applied when EtherNet/IP Forward is opened or when the gateway is switched on. If used, the gateway sends a reset command and activates the AS-Interface nodes with these new parameters for EtherNet/IP Forward Open or Power Cycle.

VBG-EP1-KE5-D

Byte	Content	Meaning	Value range	Factory setting
0	Configuration_Assembly_Version	Identifier for configuration structure changes	0	0x00
1	Use_Activation_Parameter_Config	If activated, the activation parameters are saved and downloaded in the following bytes	0 = Ignore subsequent activation parameters 1 = Use as current parameter and save as permanent parameter	0x00
2	Activation_Parameter_Line1_1A	Activation parameter for AS-Interface device address 1/1A on AS-Interface segment 1	0x00 - 0x0F	0x0F
...
32	Activation_Parameter_Line1_31A	Activation parameter for AS-Interface device address 31/31A on AS-Interface segment 1	0x00 - 0x0F	0x0F
33	Activation_Parameter_Line1_1B	Activation parameter for AS-Interface device address 1B on AS-Interface segment 1	0x00 - 0x0F	0x0F
...
63	Activation_Parameter_Line1_31B	Activation parameter for AS-Interface device address 31B on AS-Interface segment 1	0x00 - 0x0F	0x0F
64	Analog_Input_Start_Address_Line1	Start address for the analog input data field for segment 1	0 = Standard behavior, address 27 1 – 31 = Start address	0x00
65	Analog_Input_Channel_Selection_Line1	Selection of the analog input channel for segment 1	0 = Standard (all channels 1,2,3,4) 1 = channel 1 2 = channel 2 3 = channel 1, 2 4 = channel 3 5 = channel 1, 3 8 = channel 4 12 = channel 3, 4 15 = channel 1, 2, 3, 4	0x00
66	Analog_Output_Start_Address_Line1	Start address for the analog output data field for segment 1	0 = Standard behavior, address 27 1 – 31 = Start address	0x00
67	Analog_Input_Channel_Selection_Line1	Selection of the analog output channel for segment 1	0 = Standard (all channels 1,2,3,4) 1 = channel 1 2 = channel 2 3 = channel 1, 2 4 = channel 3 5 = channel 1, 3 8 = channel 4 12 = channel 3, 4 15 = channel 1, 2, 3, 4	0x00

Table 5.52

VBG-EP1-KE5-DMD

Byte	Content	Meaning	Value range	Factory setting
0	Configuration assembly version	Identifier for configuration structure changes	0	0x00
1	Use_Activation_Parameter_Config	If activated, the activation parameters are saved and downloaded in the following bytes	0 = Ignore subsequent activation parameters 1 = Use as current parameter and save as permanent parameter	0x00
2	Activation_Parameter_Line1_1A	Activation parameter for AS-Interface device address 1/1A on AS-Interface segment 1	0x00 - 0x0F	0x0F
...
32	Activation_Parameter_Line1_31A	Activation parameter for AS-Interface device address 31/31A on AS-Interface segment 1	0x00 - 0x0F	0x0F
33	Activation_Parameter_Line1_1B	Activation parameter for AS-Interface device address 1B on AS-Interface segment 1	0x00 - 0x0F	0x0F
...
63	Activation_Parameter_Line1_31B	Activation parameter for AS-Interface device address 31B on AS-Interface segment 1	0x00 - 0x0F	0x0F
64	Activation_Parameter_Line2_1A	Activation parameter for AS-Interface device address 1/1A on AS-Interface segment 2	0x00 - 0x0F	0x0F
...
94	Activation_Parameter_Line2_31A	Activation parameter for AS-Interface device address 31/31A on AS-Interface segment 2	0x00 - 0x0F	0x0F
95	Activation_Parameter_Line2_1B	Activation parameter for AS-Interface device address 1B on AS-Interface segment 2	0x00 - 0x0F	0x0F
...
125	Activation_Parameter_Line2_31B	Activation parameter for AS-Interface device address 31B on AS-Interface segment 2	0x00 - 0x0F	0x0F
126	Analog_Input_Start_Address_Line1	Start address for the analog input data field for segment 1	0 = Standard behavior, address 27 1 – 31 = Start address	27

Byte	Content	Meaning	Value range	Factory setting
127	Analog_Input_Channel_Selection_Line1	Selection of the analog input channel for segment 1	0 = Standard (all channels 1,2,3,4) 1 = channel 1 2 = channel 2 3 = channel 1, 2 4 = channel 3 5 = channel 1, 3 8 = channel 4 12 = channel 3, 4 15 = channel 1, 2, 3, 4	15
128	Analog_Output_Start_Address_Line1	Start address for the analog output data field for segment 1	0 = Standard behavior, address 27 1 – 31 = Start address	27
129	Analog_Input_Channel_Selection_Line1	Selection of the analog output channel for segment 1	0 = Standard (all channels 1,2,3,4) 1 = channel 1 2 = channel 2 3 = channel 1, 2 4 = channel 3 5 = channel 1, 3 8 = channel 4 12 = channel 3, 4 15 = channel 1, 2, 3, 4	15
130	Analog_Input_Start_Address_Line2	Start address for the analog input data field for segment 2	0 = Standard behavior, address 27 1 – 31 = Start address	27
131	Analog_Input_Channel_Selection_Line2	Selection of the analog input channel for segment 2	0 = Standard (all channels 1,2,3,4) 1 = channel 1 2 = channel 2 3 = channel 1, 2 4 = channel 3 5 = channel 1, 3 8 = channel 4 12 = channel 3, 4 15 = channel 1, 2, 3, 4	15
132	Analog_Output_Start_Address_Line2	Start address for the analog output data field for segment 2	0 = Standard behavior, address 27 1 – 31 = Start address	27
133	Analog_Output_Channel_Selection_Line2	Selection of the analog output channel for segment 2	0 = Standard (all channels 1,2,3,4) 1 = channel 1 2 = channel 2 3 = channel 1, 2 4 = channel 3 5 = channel 1, 3 8 = channel 4 12 = channel 3, 4 15 = channel 1, 2, 3, 4	15

Table 5.53

5.3.4 EtherNet/IP Class 3 Objects

Objects can be read or written (Get or Set). This enables acyclic communication with the AS-Interface for identification, resetting, or configuration.

Identity object 01_{hex}, 1 instance

Class attributes for the identity object 01_{hex}

Attribute ID	Name	Data Type	Data value	Access
1	Revision	UINT	2	Get
2	Max Instances	UINT	1	Get
3	Number of Instances	UINT	7	Get

Table 5.54

Instance Attributes for the Identity Object 01_{hex}

Attribute ID	Name	Data Type	Data value	Access
1	Vendor ID	UINT	57	Get
2	Device Type	UINT	12	Get
3	Product Code	UINT	392 [VBG-EP1-KE5-D] 393 [VBG-EP1-KE5-DMD]	Get
4	Revision	UINT USINT	Major revision Minor revision	Get
5	Status	WORD	See EtherNet/IP specification	Get
6	Serial number	USINT STRING	Length of character string Serial number	Get
7	Product Name	USINT STRING	Length of character string Model number	Get

Table 5.55

Common Services for Object 01_{hex}

Service code	Implemented in class	Implemented in instance	Service name
1 _{hex}	Yes	Yes	Get_Attribute_All
5 _{hex}	No	Yes	Reset
0E _{hex}	Yes	Yes	Get_Attribute_Single
4B _{hex}	No	Yes	Flash_LED

Table 5.56



Example

Reset

Data to be sent: source data length 1 byte

0 = Restart

1 = Reset to standard. Resets password, EtherNet/IP, and ASi configurations

Data to be received once the message has been completed: none

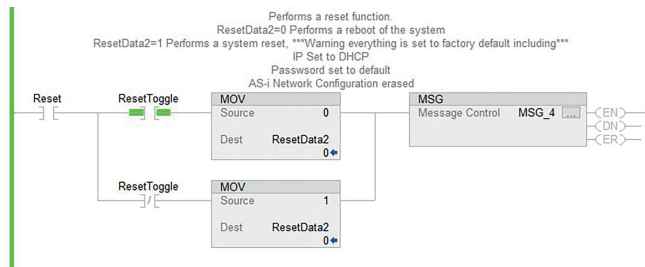

Figure 5.36

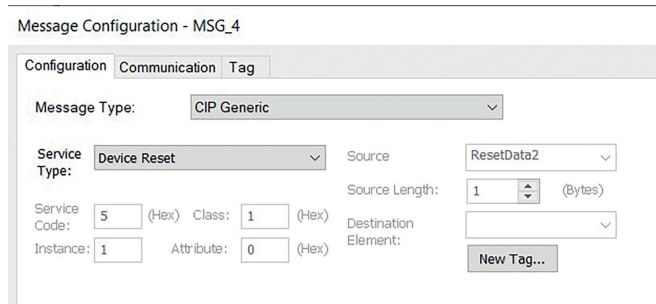

Figure 5.37

Diagnostic and Configuration Object 64_{hex}

The object makes it possible to read and write both the current and permanent parameters.

Permanent parameter: This parameter is stored in a non-volatile memory and is used each time the node is activated after a power cycle.

Current parameter: This is the current parameter used by the node. The settings for the current parameter are written directly to the node. The response to the write operation is the parameter echo, which comes directly from the AS-Interface node and does not have to be identical to the current parameter. This parameter is not stored in a non-volatile memory. The permanent parameter overwrites this value the next time the node is activated after the power cycle. It is only possible to write this parameter when the nodes are activated.

The identity object provides identification information and general information about the AS-Interface gateway

Class Attributes for the Object 64_{hex}

Attribute ID	Name	Data type	Data value	Access
1	Revision	UINT	2	Get
2	Max Instances	UINT	1 [VBG-EP1-KE5-D] 2 [VBG-EP1-KE5-DMD]	Get
3	Number of Instances	UINT	1 [VBG-EP1-KE5-D] 2 [VBG-EP1-KE5-DMD]	Get

Table 5.57

2023-06

Instance Attributes for the Object 64_{hex}

Attribute ID	Name	Data type	Data value	Access
1	Actual Parameter	ARRAY OF UINT8 [62]	List of the current parameters of all AS-Interface devices in the AS-Interface network	Get Set
2	Permanent Parameter	ARRAY OF UINT8 [62]	List of permanent parameters of all AS-Interface devices in the AS-Interface network; changes to the permanent parameters are applied the next time the device is switched on.	Get Set

Table 5.58

Service code	Implemented in class	Implemented in instance	Service name
1 _{hex}	Yes	Yes	Get_Attribute_All
0E _{hex}	Yes	Yes	Get_Attribute_Single
10 _{hex}	No	Yes	Set_Attribute_Single
18 _{hex}	No	Yes	Get_Member
19 _{hex}	No	Yes	Set_Member
32 _{hex}	No	Yes	Custom_Service ¹
33 _{hex}	No	Yes	Custom_Service ²
34 _{hex}	No	Yes	Custom Service [Read CTT1 ID String command]
35 _{hex}	No	Yes	Custom Service [Read CTT1 Diagnosis command]
36 _{hex}	No	Yes	Custom Service [Read CTT1 parameter string command]
37 _{hex}	No	Yes	Custom Service [Write CTT1 parameter string command]
38 _{hex}	No	Yes	Custom Service [Execute CTT2 string command]
39 _{hex}	No	Yes	Custom Service [Read CTT1/2 string command response]

Table 5.59

- 1. Write parameters and read echo
- 2. Set motor control (G20) config



Example

Reading All Current Parameters

Data to be sent: none

Data to be received once the message has been completed: 62 bytes. Use the "parameter" UDT provided by Pepperl+Fuchs to easily separate parameters.

Parameters	(...)	PF_Parameters
Parameters.ADR_1A	1 Decimal	SINT
Parameters.ADR_2A	7 Decimal	SINT
Parameters.ADR_3A	4 Decimal	SINT
Parameters.ADR_4A	4 Decimal	SINT
Parameters.ADR_5A	5 Decimal	SINT
Parameters.ADR_6A	6 Decimal	SINT
Parameters.ADR_7A	7 Decimal	SINT
Parameters.ADR_8A	8 Decimal	SINT
Parameters.ADR_9A	9 Decimal	SINT
Parameters.ADR_10A	10 Decimal	SINT
Parameters.ADR_11A	15 Decimal	SINT
Parameters.ADR_12A	15 Decimal	SINT
Parameters.ADR_13A	15 Decimal	SINT
Parameters.ADR_14A	15 Decimal	SINT
Parameters.ADR_15A	15 Decimal	SINT
Parameters.ADR_16A	15 Decimal	SINT

Figure 5.38

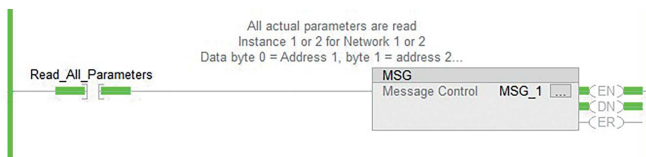

Figure 5.39

Message Configuration - MSG_1

Configuration* Communication Tag

Message Type: CIP Generic

Service Type: Get Attribute Single Source: []

Service Code: e (Hex) Class: 64 (Hex) Source Length: 0 (Bytes)

Instance: 1 Attribute: 3 (Hex) Destination Element: Parameters

Network 1

Figure 5.40



Example

Writing Current Parameters

Data to be sent: 2 bytes

Byte 0 = Address for setting the parameter

Byte 1 = Parameter to be set

Param_Send_Data	(...)	Decimal	SINT[2]	
Param_Send_Data[0]	1	Decimal	SINT	Address
Param_Send_Data[1]	1	Decimal	SINT	Parameter

Figure 5.41

Data to be received once the message has been completed: 1 byte

Byte 0 = Parameter echo

Param_Echo	1	Decimal	SINT	
------------	---	---------	------	--

Figure 5.42

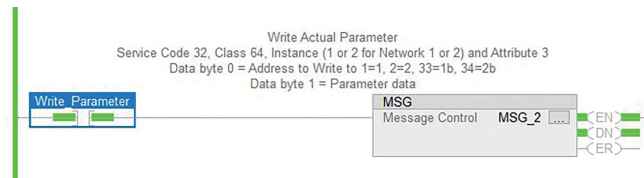

Figure 5.43

Message Configuration - MSG_2

Configuration* Communication Tag

Message Type: CIP Generic

Service Type: Custom Source: Param_Send_Data

Source Length: 2 (Bytes)

Service Code: 32 (Hex) Class: 64 (Hex) Destination Element: Param_Echo

Instance: 1 Attribute: 3 (Hex)

Network 1

Figure 5.44



Example

Reading All Permanent Parameters

Data to be sent: none

Data to be received once the message has been completed: 62 bytes. Use the "parameter" UDT provided by Pepperl+Fuchs to easily separate parameters.

Parameters	(...)	PF_Parameters
Parameters.ADR_1A	1 Decimal	SINT
Parameters.ADR_2A	7 Decimal	SINT
Parameters.ADR_3A	4 Decimal	SINT
Parameters.ADR_4A	4 Decimal	SINT
Parameters.ADR_5A	5 Decimal	SINT
Parameters.ADR_6A	6 Decimal	SINT
Parameters.ADR_7A	7 Decimal	SINT
Parameters.ADR_8A	8 Decimal	SINT
Parameters.ADR_9A	9 Decimal	SINT
Parameters.ADR_10A	10 Decimal	SINT
Parameters.ADR_11A	15 Decimal	SINT
Parameters.ADR_12A	15 Decimal	SINT
Parameters.ADR_13A	15 Decimal	SINT
Parameters.ADR_14A	15 Decimal	SINT
Parameters.ADR_15A	15 Decimal	SINT
Parameters.ADR_16A	15 Decimal	SINT

Figure 5.45

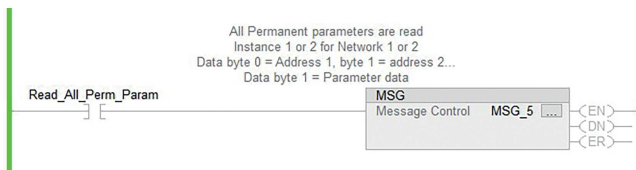

Figure 5.46

Message Configuration - MSG_5

Configuration Communication Tag

Message Type: CIP Generic

Service Type: Get Attribute Single Source: []

Service Code: e (Hex) Class: 64 (Hex) Source Length: 0 (Bytes)

Instance: 1 Attribute: 4 (Hex) Destination Element: Parameters

Network 1

Figure 5.47



Example

Setting All Permanent Parameters

Data to be sent: 62 bytes. Use the "parameter" UDT provided by Pepperl+Fuchs to easily separate parameters

Parameters	(...)	PF_Parameters
Parameters.ADR_1A	1 Decimal	SINT
Parameters.ADR_2A	7 Decimal	SINT
Parameters.ADR_3A	4 Decimal	SINT
Parameters.ADR_4A	4 Decimal	SINT
Parameters.ADR_5A	5 Decimal	SINT
Parameters.ADR_6A	6 Decimal	SINT
Parameters.ADR_7A	7 Decimal	SINT
Parameters.ADR_8A	8 Decimal	SINT
Parameters.ADR_9A	9 Decimal	SINT
Parameters.ADR_10A	10 Decimal	SINT
Parameters.ADR_11A	15 Decimal	SINT
Parameters.ADR_12A	15 Decimal	SINT
Parameters.ADR_13A	15 Decimal	SINT
Parameters.ADR_14A	15 Decimal	SINT
Parameters.ADR_15A	15 Decimal	SINT
Parameters.ADR_16A	15 Decimal	SINT

Figure 5.48

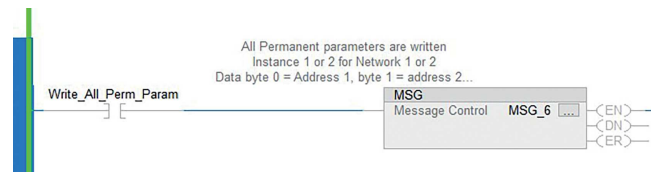

Figure 5.49

Message Configuration - MSG_6

Configuration* Communication* Tag

Message Type: CIP Generic

Service Type: Set Attribute Single Source: Parameters

Service Code: 10 (Hex) Class: 64 (Hex) Source Length: 62 (Bytes)

Instance: 1 Attribute: 4 (Hex) Destination Element:

Network 1

Figure 5.50

Command and Response Data for CTT1/2 Commands

Command/service code	Usable data		Response	
	Header	Data	Header	Data
Read ID String (0x34)	Device address	-	Command_Status	Character string
Read Diagnosis (0x35)	Device address	-	Command_Status	Character string
Read parameter string (0x36)	Device address	-	Command_Status	Character string
Write parameter string (0x37)	Device address	Character string	Command_Status	-

Command/service code	Usable data		Response	
	Header	Data	Header	Data
CTT2 string command (0x38)	Device address	Character string	Command_Status	-
Read CTT1/2 Response	-	-	Command_Status	Response 1

Table 5.60

1. Response contains service code + device address + character string

Command_Status

Code	Description
0x00	OK
0x02	busy
0x1F	Error

Table 5.61



Example

Reading the CTT2 Character String from a Safety Monitor

Example of sending the CTT2 command and getting a response. Two message instructions are required. One is for sending the command (service code 38) and the second is for retrieving the response (service code 39).

Instance: 1 or 2 for segment 1 or 2

Attribute: always 0

4 data bytes are sent as the CTT2 command. These bytes contain the address, the command, the object, and the length. If the received length is shorter than the requested length, the data is truncated.

ReadSafetyDiagnostics	{...}	CTT2Command	
ReadSafetyDiagnostics.Address	27 Decimal	SINT	1-31=1A-31A or 32-62= 31B-62B
ReadSafetyDiagnostics.Command	18 Decimal	SINT	18=Read Vendor Specific Object
ReadSafetyDiagnostics.Object	7 Decimal	SINT	
ReadSafetyDiagnostics.Length	16#ff Hex	SINT	

Figure 5.51

Address: AS-Interface address for reading the character string.

Command: CTT2 command

code	command/response	Data
0 _{Dec}	Get cyclic data from slave	followed by 1...8 byte of data (mandatory only if data exists)
1 _{Dec}	Put cyclic data to slave	followed by 1...8 byte of data (mandatory only if data exists)
16 _{Dec}	acyclic standard read service request	followed by index, length
80 _{Dec}	acyclic standard read service response	followed by data
144 _{Dec}	acyclic standard read service response not ok	followed by standard error code
18 _{Dec}	acyclic Vendor specific read service request	followed by index, length
82 _{Dec}	acyclic Vendor specific read service response	followed by data
146 _{Dec}	acyclic Vendor specific read service response not ok	followed by standard error code
17 _{Dec}	acyclic standard write service request	followed by index, length and data
81 _{Dec}	acyclic standard write service response	
145 _{Dec}	acyclic standard write service response not ok	followed by standard error code
19 _{Dec}	acyclic Vendor specific write service request	followed by index, length and data
83 _{Dec}	acyclic Vendor specific write service response	
147 _{Dec}	acyclic Vendor specific write service response not ok	followed by standard error code

Figure 5.52

Object: specific to a CTT2 device. Refer to the datasheet/manual of the device to see which objects are supported.

7 - Read diagnostic data, sorted by device index

8 - Read diagnostic data, sorted by diagnostic index

See the safety monitor manual for additional options.

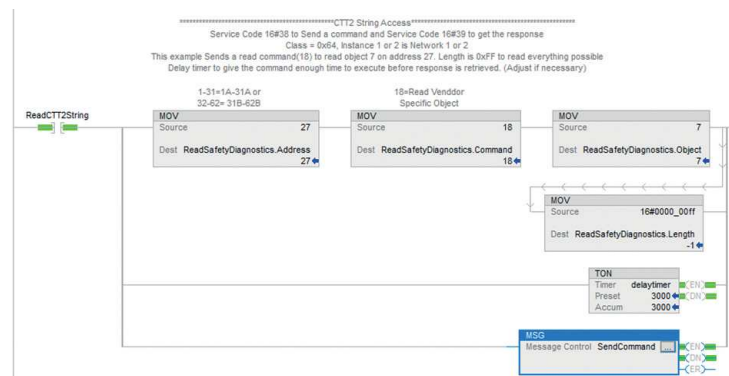

Figure 5.53

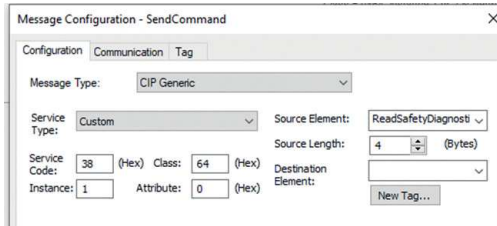

Figure 5.54



Figure 5.55

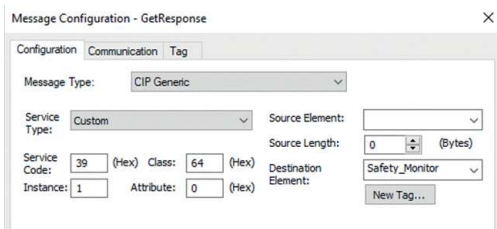

Figure 5.56

Object Name	Address	Object Type	Description
Safety_Monitor	[...]	PF_Safety_Monit...	
Safety_Monitor.NA	55 Decimal	SINT	Service Code string request came from
Safety_Monitor.NA1	27 Decimal	SINT	Address string came from
Safety_Monitor.NA2	82 Decimal	SINT	
Safety_Monitor.Status	1 Decimal	SINT	Bit 0=Mode(D-config, 1=protect) Bit 4 Status S12 Bit 5 Status S21 Bit 6 Status S32 Bit 7 Status S41
Safety_Monitor.OSSD_2_1	70 Decimal	SINT	
Safety_Monitor.OSSD_4_3	102 Decimal	SINT	
Safety_Monitor.OSSD_6_5	102 Decimal	SINT	
Safety_Monitor.OSSD_8_7	102 Decimal	SINT	
Safety_Monitor.OSSD_10_9	102 Decimal	SINT	
Safety_Monitor.OSSD_12_11	102 Decimal	SINT	
Safety_Monitor.OSSD_14_13	102 Decimal	SINT	
Safety_Monitor.OSSD_16_15	102 Decimal	SINT	
Safety_Monitor.Device_Index_Present	[...] Decimal	SINT[32]	Indexes that are present from 0 to 255
Safety_Monitor.Device_Index_Color	[...] Decimal	SINT[128]	Two indexes per byte, bits 0-3 device 1, bits 4-7 device 2

Figure 5.57

This Add-on uses the string commands to read diagnostics from a safety monitor.
 Example is to Address 27 on network 1. Two objects are possible
 Object 7 = Diagnostic Colors by Device Index
 Object 8 = Diagnostic Colors by Diagnostics Index

Device Colors 0 = On/Flash, 1=Green Flashing, 2=Flashing, 3=Yellow Flashing, 4=Red/Stopped, 5=Red Flashing, 6=Gray/Off, 7=index not used

Reads diagnostics from a safety monitor on a VBg-EPI-KE5...

Figure 5.58



Example

Configuring the Deceleration or Acceleration Ramp on a G20 Motor Control Module

Data to be sent: 2 bytes

Byte 0 = Address for setting the configuration

Byte 1 = Configuration 0 to be set

Byte 2 ... 16 = Configuration 1 to be set ... 15, optional

Param_Send_Data	(...)	Decimal	SINT[2]	
Param_Send_Data[0]	1	Decimal	SINT	Address
Param_Send_Data[1]	1	Decimal	SINT	Config 0

Figure 5.59

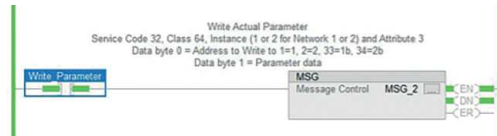

Figure 5.60

Message Configuration - MSG_2

Configuration* Communication Tag

Message Type: CIP Generic

Service Type: Custom Source: Param_Send_Data

Service Code: 32 (Hex) Class: 64 (Hex) Source Length: 2 (Bytes)

Instance: 1 Attribute: 3 (Hex) Destination Element:

Network 1

Figure 5.61

6 Operation

6.1 Push Button

You can use the push button to save the current configuration of one or both AS-Interface segments directly at the gateway and to reset the gateway to the factory setting.

You can switch the fieldbus protocol.

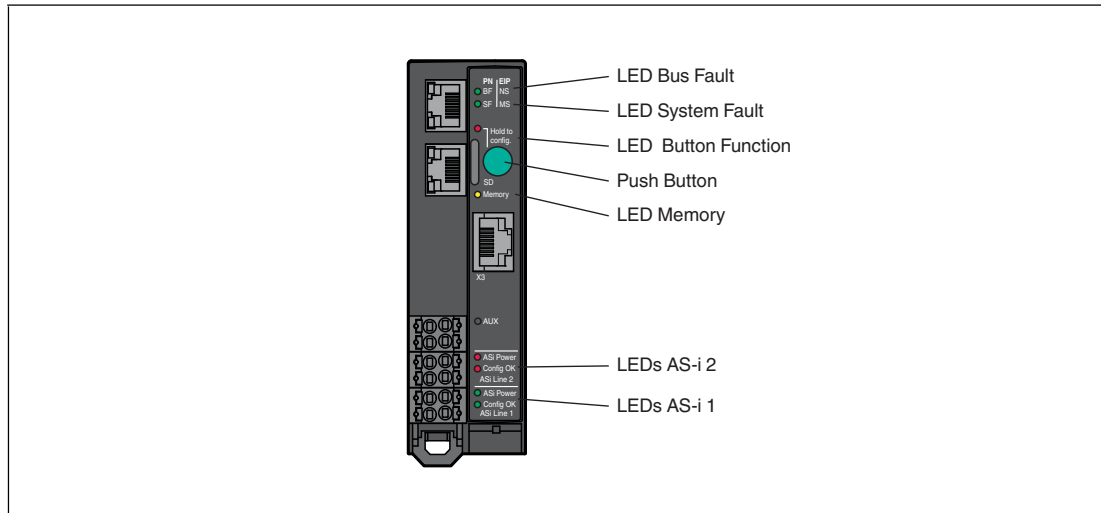

Figure 6.1



Saving the Configuration and Switching to Protected Mode

This feature allows you to save the current configuration of the ASi networks to non-volatile memory and change the operating mode of the selected ASi network to protected mode.

1. Press and hold the push button for at least five seconds.
 - ↳ The LEDs for ASi line 1 flash yellow.
2. Store the current configuration in segment 1 by pressing the push button for at least five seconds.
 - ↳ When the configuration is saved, the LEDs for ASi line 1 flash green for five seconds.
 - ↳ If the configuration has not been saved, the LEDs for ASi line 1 flash red for five seconds.
3. To switch to segment 2, briefly press the push button.
 - ↳ The LEDs for ASi line 2 flash yellow.
4. Store the current configuration in segment 2 by pressing the push button for at least five seconds.
 - ↳ When the configuration is saved, the LEDs for ASi line 2 flash green for five seconds.
 - ↳ If the configuration has not been saved, the LEDs for ASi line 2 flash for five seconds.
5. To switch to segments 1 and 2 at the same time, short-press the push button twice.
 - ↳ The LEDs for ASi line 1 and ASi line 2 flash yellow.
6. Store the current configuration in segments 1 and 2 by pressing the push button for at least five seconds.
 - ↳ If the configuration has been stored, the Memory LED lights up green.
 - ↳ If the configuration has not been stored, the Memory LED lights up red.

**Note**

The device exits the menu after five seconds without any input.

**Switching the Fieldbus Protocol**

A new gateway is always in PROFINET mode. The push button can be used to switch the fieldbus protocol to EtherNet/IP and back to PROFINET. Please note that switching the fieldbus mode will cause the gateway to restart and will reset the fieldbus configuration.

1. Press and hold the push button for at least five seconds.
 - ↳ The LEDs for ASi line 1 flash yellow.
2. **VBG-EP1-KE5-DMD**: Short-press the push button four times for EtherNet/IP or short-press three times for PROFINET.
3. **VBG-EP1-KE5-D**: Short-press the push button twice for EtherNet/IP or short-press once for PROFINET.
 - ↳ The SF/MS LED flashes.
4. Press and hold the push button for at least five seconds.
 - ↳ The LEDs for ASi line 1 and ASi line 2 flash.
 - ↳ The gateway switches to EtherNet/IP mode
5. Switch back to PROFINET mode by repeating steps 1–3.

**Factory Reset**

This function resets the gateway to the state in which it was delivered. The function includes the web server password, the fieldbus configuration, the ASi configuration, and the SD card.

1. With the gateway and power supply switched off, press and hold the push button.
2. Switch on the power supply at the "ASi line 1" connection.
 - ↳ When the LED start sequence has finished, the "SF/MS" LED flashes yellow.
3. Release the push button.
4. Press the push button for at least five seconds and then release it.
 - ↳ The gateway will reset to the factory setting when it restarts.

**Note**

- Do not interrupt the power supply during the factory reset.
- The device exits the menu after five seconds without any input and restarts.
- If an error occurs during the factory reset, the "Button function" LED flashes red. The device restarts.

**Tip**

To use extensive configuration options and fault analysis, use the web interface. See chapter 6.2.

6.2 Web Interface

The AS-Interface gateway has a web interface that allows you to configure the gateway and run diagnostics.

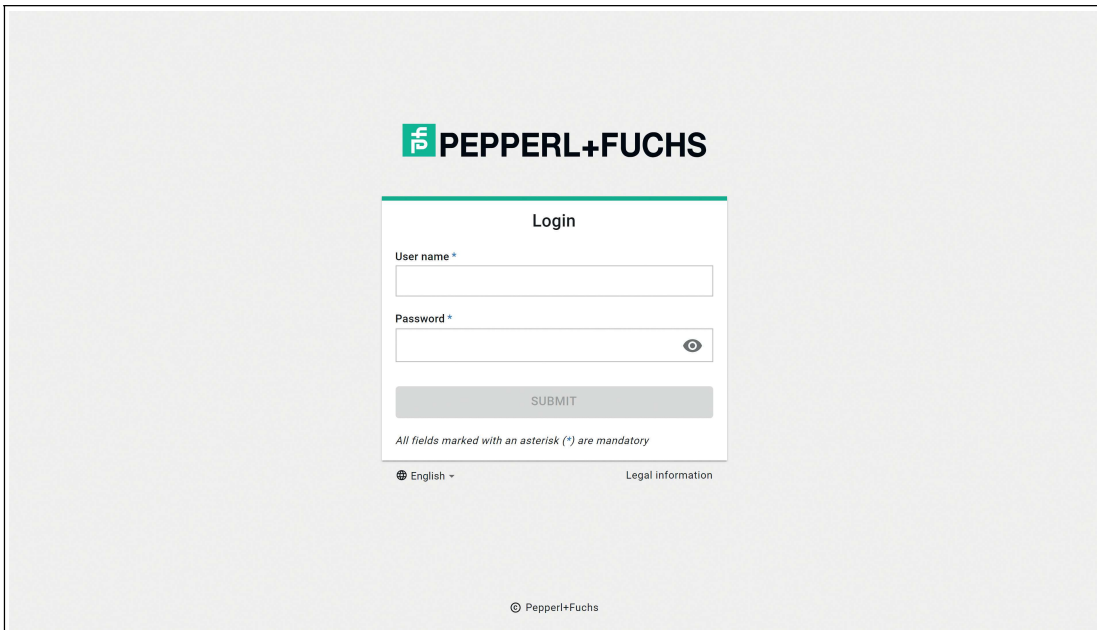

Figure 6.2

The web interface is called up via the fieldbus interface at terminals X1, X2, and X3. See chapter 4.1.3.

Open the web interface with a current web browser, such as Google Chrome, Mozilla Firefox, and Microsoft® Edge.

The web interface is accessed via an HTTP request: `http://<ip - Address>`. The IP address must be configured beforehand via the fieldbus; see chapter 5.2.1.1.

6.2.1 Login



Setting the Language

1. Click on the language selection field in the bottom left.

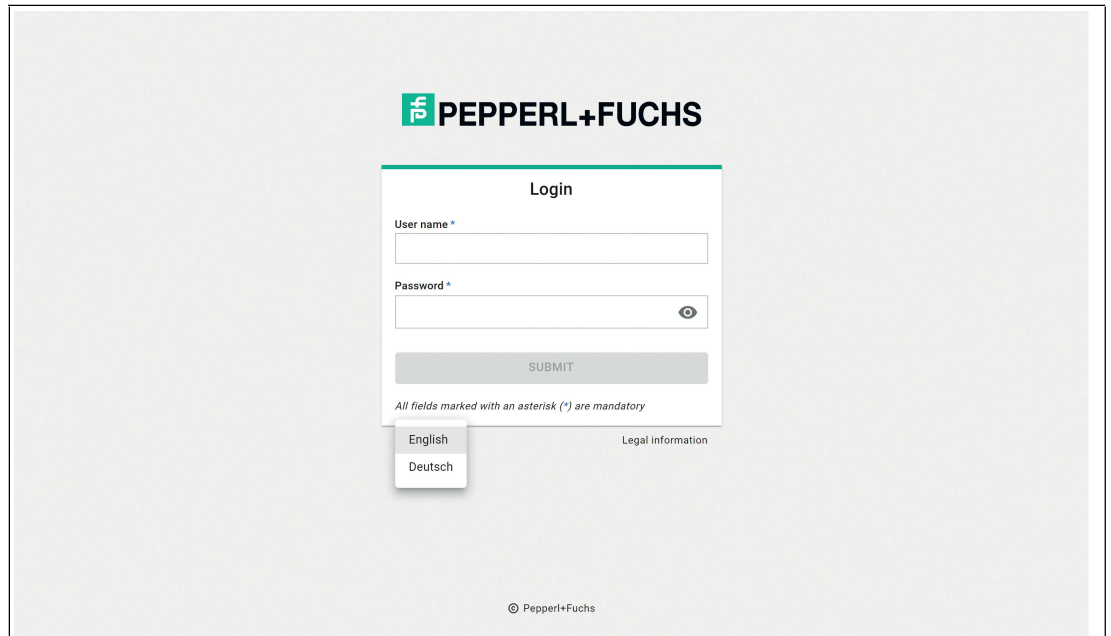

Figure 6.3

2. Click on the language you want the web interface to appear in.
3. You can select German or English.

↳ The selected language is applied to the web interface.



Login



Note

You need a user name and password to launch the web interface. At initial commissioning the user name is "admin." The password can be found on the gateway label.

1. Enter the user name in the "User name" field.
2. Enter the password in the "Password" field.
3. Press the "Submit" button.

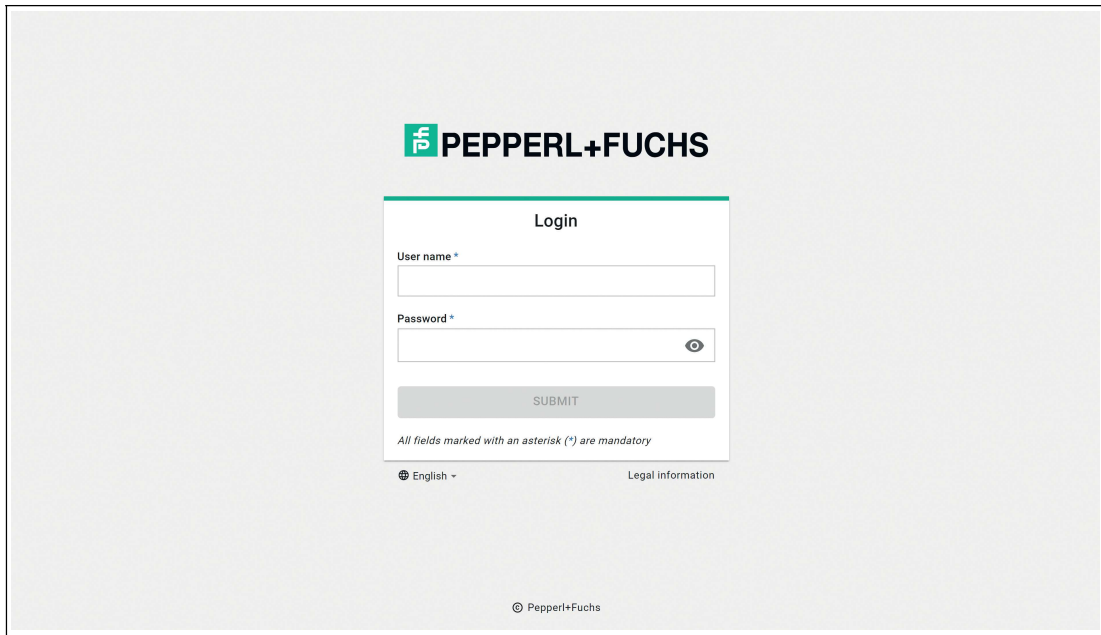

Figure 6.4

↳ The web interface dashboard opens.



Legal Information

Please refer to the legal information for the most important information on data protection and licenses.

1. Click on the "Legal information" field

↳ The "Legal information" window opens.

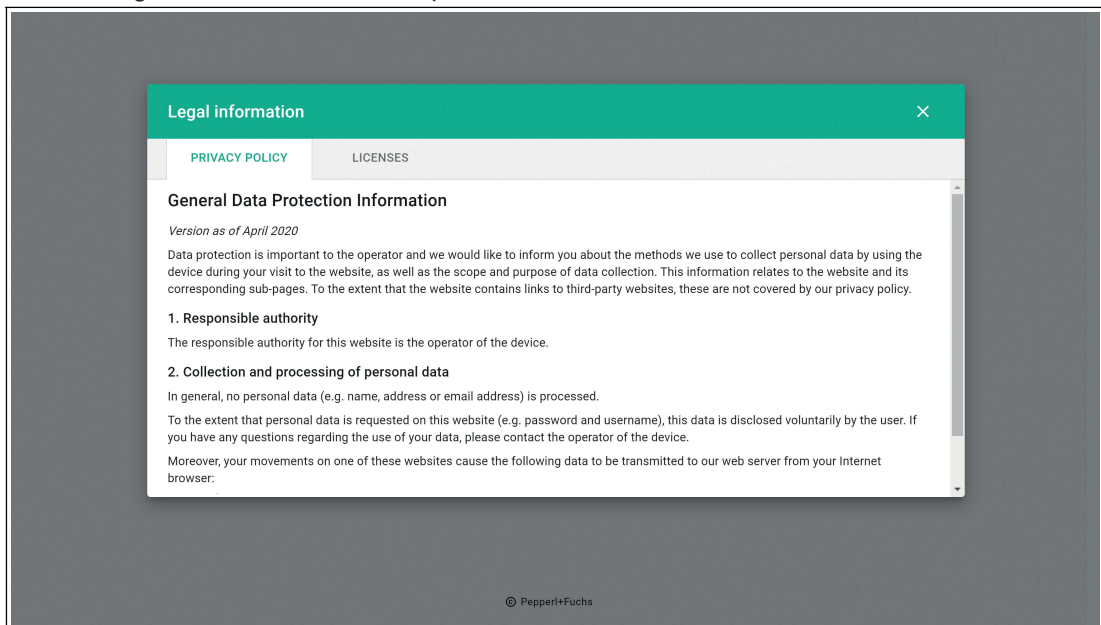

Figure 6.5

6.2.2 Dashboard

The web interface is responsive and optimized for viewing on desktop PCs, tablets, and smart-phones.

Ansicht Tablet

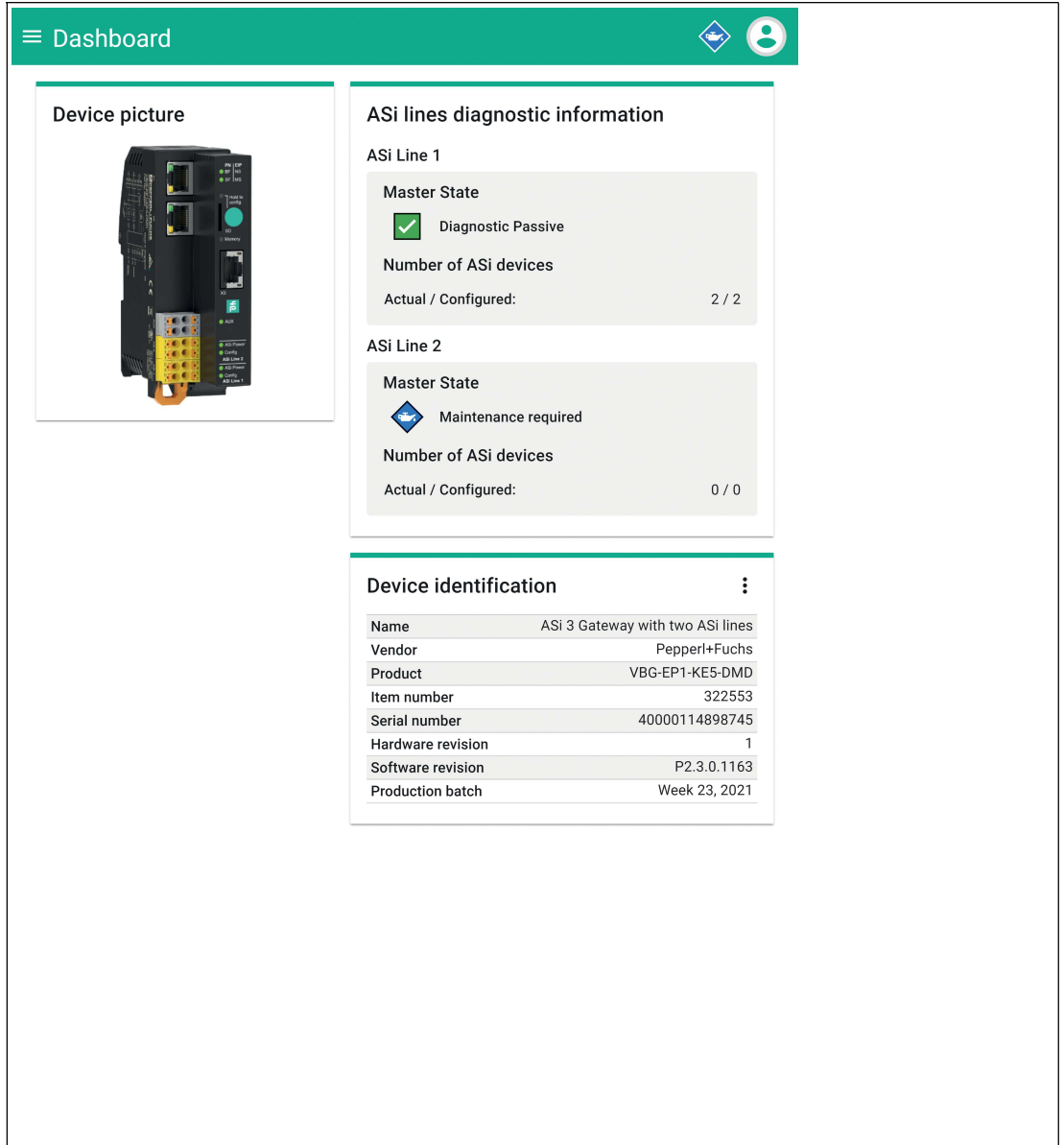



Figure 6.6

View smartphone

☰ Dashboard
🔒
👤

Device picture



ASi lines diagnostic information

ASi Line 1

Master State

✔ Diagnostic Passive

Number of ASi devices

Actual / Configured: 2 / 2

ASi Line 2

Master State

⬠ Maintenance required

Number of ASi devices

Actual / Configured: 0 / 0

Device identification ⋮

Name	ASi 3 Gateway with two ASi lines
Vendor	Pepperl+Fuchs
Product	VBG-EP1-KE5-DMD
Item number	322553
Serial number	40000114898745
Hardware revision	1
Software revision	P2.3.0.1163
Production batch	Week 23, 2021

Figure 6.7

View desktop PC

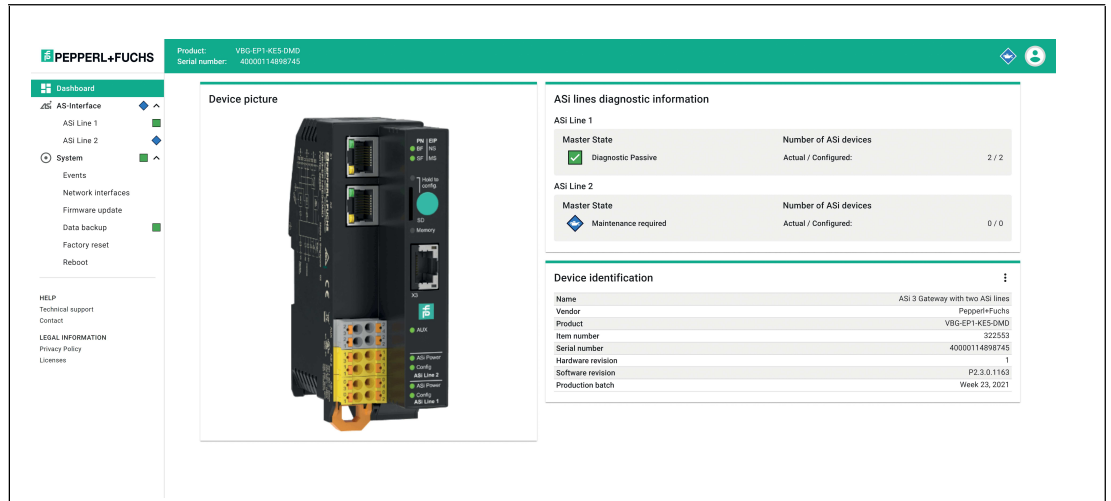

Figure 6.8



Note

The following descriptions refer to the display on a desktop PC.

Important Elements

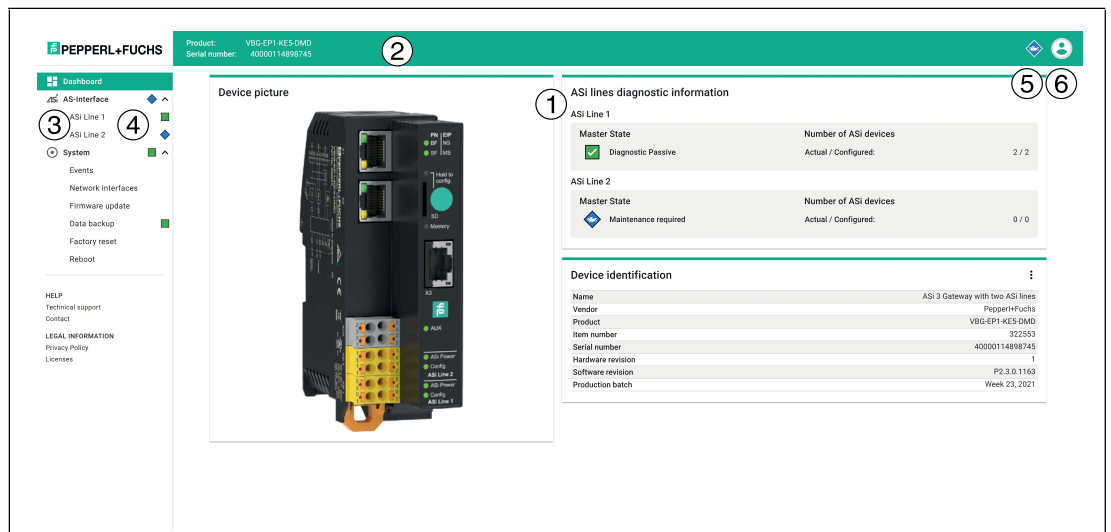

- 1 Main window
- 2 Upper bar
- 3 Navigation
- 4, 5 Diagnostic symbols
- 6 User menu

Main Window

The main window shows an overview of the following topics:

- Device picture
- Diagnostics summary for AS-Interface segment 1 and AS-Interface segment 2
- Device identification

Top Bar

The top bar contains information that is always visible to the user:

- Device identification: Product name and serial number
- System-wide diagnostics symbol
- User menu:
 1. Web interface language setting
 2. User settings for the current session
 3. Password change

Diagnostic Symbols

The web interface informs the user at various levels about diagnostic states in the system. This diagnostic information is shown using the following symbols and dependencies. The meaning of the symbols depends on the information associated with them.







Symbol	Color	Description
	Gray	Diagnostics disabled
	Green	Device or system is enabled
	Blue	Servicing required
	Yellow	Out of Specification <ul style="list-style-type: none"> • System is outside of the permitted specification • System has a problem that is outside of the system scope, such as a peripheral fault
	Orange	Check function
	Red	Error

Table 6.1

Dependencies

Top Bar	Displays the system-wide diagnostics of the device. Summarizes the top-level diagnostic data in the navigation.
Navigation	Diagnostic symbols are shown separately and refer to the respective description of the element, e.g., "AS-Interface segment 1." You can use the navigation arrows to navigate through the list. The individual list elements are grouped together with a diagnostic symbol.
Main window	Detailed description and analysis of individual faults.

6.2.3 AS-Interface

The "AS-Interface" menu allows you to access the various AS-Interface segments with the associated gateway and the respective AS-Interface nodes.

You can configure and commission the system, use diagnostics, or retrieve diagnostic and statistical information.

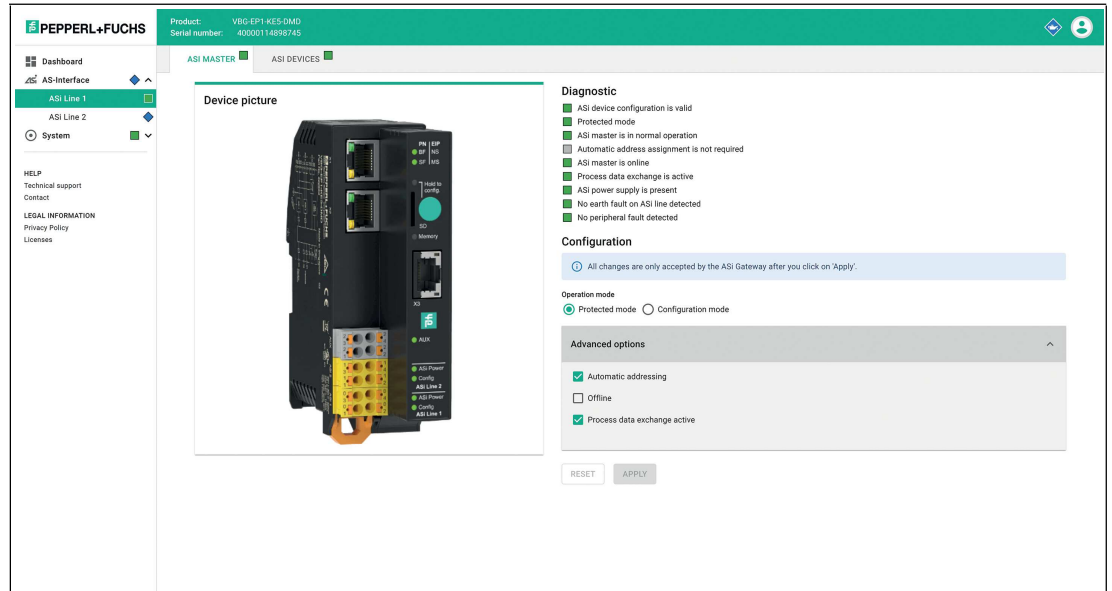

Figure 6.9



Note

AS-Interface segment 2 is only supported by the VBG-EP1-KE5-DMD.

"ASI MASTER" Tab

You will find status information about the AS-Interface segments under the "ASI MASTER" tab. You can configure the gateway and the respective segment.

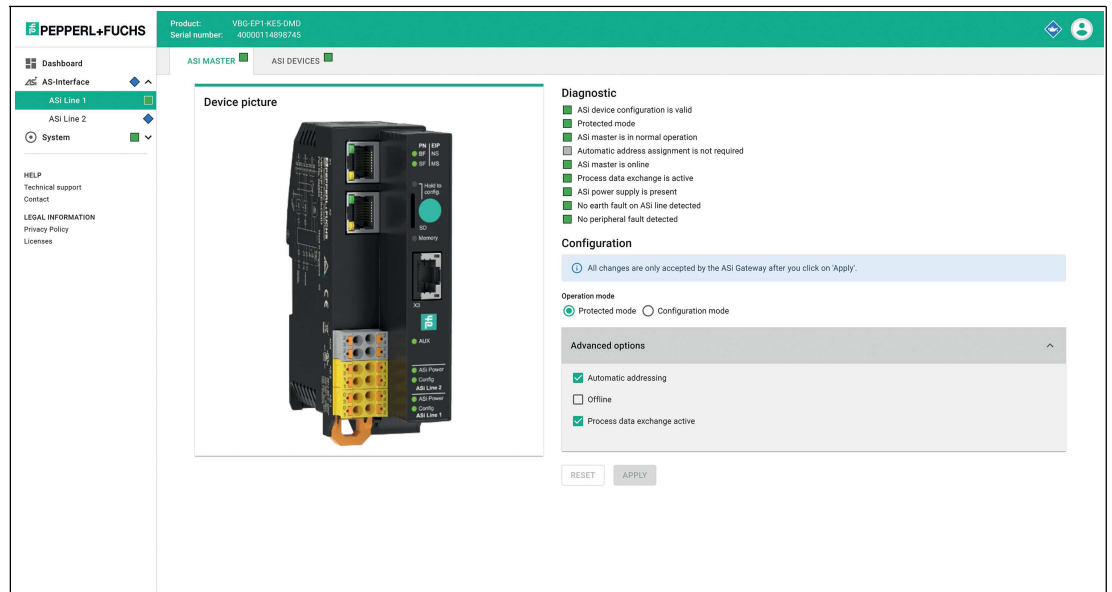

Figure 6.10

Diagnostics

In the "Diagnostics" area, you will find information about the gateway and/or the AS-Interface segment.

Configuration

You can configure the gateway and all nodes in the "Configuration" area.

Operating Mode

- In **Protected mode**, the gateway only enables projected nodes. Any unexpected or incompatible nodes are not enabled for process data exchange.
- In **Configuration mode**, the gateway accepts all nodes and allows interaction with them, e.g., via a PLC.

Automatic Address Assignment

- The **Automatic addressing** check box enables automatic address assignment in protected mode. This enables the gateway to automatically address new nodes that were installed in place of a faulty node. The new node must be compatible with the faulty node. If a node is replaced with an incompatible node, the address must be assigned manually. Automatic address assignment attempts to change the AS-Interface address of a new node if it is the only compatible device for a missing device.

Offline

- The **Offline** check box switches the gateway for the respective AS-Interface segment to offline mode.

Data Exchange Active

- The gateway does not exchange process data with detected nodes.

AS-Interface Master Deactivated

- You can deactivate one of the AS-Interface segments for the double master if this segment is not used. The deactivated segment does not generate any error messages. Deactivate an AS-Interface segment in the web interface in the "ASI-MASTER" tab. The menu item "AS-Interface master deactivated" can be found in "Advanced options".
 - Check the checkbox and click "Apply". The AS-Interface segment will be deactivated.



Note

Activate the deactivated AS-Interface segment by unchecking the checkbox. Then click "Apply".



Figure 6.11

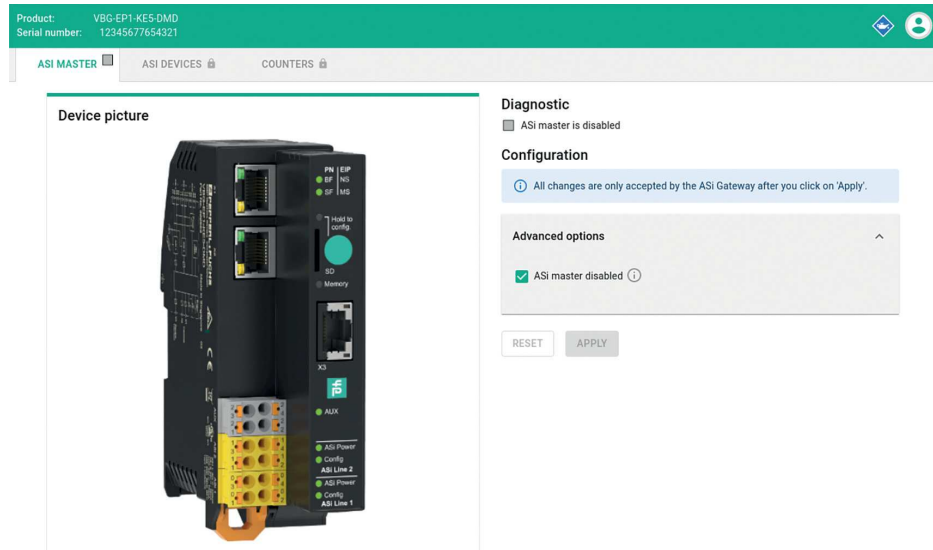

Figure 6.12

"ASI DEVICES" Tab

Under the "ASI DEVICES" tab, you will find all the nodes of the respective AS-Interface segment that the gateway expects or finds.

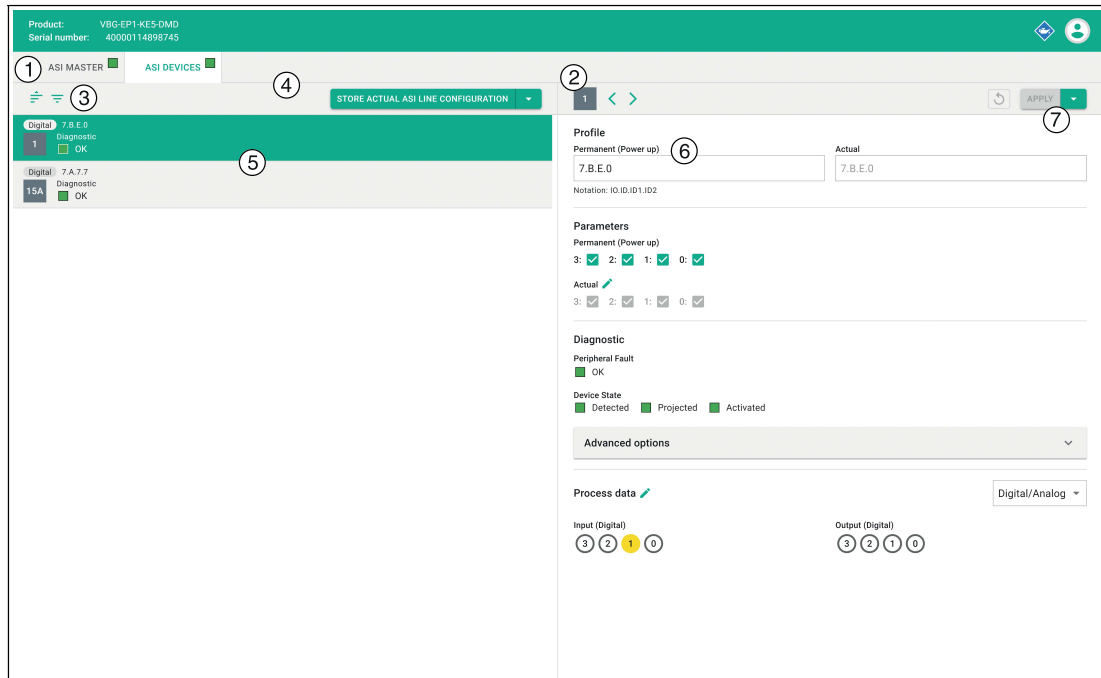

Figure 6.13

- 1 Overview of AS-Interface nodes
- 2 Information about the selected node
- 3 Filter for node list
- 4 AS-Interface segment action menu
- 5 Information about individual nodes
- 6 Status and configuration of the selected node
- 7 Action menu of the selected node

Overview of AS-Interface Nodes

List of all nodes in the selected segment. The overview includes the following functions:

Filter ASi device list

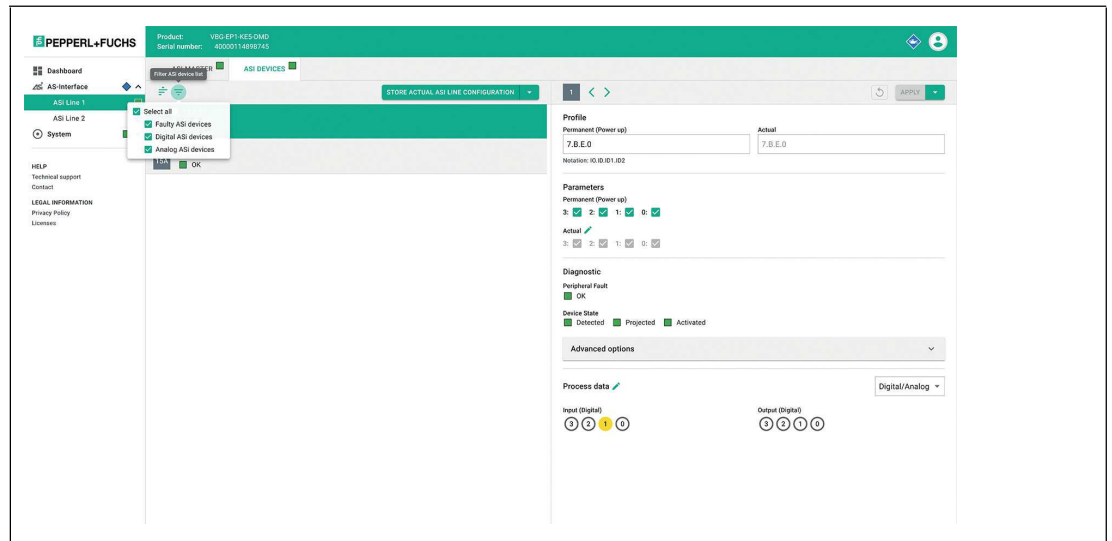

Figure 6.14

You can filter the list of nodes based on the following criteria:

- Faulty nodes
- Digital nodes
- Analog nodes

AS-Interface Segment Action Menu

- You can save all existing nodes from the list of ASI DEVICES on the AS-Interface segment in the list of expected LPS nodes. Nodes are available if they are included in the list of detected LDS nodes.
- You can manually add more nodes to the expected nodes.



Note

All nodes that you add via the web interface must be connected to the AS-Interface segment. Unconnected nodes are deleted when they are transferred to the LPS.

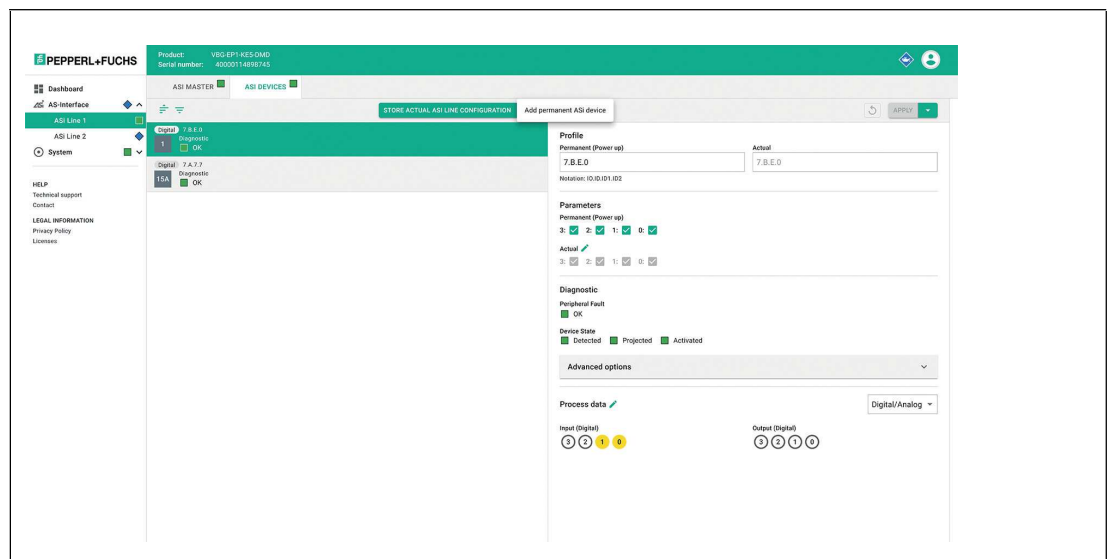

Figure 6.15

Information about individual devices



Figure 6.16

- The list entry shows:
 - The profile
 - The type of node: digital or analog
 - The address
 - Diagnostic information of the respective node

Information about the Selected AS-Interface Node

Detailed display of all information about the selected node. The overview includes the following functions:

Status and Configuration

- Informs about the node settings expected by the gateway
 - Shows the currently detected device information
 - Allows commissioning without PLC

Profile

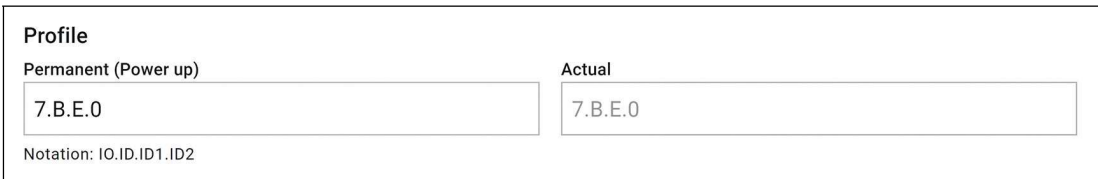

Figure 6.17

- The "Permanent (Power up)" field displays the projected AS-Interface node profile that the gateway expects.
- The "Actual" field displays the detected AS-Interface node profile of the connected node.

Parameters



Figure 6.18

- The "Permanent (Power up)" field displays the projected AS-Interface parameters that the gateway expects.
- The "Actual" field displays the AS-Interface parameters of the connected node currently in use.
- You can click on the pen icon to modify the parameters of the node in "Force" mode.



Warning!

Parameter changes

If you change the parameters of a node via the web interface, you are responsible for any safety-relevant effects.

Make sure that the system is taken out of operation before you change the parameters.

You are responsible for ensuring that the parameters match the expected states in the application after exiting "Force" mode. After exiting "Force" mode, the modified parameters are applied immediately.

Diagnostic

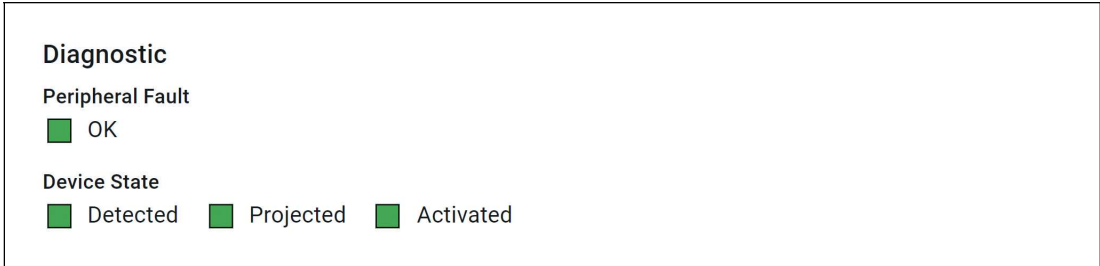

Figure 6.19

Diagnosis Information

- OK
- Peripheral faults
- Missing node

Device Status

- Detected
- Projected
- Enabled

Advanced options



Figure 6.20

Using the advanced options, it is possible to do the following:

1. Read the identification or diagnosis of a node that uses CTT1 strings.
2. Configure the deceleration and acceleration ramps of a G20 motor control module.

CTT1 identification

AS-Interface nodes with profile S-7.4 feature an identification string (ID string) with device-specific identification information. The length of the character string is defined by the AS-Interface node. The ID string is usually limited to 33 bytes, but can be up to 220 bytes in length according to the AS-Interface-3 specification. Depending on the manufacturer, shorter ID strings can also be used. The AS-Interface gateway reads the complete ID string from the AS-Interface node. The read data contains AS-Interface-specific information about the AS-Interface node. The data provides information about the behavior of the device in the AS-Interface network. The data structure of the ID string is described in the AS-Interface specification.

ID string, Interpretation Aid

Word		Bit 7	Bit 6	Bit 5	Bit 4	Bit 3	Bit 2	Bit 1	Bit 0
0	low	MUX			E-type				
	high	I/O	2D	DT_START			DT_COUNT		
P		EDT_READ			X	X	DIAG	F=1	V=1
1	low	Number of READ parameter bytes							
	high	Number of WRITE parameter bytes							
P		EDT_READ			X	X	X	F=1	V=1
2	low	Manufacturer code							
	high	Device Identifier 1							
P								F=1	V=1
3	low	Device Identifier 2							
	high	Device Identifier 3							
P								F=1	V=1
4	low	Device Identifier 4							
	high	Device Identifier 5							
P								F=1	V=1
5	low	Device Identifier 6							
	high	Device Identifier 7							
P								F=1	V=1

Table 6.2

Between bytes 0 to 5 there is 1 protocol byte P. Refer to the manual of your AS-Interface node for the meaning of the fields.

CTT1 Diagnostics

AS-Interface nodes with the S-7.4 profile feature the following functions:

AS-Interface nodes with profile S-7.4 feature a diagnostic string (Read Diagnostic string) with device-specific diagnostic information. Processes are logged permanently during operation. These protocols are stored in an internal memory in a volatile state until the operating voltage is switched off. The length of the character string is defined by the AS-Interface node. The diagnostic string is usually limited to 33 bytes, but can be up to 220 bytes in length according to the AS-Interface-3 specification. Depending on the manufacturer, shorter diagnostic strings can also be used.

Structure of a Diagnostic Character String

Word		Bit 7	Bit 6	Bit 5	Bit 4	Bit 3	Bit 2	Bit 1	Bit 0
0	low	Diagnostic Byte 1							
	high	Diagnostic Byte 2							
1	low	Diagnostic Byte 3							
	high	Diagnostic Byte 4							
3	low	Diagnostic Byte 5							
	high	Diagnostic Byte 6							
...									
109	low	Diagnostic Byte 219							
	high	Diagnostic Byte 220							

Table 6.3

2023-06

Refer to the documentation of the AS-Interface node for details on the content of the diagnostic string.

Configuring motor control (G20)

The "Configure motor control (G20)" function is designed generically for future expansions.

The G20 motor module uses the "Ramp" parameter.

For example: To activate ramp 2, enter the value "02" in the input field.

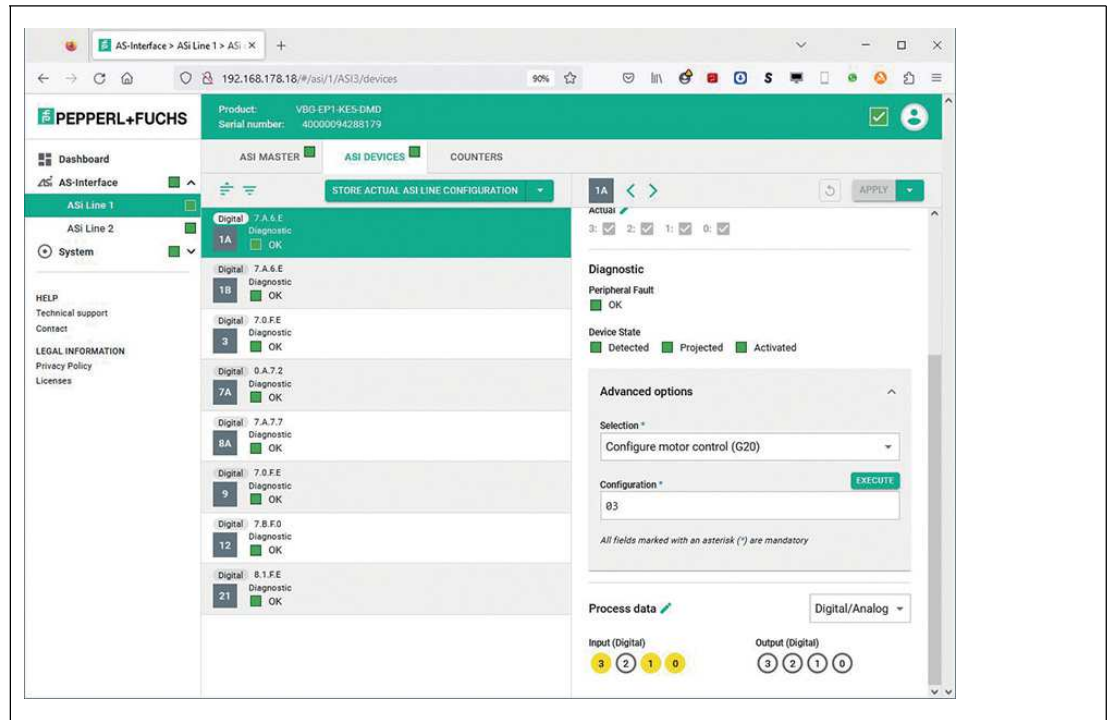

Figure 6.21

Process data

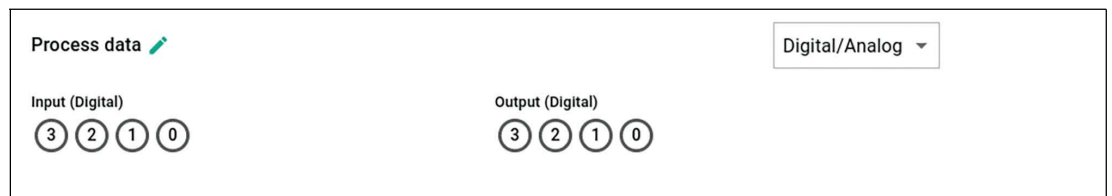

Figure 6.22

- Displays the input and output process data of the node. The representation of the process data depends on the respective node.
- You can click on the pen icon to modify the outputs of the node in "Force" mode.



Caution!

Changing process data

As a user, you are responsible for any changes to the process data of a node made via the web interface.

As a user, you are responsible for making sure that the system is taken out of service before you make any changes to the process data.

A change in the process data of the device can result in the following consequences or events (this list is not exhaustive):

- Switching of outputs
- Physical damage to actuators, e.g., motors
- Damage to the system
- Personal injury

CTT2

In the "Digital/Analog" selection field, you can modify process data by selecting "CTT2 direct access."

AS-Interface nodes with profile S-7.5.5 or S-7.A.5 feature various setting options via CTT2. Several pieces of status information are available. The settings and status information are organized in indices.

Refer to the documentation of the AS-Interface node for further details.

Process data CTT2

Process data

CTT2 direct access ▼

Request (Execute) *

EXECUTE

12:07:2a

Response (Execute)

```
52:01:00:00:60:66:66:66:66:66:FF:FF:0F:00:00:
00:00:00:00:00:00:00:00:00:00:00:00:00:00:
00:00:00:00:00:00:00:00:00:00:00:00:00
```

All fields marked with an asterisk () are mandatory*

Figure 6.23

Enter the CTT2 request, the index of the target object, and the data length in the "Request" field. Enter the information as HEX values.

The AS-Interface specification defines request types 16_{DEC} to 27_{DEC} and 29_{DEC} to 32_{DEC}. The following table shows the most common request types:

CTT2 Request Types

0x10	16 _{DEC}	acyclic standard read service request
0x11	17 _{DEC}	acyclic standard write service request
0x12	18 _{DEC}	acyclic vendor specific read service request
0x13	19 _{DEC}	acyclic vendor specific write service request

For the correct request number of the individual AS-Interface nodes and the information read via CTT2, consult the manufacturer's information on the nodes.

Action Menu of the Selected Node

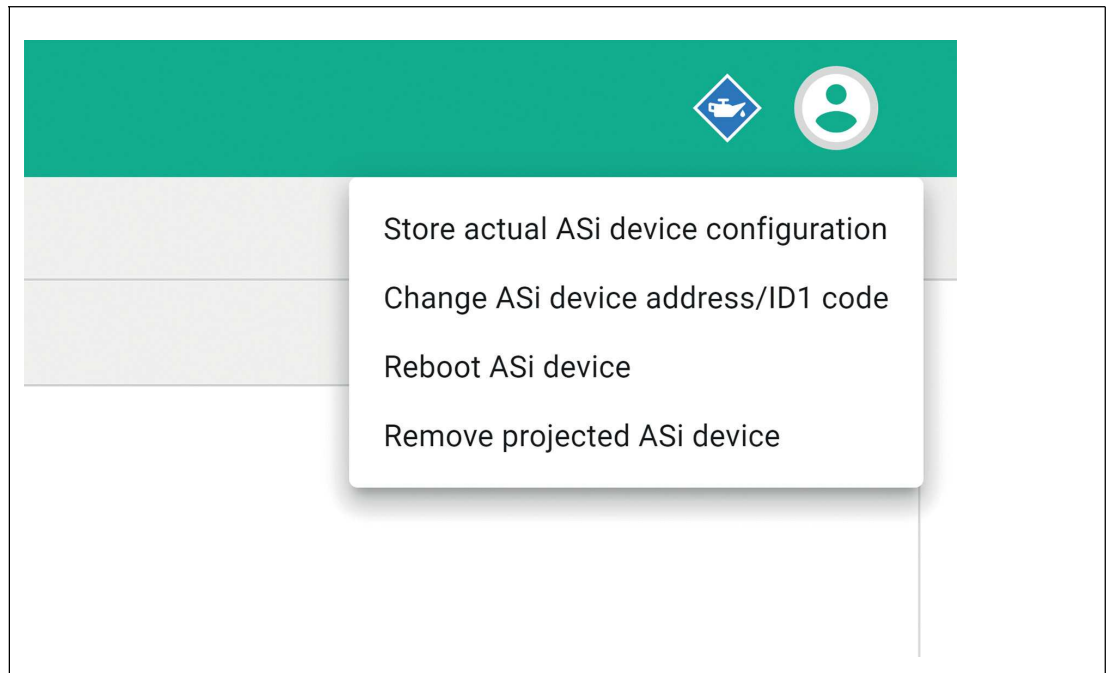

Figure 6.24

The action menu allows you to control the following functions:

- Change an AS-Interface device identification: Change AS-Interface address/ID1 code:
- Accept the projected profiles and parameters from the form
- Use a detected profile and parameters as projected: Change device configuration
- Reset a node: Force reboot and reconnection
- Remove nodes from the list of projected nodes for the gateway

Change ASi device address/ID1 code

Change ASi device address/ID1 code
✕

i This dialog changes the address/ID1 code settings in the ASi device itself.
The ASi gateway will not update the stored configuration expectation.

Address * i

The ASi device address is a unique identifier on the ASi line

ID1 code * i

The extended ID1 code allows to set the customer specific identifier

All fields marked with an asterisk (*) are mandatory

Figure 6.25

"Counter" Tab

The "Counter" tab contains various pieces of diagnostic and statistical information.

Figure 6.26

For all activated nodes, error telegrams and the total number of telegrams since the last switch-on or a counter reset are counted continuously.

Meaning of the columns:

Missing	Number of gateway calls to which an AS-Interface node has not responded.
Corrupt	Number of AS-Interface node responses that were corrupt. Corrupt responses are discarded
Continuous	Number of consecutive telegrams that were not received correctly by a node. If a node telegram has not been received correctly by the gateway, the gateway sends a repeat telegram. The gateway then communicates with the next node. The missing or corrupt node is opened again by the gateway in the next cycle. After three AS-Interface cycles or six consecutive missing or corrupt telegrams, the node is removed from the list of active nodes. The gateway reports a configuration error for this AS-Interface node.
Node error	Number of configuration errors that an AS-Interface node has created.
Protocol error	This error indicates how often errors occurred in the data transfer protocol for AS-Interface nodes that transfer related data in several cycles (Combined Transaction Types).

You can reset the counters manually.

- You can reset all counters together using the "three dots" action menu in the table header.
- You can reset individual counters using the "three dots" action menu on the left of the relevant line.

6.2.4 System

The "System" menu contains the following content:

- List of **events**
- Setting the **fieldbus protocol**
- Configuration of the **network interface**
- **Firmware update**
- **Data backup**
- **Factory reset**
- **Restart** of the device.

6.2.4.1 Events

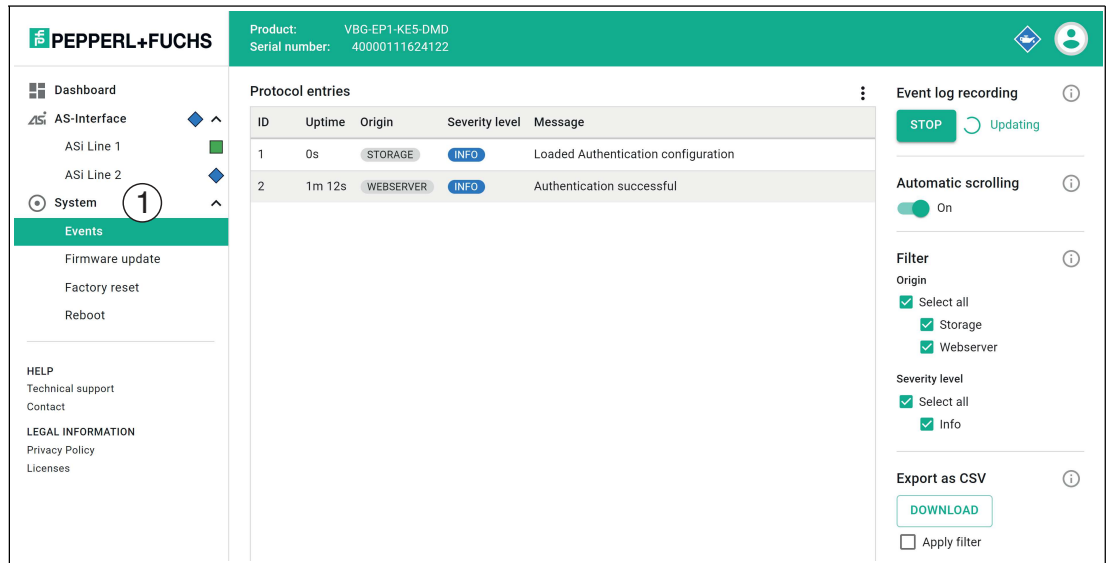

Figure 6.27

Under the "Events" menu item (1), you will find a list of all gateway events with a log of the severity of the event and an explanation. This function contains a filter that enables users to search through the events in a structured way.

6.2.4.2 Fieldbus Protocol

The factory setting for the fieldbus protocol is PROFINET. You can change the fieldbus protocol of the gateway in the "Fieldbus" menu item using the web interface.



Configuring the Fieldbus Protocol



Caution!

IP Address

Changing the fieldbus protocol resets the network parameters. You must reassign the network parameters after changing the fieldbus protocol.

1. Select the desired fieldbus protocol from the drop-down menu.

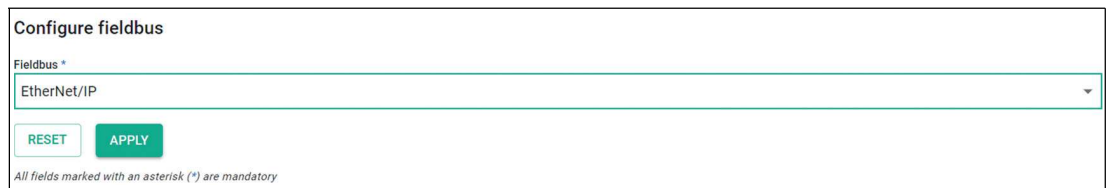

Figure 6.28

2. Click "Apply" to confirm this selection.
3. Confirm the security prompt.

↳ The gateway restarts and changes the fieldbus protocol.



Note

You can switch between EtherNet/IP and PROFINET using the push button on the device, see chapter 6.1.

If the fieldbus protocol is set to PROFINET, you can assign a station name.

Figure 6.29



Note

The PROFINET specification only allows lower case letters.

6.2.4.3

Network Interfaces

Figure 6.30

Under the "Network interfaces" menu item, you can change the configuration of the industrial Ethernet interface X1/X2 via the web interface.

The required IP address for operation using EtherNet/IP or PROFINET can be stored in the device.

Click "Apply" to save the changes. The device will then restart.

You cannot make any settings in the X1 and X2 tabs. The MAC address of the ports is displayed here.

6.2.4.4 Firmware Update

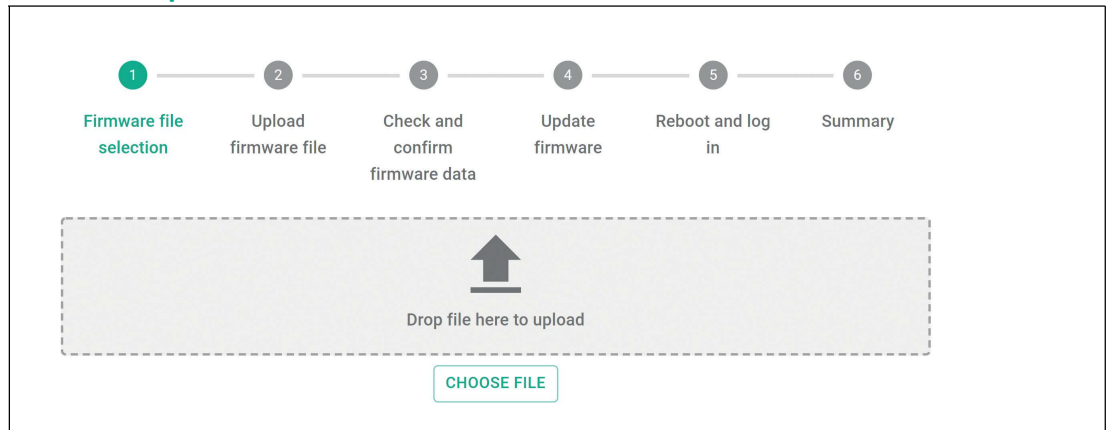

Figure 6.31

You have the option to upload a new firmware file via the web interface under the "Firmware update" menu item.

If a firmware update is required, the wizard will guide you through the process of updating the gateway.



Note

The firmware update is only possible via Ethernet interfaces X1/X2

6.2.4.5 Data Backup

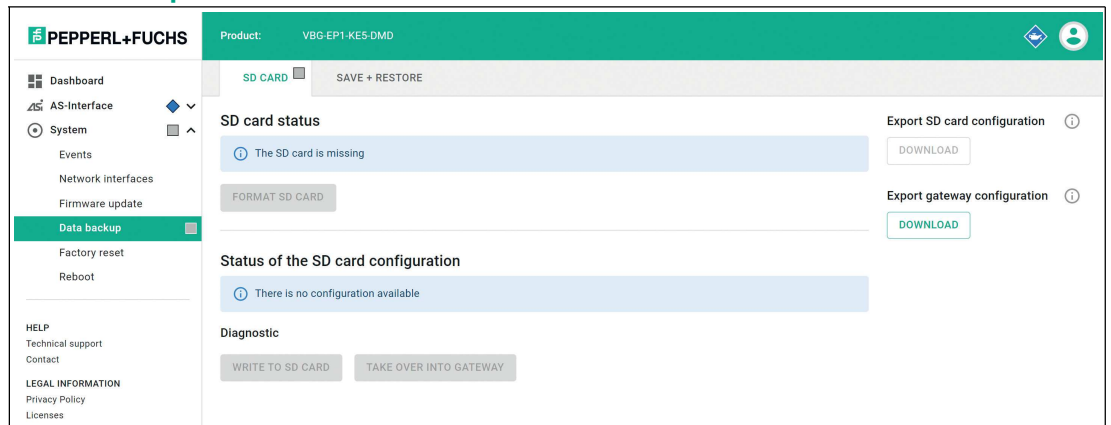

Figure 6.32

Under the "Data backup" menu item, you can back up and restore the configuration of the gateway. The gateway uses an SD card for data backup. See chapter 4.1.5.

"SD CARD" Tab

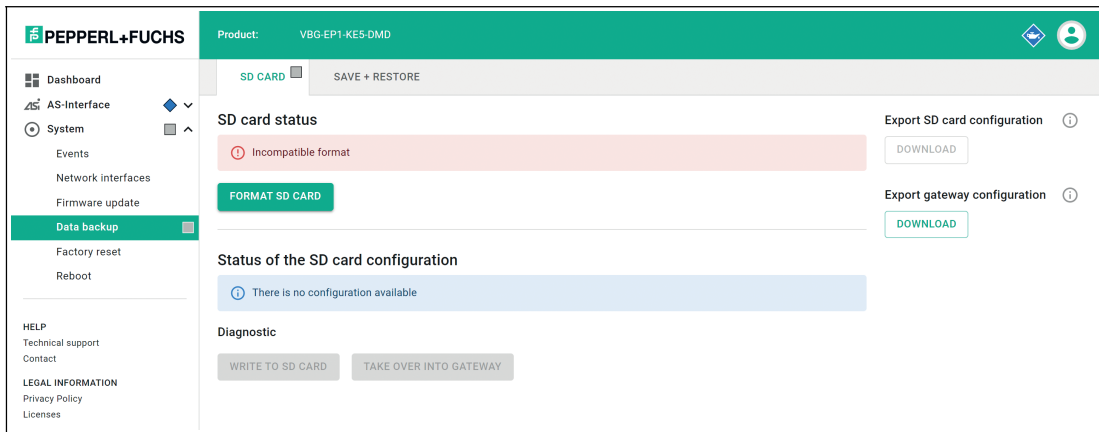

Figure 6.33

Status of the SD Card

This section of the tab displays the status of the SD card.

You can format SD cards that have an incompatible file format.



Warning!

Data Loss

Formatting a read/write tag will result in any data saved on it being lost.

If the device has formatted the SD card or a correctly formatted SD card is inserted, the current configuration data of the device is automatically saved to the SD card.

Status of the SD Card Configuration

This section of the tab displays the status of the SD card configuration.

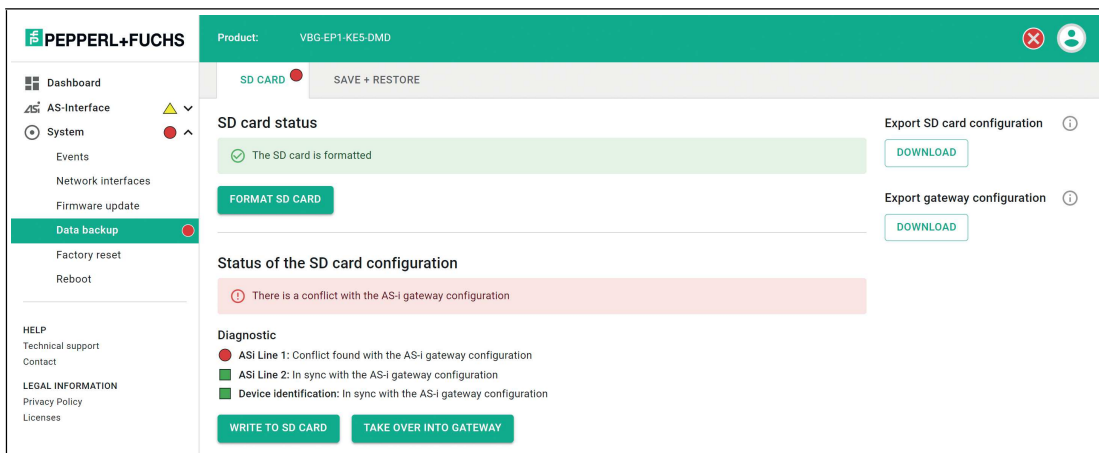

Figure 6.34

If the device detects an SD card with valid configuration data that differs from the projected configuration, the web interface reports a conflict.

Resolving a conflict:

1. Click "Write to SD card."
The configuration data on the SD card is overwritten with the projected configuration data on the gateway. A warning message appears, which you must acknowledge.
2. Click "Copy from SD card."
The projected configuration data of the gateway is overwritten with the configuration data on the SD card. A warning message appears, which you must acknowledge.
The gateway restarts.

"SAVE + RESTORE" Tab

Use this tab to export and import the gateway configuration.

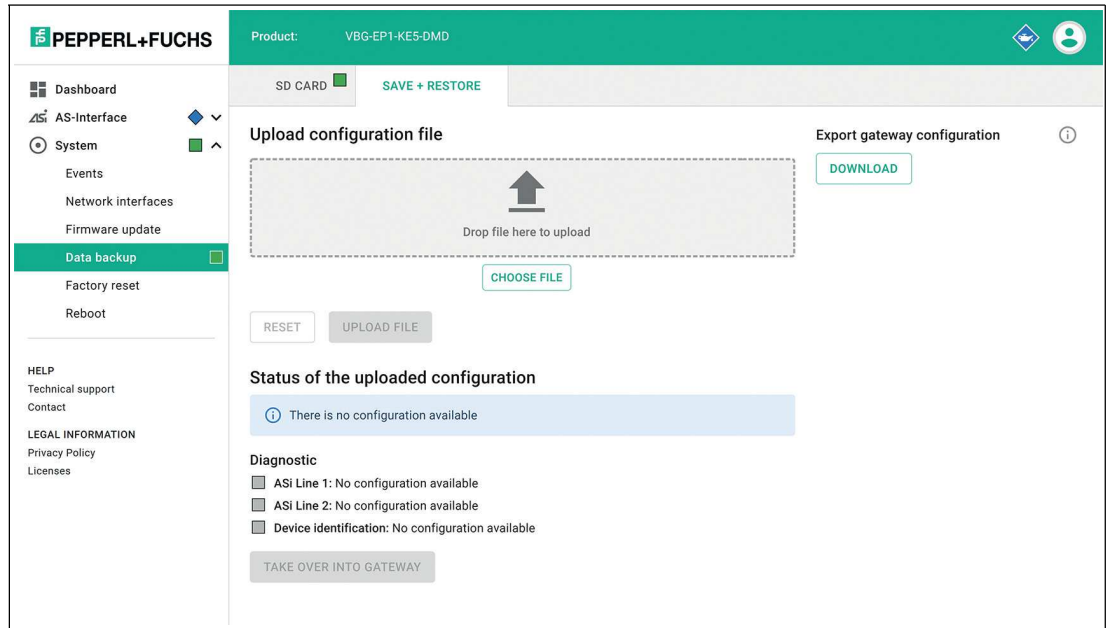

Figure 6.35

6.2.4.6

Factory Settings

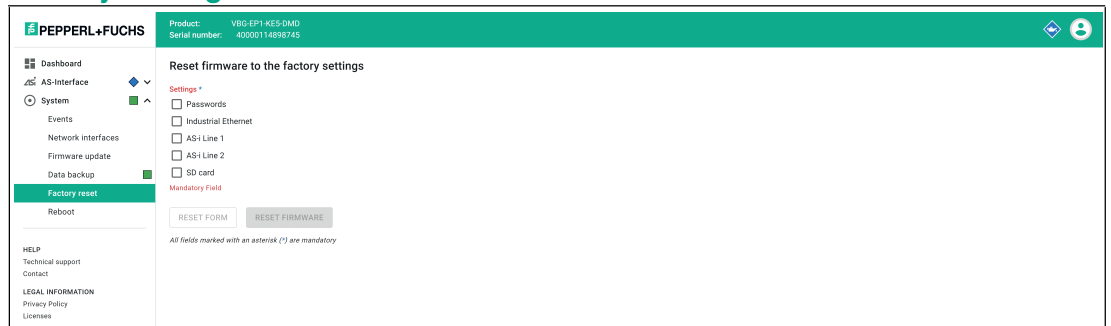

Figure 6.36

You can reset the following entries or settings to the factory settings under the "Factory settings" menu item:

- Passwords
- Industrial Ethernet
- AS-Interface segment 1
- AS-Interface segment 2
- SD card



Tip

For a factory reset with or without I&M data in the TIA Portal, see chapter 5.2.1.3.

6.2.4.7

Restarting

Figure 6.37

You can restart the gateway without disconnecting it from the power supply under the "Restart" menu item.

6.3

Configuration Interface X3

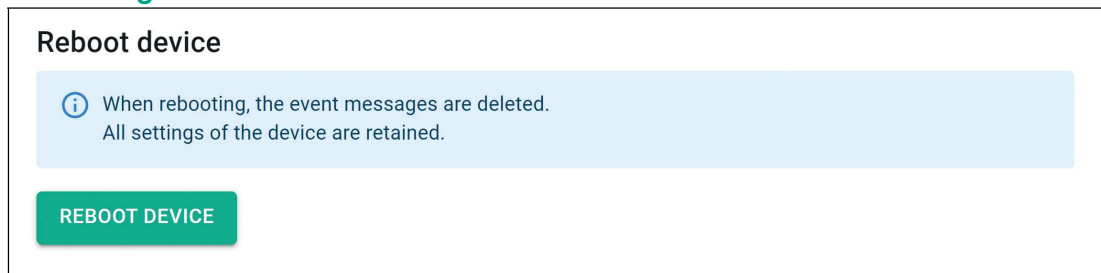
The gateway has Ethernet-based configuration interface X3. Interface X3 is independent of Ethernet interfaces X1 and X2. The configuration interface is used to diagnose and configure the gateway. The configuration interface does not support a firmware update. Use Ethernet interface X1/X2 for a firmware update; see chapter 4.1.4.

The configuration interface is designed as a point-to-point connection. Communication takes place via a web interface.

The web interface is accessed with a web browser by entering the IP address `http://192.168.1.2`. You cannot change this IP address.

For details on the web interface, see chapter 6.2.

Note

The PC and gateway must be on the same subnet for access. Assign an IP address between `192.168.1.3` and `192.168.1.255` to your PC and set the subnet mask to `255.255.255.0`.

6.4

REST API

The ASi gateway has a REST API for configuration. REST = Representational State Transfer, API = Application Programming Interface

An interface description is available on request.

7 Servicing and Overhaul

The device is designed and constructed to work robustly for long periods of time. For this reason, regular cleaning or servicing is not required.

In the event of a failure, always replace the device with an original device.

8 Annex A: PROFINET Command Interface Commands and Data Layout

8.1 Get Permanent Parameter

The `Get Permanent Parameter` command reads out the parameter value that is expected for each node in the gateway.

The length of the payload data of the `Get Permanent Parameter` command and the response is 1 byte. The payload data is in the format shown in the tables below.

Format of the Command Request

Byte	Bit 7	Bit 6	Bit 5	Bit 4	Bit 3	Bit 2	Bit 1	Bit 0
0	0x01							
1	T	-	-	-	-	-	-	Segment
2	-		A/B	ASi node address				

Table 8.1

Format of the Command Response

Byte	Bit 7	Bit 6	Bit 5	Bit 4	Bit 3	Bit 2	Bit 1	Bit 0
0	0x01							
1	T	Error code						
2	-				PP3 ¹	PP2	PP1	PP0

Table 8.2

1. PP = Permanent parameter

8.2 Write Parameter

The `Write Parameter` command overwrites the current parameter value of the addressed node. The parameter value is stored in volatile memory in the gateway.

The command only addresses active nodes.

The response contains the parameter value returned by the node, which may differ from the written value.

The length of the payload data of the `Write Parameter` command is 2 bytes and the length of the payload data of the response is 1 byte. The payload data is in the format shown in the tables below.

Format of the Command Request

Byte	Bit 7	Bit 6	Bit 5	Bit 4	Bit 3	Bit 2	Bit 1	Bit 0
0	0x02							
1	T	-	-	-	-	-	-	Segment
2	-		A/B	ASi node address				
3	-				P3 ¹	P2	P1	P0

Table 8.3

1. P = Parameter

Format of the Command Response

Byte	Bit 7	Bit 6	Bit 5	Bit 4	Bit 3	Bit 2	Bit 1	Bit 0
0	0x02							
1	T	Error code						
2	-				Node response			

Table 8.4

8.3 Read Parameter

The `Read Parameter` command returns the current parameter value¹ of the addressed node.

The length of the payload data of the `Read Parameter` command and the response is 1 byte. The payload data is in the format shown in the tables below.

Format of the Command Request

Byte	Bit 7	Bit 6	Bit 5	Bit 4	Bit 3	Bit 2	Bit 1	Bit 0
0	0x03							
1	T	-	-	-	-	-	-	Segment
2	-		A/B	ASi node address				

Table 8.5

Format of the Command Response

Byte	Bit 7	Bit 6	Bit 5	Bit 4	Bit 3	Bit 2	Bit 1	Bit 0
0	0x03							
1	T	Error code						
2	-				PA3 ¹	PA2	PA1	PA0

Table 8.6

1. PA = Parameter image

8.4 Store Actual Parameters

The `Store Actual Parameters` command overwrites the stored projected parameter values with the current actual parameter values. This stores the current parameters of all nodes as projected parameters. The projected parameters are sent to the ASi nodes each time the gateway is started.

No command request payload data and response payload data is required.

Format of the Command Request

Byte	Bit 7	Bit 6	Bit 5	Bit 4	Bit 3	Bit 2	Bit 1	Bit 0
0	0x04							
1	T	-	-	-	-	-	-	Segment

Table 8.7

1. Last parameter sent to the node or permanent parameter

Format of the Command Response

Byte	Bit 7	Bit 6	Bit 5	Bit 4	Bit 3	Bit 2	Bit 1	Bit 0
0	0x04							
1	T	Error code						

Table 8.8

8.5 Store Actual Configuration

The `Store Actual Configuration` command saves the current configuration data of the nodes as projected configuration data. The command is only executed in configuration mode.

Configuration data:

- IO code
- ID code
- ID1 code
- ID2 code
- ...

No command request payload data and response payload data is required.

Format of the Command Request

Byte	Bit 7	Bit 6	Bit 5	Bit 4	Bit 3	Bit 2	Bit 1	Bit 0
0	0x07							
1	T	-	-	-	-	-	-	Segment

Table 8.9

Format of the Command Response

Byte	Bit 7	Bit 6	Bit 5	Bit 4	Bit 3	Bit 2	Bit 1	Bit 0
0	0x07							
1	T	Error code						

Table 8.10

8.6 Set Offline Mode

The `Set Offline Mode` command switches between online and offline mode.

Online mode is the normal operating mode of the gateway. In offline mode, the gateway only processes jobs from the user. There is **no communication** with the nodes.

The `OFFLINE = TRUE` bit is not permanently stored, i.e., after a startup/restart, the gateway is set to online mode again.

The length of the payload data of the `Set Offline Mode` command is 1 byte. The payload data is in the format shown in the tables below.

Format of the Command Request

Byte	Bit 7	Bit 6	Bit 5	Bit 4	Bit 3	Bit 2	Bit 1	Bit 0
0	0x0A							
1	T	-	-	-	-	-	-	Segment
2	-	-	-	-	-	-	-	Offline mode flag

Table 8.11

Offline Phase Flag

- 0 Gateway is online
- 1 Gateway is offline

Format of the Command Response

Byte	Bit 7	Bit 6	Bit 5	Bit 4	Bit 3	Bit 2	Bit 1	Bit 0
0	0x0A							
1	T	Error code						

Table 8.12

8.7 Set Auto Address Enable

The `Set Auto Address Enable` command enables and disables the "Automatic addressing" function.

If automatic addressing is enabled, the gateway addresses nodes with the address 0. To do this, the gateway must detect missing configured nodes and identify them uniquely using the configuration data.

The `AUTO_ADDR_ENABLE` flag is stored in non-volatile memory, i.e., it is retained after a gateway startup/restart.

The length of the payload data of the `Set Auto Address Enable` command is 1 byte. The payload data is in the format shown in the tables below.

Format of the Command Request

Byte	Bit 7	Bit 6	Bit 5	Bit 4	Bit 3	Bit 2	Bit 1	Bit 0
0	0x0B							
1	T	-	-	-	-	-	-	Segment
2	-	-	-	-	-	-	-	Auto Address Enable flag

Table 8.13

Auto Address Enable Flag

- 0 Automatic addressing is disabled
- 1 Automatic addressing is enabled

Format of the Command Response

Byte	Bit 7	Bit 6	Bit 5	Bit 4	Bit 3	Bit 2	Bit 1	Bit 0
0	0x0B							
1	T	Error code						

Table 8.14

8.8 Set Operation Mode

The `Set Operating Mode` command switches the gateway to configuration mode or protected mode.

The gateway is operated in configuration mode during commissioning. Protected mode is the standard operating mode.

- In protected mode, the only nodes that are enabled are those:
 - That are listed in the LPS
 - Whose target and actual configuration match
- In configuration mode, all detected nodes are enabled except the node with the address 0. The target and actual configuration are checked, and if necessary, a configuration error is set.

The operation mode bit is stored in non-volatile memory, which means that it is retained even when the device is started up/restarted.

The length of the payload data of the `Set Operating Mode` command is 1 byte. The payload data is in the format shown in the tables below.



Caution!

Active outputs switched off

During the transition to the offline phase and the subsequent switchover to online mode, active outputs are briefly switched off.

Format of the Command Request

Byte	Bit 7	Bit 6	Bit 5	Bit 4	Bit 3	Bit 2	Bit 1	Bit 0
0	0x0C							
1	T	-	-	-	-	-	-	Segment
2	-	-	-	-	-	-	-	Operating mode

Table 8.15

Operating mode

- 0 Operating mode: Protected mode
- 1 Operating mode: Configuration mode

Format of the Command Response

Byte	Bit 7	Bit 6	Bit 5	Bit 4	Bit 3	Bit 2	Bit 1	Bit 0
0	0x0C							
1	T	Error code						

Table 8.16

8.9 Change Slave Address

The `Change Slave Address` command changes the address of a node.



Note

This command is not executed if another node occupies the address "0." see "The `Set Auto Address Enable` command enables and disables the "Automatic addressing" function." on page 139.

The length of the payload data of the `Change Slave Address` command is 2 bytes. The payload data is in the format shown in the tables below.

Format of the Command Request

Byte	Bit 7	Bit 6	Bit 5	Bit 4	Bit 3	Bit 2	Bit 1	Bit 0
0	0x0D							
1	T	-	-	-	-	-	-	Segment
2	-		A/B	Previous node address				
3	-		A/B	New node address				

Table 8.17

8.10 Set Permanent Configuration

The `Set Permanent Configuration` command sets the projected configuration data for the specified node. The configuration data is stored in the gateway in non-volatile memory.

This command is only allowed in configuration mode.

Using the saved configuration data and the LPS, the gateway can determine whether there are any configuration errors by comparing them with the configuration data of the existing nodes.



Caution!

Active outputs switched off

During the transition to the offline phase and the subsequent switchover to online mode, active outputs are briefly switched off.

The length of the payload data of the `Set Permanent Configuration` command is 3 bytes. The payload data is in the format shown in the tables below.

Format of the Command Request

Byte	Bit 7	Bit 6	Bit 5	Bit 4	Bit 3	Bit 2	Bit 1	Bit 0
0	0x25							
1	T	-	-	-	-	-	-	Segment
2	-		A/B	ASi node address				
3	ID2 code				ID1 code			
4	ID code				IO code			

Table 8.18

Format of the Command Response

Byte	Bit 7	Bit 6	Bit 5	Bit 4	Bit 3	Bit 2	Bit 1	Bit 0
0	0x25							
1	T	Error code						

Table 8.19

8.11 Get Permanent Configuration

The `Get Permanent Configuration` command reads the projected configuration data:

- IO code
- ID code
- ID1 code
- ID2 code

The length of the payload data of the `Get Permanent Configuration` command is 1 byte and the length of the payload data of the response is 2 bytes. The payload data is in the format shown in the tables below.

Format of the Command Request

Byte	Bit 7	Bit 6	Bit 5	Bit 4	Bit 3	Bit 2	Bit 1	Bit 0
0	0x26							
1	T	-	-	-	-	-	-	Segment
2	-		A/B	ASi node address				

Table 8.20

Format of the Command Response

Byte	Bit 7	Bit 6	Bit 5	Bit 4	Bit 3	Bit 2	Bit 1	Bit 0
0	0x26							
1	T	Error code						
2	ID2 code				ID1 code			
	ID code				IO code			

Table 8.21

8.12 Read Actual Configuration

The `Read Actual Configuration` command reads the current configuration data of the detected node from the gateway:

- EA configuration
- ID code
- ID1 code
- ID2 code

The length of the payload data of the `Read Actual Configuration` command is 1 byte, the length of the payload data of the response is 2 bytes. The payload data is in the format shown in the tables below.

If a node is not detected at the specified address, the command response contains four instances of the default value 0xF.

Format of the Command Request

Byte	Bit 7	Bit 6	Bit 5	Bit 4	Bit 3	Bit 2	Bit 1	Bit 0
0	0x28							
1	T	-	-	-	-	-	-	Segment
2	-		A/B	ASi node address				

Table 8.22

Format of the Command Response

Byte	Bit 7	Bit 6	Bit 5	Bit 4	Bit 3	Bit 2	Bit 1	Bit 0
0	0x28							
1	T	Error code						
2	ID2 code				ID1 code			
3	ID code				IO code			

Table 8.23

8.13 Set LPS

The `Set LPS` command saves the list of projected nodes on the gateway in non-volatile memory.

The length of the payload data of the `Set LPS` command is 9 bytes. The format of the payload data is shown in the tables below.

Format of the Command Request

Byte	Bit 7	Bit 6	Bit 5	Bit 4	Bit 3	Bit 2	Bit 1	Bit 0
0	0x29							
1	T	0	-	-	-	-	-	Segment
2	-							
3	7A/7	6A/6	5A/5	4A/4	3A/3	2A/2	1A/1	-
...
7	7B	6B	5B	4B	3B	2B	1B	-
...
10	31B	30B	29B	28B	27B	26B	25B	24B

Table 8.24

Bit

- 0** A node at the address corresponding to the bit is not expected.
- 1** A node at the address corresponding to the bit is expected.

Format of the Command Response

Byte	Bit 7	Bit 6	Bit 5	Bit 4	Bit 3	Bit 2	Bit 1	Bit 0
0	0x29							
1	T	Error code						

Table 8.25

8.14 Get LPF

The `Get LPF` command reads a list of nodes reporting a peripheral fault. The LPF is updated cyclically by the gateway. Errors of the nodes or the connected peripherals can be found in the corresponding product documentation of the node.

No command request payload data is required.

The length of the payload data of the `Get LPF` command response is 8 bytes. The format of the payload data is shown in the tables below.

Format of the Command Request

Byte	Bit 7	Bit 6	Bit 5	Bit 4	Bit 3	Bit 2	Bit 1	Bit 0
0	0x3E							
1	T	0	-	-	-	-	-	Segment

Table 8.26

Format of the Command Response

Byte	Bit 7	Bit 6	Bit 5	Bit 4	Bit 3	Bit 2	Bit 1	Bit 0
0	0x3E							
1	T	Error code						
2	7A/7	6A/6	5A/5	4A/4	3A/3	2A/2	1A/1	-
...
6	7B	6B	5B	4B	3B	2B	1B	-
...
9	31B	30B	29B	28B	27B	26B	25B	24B

Table 8.27

Bit

- 0** At the address specified by the bit, either an active node has no peripheral fault, a node is not enabled, or a node is not present.
- 1** A node at the address corresponding to the bit reports a peripheral fault.

Note

This description only applies to the bits where the address is occupied by a node.



8.15 Write Extended ID1 Code

The `Write Extended ID1 Code` command writes the ID1 code of the node with the address "0." The command is used for identification and is not used in the normal operation of the gateway.

The gateway forwards the ID1 code to the node without performing a plausibility check.

No command response payload data is required.

The length of the payload data of the `Write Extended ID1 Code` command is 1 byte. The payload data is in the format shown in the tables below.

Format of the Command Request

Byte	Bit 7	Bit 6	Bit 5	Bit 4	Bit 3	Bit 2	Bit 1	Bit 0
0	0x3F							
1	T	-	-	-	-	-	-	Segment
2	-				ID1 code			

Table 8.28

Format of the Command Response

Byte	Bit 7	Bit 6	Bit 5	Bit 4	Bit 3	Bit 2	Bit 1	Bit 0
0	0x3F							
1	T	Error code						

Table 8.29

8.16 Set Permanent Parameter

The `Set Permanent Parameter` command configures a parameter value for the specified node. The parameter is stored in the gateway in non-volatile memory.

The configured node parameter is sent to the node when the gateway is switched on.

The length of the payload data of the `Set Permanent Parameter` command is 2 bytes. The payload data is in the format shown in the tables below.

Format of the Command Request

Byte	Bit 7	Bit 6	Bit 5	Bit 4	Bit 3	Bit 2	Bit 1	Bit 0
0	0x43							
1	T	-	-	-	-	-	-	Segment
2	-		A/B	ASi node address				
3	-				PP3 ¹	PP2	PP1	PP0

Table 8.30

1. PP = Permanent parameter

Format of the Command Response

Byte	Bit 7	Bit 6	Bit 5	Bit 4	Bit 3	Bit 2	Bit 1	Bit 0
0	0x43							
1	T	Error code						

Table 8.31

8.17 Get LPS

The `Get LPS` command reads the list of projected nodes.

No command request payload data is required.

The length of the payload data of the `Get LPS` command response is 8 bytes. The format of the payload data is shown in the tables below.

Format of the Command Request

Byte	Bit 7	Bit 6	Bit 5	Bit 4	Bit 3	Bit 2	Bit 1	Bit 0
0	0x44							
1	T	0	-	-	-	-	-	Segment

Table 8.32

Format of the Command Response

Byte	Bit 7	Bit 6	Bit 5	Bit 4	Bit 3	Bit 2	Bit 1	Bit 0
0	0x44							
1	T	Error code						
2	7A/7	6A/6	5A/5	4A/4	3A/3	2A/2	1A/1	-
...
6	7B	6B	5B	4B	3B	2B	1B	-
...
9	31B	30B	29B	28B	27B	26B	25B	24B

Table 8.33

Bit

- 0 A node at the address corresponding to the bit is not expected.
- 1 A node at the address corresponding to the bit is expected.

Note

This description only applies to the bits where the address is occupied by a node.

8.18 Get LAS

The `Get LAS` command reads a list of enabled nodes.

No command request payload data is required.

The length of the payload data of the `Get LAS` command response is 8 bytes. The format of the payload data is shown in the tables below.

Format of the Command Request

Byte	Bit 7	Bit 6	Bit 5	Bit 4	Bit 3	Bit 2	Bit 1	Bit 0
0	0x45							
1	T	0	-	-	-	-	-	Segment

Table 8.34



Format of the Command Response

Byte	Bit 7	Bit 6	Bit 5	Bit 4	Bit 3	Bit 2	Bit 1	Bit 0
0	0x45							
1	T	Error code						
2	7A/7	6A/6	5A/5	4A/4	3A/3	2A/2	1A/1	-
...
6	7B	6B	5B	4B	3B	2B	1B	-
...
9	31B	30B	29B	28B	27B	26B	25B	24B

Table 8.35

Bit

- 0** A node at the address corresponding to the bit is disabled.
- 1** A node at the address corresponding to the bit is enabled.



Note

This description only applies to the bits where the address is occupied by a node.

8.19

Get LDS

The `Get LDS` command reads a list of detected nodes.

No command response payload data is required.

The length of the payload data of the `Get LDS` command is 8 bytes. The format of the payload data is shown in the tables below.

Format of the Command Request

Byte	Bit 7	Bit 6	Bit 5	Bit 4	Bit 3	Bit 2	Bit 1	Bit 0
0	0x46							
1	T	0	-	-	-	-	-	Segment

Table 8.36

Format of the Command Response

Byte	Bit 7	Bit 6	Bit 5	Bit 4	Bit 3	Bit 2	Bit 1	Bit 0
0	0x46							
1	T	Error code						
2	7A/7	6A/6	5A/5	4A/4	3A/3	2A/2	1A/1	-
...
6	7B	6B	5B	4B	3B	2B	1B	-
...
9	31B	30B	29B	28B	27B	26B	25B	24B

Table 8.37

Bit

- 0 A node at the address corresponding to the bit is not detected.
- 1 A node at the address corresponding to the bit is detected.



Note

This description only applies to the bits that are occupied by the address of a node.

8.20 Get Flags

The `Get Flags` command reads information about the state of the nodes and the segment.

No command response payload data is required.

The length of the payload data of the `Get Flags` command is 3 bytes. The payload data is in the format shown in the tables below.

Format of the Command Request

Byte	Bit 7	Bit 6	Bit 5	Bit 4	Bit 3	Bit 2	Bit 1	Bit 0
0	0x47							
1	T	-	-	-	-	-	-	Segment

Table 8.38

Format of the Command Response

Byte	Bit 7	Bit 6	Bit 5	Bit 4	Bit 3	Bit 2	Bit 1	Bit 0
0	0x47							
1	T	Error code						
2	-	-	-	-	-	-	-	Peripheral OK
3	Offline Ready	APF/not APO	Normal Operation Active	Configuration Active	Auto Address Available	Auto Address Assign	LDS.0	Config OK
4	-	-	-	-	-	Auto Address Enable	Offline	Data Exchange Active

Table 8.39

Flags

Abbreviation	Name	Description
Pok	Periphery_Ok	The flag is set if no node signals a peripheral fault.
S0	LDS.0	The flag is set if a node occupies the address 0.
AAs	Auto_Address_Assign	The flag is set if automatic addressing is possible.
AAv	Auto_Address_Available	The flag is set if automatic addressing can be performed. Exactly one node is out of operation.
CA	Configuration_Active	The flag is set in configuration mode and not set in protected mode.
NA	Normal_Operation_Active	The flag is set if the gateway is in normal operation.

2023-06

Abbrevia- tion	Name	Description
APF	APF	The flag is set if the voltage on the AS-i segment is too low.
OR	Offline_Ready	The flag is set if the gateway is in offline mode.
Cok	Config_Ok	The flag is set if the target configuration (= projected configuration) and the actual configuration match.
AAe	Auto_Address_Enable	The flag indicates whether automatic addressing is blocked or enabled by the user.
OL	Offline	The flag is set if the offline operating state should be adopted or has already been adopted.
DX	Data_Exchange_Active	The flag enables data exchange with the nodes in the Data Exchange Phase. If the bit is not set, the exchange of process data with the nodes is blocked. Read ID telegrams are sent instead of data telegrams. The bit is set by the gateway when it enters the offline phase.

Table 8.40

8.21 Set Data Exchange Active

The `Set Data Exchange Active` command enables the process data exchange between the gateway and the nodes.

The length of the payload data of the `Set Data Exchange Active` command is 1 byte. The payload data is in the format shown in the tables below.

Format of the Command Request

Byte	Bit 7	Bit 6	Bit 5	Bit 4	Bit 3	Bit 2	Bit 1	Bit 0
0	0x48							
1	T	-	-	-	-	-	-	Segment
2	-	-	-	-	-	-	-	Data exchange active flag

Table 8.41

Data Exchange Active Flag

- 0 Resets the flag on the gateway.
- 1 Sets the flag on the gateway.

Format of the Command Response

Byte	Bit 7	Bit 6	Bit 5	Bit 4	Bit 3	Bit 2	Bit 1	Bit 0
0	0x48							
1	T	Error code						

Table 8.42

8.22 Get Delta List

The `Get Delta List` command reads a list of nodes with configuration errors.

No command request payload data is required.

The length of the payload data of the `Get Delta List` command response is 8 bytes. The format of the payload data is shown in the tables below.

Format of the Command Request

Byte	Bit 7	Bit 6	Bit 5	Bit 4	Bit 3	Bit 2	Bit 1	Bit 0
0	0x57							
1	T	0	-	-	-	-	-	Line

Table 8.43

Format of the Command Response

Byte	Bit 7	Bit 6	Bit 5	Bit 4	Bit 3	Bit 2	Bit 1	Bit 0
0	0x57							
1	T	Error code						
2	7A/7	6A/6	5A/5	4A/4	3A/3	2A/2	1A/1	-
...
6	7B	6B	5B	4B	3B	2B	1B	-
...
9	31B	30B	29B	28B	27B	26B	25B	24B

Table 8.44

Bit

- 0** The expected and detected node configurations match at the address specified by the bit.
- 1** The expected and detected node configurations do not match at the address specified by the bit.

Note

This description only applies to the bits that are occupied by the address of a node.



8.23 WRITE_74_75_PARAMETER

You can use the `WRITE_74_75_PARAMETER` command to write parameters to AS-Interface nodes with the S-7.4 profile.

Depending on the AS-Interface node, parameters have different effects on the application.

The AS-Interface node determines the length of a parameter character string. The character string can be up to 220 bytes in length according to the AS-Interface-3 specification.



Note

This command has an unusually long execution time.

Format of the Command Request

Byte	Bit 7	Bit 6	Bit 5	Bit 4	Bit 3	Bit 2	Bit 1	Bit 0
0	0x5A							
1	T	-	-	-	-	-	-	Segment
2	-		A/B	AS-Interface node address				
3	-							
4	Payload data length							
5	Data byte 1							
6	Data byte 2 ¹							
...	...							
x+4	Data byte x ¹ <Default ↯ Font>							

Table 8.45

1. Optional



Note

The `WRITE_74_75_PARAMETER` command receives no response.

8.24 READ_74_75_PARAM

You can use the `READ_74_75_PARAMETER` command to read parameters on AS-Interface nodes with the S-7.4 profile.

You can use the read parameter character string to check the configuration of the relevant application.

The AS-Interface node determines the length of a parameter character string. The character string can be up to 220 bytes long under the AS-Interface-3 specification.



Note

This command has an unusually long execution time.

Format of the Command Request

Byte	Bit 7	Bit 6	Bit 5	Bit 4	Bit 3	Bit 2	Bit 1	Bit 0
0	0x5B							
1	T	-	-	-	-	-	-	Segment
2	-		A/B	AS-Interface node address				
3	-							
4	Command length							

Table 8.46

Format of the Command Response

Byte	Bit 7	Bit 6	Bit 5	Bit 4	Bit 3	Bit 2	Bit 1	Bit 0
0	0x5B							
1	T	Error code						
2	Response length							
3	Data byte 1							
4	Data byte 2							
...	...							

Table 8.47

8.25 READ_74_75_ID

You can use the `READ_74_75_ID` command to read device-specific identification information on AS-Interface nodes with the S-7.4 profile.

You can use the read identification information to identify the AS-Interface node.

The length of an identification character string is determined by the AS-Interface node. The character string can be up to 220 bytes long under the AS-Interface-3 specification.



Note

This command has an unusually long execution time.

Format of the Command Request

Byte	Bit 7	Bit 6	Bit 5	Bit 4	Bit 3	Bit 2	Bit 1	Bit 0
0	0x5C							
1	T	-	-	-	-	-	-	Segment
2	-		A/B	AS-Interface node address				
3	-							

Table 8.48

Format of the Command Response

Byte	Bit 7	Bit 6	Bit 5	Bit 4	Bit 3	Bit 2	Bit 1	Bit 0
0	0x5C							
1	T	Error code						
2	Response length							
3	Data byte 1							
4	Data byte 2							
...	...							

Table 8.49

Table 8.50								
------------	--	--	--	--	--	--	--	--

8.26 READ_74_DIAG

You can use the `READ_74_DIAG` command to read diagnostic data on AS-Interface nodes with the S-7.4 profile.

You can use the read diagnostic data to check the status of the relevant respective node and the application.

The AS-Interface node determines the length of a diagnostic character string. The character string can be up to 220 bytes long under the AS-Interface-3 specification.



Note

This command has an unusually long execution time.

Format of the Command Request

Byte	Bit 7	Bit 6	Bit 5	Bit 4	Bit 3	Bit 2	Bit 1	Bit 0
0	0x5D							
1	T	-	-	-	-	-	-	Segment
2	-		A/B	AS-Interface node address				
3	-							

Table 8.51

Format of the Command Response

Byte	Bit 7	Bit 6	Bit 5	Bit 4	Bit 3	Bit 2	Bit 1	Bit 0
0	0x5C							
1	T	Error code						
2	Response length							
3	Data byte 1							
4	Data byte 2							
...	...							

Table 8.52

Table 8.53								
------------	--	--	--	--	--	--	--	--

8.27 TRANSFER_75

You can use the `TRANSFER_75` command to read serial data on AS-Interface nodes with the S-7.5 profile.

The serial data exchange is defined with commands. See "Commands for Combined Transaction Type 2 CTT2" on page 156.

The commands supported are device-specific. Refer to the manual of your AS-Interface node for the supported commands.

The AS-Interface node determines the length of a character string for data exchange. The character string can be up to 220 bytes long under the AS-Interface-3 specification.



Note

This command has an unusually long execution time.

Format of the Command Request

Byte	Bit 7	Bit 6	Bit 5	Bit 4	Bit 3	Bit 2	Bit 1	Bit 0
0	0x5E							
1	T	-	-	-	-	-	-	Segment
2	-		A/B	AS-Interface node address				
3	-							
4	Command length							
5	CTT2 command							
6	Object index							
7	CTT2 command length							
8	Data byte 1 ¹							
9	Data byte 2 ¹ <Default - ¹ Font>							
...	...							

Table 8.54

1. if required

Format of the Command Response

Byte	Bit 7	Bit 6	Bit 5	Bit 4	Bit 3	Bit 2	Bit 1	Bit 0
0	0x5E							
1	T	Error code						
2	Response length							
3	Data byte 1							
4	Data byte 2							
...	...							

Table 8.55

Commands for Combined Transaction Type 2 CTT2

Cyclic Commands

Code [dec]	Command/Response	followed by
0	Retrieve cyclic data from the node	1 ... 8 byte node data ¹
1	Send cyclic data to nodes	1 ... 8 byte master data ¹ <Default → Font>

Table 8.56

1. Mandatory field if the data exists

Three acyclic services are defined below. Please refer to the device documentation for the commands supported by your device.

Acyclic Commands

Service	Code [dec]	Command/Response	followed by
Standard	16 80 166	Read request Read response OK Read response not OK	Index, length specification Standard error code
	17 81 145	Write request Write response OK Write response not OK	Index, length specifications, data Standard error code
Seller-specific	18 82 146	Read request Read response OK Read response not OK	Index, length specification Standard error code
	19 83 147	Write request Write response OK Write response not OK	Index, length specifications, data Standard error code
	22 24 88 152	Selective read request from buffer Selective read request Selective read response OK Selective read response not OK	Index, subindex , length specifications index, subindex Length specifications for data error object
	23 25 89 153	Selective write request in the buffer Selective write request Response to selective write OK Response to selective write not OK	Index, subindex , length specification, data index, subindex, Length specification, data block length of error object
	29 93 157	Replacement request Replacement response OK Replacement response not OK	Index, read length, write length, write data, read data, error object
Equipment group	20 84 148	Read request Read response OK Read response not OK	Index, length specification Standard error code
	21 85 149	Write request Write response OK Write response not OK	Index, length specifications, data Standard error code
	31 26 90 154	Selective read request from buffer Selective read request Selective read response OK Selective read response not OK	Index, subindex , length specifications index, subindex Length specifications for data error object
	32 27 91 155	Selective write request in the buffer Selective write request Response to selective write OK Response to selective write not OK	Index, subindex , length specification, data index, subindex, Length specification, data block length of error object
	30 94 158	Replacement request Replacement response OK Replacement response not OK	Index, read length, write length, write data, read data, error object

Table 8.57

All indices of the acyclic standard services are reserved. Indices 0 (ID object) and 1 (diagnostic object) are mandatory, index 80_{hex} (equipment group) is optional.

If the node receives an unknown request, the node responds with the default read response code 144_{dec}, followed by the default error code (3).

8.28 Get LCS

The `Get LCS` command reads a list of nodes that have caused at least one configuration error since the gateway was powered on or since the last time the list was read.

No command request payload data is required.

The length of the payload data of the `Get LCS` command response is 8 bytes. The format of the payload data is shown in the tables below.

Format of the Command Request

Byte	Bit 7	Bit 6	Bit 5	Bit 4	Bit 3	Bit 2	Bit 1	Bit 0
0	0x60							
1	T	0	-	-	-	-	-	Segment

Table 8.58

Format of the Command Response

Byte	Bit 7	Bit 6	Bit 5	Bit 4	Bit 3	Bit 2	Bit 1	Bit 0
0	0x60							
1	T	Error code						
2	7A/7	6A/6	5A/5	4A/4	3A/3	2A/2	1A/1	-
...
6	7B	6B	5B	4B	3B	2B	1B	-
...
9	31B	30B	29B	28B	27B	26B	25B	24B

Table 8.59

Bit

- 0** A node at the address specified by the bit is enabled.
- 1** A node at the address specified by the bit is corrupted, i.e., a previously enabled node is disabled. The value is not reset until a user explicitly reads the LCS node list.

Note

This description only applies to the bits that are occupied by the address of a node.



8.29 Get Auto Address Enable

The `Get Auto Address Enable` command returns the status of automatic addressing. No command request payload data is required.

The length of the payload data of the `Get Auto Address Enable` command response is 1 byte. The payload data is in the format shown in the tables below.

Format of the Command Request

Byte	Bit 7	Bit 6	Bit 5	Bit 4	Bit 3	Bit 2	Bit 1	Bit 0
0	0xE1							
1	T	-	-	-	-	-	-	Segment

Table 8.60

Format of the Command Response

Byte	Bit 7	Bit 6	Bit 5	Bit 4	Bit 3	Bit 2	Bit 1	Bit 0
0	0xE1							
1	T	Error code						
2	-	-	-	-	-	-	-	Auto Address Enable flag

Table 8.61

Auto Address Enable Flag

- 0 Automatic addressing is disabled
- 1 Automatic addressing is enabled

8.30 Set Motor Control (G20) Config

In addition to the AS-Interface parameters for maximum speed and direction of rotation, "G20" series AS-Interface nodes also have an adjustable deceleration and acceleration ramp.

The `Set Motor Control (G20) Config` command overwrites the current configuration of the addressed node. The command is only effective for active nodes that understand the "G20 motor control" protocol.

The length of the payload data of the `Set Motor Control (G20) Config` command is 1 byte. The payload data is in the format shown in the tables below.

Refer to the manual of the relevant G20 module for details of the configuration.

Format of the Command Request

Byte	Bit 7	Bit 6	Bit 5	Bit 4	Bit 3	Bit 2	Bit 1	Bit 0
0	0xE2							
1	T	-	-	-	-	-	-	Segment
2	-		A/B	AS-Interface node address				
3	Config Size (n 1 .. 16)							
4					Config 0			
...					...			
...					Config n-1 ¹			

Table 8.62

1. $n \leq 16$

Format of the Command Response

Byte	Bit 7	Bit 6	Bit 5	Bit 4	Bit 3	Bit 2	Bit 1	Bit 0
0	0xE2							
1	T	Error code						

Table 8.63

Error code

- 0** Execution OK
- ≠ 0** An error occurred during execution
- 0x21** Node not present

9 Annex B: PROFINET Record Commands and Data Layout

9.1 Read IDI 0x01

You can use the `Read IDI` function to read input data images from the gateway.



RecordDataRead Request

1. Map the `Read IDI` function to the `RecordDataRead` index 0x01.
2. Assign an address to subslot 1 of the required AS-Interface segment.
3. Parameters of the `RecordDataRead` request:
 1. Index = 0x01
 2. Slot = 0 or 100
 - 0 = AS-Interface segment 1
 - 100 = AS-Interface segment 2
 3. Subslot = 0x01

RecordDataRead Response

Byte	Bit 7	Bit 6	Bit 5	Bit 4	Bit 3	Bit 2	Bit 1	Bit 0
0	0							
1	0							
2	-				Node 1/1A			
3	Node 2/2A				Node 3/3A			
...			
17	Node 30/30A				Node 31/31A			
18	-				Node 1B			
19	Node 2B				Node 3B			
...			
33	Node 30B				Node 31B			
34	-							
35	-				PNIO status			

Table 9.1

PNIO status

- OK** Data has been written
- NOK** Data has not been written

9.2 Write ODI 0x02

You can use the `Write ODI` function to write output data images (ODI) to the gateway.



RecordDataWrite Request

1. Map the `Write ODI` function to the `RecordDataWrite` index 0x02.
2. Assign an address to subslot 1 of the required AS-Interface segment.
3. Parameters of the `RecordDataWrite` request:
 1. Index = 0x02
 2. Slot = 0 or 100
 - 0 = AS-Interface segment 1
 - 100 = AS-Interface segment 2
 3. Subslot = 0x01

Data

Byte	Bit 7	Bit 6	Bit 5	Bit 4	Bit 3	Bit 2	Bit 1	Bit 0
0	0							
1	0							
2	-				Node 1/1A			
3	Node 2/2A				Node 3/3A			
...	...							
17	Node 30/30A				Node 31/31A			
18	-				Node 1B			
19	Node 2B				Node 3B			
...	...							
33	Node 30B				Node 31B			
34	-							
35	-							

Table 9.2

RecordDataWrite Response

The response includes the PNIO status. The PNIO status corresponds to the AS-Interface status.

PNIO Status

- OK** Data has been written
- NOK** Data has not been written

9.3 Set Permanent Parameter

You can use the `Set Permanent Parameter` function to set the parameters of the specified node.

Format of the RecordDataWrite Request

Byte	Bit 7	Bit 6	Bit 5	Bit 4	Bit 3	Bit 2	Bit 1	Bit 0
0	0x03							
1	T	-	-	-	-	-	-	Segment
2	-			AS-Interface node address				
3	A/B							
4					PA3 ¹	PA2	PA1	PA0

Table 9.3

1. PA = Parameter image

Format of the RecordDataRead Response

Byte	Bit 7	Bit 6	Bit 5	Bit 4	Bit 3	Bit 2	Bit 1	Bit 0
0	0x03							
1	T	Error code						
2	PNIO Status							

Table 9.4

PNIO Status

- OK** Data has been written
- NOK** Data has not been written

9.4 Get Permanent Parameter 0x04

You can use the `Get Permanent Parameter` function to access the expected configuration data on the node.



RecordDataRead Request

1. Write the address of the desired node in index 0x44. See chapter 9.30.
2. Map the `Get Permanent Parameter` function to the `RecordDataRead` index 0x04.
3. Assign an address to subslot 1 of the required AS-Interface segment.
4. Parameters of the `RecordDataRead` request:
 1. Index = 0x04
 2. Slot = 0 or 100
 - 0 = AS-Interface segment 1
 - 100 = AS-Interface segment 2
 3. Subslot = 0x01

Format of the RecordDataRead Response

Byte	Bit 7	Bit 6	Bit 5	Bit 4	Bit 3	Bit 2	Bit 1	Bit 0
0	0							
1	0							
2	-				PA3 ¹	PA2	PA1	PA0
3	-							

Table 9.5

1. PA = Parameter image

9.5 Read Parameter 0x06

You can use the `Read Parameter` function to call up the current parameters of one AS-Interface node at a time.



RecordDataRead Request

1. Write the address of the desired node in index 0x44. See chapter 9.30.
2. Map the `Read Parameter` function to the `RecordDataRead` index 0x06.
3. Assign an address to subslot 1 of the required AS-Interface segment.
4. Parameters of the `RecordDataRead` request:
 1. Index = 0x06
 2. Slot = 0 or 100
 - 0 = AS-Interface segment 1
 - 100 = AS-Interface segment 2
 3. Subslot = 0x01

Format of the RecordDataRead Response

Byte	Bit 7	Bit 6	Bit 5	Bit 4	Bit 3	Bit 2	Bit 1	Bit 0
0	0							
1	0							
2	-				PA3 ¹	PA2	PA1	PA0
3	-							

Table 9.6

1. PA = Parameter image

9.6 Set Permanent Configuration 0x08

You can use the `Set Permanent Configuration` function to set the configuration data of the specified node.



RecordDataWrite Request

1. Write the address of the desired node in index 0x44. See chapter 9.30.
2. Map the `Set Permanent Configuration` function to `RecordDataWrite` index 0x08.
3. Assign an address to subslot 1 of the required AS-Interface segment.
4. Parameters of the `RecordDataWrite` request:
 1. Index = 0x08
 2. Slot = 0 or 100
 - 0 = AS-Interface segment 1
 - 100 = AS-Interface segment 2
 3. Subslot = 0x01

Data

Byte	Bit 7	Bit 6	Bit 5	Bit 4	Bit 3	Bit 2	Bit 1	Bit 0
0	0							
1	0							
4	ID2 code				ID1 code			
5	ID code				IO code			

Table 9.7

RecordDataWrite Response

The response includes the PNIO status. The PNIO status corresponds to the AS-Interface status.

PNIO Status

- OK** Data has been written
- NOK** Data has not been written

9.7 Get Permanent Configuration 0x09

You can use the `Get Permanent Configuration` function to retrieve the expected configuration data on the node.



RecordDataRead Request

1. Write the address of the desired node in index 0x44. See chapter 9.30.
2. Map the `Get Permanent Configuration` function to the `RecordDataRead` index 0x09.
3. Assign an address to subslot 1 of the required AS-Interface segment.
4. Parameters of the `RecordDataRead` request:
 1. Index = 0x09
 2. Slot = 0 or 100
 - 0 = AS-Interface segment 1
 - 100 = AS-Interface segment 2
 3. Subslot = 0x01

Format of the RecordDataRead Response

Byte	Bit 7	Bit 6	Bit 5	Bit 4	Bit 3	Bit 2	Bit 1	Bit 0
0	0							
1	0							
2	ID2 code				ID1 code			
3	ID code				IO code			

Table 9.8

9.8 Read Actual Configuration 0x0B

You can use the `Read Actual Configuration` function to access the configuration data detected on the node.



RecordDataRead Request

1. Write the address of the desired node in index 0x44. See chapter 9.30.
2. Map the `Read Actual Configuration` function to the `RecordDataRead` index 0x0B.
3. Assign an address to subslot 1 of the required AS-Interface segment.
4. Parameters of the `RecordDataRead` request:
 1. Index = 0x0B
 2. Slot = 0 or 100
 - 0 = AS-Interface segment 1
 - 100 = AS-Interface segment 2
 3. Subslot = 0x01

Format of the RecordDataRead Response

Byte	Bit 7	Bit 6	Bit 5	Bit 4	Bit 3	Bit 2	Bit 1	Bit 0
0	0							
1	0							
2	ID2 code				ID1 code			

2023-06

Byte	Bit 7	Bit 6	Bit 5	Bit 4	Bit 3	Bit 2	Bit 1	Bit 0
3	ID code				IO code			

Table 9.9

9.9 Set LPS 0x0C

You can use the `Set LPS` function to store a list of the configured AS-Interface nodes.



RecordDataWrite Request

1. Map the `Set LPS` function to the `RecordDataWrite` index `0x0C`.
2. Assign an address to subslot 1 of the required AS-Interface segment.
3. Parameters of the `RecordDataWrite` request:
 1. Index = `0x0C`
 2. Slot = 0 or 100
 - 0 = AS-Interface segment 1
 - 100 = AS-Interface segment 2
 3. Subslot = `0x01`

Data

Byte	Bit 7	Bit 6	Bit 5	Bit 4	Bit 3	Bit 2	Bit 1	Bit 0
0	0							
1	0							
2	7A/7	6A/6	5A/5	4A/4	3A/3	2A/2	1A/1	-
...
6	7B	6B	5B	4B	3B	2B	1B	-
...
9	31B	30B	29B	28B	27B	26B	25B	24B
10	-							
11	-							

Table 9.10

RecordDataWrite Response

The response includes the PNOI status. The PNOI status corresponds to the AS-Interface status.

PNOI Status

- OK** Data has been written
- NOK** Data has not been written

9.10 Get LPS 0x0D

You can use the `Get LPS` function to check a list of the configured AS-Interface nodes.



RecordDataRead Request

1. Map the `Get LPS` function to the `RecordDataRead` index 0x0D.
2. Assign an address to subslot 1 of the required AS-Interface segment.
3. Parameters of the `RecordDataRead` request:
 1. Index = 0x0D
 2. Slot = 0 or 100
 - 0 = AS-Interface segment 1
 - 100 = AS-Interface segment 2
 3. Subslot = 0x01

Format of the RecordDataRead Response

Byte	Bit 7	Bit 6	Bit 5	Bit 4	Bit 3	Bit 2	Bit 1	Bit 0
0	0							
1	0							
2	7A/7	6A/6	5A/5	4A/4	3A/3	2A/2	1A/1	-
...
6	7B	6B	5B	4B	3B	2B	1B	-
...
9	31B	30B	29B	28B	27B	26B	25B	24B
10	-							
11	-				PNIO Status			

Table 9.11

PNIO Status

OK Data has been written

NOK Data has not been written

9.11 Get LAS 0x0E

You can use the `Get LAS` function to check a list of the enabled AS-Interface nodes.



RecordDataRead Request

1. Map the `Get LAS` function to the `RecordDataRead` index 0x0E.
2. Assign an address to subslot 1 of the required AS-Interface segment.
3. Parameters of the `RecordDataRead` request:
 1. Index = 0x0E
 2. Slot = 0 or 100
 - 0 = AS-Interface segment 1
 - 100 = AS-Interface segment 2
 3. Subslot = 0x01

Format of the RecordDataRead Response

Byte	Bit 7	Bit 6	Bit 5	Bit 4	Bit 3	Bit 2	Bit 1	Bit 0
0	0							
1	0							
2	7A/7	6A/6	5A/5	4A/4	3A/3	2A/2	1A/1	-
...
6	7B	6B	5B	4B	3B	2B	1B	-
...
9	31B	30B	29B	28B	27B	26B	25B	24B
10	-							
11	-				PNIO Status			

Table 9.12

PNIO Status

OK Data has been written

NOK Data has not been written

9.12 Get LDS 0x0F

You can use the `Get LDS` function to check a list of the available AS-Interface nodes.



RecordDataRead Request

1. Map the `Get LDS` function to the `RecordDataRead` index 0x0F.
2. Assign an address to subslot 1 of the required AS-Interface segment.
3. Parameters of the `RecordDataRead` request:
 1. Index = 0x0F
 2. Slot = 0 or 100
 - 0 = AS-Interface segment 1
 - 100 = AS-Interface segment 2
 3. Subslot = 0x01

Format of the RecordDataRead Response

Byte	Bit 7	Bit 6	Bit 5	Bit 4	Bit 3	Bit 2	Bit 1	Bit 0
0	0							
1	0							
2	7A/7	6A/6	5A/5	4A/4	3A/3	2A/2	1A/1	-
...
6	7B	6B	5B	4B	3B	2B	1B	-
...
9	31B	30B	29B	28B	27B	26B	25B	24B
10	-							
11	-				PNIO Status			

Table 9.13

PNIO Status

- OK** Data has been written
NOK Data has not been written

9.13 Get Flags 0x10

You can use the `Get Flags` function to check the status of the AS-Interface flags.

**RecordDataRead Request**

1. Map the `Get Flags` function to the `RecordDataRead` index 0x10.
2. Assign an address to subslot 1 of the required AS-Interface segment.
3. Parameters of the `RecordDataRead` request:
 1. Index = 0x10
 2. Slot = 0 or 100
 - 0 = AS-Interface segment 1
 - 100 = AS-Interface segment 2
 3. Subslot = 0x01

Format of the RecordDataRead Response

Byte	Bit 7	Bit 6	Bit 5	Bit 4	Bit 3	Bit 2	Bit 1	Bit 0
0	0							
1	0							
2	Offline Ready	APF/not APO	Normal Operation Active	Configuration Active	Auto Address Available	Auto Address Assign	LDS.0	Config OK
3	-	-	-	-	-	Offline	Data Exchange Active	Peripheral OK

Table 9.14

9.14 Set Operation Mode 0x11

You can use the `Set Operation Mode` function to define the operating mode of the gateway.

**RecordDataWrite Request**

1. Map the `Set Operation Mode` function to `RecordDataWrite` index 0x11.
2. Assign an address to subslot 1 of the required AS-Interface segment.
3. Parameters of the `RecordDataWrite` request:
 1. Index = 0x11
 2. Slot = 0 or 100
 - 0 = AS-Interface segment 1
 - 100 = AS-Interface segment 2
 3. Subslot = 0x01

Data

Byte	Bit 7	Bit 6	Bit 5	Bit 4	Bit 3	Bit 2	Bit 1	Bit 0
0	0							
1	0							
2	0	0	0	0	0	0	0	Flag
3	-							

Table 9.15

Flag

- 0b0** Switch to protected mode
- 0b1** Switch to configuration mode

RecordDataWrite Response

The response includes the PNOI status. The PNOI status corresponds to the AS-Interface status.

PNOI Status

- OK** Data has been written
- NOK** Data has not been written

9.15 Set Offline Mode 0x12

You can use the `Set Offline Mode` function to define the operating mode of the gateway.



RecordDataWrite Request

1. Map the `Set Offline Mode` function to RecordDataWrite index 0x12.
2. Assign an address to subslot 1 of the required AS-Interface segment.
3. Parameters of the RecordDataWrite request:
 1. Index = 0x12
 2. Slot = 0 or 100
 - 0 = AS-Interface segment 1
 - 100 = AS-Interface segment 2
 3. Subslot = 0x01

Data

Byte	Bit 7	Bit 6	Bit 5	Bit 4	Bit 3	Bit 2	Bit 1	Bit 0
0	0							
1	0							
2	0	0	0	0	0	0	0	Flag
3	-							

Table 9.16

Flag

- 0b0** Switch to online mode
- 0b1** Switch to offline mode

RecordDataWrite Response

The response includes the PNOI status. The PNOI status corresponds to the AS-Interface status.

PNOI Status

- OK** Data has been written
- NOK** Data has not been written

9.16 Set Data Exchange Active 0x13

You can use the `Set Data Exchange Active` function to control data exchange between the gateway and the nodes.



RecordDataWrite Request

1. Map the `Set Data Exchange Active` function to `RecordDataWrite` index 0x13.
2. Assign an address to subslot 1 of the required AS-Interface segment.
3. Parameters of the `RecordDataWrite` request:
 1. Index = 0x13
 2. Slot = 0 or 100
 - 0 = AS-Interface segment 1
 - 100 = AS-Interface segment 2
 3. Subslot = 0x01

Format of the RecordDataWrite Request

Byte	Bit 7	Bit 6	Bit 5	Bit 4	Bit 3	Bit 2	Bit 1	Bit 0
0	0							
1	T							
2	0	0	0	0	0	0	0	Flag
3	-							

Table 9.17

Flag

- 0b0** Data Exchange active
- 0b1** Data exchange disabled

RecordDataWrite Response

The response includes the PNOI status. The PNOI status corresponds to the AS-Interface status.

PNOI Status

- OK** Data has been written
- NOK** Data has not been written

9.17 Change Node Address 0x14

You can use the `Change Node Address` function to change the address of a node.



RecordDataWrite Request

1. Map the `Change Node Address` function to the `RecordDataWrite` index 0x14.
2. Assign an address to subslot 1 of the required AS-Interface segment.
3. Parameters of the `RecordDataWrite` request:
 1. Index = 0x14
 2. Slot = 0 or 100
 - 0 = AS-Interface segment 1
 - 100 = AS-Interface segment 2
 3. Subslot = 0x01

Data

Byte	Bit 7	Bit 6	Bit 5	Bit 4	Bit 3	Bit 2	Bit 1	Bit 0
0	0							
1	0							
2	-		A/B	Previous node address				
3	-		A/B	New node address				

Table 9.18

RecordDataWrite Response

The response includes the PNOI status. The PNOI status corresponds to the AS-Interface status.

PNOI Status

- OK** Data has been written
- NOK** Data has not been written

9.18 Set Auto Address Enable 0x15

You can use the `Set Auto Address Enable` function to enable automatic address assignment.



RecordDataWrite Request

1. Map the `Set Auto Address Enable` function to `RecordDataWrite` index 0x15.
2. Assign an address to subslot 1 of the required AS-Interface segment.
3. Parameters of the `RecordDataWrite` request:
 1. Index = 0x15
 2. Slot = 0 or 100
 - 0 = AS-Interface segment 1
 - 100 = AS-Interface segment 2
 3. Subslot = 0x01

Data

Byte	Bit 7	Bit 6	Bit 5	Bit 4	Bit 3	Bit 2	Bit 1	Bit 0
0	0							
1	0							
2	0	0	0	0	0	0	0	Flag
3	-							

Table 9.19

Flag

0b0 Automatic address assignment disabled

0b1 Automatic address assignment enabled

RecordDataWrite Response

The response includes the PNIO status. The PNIO status corresponds to the AS-Interface status.

PNIO Status

OK Data has been written

NOK Data has not been written

9.19 Get Auto Address Enable 0x15

You can use the `Get Auto Address Enable` function to query the status of the automatic address assignment.



RecordDataRead Request

1. Map the `Get Auto Address Enable` function to the `RecordDataRead` index 0x15.
2. Assign an address to subslot 1 of the required AS-Interface segment.
3. Parameters of the `RecordDataRead` request:
 1. Index = 0x15
 2. Slot = 0 or 100
 - 0 = AS-Interface segment 1
 - 100 = AS-Interface segment 2
 3. Subslot = 0x01

RecordDataRead Response

Byte	Bit 7	Bit 6	Bit 5	Bit 4	Bit 3	Bit 2	Bit 1	Bit 0
0	0							
1	0							
2	0	0	0	0	0	0	0	Flag
3	-							
4	-				PNIO Status			

Table 9.20

Flag

- 0b0** Automatic address assignment disabled
- 0b1** Automatic address assignment enabled

PNIO Status

- OK** Data has been written
- NOK** Data has not been written

9.20 Get LPF 0x17

You can use the `Get LPF` function to read a list of peripheral faults (= List of Periphery Faults LPF) from the gateway.



RecordDataRead Request

1. Map the `Get LPF` function to the `RecordDataRead` index 0x017.
2. Assign an address to subslot 1 of the required AS-Interface segment.
3. Parameters of the `RecordDataRead` request:
 1. Index = 0x17
 2. Slot = 0 or 100
 - 0 = AS-Interface segment 1
 - 100 = AS-Interface segment 2
 3. Subslot = 0x01

RecordDataRead Response

Byte	Bit 7	Bit 6	Bit 5	Bit 4	Bit 3	Bit 2	Bit 1	Bit 0
0	0							
1	0							
2	7A/7	6A/6	5A/5	4A/4	3A/3	2A/2	1A/1	-
...
6	7B	6B	5B	4B	3B	2B	1B	-
...
9	31B	30B	29B	28B	27B	26B	25B	24B
10	-							
11	-				PNIO Status			

Table 9.21

Bit

- 0** At the address specified by the bit, either an active node has no peripheral fault, a node is not enabled, or a node is not present.
- 1** A node at the address corresponding to the bit reports a peripheral fault.

Note

This description only applies to the bits where the address is occupied by a node.



PNIO Status

- OK** Data has been written
NOK Data has not been written

9.21 Write ID1 Code 0x18

You can use the `Write ID1 Code` function to change the ID1 code of the node to the AS-Interface address 0.

**RecordDataWrite Request**

1. Map the `Write ID1 Code` function to the `RecordDataWrite` index 0x18.
2. Assign an address to subslot 1 of the required AS-Interface segment.
3. Parameters of the `RecordDataWrite` request:
 1. Index = 0x18
 2. Slot = 0 or 100
 - 0 = AS-Interface segment 1
 - 100 = AS-Interface segment 2
 3. Subslot = 0x01

Data

Byte	Bit 7	Bit 6	Bit 5	Bit 4	Bit 3	Bit 2	Bit 1	Bit 0
0	0							
1	0							
2	ID1 code							
3	-							

Table 9.22

RecordDataWrite Response

The response includes the PNOI status. The PNOI status corresponds to the AS-Interface status.

PNIO Status

- OK** ID1 code changed
SND Node not detected

9.22 Read AIDI 0x19

You can use the `Read AIDI` function to read analog input data images from the gateway.



RecordDataRead Request

1. Map the `Read AIDI` function to the `RecordDataRead` index 0x019.
2. Assign an address to subslot 1 of the required AS-Interface segment.
3. Parameters of the `RecordDataRead` request:
 1. Index = 0x19
 2. Slot = 0 or 100
 - 0 = AS-Interface segment 1
 - 100 = AS-Interface segment 2
 3. Subslot = 0x01

RecordDataRead Response

Byte	Bit 7	Bit 6	Bit 5	Bit 4	Bit 3	Bit 2	Bit 1	Bit 0
0	0							
1	0							
2	Analog input data node 1, channel 0 or Analog input data node 1A, channel 0							
3								
4	Analog input data node 1, channel 1 or Analog input data node 1A, channel 1							
5								
6	Analog input data node 1, channel 2 or Analog input data node 1B, channel 0							
7								
8	Analog input data node 1, channel 3 or Analog input data node 1B, channel 1							
9								
10	Analog input data node 2, channel 0 or Analog input data node 2A, channel 0							
11								
...	...							
242	Analog input data node 31, channel 0 or Analog input data node 31A, channel 0							
243								
244	Analog input data node 31, channel 1 or Analog input data node 31A, channel 1							
245								
246	Analog input data node 31, channel 2 or Analog input data node 31B, channel 0							
247								
248	Analog input data node 31, channel 3 or Analog input data node 31B, channel 1							
249								
250	-							
251	-					PNIO Status		

Table 9.23

PNIO Status

- OK** Data has been written
- NOK** Data has not been written

9.23 Write AODI 0x1A

You can use `Write AODI` function to write analog output data images to the gateway.



RecordDataWrite Request

1. Map the `Write AODI` function to the `RecordDataWrite` index 0x1A.
2. Assign an address to subslot 1 of the required AS-Interface segment.
3. Parameters of the `RecordDataWrite` request:
 1. Index = 0x1A
 2. Slot = 0 or 100
 - 0 = AS-Interface segment 1
 - 100 = AS-Interface segment 2
 3. Subslot = 0x01

Data

Byte	Bit 7	Bit 6	Bit 5	Bit 4	Bit 3	Bit 2	Bit 1	Bit 0
0	0							
1	0							
2	Analog output data node 1, channel 0 or Analog output data node 1A, channel 0							
3								
4	Analog output data node 1, channel 1 or Analog output data node 1A, channel 1							
5								
6	Analog output data node 1, channel 2 or Analog output data node 1B, channel 0							
7								
8	Analog output data node 1, channel 3 or Analog output data node 1B, channel 1							
9								
10	Analog output data node 2, channel 0 or Analog output data node 2A, channel 0							
11								
...	...							
242	Analog output data node 31, channel 0 or Analog output data node 31A, channel 0							
243								
244	Analog output data node 31, channel 1 or Analog output data node 31A, channel 1							
245								
246	Analog output data node 31, channel 2 or Analog output data node 31B, channel 0							
247								
248	Analog output data node 31, channel 3 or Analog output data node 31B, channel 1							
249								
250	-							
251	-							

Table 9.24

RecordDataWrite Response

The response includes the PNIO status. The PNIO status corresponds to the AS-Interface status.

PNIO Status

- OK** Data has been written
- NOK** Data has not been written

9.24 Get Delta List 0x40

You can use the `Get Delta List` function to request the delta list.



RecordDataRead Request

1. Map the `Get Delta List` function to the `RecordDataRead` index 0x40.
2. Assign an address to subslot 1 of the required AS-Interface segment.
3. Parameters of the `RecordDataRead` request:
 1. Index = 0x40
 2. Slot = 0 or 100
 - 0 = AS-Interface segment 1
 - 100 = AS-Interface segment 2
 3. Subslot = 0x01

Format of the RecordDataRead Response

Byte	Bit 7	Bit 6	Bit 5	Bit 4	Bit 3	Bit 2	Bit 1	Bit 0
0	0							
1	0							
2	7A/7	6A/6	5A/5	4A/4	3A/3	2A/2	1A/1	-
...
6	7B	6B	5B	4B	3B	2B	1B	-
...
9	31B	30B	29B	28B	27B	26B	25B	24B
10	-							
11	-				PNIO Status			

Table 9.25

PNIO Status

- OK** Data has been written
- NOK** Data has not been written

9.25 Get LCS 0x41

You can use the `Get LCS` function to check a list of the corrupted AS-Interface nodes (= List of Corrupted Nodes LCS).



RecordDataRead Request

1. Map the `Get LCS` function to the `RecordDataRead` index 0x41.
2. Assign an address to subslot 1 of the required AS-Interface segment.
3. Parameters of the `RecordDataRead` request:
 1. Index = 0x41
 2. Slot = 0 or 100
 - 0 = AS-Interface segment 1
 - 100 = AS-Interface segment 2
 3. Subslot = 0x01

Format of the RecordDataRead Response

Byte	Bit 7	Bit 6	Bit 5	Bit 4	Bit 3	Bit 2	Bit 1	Bit 0
0	0							
1	0							
2	7A/7	6A/6	5A/5	4A/4	3A/3	2A/2	1A/1	-
...
6	7B	6B	5B	4B	3B	2B	1B	-
...
9	31B	30B	29B	28B	27B	26B	25B	24B
10	-							
11	-				PNIO Status			

Table 9.26

PNIO Status

- OK** Data has been written
- NOK** Data has not been written

9.26 Write Parameter 0x42

You can use the `Write Parameter` function to overwrite the current parameter value of a node.



RecordDataWrite Request

1. Write the address of the desired node in index 0x44. See chapter 9.30.
2. Map the `Write Parameter` function to the `RecordDataWrite` index 0x42.
3. Assign an address to subslot 1 of the required AS-Interface segment.
4. Parameters of the `RecordDataWrite` request:
 1. Index = 0x42
 2. Slot = 0 or 100
 - 0 = AS-Interface segment 1
 - 100 = AS-Interface segment 2
 3. Subslot = 0x01

Data

Byte	Bit 7	Bit 6	Bit 5	Bit 4	Bit 3	Bit 2	Bit 1	Bit 0
0	0							
1	0							
2					P3 ¹	P2	P1	P0
3	-							
4	-							

Table 9.27

1. P = Parameter

RecordDataWrite Response

The response includes the PNOI status. The PNOI status corresponds to the AS-Interface status.

PNOI Status

- OK** Data has been written
- NOK** Data has not been written

9.27 Read Node Response to Write Parameter 0x42

You can use the `Read Node Response to Write Parameter` function to retrieve the response for writing the parameters of one AS-Interface node at a time.



RecordDataRead Request

1. Write the address of the desired node in index 0x44. See chapter 9.30.
2. Map the `Read Node Response to Write Parameter` function to the `RecordDataRead` index 0x42.
3. Assign an address to subslot 1 of the required AS-Interface segment.

4. Parameters of the RecordDataRead request:

1. Index = 0x42
2. Slot = 0 or 100
 - 0 = AS-Interface segment 1
 - 100 = AS-Interface segment 2
3. Subslot = 0x01

Format of the RecordDataRead Response

Byte	Bit 7	Bit 6	Bit 5	Bit 4	Bit 3	Bit 2	Bit 1	Bit 0
0	0							
1	0							
2	-				Node response			
3	-							
4	-				PNIO Status			

Table 9.28

PNIO Status

OK Data has been written

NOK Data has not been written

9.28 Reset Node 0x43

You can use the `Reset Node` function to reset one AS-Interface node at a time.



RecordDataWrite Request

1. Write the address of the desired node in index 0x44. See chapter 9.30.
2. Map the `Reset Node` function to the RecordDataWrite index 0x43.
3. Assign an address to subslot 1 of the required AS-Interface segment.
4. Parameters of the RecordDataWrite request:
 1. Index = 0x43
 2. Slot = 0 or 100
 - 0 = AS-Interface segment 1
 - 100 = AS-Interface segment 2
 3. Subslot = 0x01

Data

Byte	Bit 7	Bit 6	Bit 5	Bit 4	Bit 3	Bit 2	Bit 1	Bit 0
0	0							
1	0							
2	-		AS-Interface node address					
3	-							

Table 9.29

RecordDataWrite Response

The response includes the PNIO status. The PNIO status corresponds to the AS-Interface status.

PNIO Status

OK Data has been written

NOK Data has not been written

9.29 Read Node Response to Reset Node 0x43

You can use the `Read Node Response to Reset Node` function to retrieve the response for resetting the parameters of one AS-Interface node at a time.



RecordDataRead Request

1. Write the address of the desired node in index 0x44. See chapter 9.30.
2. Map the `Read Node Response to Reset Node` function to the `RecordDataRead` index 0x43.
3. Assign an address to subslot 1 of the required AS-Interface segment.
4. Parameters of the `RecordDataRead` request:
 1. Index = 0x43
 2. Slot = 0 or 100
 - 0 = AS-Interface segment 1
 - 100 = AS-Interface segment 2
 3. Subslot = 0x01

Format of the RecordDataRead Response

Byte	Bit 7	Bit 6	Bit 5	Bit 4	Bit 3	Bit 2	Bit 1	Bit 0
0	0							
1	0							
2	-				Node response			
3	-							
4	-				PNIO Status			

Table 9.30

PNIO Status

OK Data has been written

NOK Data has not been written

9.30 Select Node 0x44

You can use the `Select Node` function to select one AS-Interface node at a time.



RecordDataWrite Request

1. Map the `Select Node` function to the `RecordDataWrite` index 0x44.
2. Assign an address to subslot 1 of the required AS-Interface segment.
3. Parameters of the `RecordDataWrite` request:
 1. Index = 0x44
 2. Slot = 0 or 100
 - 0 = AS-Interface segment 1
 - 100 = AS-Interface segment 2
 3. Subslot = 0x01

Data

Byte	Bit 7	Bit 6	Bit 5	Bit 4	Bit 3	Bit 2	Bit 1	Bit 0
0	0							
1	0							
2	-		AS-Interface node address					
3	-							

Table 9.31

RecordDataWrite Response

The response includes the PNOI status. The PNOI status corresponds to the AS-Interface status.

PNOI Status

- OK** Data has been written
NOK Data has not been written

9.31 Store Actual Parameters 0x45

You can use the `Store Actual Parameters` function to permanently save the current parameters.



RecordDataWrite Request

1. Map the `Store Actual Parameters` function to the `RecordDataWrite` index 0x45.
2. Assign an address to subslot 1 of the required AS-Interface segment.
3. Parameters of the `RecordDataWrite` request:
 1. Index = 0x45
 2. Slot = 0 or 100
 - 0 = AS-Interface segment 1
 - 100 = AS-Interface segment 2
 3. Subslot = 0x01

Data

Byte	Bit 7	Bit 6	Bit 5	Bit 4	Bit 3	Bit 2	Bit 1	Bit 0
0	0							
1	0							
2	0							1
3	0							

Table 9.32

RecordDataWrite Response

The response includes the PNOI status. The PNOI status corresponds to the AS-Interface status.

PNOI Status

OK Data has been written

NOK Data has not been written

9.32 Store Actual Configuration 0x46

You can use the `Store Actual Configuration` function to permanently save the current configuration.



RecordDataWrite Request

1. Map the `Store Actual Configuration` function to the `RecordDataWrite` index 0x46.
2. Assign an address to subslot 1 of the required AS-Interface segment.
3. Parameters of the `RecordDataWrite` request:
 1. Index = 0x46
 2. Slot = 0 or 100
 - 0 = AS-Interface segment 1
 - 100 = AS-Interface segment 2
 3. Subslot = 0x01

Data

Byte	Bit 7	Bit 6	Bit 5	Bit 4	Bit 3	Bit 2	Bit 1	Bit 0
0	0							
1	0							
2	0							1
3	0							

Table 9.33

RecordDataWrite Response

The response includes the PNOI status. The PNOI status corresponds to the AS-Interface status.

PNOI Status

OK Data has been written

NOK Data has not been written

9.33 Set Motor Control (G20) Config 0x47

In addition to the AS-Interface parameters for maximum speed and direction of rotation, "G20" series AS-Interface nodes also have an adjustable deceleration and acceleration ramp. You can use the `Set Motor Control (G20) Config` function to overwrite the parameters of the deceleration and acceleration ramps of the addressed node.



RecordDataWrite Request

1. Map the `Select Node` function to the `RecordDataWrite` index 0x44.
2. Map the `Set Motor Control (G20) Config` function to `RecordDataWrite` index 0x47.
3. Assign an address to subslot 1 of the required AS-Interface segment.
4. Parameters of the `RecordDataWrite` request:
 1. Index = 0x47
 2. Slot = 0 or 100
 - 0 = AS-Interface segment 1
 - 100 = AS-Interface segment 2
 3. Subslot = 0x01

Data

Byte	Bit 7	Bit 6	Bit 5	Bit 4	Bit 3	Bit 2	Bit 1	Bit 0
0	0							
1	0							
2	-				Config 0			
...	-				...			
...	-				Config n-1 ¹			

Table 9.34

1. $n \leq 16$

RecordDataWrite Response

The response includes the PNOI status. The PNOI status corresponds to the AS-Interface status.

PNOI Status

- OK** Data has been written
- NOK** Data has not been written

Your automation, our passion.

Explosion Protection

- Intrinsic Safety Barriers
- Signal Conditioners
- FieldConnex® Fieldbus
- Remote I/O Systems
- Electrical Ex Equipment
- Purge and Pressurization
- Industrial HMI
- Mobile Computing and Communications
- HART Interface Solutions
- Surge Protection
- Wireless Solutions
- Level Measurement

Industrial Sensors

- Proximity Sensors
- Photoelectric Sensors
- Industrial Vision
- Ultrasonic Sensors
- Rotary Encoders
- Positioning Systems
- Inclination and Acceleration Sensors
- Fieldbus Modules
- AS-Interface
- Identification Systems
- Displays and Signal Processing
- Connectivity

Pepperl+Fuchs Quality

Download our latest policy here:

www.pepperl-fuchs.com/quality

