

Box PC for Industrial Applications

BPC3200-*

Manual



With regard to the supply of products, the current issue of the following document is applicable:
The General Terms of Delivery for Products and Services of the Electrical Industry, published
by the Central Association of the Electrical Industry (Zentralverband Elektrotechnik und Elek-
troindustrie (ZVEI) e.V.) in its most recent version as well as the supplementary clause:
"Expanded reservation of proprietorship"

Worldwide

Pepperl+Fuchs Group
Lilienthalstr. 200
68307 Mannheim
Germany
Phone: +49 621 776 - 0
E-mail: info@de.pepperl-fuchs.com

North American Headquarters

Pepperl+Fuchs Inc.
1600 Enterprise Parkway
Twinsburg, Ohio 44087
USA
Phone: +1 330 425-3555
E-mail: sales@us.pepperl-fuchs.com

Asia Headquarters

Pepperl+Fuchs Pte. Ltd.
P+F Building
18 Ayer Rajah Crescent
Singapore 139942
Phone: +65 6779-9091
E-mail: sales@sg.pepperl-fuchs.com
<https://www.pepperl-fuchs.com>

1	History of the Manual	5
2	Introduction.....	6
2.1	Content of this Document.....	6
2.2	Manufacturer	6
2.3	Target Group, Personnel	6
2.4	Symbols Used	7
3	Product Description	8
3.1	Product Highlights.....	8
3.2	Application	9
3.3	Operating Systems	10
3.4	Firmware	11
3.5	Reference Documents	12
3.6	Technical Data.....	13
3.7	Expanded Technical Data.....	16
3.8	CPU & Performance	17
3.9	Preferred Types	17
3.10	Dimensions and Nameplates.....	18
4	Installation.....	21
4.1	General Installation Requirements	21
4.2	Mounting.....	21
4.2.1	Mounting Positions	22
4.3	Electrical Installation.....	26
4.4	Equipotential Bonding	27
4.4.1	Power Limitations.....	28
4.5	Connecting the Power Supply	29
4.6	I/O Connection	29
4.7	Commissioning	38
4.8	Information on I/O Devices	38
4.9	Connecting External Monitors.....	39
5	Maintenance.....	40
5.1	Opening the device.....	40
5.2	Internal Design of the Device	41

5.3	Settings when exchanging a TCU/PCU or DMU within a VisuNet FLX System or Panel	45
5.4	BIOS Settings	47
5.4.1	Creating a BIOS password.....	49
5.4.2	Changing the Serial Interface Mode (RS-232, RS-485, RS-422)	50
5.4.3	Boot Configuration	52
5.4.4	Resetting the BIOS to Factory Settings	56
6	Appendix.....	57
6.1	Accessories	57

1 History of the Manual

The following editions of the manual have been released:

Version	Comments
04/2021	First edition
09/2021	Addition Jumper settings of the DMU3200-* for 15" display usage Addition Information regarding the usage of the Ex-i ports
10/2021	Minor corrections
06/2022	Addition UL certification Addition ACP Thin Manager ready BIOS
07/2022	Minor marking corrections
06/2023	Addition VisuNet RM Shell 6 Minor corrections

2 Introduction

2.1 Content of this Document

This document contains information that you need in order to use your product throughout the applicable stages of the product life cycle. These can include the following:

- Product identification
- Delivery, transport, and storage
- Mounting and installation
- Commissioning and operation
- Maintenance and repair
- Troubleshooting
- Dismounting
- Disposal



Note

This document does not substitute the instruction manual.



Note

For full information on the product, refer to the instruction manual and further documentation on the Internet at www.pepperl-fuchs.com.

The documentation consists of the following parts:

- Present document
- Instruction manual
- Datasheet

Additionally, the following parts may belong to the documentation, if applicable:

- Type examination certificate
- EU declaration of conformity
- Attestation of conformity
- Certificates
- Control drawings
- Additional documents

2.2 Manufacturer

Pepperl+Fuchs Group Lilienthalstraße 200, 68307 Mannheim, Germany
--

Internet: www.pepperl-fuchs.com
--

2.3 Target Group, Personnel

Responsibility for planning, assembly, commissioning, operation, maintenance, and dismantling lies with the plant operator.

Only appropriately trained and qualified personnel may carry out mounting, installation, commissioning, operation, maintenance, and dismantling of the product. The personnel must have read and understood the instruction manual and the further documentation.

Prior to using the product make yourself familiar with it. Read the document carefully.

2.4 Symbols Used

This document contains symbols for the identification of warning messages and of informative messages.

Warning Messages

You will find warning messages, whenever dangers may arise from your actions. It is mandatory that you observe these warning messages for your personal safety and in order to avoid property damage.

Depending on the risk level, the warning messages are displayed in descending order as follows:



Danger!

This symbol indicates an imminent danger.

Non-observance will result in personal injury or death.



Warning!

This symbol indicates a possible fault or danger.

Non-observance may cause personal injury or serious property damage.



Caution!

This symbol indicates a possible fault.

Non-observance could interrupt the device and any connected systems and plants, or result in their complete failure.

Informative Symbols



Note

This symbol brings important information to your attention.



Action

1. This symbol indicates a paragraph with instructions. You are prompted to perform an action or a sequence of actions.

3 Product Description

The Box PC 3200-* series is an industrial stand-alone personal computer that comes in a compact, fanless design. The Box PC is based on the 7th Generation Intel® Celeron and i5 (Kaby Lake) embedded processor generation offering a great performance to cost ratio. It supports latest high-speed storage technology (M.2 NVMe 1.3) and extended RAM configurations with up to 64 GB DDR4.

The device offers a great application flexibility and can be used as a stand-alone device, as a computing unit for a Panel PC application (when mounted on a Pepperl+Fuchs Display Unit DPU3200-*) or as a computing unit in an HMI System. Box PC 3200-* provides excellent reliability for industrial environments.



Figure 3.1 The BPC3200-* can be installed with a VisuNet FLX Display Unit (DPU) as VisuNet FLX Panel installation or with an extra housing as VisuNet FLX system.

3.1 Product Highlights

- 7th Generation Intel Celeron and i5 embedded processor generation
- High data transfer rates with high-performance M.2 NVMe storage
- Wide operating temperature range -20 ... +55 °C
- Robust, fanless industrial design
- Installation flexibility: stand-alone PC, panel PC, system with enclosure
- Integrated intrinsically safe USB ports for keyboard connections

3.2 Application

The BPC3200-* is a rugged, industrial strength box personal computer optimized for 24/7 operation and intended for use in potentially explosive atmospheres, such as Zone 2 (ATEX/IECEX) or Class I, DIV 2 (cULus) [certificates in preparation]. The BPC3200-* has been specially designed for immunity to shock, vibration, and extended temperature range of up to -20°C to +55°C and is characterized by a fanless construction and industrial strength components. The BPC3200-* can be used for stand-alone applications or as a spare part within Pepperl+Fuchs VisuNet FLX product family.

Stand-alone application:



Figure 3.2



For manufacturers in the field of machine, plant and control cabinet engineering the device offers an industrial PC system for high-performance and space-saving applications:

- Process and visualization applications
- Industrial image processing
- Quality assurance and monitoring tasks
- Measurement, control and rule-based tasks
- Data acquisition and management

Usage in Combination With VisuNet FLX

The VisuNet FLX family can be installed as panel or as system integrated in a stainless steel enclosure.

VisuNet FLX Family

VisuNet FLX System	VisuNet FLX Panel	VisuNet FLX BPC3200-*
		
<p>RM-320S-*</p> <p>PC-320S-*</p> <p>DM-320S-*</p>	<p>RM-320P-*</p> <p>PC-320P-*</p> <p>DM-320P-*</p>	<p>BPC3200-*</p>

3.3 Operating Systems

The following Microsoft®-licensed operating systems are available:

- Microsoft® Windows® 10 IoT Enterprise 2021 LTSC (x64)
- VisuNet RM Shell 6.x (based on Microsoft® Windows® 10 IoT Enterprise 2021 LTSC (x64)) [Celeron, 4-GB RAM, 64-GB storage]

3.4 Firmware

VisuNet RM Shell

The VisuNet RM Shell 6 firmware allows the user to easily access applications running on a host system via Ethernet (e.g., workplace PC or server). VisuNet RM Shell 6 is based on Windows® 10 IoT Enterprise LTSC 2021, an embedded version of Windows® with long-term support that is compatible with the latest versions of popular remote protocols such as RDP 10 and VNC. Using these protocols, the BPC3200 with thin client configuration BPC3200-NB-NNNN-D-2NLP1NN-NN0 and other VisuNet Remote Monitors can be easily integrated into all major process control systems, whether they are virtual or they depend on conventional, workstation-based setups.



Note

Visit www.pepperl-fuchs.com regularly to check for the latest version of VisuNet RM Shell.



Note

Get in touch with your local technical support if you need an official Pepperl+Fuchs factory image. You can also capture your individual backup image and store this locally within your network.

ACP ThinManager Ready

As an alternative to the VisuNet RM Shell 6, the BPC3200-* can also be ordered as ACP ThinManager "Ready" BIOS installed option. Only the following configuration is possible: BPC3200-NA-NNNN-D-1NANTNN-NN0 or BPC3200-NB-NNNN-D-1NKNTNN-NN0.





The device is qualified, tested and listed with the following parameters:

Make/OEM	Model	OEM Model	Video Chipset	Package Compatibility
Pepperl+Fuchs	BPC3200	BPC3200	HD Graphics 610	8.2+

Table 3.1 For further information refer to the according ACP ThinManager documentation: https://kb.thinmanager.com/index.php/Supported_Hardware#Pepperl.2BFuchs

3.5 Reference Documents

Important Instructions and Manuals for Operating the Device

	Documentation	Contents
	VisuNet FLX Panel manual	<ul style="list-style-type: none"> • Panel installation • Information regarding 21.5", 19" and 15.6" DPU • Connecting the BPC3200-* to the DPU3200-* • Panel dimensions • Cut out dimensions • Support Pixel Errors • Gloves Tested for Touch Sensitivity
	VisuNet FLX System manual	<ul style="list-style-type: none"> • System installation (mechanical, electrical) • Power connection (DC and AC) • Installing peripherals • Maintenance • Chemical Resistance (immersion test results of common cleaning agents)
	You are here: BPC3200-* manual	<ul style="list-style-type: none"> • Technical data and expanded technical data • Electrical installation • I/O connection • DIP Switch positions when exchanging
	DMU3200-* manual	<ul style="list-style-type: none"> • Product Versions • Technical data • I/O Connection • Opening the device
	RM Shell 6 manual	<ul style="list-style-type: none"> • Overview • App Management • System Settings • Factory Reset • How-Tos

3.6 Technical Data

BPC3200-*

General specifications	
Type	Industrial box PC

Hardware	
Processor	Intel® Core™ i5-7300U Intel® Celeron™ 3965U
RAM	2x SO-DIMM slots, supports up to 64 GB DDR4-2133 (one SO-DIMM slot) Configurable RAM options: Industrial temperature grade (temperature option A): A: 1x 4 GB DDR4-2133 [Celeron] B: 1x 8 GB DDR4-2133 C: 1x 16 GB DDR4-2133 Wide temperature grade (temperature option B): K: 1x 4 GB DDR4-2133 [Celeron] L: 1x 8 GB DDR4-2133 M: 1x 16 GB DDR4-2133
Mass storage	Storage interface: 1x M.2 2242/2280 M Key, PCIe + SATA 3 1x M.2 2242/2280 M Key, 2242/2280, SATA 3, supports Raid 0/1 [i5] Configurable storage options: Industrial temperature grade (temperature option A): A: 64-GB M.2 SATA 3 [Celeron] D: 256-GB M.2 NVMe 1.3 (PCIe 4x) E: 512-GB M.2 NVMe 1.3 (PCIe 4x) Wide temperature grade (temperature option B): K: 64-GB M.2 SATA 3, wide temperature grade [Celeron] P: 256-GB M.2 NVMe 1.3 (PCIe 4x), wide temperature grade Q: 512-GB M.2 NVMe 1.3 (PCIe 4x), wide temperature grade

Supply	
Input current	max. 3 A, max. 60 W Refer to chapter 4.4.1 Power Limitations for further information.
Power consumption	
DC	24 V d. c. (20 ... 28 V d. c.) (SELV/PELV or NEC class 2)

Interface	
Interface type	<p>Backside:</p> <ul style="list-style-type: none"> 1x power button w/ LED status indicator 1x DisplayPort 1.2 port (supports DP++) 1x mini DisplayPort 1.2 port (supports DP++) 2x USB Ex i ports prepared for Pepperl+Fuchs intrinsically safe keyboard 1x RS232/422/485 port (1x RJ45) 2x RJ45 ports for Gigabit Ethernet (Intel I219 / I210) 1x USB 2.0 port 1x power input w/ 3-pin terminal block <p>Left side:</p> <ul style="list-style-type: none"> 2x antenna holes 2x USB 3.1 Gen1 (5 Gbps) ports 1x 3.5-mm audio jack (Line-out) 1x RS232/422/485 port (D-SUB 9) 1x connector for external power button <p>Internal expansion options:</p> <ul style="list-style-type: none"> 1x PCIe 4x slot for low profile cards 1x full-size mini PCI Express socket / M.2 2230 E Key socket

Directive conformity (pending)	
Electromagnetic compatibility	
Directive 2014/30/EU	<ul style="list-style-type: none"> EN 61326-1:2013 (ind. Locations) EN 61000-6-4:2007+A1:2011 EN 55035:2017/A11:2020 EN 55011:2016+A1:2017
Explosion protection	
Directive 2014/34/EU	<ul style="list-style-type: none"> EN IEC 60079-0:2018 EN IEC 60079-7:2015/A1:2018 EN 60079-11:2012
RoHS	
Directive 2011/65/EU (RoHS)	<ul style="list-style-type: none"> EN IEC 63000:2018

Software	
Operating system	<p>Microsoft® Windows® 10 IoT Enterprise 2021 LTSC (x64) VisuNet RM Shell 6 (based on Microsoft® Windows® 10 IoT Enterprise 2021 LTSC (x64)) [Celeron, 4-GB RAM, 64-GB storage]</p> <p>Optional: T: ACP ThinManager Ready BIOS [Celeron, 4 GB RAM, no storage]</p>

Ambient conditions	
Operating temperature	<p>Temperature classes:</p> <ul style="list-style-type: none"> A: 0 ... 45 °C (32 ... 113 °F) B: -20 ... 55 °C (-4 ... 131 °F) [with wide temperature grade RAM/storage]
Storage temperature	-20 ... 60 °C (-4 ... 140 °F)

2023-06

Ambient conditions	
Relative humidity	max. relative humidity 93% at 40°C (non-condensing) according to EN60068-2-78
Shock resistance	Acceleration: 15 g Duration: 11 ms Shocks: 18 (3 per axis per direction)
Vibration resistance	Amplitude / acceleration: +/- 0.075 mm // 1 g Frequency range: 10 Hz - 150 Hz Sweeps: 20

Mechanical specifications	
Degree of protection	IP 20
Material	Painted sheet metal and extruded aluminum
Mass	approx. 2.5 KG
Dimensions	305 mm x 194 mm x 45 mm
Mounting	Wall mounting, DIN rail (via optional adapter)

International approvals	
UL OrdLoc UL approval E223772	
Approved for	UL61010-1 Ed.3 UL 61010-2-201 Ed2 CAN/CSA C22.2 No 61010-1-12 CAN/CSA C22.2 No 61010-2-201
UL HazLoc UL approval E492874	
Approved for	NI circuits for CL I, DIV 2, GP A-D NI circuits for CL I, ZN 2, IIC Install per drawing 116-0478 Mounting in CL I, DIV 2, GP A-D, T4 Mounting in CL I, ZN 2, IIC, T4
ATEX approval	
ATEX certificate	UL 22 ATEX 2478X
ATEX marking	II 3 G Ex ec [ic Gc] IIC T4 Gc
IECEx approval	
IECEx certificate	IECEx ULD 22.0016X
IECEx marking	Ex ec [ic Gc] IIC T4 Gc
IECEx Standards	IEC 60079-0:2017 Ed 7.0 IEC 60079-7:2017 Ed 5.1 IEC 60079-11:2011 Ed 6.0

3.7 Expanded Technical Data

Storage Capacity

Storage Capacity	User Capacity
32 GB	30533 MB
256 GB	228937 MB
512 GB	457863 MB

Storage Reliability

Read Cycles	Unlimited Read Cycles	
Flash endurance ¹	3000 P/E Cycles	
Sequential Read - Performance results are based on CrystalDiskMark 5.1.2 with file size 1000 MB) [MB/s]	64 GB	350 MB/s
	256 GB	1550 MB/s
	512 GB	1650 MB/s
Sequential Write - Sequential Read - Performance results are based on CrystalDiskMark 5.1.2 with file size 1000 MB) [MB/s]	64 GB	70 MB/s
	256 GB	1000 MB/s
	512 GB	1600 MB/s
Total Bytes Written (TBW) (Sequential: Mainly sequential write, tested by Vdbench. These are estimated values subject to update) [TB]	64 GB	170 TB
	256 GB	593 TB
	512 GB	1186 TB

1. The damage to the memory cells of flash memories depends on the number of programs and erase cycles that have taken place and on the speed at which these cycles take place.

3.8 CPU & Performance

Thermal Throttling

For the Celeron processor, CPU throttling via a thermal control circuit is used. Depending on the system load and environmental operating temperature, the performance of the CPU may be throttled.



Note

Assess the system performance in context with the applications intended environmental conditions, including operating temperature range.

3.9 Preferred Types

Configuration	Type code	Description
High-performance configuration	BPC3200-NB-NNNN-D-2NLP1NN-NN0	Intel i5-7300U 8 GB DDR4, wide temperature (-40 ... 85°C) 256-GB M.2 NVMe, wide temperature (-40 ... 85°C) Windows® 10 IoT Enterprise LTSC 2021
Thin Client configuration	BPC3200-NA-NNNN-D-1NAA2NN-NN0	Intel Celeron 3965U 4 GB DDR4, industrial grade (0 ... 85°C) 64-GB M.2 SATA 3, industrial grade (0 ... 70°C) VisuNet RM Shell 6.x (based on Windows® 10 IoT Enterprise LTSC 2021)

3.10 Dimensions and Nameplates

Dimensions

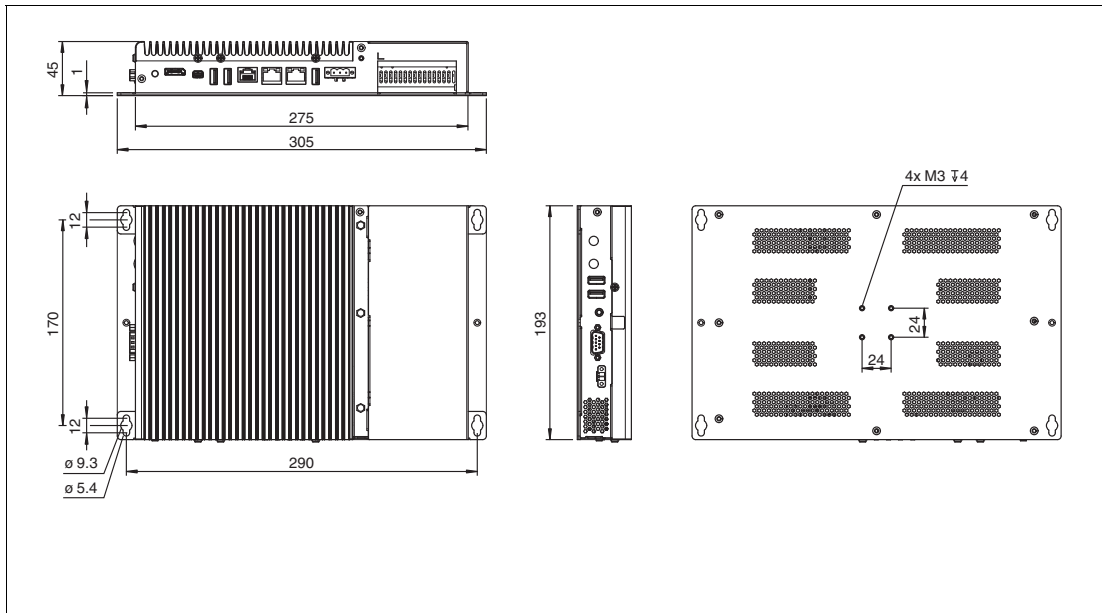

Figure 3.3 BPC3200-* dimensions

Nameplates and Labels

The following nameplates and labels are attached to the BPC3200-*:

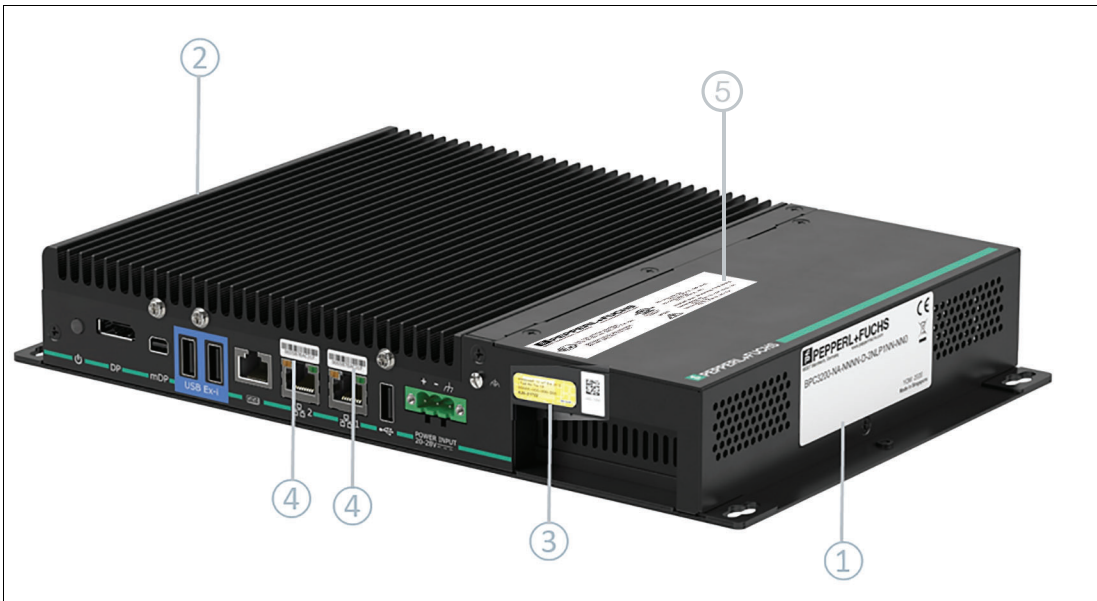

Figure 3.4 Overview of the attached labels and nameplates

(1) VisuNet FLX nameplate sample

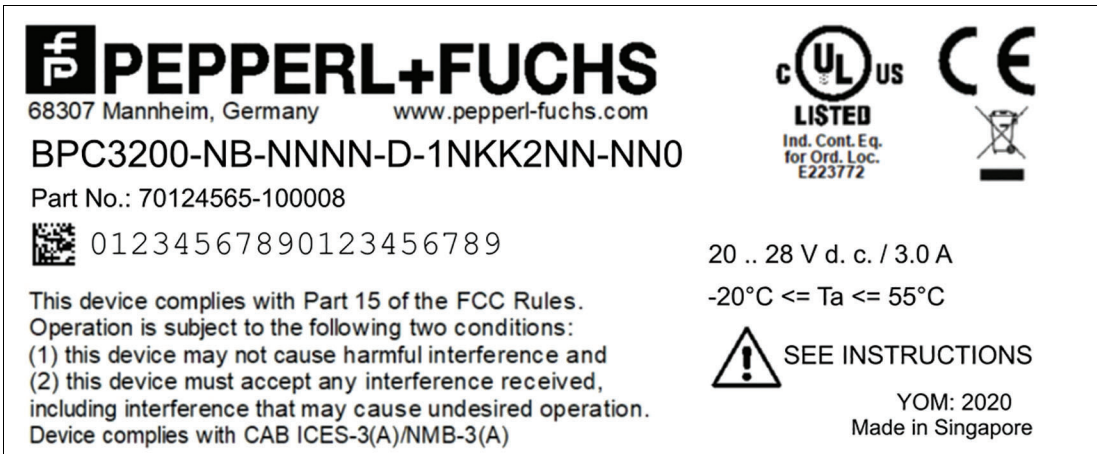

Figure 3.5

(2) Warning label - hot surface

Operating personnel must consult this manual, all warnings as applicable must be taken into consideration.



Figure 3.6

(3) Certificate of Authenticity (COA) Label

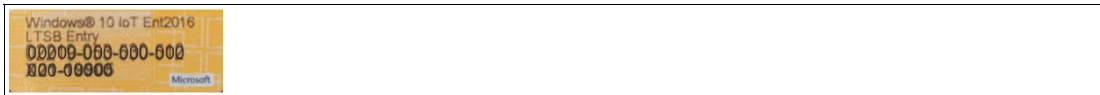

Figure 3.7

The data can be found on the product marking and on the COA label. The product marking is on the side of the device. The COA label is only available with pre-installed Windows® operating systems and is affixed to the front of the device.

(4) MAC ID



Figure 3.8

Find the MAC ID on top of the ports that describes a worldwide unique hardware address of a single network adapter. The physical address is used to identify a device in computer networks.

(5) Certification Label BPC3200-*

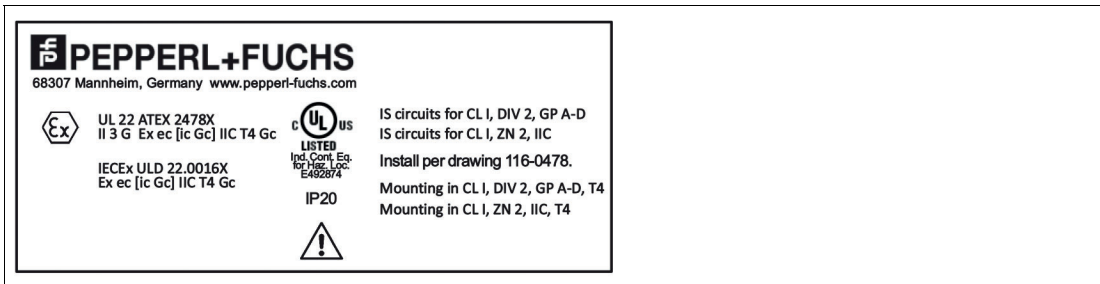

Figure 3.9

4 Installation

4.1 General Installation Requirements

- The building installation must provide a 20 A overcurrent protection.
- The installer must make a readily accessible disconnect device available.
- The safety of any system incorporating the power supply unit is the responsibility of the assembler of the system.

4.2 Mounting



Warning!

Installation!

Prior to using the product make yourself familiar with it. Read the instruction manual carefully. Observe laws, standards, and directives applicable to the intended use and the operating location. Observe Directive 1999/92/EC in relation to hazardous areas.

Preparation for Installation

Check the package contents and all accessories ordered for completeness and signs of damage. If the contents are incomplete, damaged, or do not match your order, contact your delivery Service immediately.

Included with Delivery

Device and hardware for the device:

- 1x BPC3200-*
- Bottom Plate Kit (+6 screws)
(If BPC3200-* is used as a replacement part, the bottom plate has to be removed.)

Operating System:

Depending on the configuration of your device, the device is equipped with the installed VisuNet RM Shell 6 firmware.



Note

The device is intended for indoor use. If placed in a suitable housing, the device can also be used outdoors. The specified operating temperature must be maintained in any case.



Note

If the device is used in a manner not prescribed by the manufacturer, the built-in protective function of the device may be impaired.

4.2.1 Mounting Positions

The device is cooled passively. Natural airflow is required to ensure proper cooling. If the device is installed in a housing, power dissipation from the device must be taken into account. To provide optimal cooling passing through the cooling fins, only vertical installation as shown in the graphic is recommended.

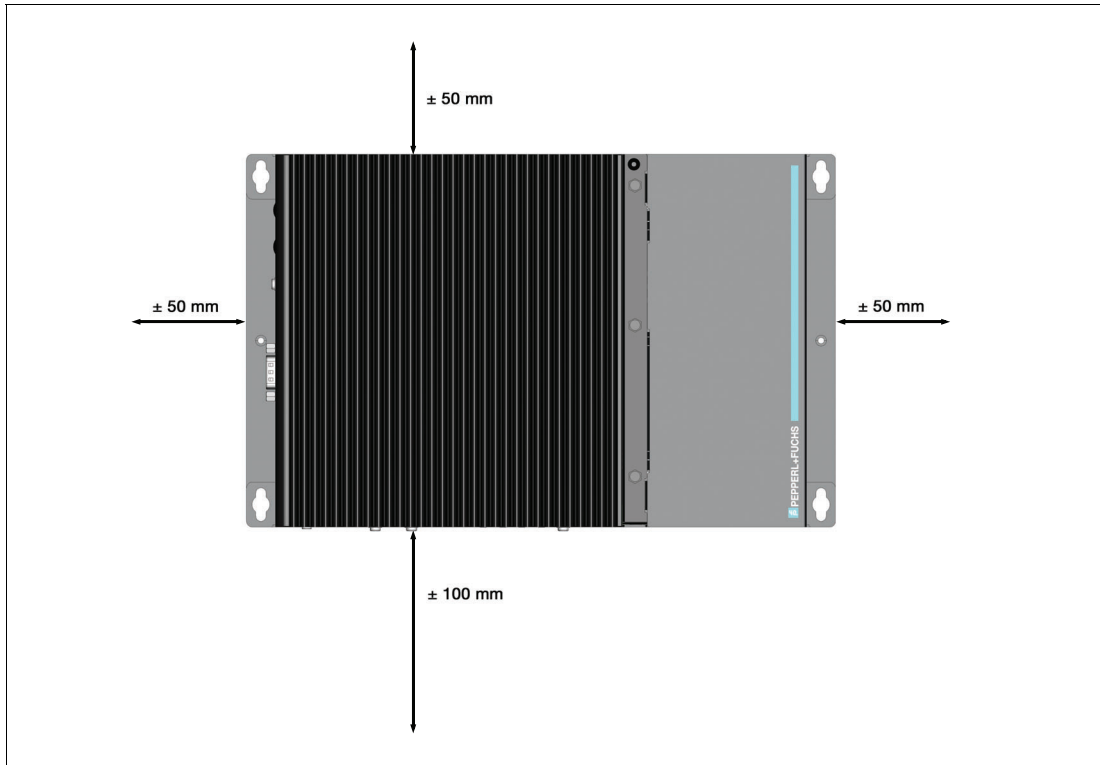

Figure 4.1

Observe the following recommended distances to other electrical components or to a housing wall:

- Below the device (if mounted vertically): ± 100 mm
- Behind the device (wall distance): 15 mm
- All other sides: ± 50 mm.



Danger!

Ambient conditions!

Do not operate the device outside the specified ambient temperature.



Warning!

Hot surface!

The surface of the device may become hot during operation.



Warning!

The device can get hot during operation!

To protect the device from excessive heating, observe the required clearances and sufficient ventilation when installing the device.



DIN Rail Mounting

Required Components:

Configured BPC3200-*

DIN rail mounting Kit #548401 (4 screws for installation included)

Required Installation Tools:

Screwdriver

1. Attach the DIN rail adapter to the back of the BPC3200-*. Use the thread on the bottom of the BPC3200-* to secure the adapter. Tighten the supplied screws to a tightening torque of 0.4 Nm.

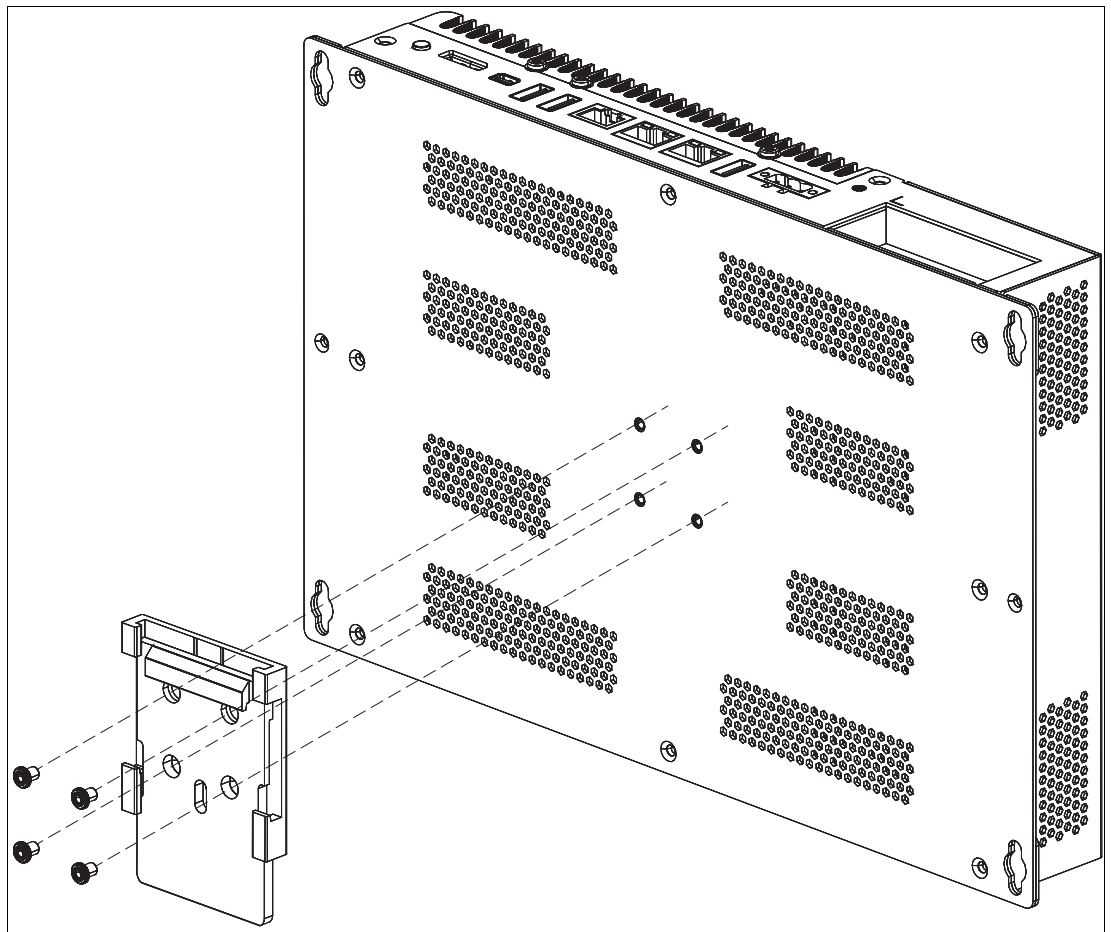

Figure 4.2

2. There is a movable clamp on the top of the DIN rail adapter. Install the BPC3200-* at a slight angle with the movable clamp over the DIN mounting rail. Apply light pressure to pull the BPC3200-* downward (1) and clamp the adapter into the rail (2).

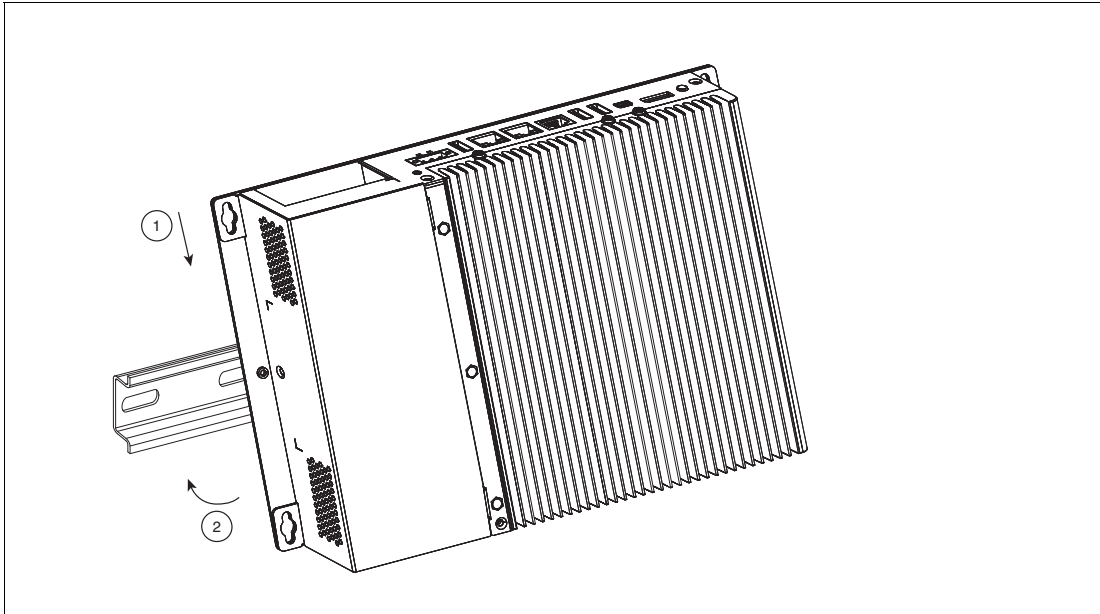

Figure 4.3

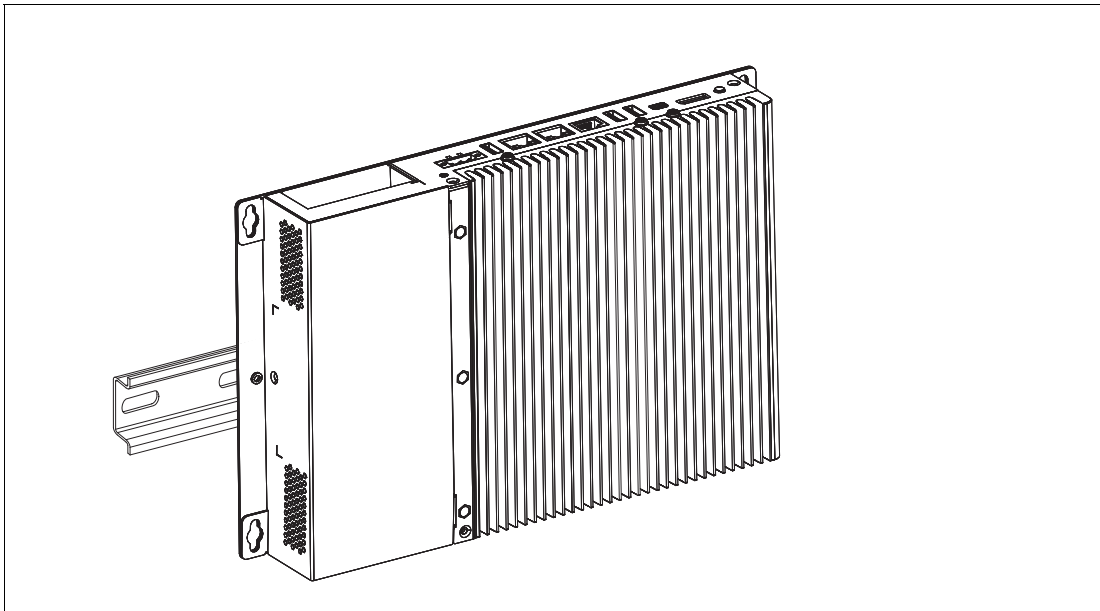

Figure 4.4



Wall Mounting

Required Components:
Configured BPC3200-*
(Screws for installation are not included)

Required Installation Tools:
Screwdriver



Caution!

Insufficient load capacity!

If the mounting surface for wall and vertical mounting does not have sufficient load capacity, the device may fall and be damaged. It is the responsibility of the installer to select a suitable location with sufficient strength for the equipment.

1. Use suitable mounting screws with a diameter of 4 mm (not included in the scope of delivery) and the following installation diagram to secure the device to the wall. Use wall anchors if necessary.

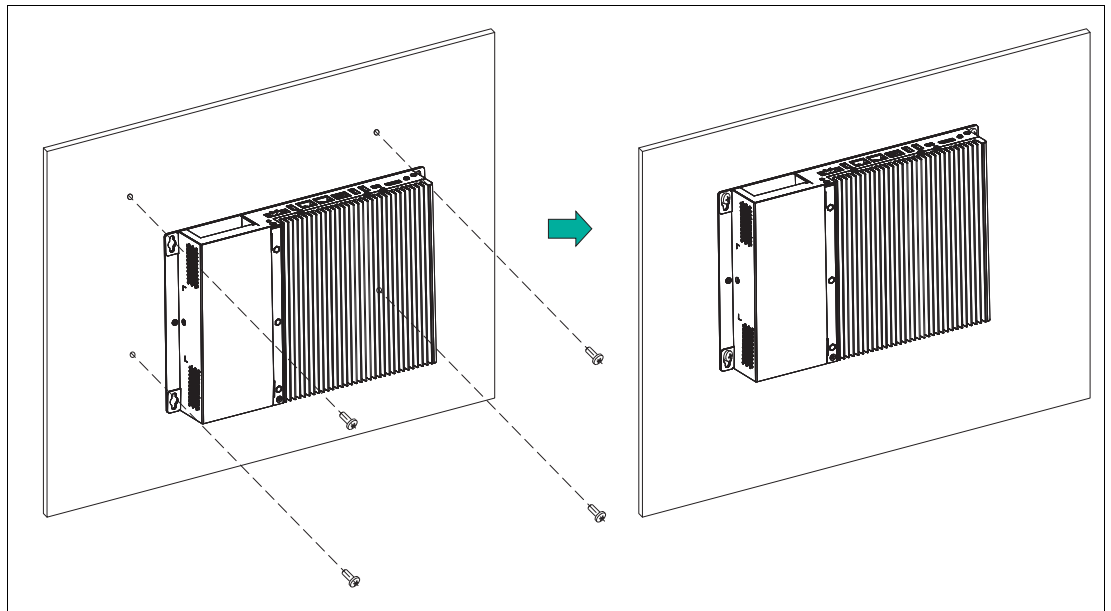

Figure 4.5

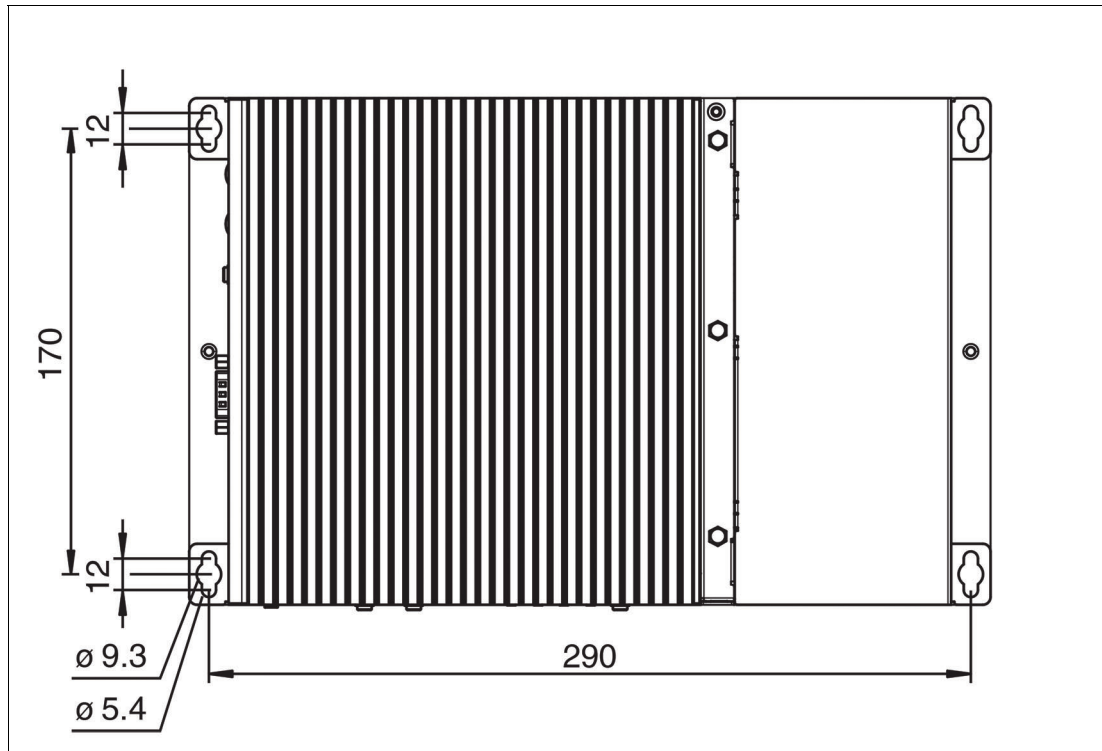

Figure 4.6

**Warning!**

Defined wall distance!

It is necessary to maintain the defined wall distance of 15 mm.

4.3**Electrical Installation****Warning!**

Explosion hazard!

Connection or disconnection of energized circuits is only permitted in the absence of a potentially explosive atmosphere. Before connecting or disconnecting circuits in the presence of a potentially explosive atmosphere, ensure that all non-intrinsically safe circuits are voltage-free and currentless.

4.4 Equipotential Bonding

System or Panel Installation

Refer to the VisuNet FLX System (RM-320S-*, PC-320S-* and DM-320S-*) and VisuNet FLX Panel Mount (RM-320P-*, PC-320P-* and DM-320P-*) manual to get detailed information on the equipotential bonding.

Stand-alone Installation

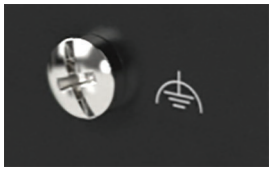

Figure 4.7

(1)	The connection for frame, chassis (ground) or shield (functional bonding) is marked with the following symbol:	
(2)	The connection for functional earthing is marked with the following symbol:	

Non-explosion Hazardous Area Installation

We recommend connecting the identified functional earthing (thread M4) of the device with the central grounding point of your shielding/grounding concept.



Caution!

Non-explosion Hazardous Area!

Functional earth shall be connected to the same potential as Protective earth or the equipotential bonding of the non-hazardous area.

Hazardous Area Installation

It is mandatory to incorporate the identified functional earthing (thread M4) in the equipotential bonding of the hazardous area.



Caution!

Hazardous Area!

Functional earth shall be connected to the equipotential bonding of the hazardous area.

4.4.1

Power Limitations



Caution!

Maximum allowed output currents!

It is necessary to consider maximum allowed output currents depending on the installation of the BPC3200-*

Available currents BPC3200-* stand-alone installation:

Port	BPC3200-*
USB 2.0	500 mA
USB Ex-i Port A	100 mA
USB Ex-i Port B	100 mA
USB 3.0 Port A	800 mA
USB 3.0 Port B	800 mA
Serial Ports (shared)	200 mA



Note

Refer to the VisuNet FLX system and VisuNet FLX Panel Mount Manual to get detailed information on the maximum output current of these installations.

The power consumption of the BPC3200-* was measured for various system configurations, workloads and power states at 28-V system input voltage.

Power Consumption BPC3200-*

	Config 1			Config 2		
CPU	Core i5			Celeron		
Memory	8 GB DDR4, wide temperature grade			4 GB DDR4, industrial temperature grade		
Storage	256-GB M.2 NVMe, wide temperature grade			64-GB M.2 SATA 3, industrial temperature grade		
OS	Windows® 10 IoT Enterprise x64 LTSC 2021			Windows® 10 IoT Enterprise x64 LTSC 2021		
BIOS Version	ELIT-3922-7300U-PE 0.13			ELIT-3922-3965U-PE 0.13		
	Input voltage			Input voltage		
Power consumption BPC:	20 V	24 V	28 V	20 V	24 V	28 V
Max. load (stress test)	21.95 W	22.71 W	23.55 W	19.94 W	20.70 W	21.48 W
idle	14.25 W	15.04 W	15.74 W	13.36 W	14.11 W	14.87 W

4.5 Connecting the Power Supply



Warning!

Hazard due to excessive current!

Excessive current can cause overloading of the electronics which could then result in injury or damage. Operate the device with a power supply that complies with SELV/PELV or NEC Class 2!



Caution!

Safety regulations!

Use only DC connecting cables which comply with the local safety regulations. Otherwise, there is a risk of fire and electric shock. This can result in personal injury or property damage.

- Ensure that the DC connecting cables comply with the safety regulations of the country in which the device is installed and bear the marks required in each case.
 - Connect the protective conductor in accordance with the operating instructions.
-



Note

Safety extra-low voltage (SELV)

- The conductors must withstand the short circuit current of the 24-V DC power source, so that a short circuit will not damage the cable.

- Only connect cables with a minimum cross section of 1.5 mm² (AWG16) and a maximum cross section of 4.0 mm² (AWG12).

4.6 I/O Connection

Interfaces support the connection of intrinsically safe accessories that match with the provided entity parameters, such as Pepperl+Fuchs' EXTA4 keyboard and mouse system. The USB Exe interface can be used to connect other third-party devices that comply with the installation requirements.

The external circuits intended to be connected to this device shall be galv. separated from mains supply or hazardous live voltage by reinforced or double insulation and meet the requirements of SELV/PELV circuit of UL/CSA 61010-1.



Note

Connections should be mechanically secured by e.g. ATEN-LockPros #548400 and/or the screws for each type of connection.



Warning!

For operation in hazardous areas the interfaces of the BPC3200-* must be mechanically secured.

The strain relief locking mechanism can be provided by installing the available accessory ATEN-LockPro.

Front view:

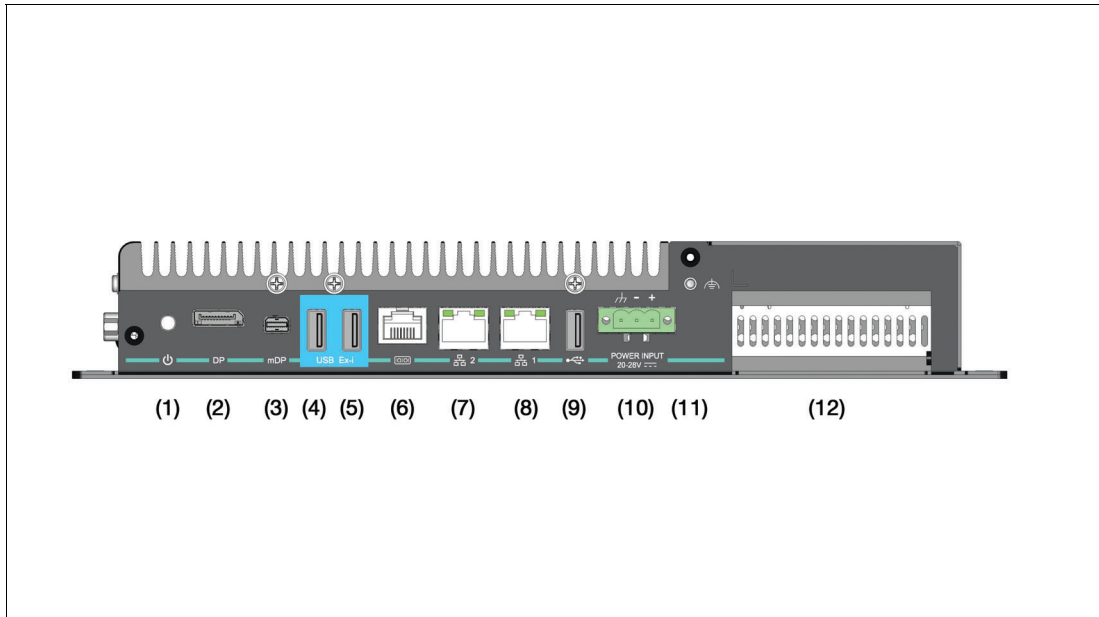

Figure 4.8

Connectors

Marker	Connector	Remarks
(1)	Power button with LED indicator	Green light when device is running
(2)	DisplayPort	Full-size DisplayPort connector
(3)	DisplayPort	Mini-DisplayPort connector
(4)	USB2 type A	USB 2.0 Ex-i port
(5)	USB2 type A	USB 2.0 Ex-i port
(6)	RJ45	RS-232/RS-485
(7)	RJ45	Ethernet
(8)	RJ45	Ethernet
(9)	USB2 type A	USB 2.0 non Ex-i port
(10)	Power in	3-pin: 24 V, GND, EARTH, must be mechanically securable
(11)	Equipotential Bonding Stud	-
(12)	Cutout for PCIe card	Standard or low profile PCIe card slot

Note

The USB2 type A Ex-i ports (4 and 5) are dedicated for the use with the Pepperl+Fuchs EXTA4 keyboard in hazardous environments. In case of usage in a non-ex environment the ports are still power limited.

Note

In case of usage in explosive environments entity parameters apply to USB Ex-i ports.

Side view:

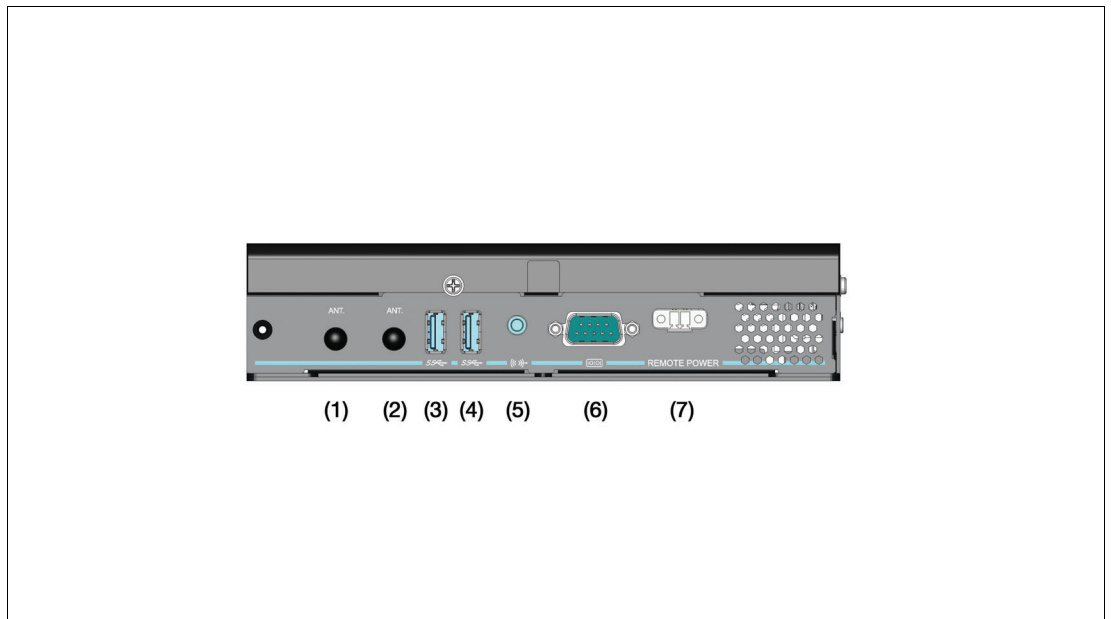

Figure 4.9

Connectors

Marker	Connector	Remarks
(1)	Antenna	SMA
(2)	Antenna	SMA
(3)	USB2 type A	USB 3.1 non Ex-i port
(4)	USB2 type A	USB 3.1 non Ex-i port
(5)	Audio jack	3.5"
(6)	D-SUB 9	RS-232/RS-485
(7)	Ext. power button	2-pin: short to start device, must be mechanically securable

LED Indicator RJ45 Ethernet Ports (7) and (8)

Type	Description
Green LED	Off: no connection Flashing: active data On: connection
Yellow LED	Off: 10-MBit/s connection Flashing: 100-MBit/s connection On: 1 GBit/s connection

DisplayPort



Figure 4.10

Pin	Type	Description	Input/Output
1	ML_Lane0+	DP Data 0+	Output
2	GND	Ground	-
3	ML_Lane0-	DP Data 0-	Output
4	ML_Lane1+	DP Data 1+	Output
5	GND	Ground	-
6	ML_Lane1-	DP Data 1-	Output
7	ML_Lane2+	DP Data 2+	Output
8	GND	Ground	-
9	ML_Lane2-	DP Data 2-	Output
10	ML_Lane3+	DP Data 3+	Output
11	GND	Ground	-
12	ML_Lane3-	DP Data 3-	Output
13	CONFIG1 CAD	Cable-adapter detection	Input
14	CONFIG2	Ground (pull down)	-
15	AUX_CH+	Auxiliary channel+	Input/Output
16	GND	Ground	-
17	AUX_CH-	Auxiliary channel-	Input/Output
18	HPD	Hot plug detect	Input
19	GND	Ground	-
20	DP_PWR	+3.3 V (fused)	Output

Mini DisplayPort

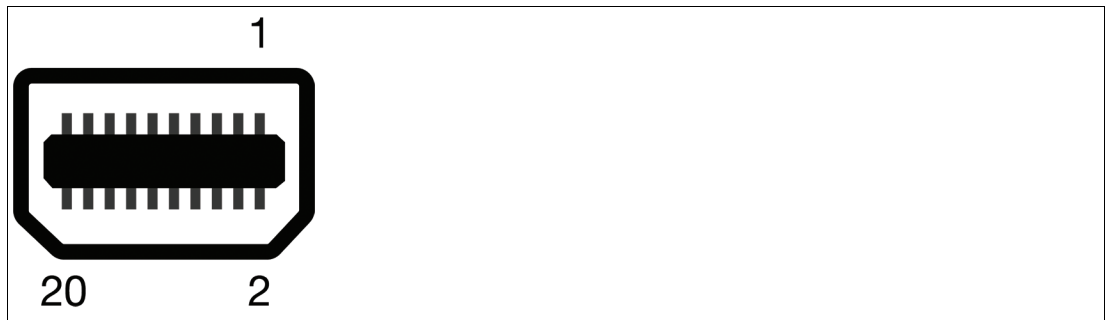

Figure 4.11 Mini DisplayPort connector pinout

Pin	Type	Description	Input/output
1	GND	Ground	-
2	HPD	Hot Plug Detect	Input
3	ML_Lane0+	DP Data 0+	Output
4	CONFIG1	Config	Config
5	ML_Lane0-	DP Data 0-	Output
6	CONFIG2	Config	Config
7	GND	Ground	-
8	GND	Ground	-
9	ML_Lane1+	DP Data 1+	Output
10	ML_Lane3+	DP Data 3+	Output
11	ML_Lane1-	DP Data 1-	Output
12	ML_Lane3-	DP Data 3-	Output
13	GND	Ground	-
14	GND	Ground	-
15	ML_Lane2+	DP Data 2+	Output
16	AUX_CH+	Auxiliary channel+	Input/Output
17	ML_Lane2-	DP Data 2-	Output
18	AUX_CH-	Auxiliary channel-	Input/Output
19	GND	Ground	-
20	DP_PWR	??	Output

The Box iPC Universal/Performance supports the installation of up to two displays.

USB ports



Figure 4.12 USB 2.0

USB 2.0

Pin	Type	Description
1	USB_P5V_-fused (A)	+5 V (fused)
2	USB_D0M (I/O)	Data-
3	USB_D0P (I/O)	Data+
4	USB_GND	GND



Figure 4.13 USB 3.0

USB 3.0

Pin	Type	Description	Input/Output
1	VBUS	+V (fused)	Output
2	D-	Data channel USB 2.0	Input/Output
3	D+	Data channel USB 2.0	Input/Output
4	GND	Ground	-
5	RX-	Data channel USB 3.0	Input
6	RX+	Data channel USB 3.0	Input
7	GND	Ground	-
8	TX-	Data channel USB 3.0	Output
9	TX+	Data channel USB 3.0	Output

RJ45 Serial Connector BIOS selectable for RS-232/422/485



RJ45 Serial Connector

Pin	RS-232	RS-485	RS-422
1	DSR/5V/12V	DSR/5V/12V	DSR/5V/12V
2	DCD	Data-	T-
3	DTR		R-
4	GND	GND	GND
5	RXD	Data+	T+
6	TXD		R+
7	CTS		
8	RTS		

The maximum transfer rate of 115 kbit/s depends on the cable length and the type of cable being used.



Note

Adjust the serial port configuration by setting the Jumper and adjust BIOS settings.

The BPC3200-* has no switch for setting the RS-232 or RS-422/485 mode. This setting must be made in the BIOS and by setting the jumpers. You can select RS-232, RS-422 or RS-485.

For further information refer to Chapter **Serial Port Configuration** and **Changing the Serial Interface Mode** (RS-232, RS-485, RS-422).

Ethernet Port

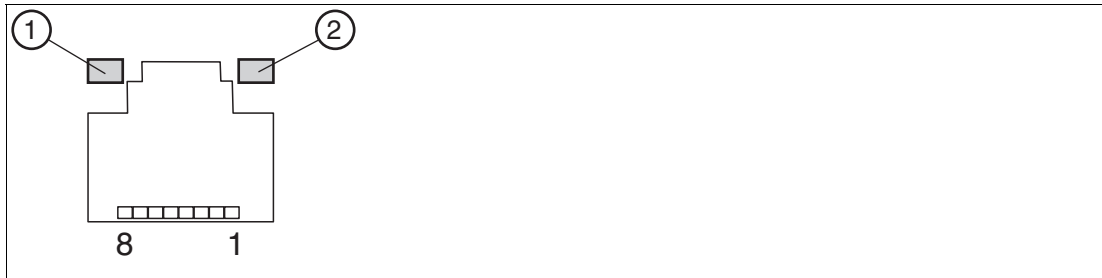

Figure 4.14

Pin	Type	Description
1	BI_DA+	Bidirectional data A+, input/output
2	BI_DA-	Bidirectional data A-, input/output
3	BI_DB+	Bidirectional data B+, input/output
4	BI_DC+	Bidirectional data C+, input/output
5	BI_DC+-	Bidirectional data C-, input/output
6	BI_DB-	Bidirectional data B-, input/output
7	BI_DD+	Bidirectional data D+, input/output
8	BI_DD-	Bidirectional data D-, input/output

LED Indicator

No.	Type	Description
1	Orange LED	On: port is active, no data exchange Flashing: port is active, data exchange Off: port is active
2	Green LED	On: 10-Mbit/s connection Flashing: 100-Mbit/s connection Off: 1-Gbit/s connection

Power In



Figure 4.15

Pin	Type	Description
1	Functional Ground	Refer to the chapter 4.4 Equipotential Bonding for further information.
2	-	
3	+	



Warning!

Refer to the defined cable specification.

D-SUB 9 Serial Connector BIOS selectable for RS-232/422/485

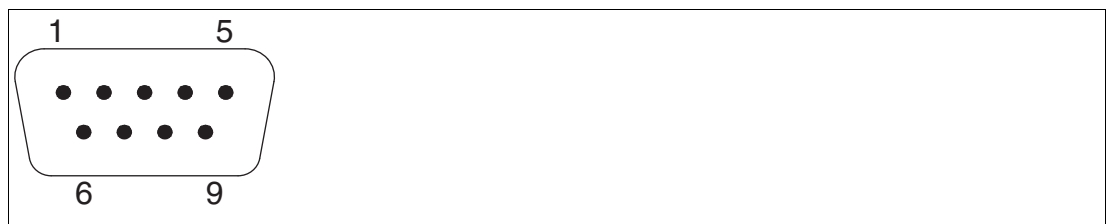

Figure 4.16

Pin	RS-232	RS-485	RS-422
1	DCD	D+	TX-
2	RXD	GND	TX+
3	TXD		RX+
4	DTR		RX-
5	GND	GND	GND
6	DSR	D-	
7	RTS		
8	CTS		
9	RI/5V/12V	RI/5V/12V	RI/5V/12V

The maximum transfer rate of 115 kbit/s depends on the cable length and the type of cable being used.



Note

Adjust the serial port configuration by setting the Jumper and adjust BIOS settings.

You can select RS-232 or RS-422/485.

The BPC3200-* has no switch for setting the RS-232 or RS-422/485 mode. This setting must be made in the BIOS and by setting the jumpers.

For further information refer to Chapter **Serial Port configuration** and **Changing the Serial Interface Mode (RS-232, RS-485, RS-422)**.

External Remote Power



Figure 4.17

Pin	Description
1	Pin to connect external Power Switch. Comparable to PIN power Button.
2	Note! This is purely a passive switch. No voltage may be applied.



Warning!

If a switch is connected, it must be mechanically secured.

4.7

Commissioning

1. Connect the BPC3200-* to the network via Ethernet port.
2. Connect the BPC3200-* to the mouse and keyboard via the USB 2.0 port.
3. Connect the BPC3200-* via one or several DisplayPorts to the corresponding display. The DisplayPort interface provides mechanical strain relief to protect against vibration. Locking mechanisms are available as accessories for additional strain relief.
4. Optional strain relief locking mechanisms can also be attached to the USB ports.
5. Connect the BPC3200-* to the DC power supply

4.8

Information on I/O Devices



Caution!

The connection of I/O devices can cause faults in the device.

The result may be personal injury and damage to the machine or plant.

- Only connect I/O devices which are approved for industrial applications in accordance with EN 61000-6-2 and IEC 61000-6-2.

- I/O devices that are not hotplug-capable may only be connected after the device has been disconnected from the power supply.

4.9 Connecting External Monitors

You find up to two ports on the front of the device for connecting monitors. These ports are connected to the motherboard. Parameter assignment is performed by means of the control panel in Windows®. The BPC 3200-* is factory set for multi-monitoring. If needed, you can configure the resolution of your monitors via VisuNet RM Shell and the adjustment via the expanded Windows® Settings. If your device is not equipped with an VisuNet RM Shell, use the general Windows® settings.



Figure 4.18

Ports for External Monitors

No.	Port
(1)	DisplayPort
(2)	Mini DisplayPort

Resolution

The maximum supported resolution of both DisplayPorts is 3840 x 2160 pixels @ 60 Hz



Note

The screen resolution might affect the system performance. The recommended screen resolution is 1920 x 1080 pixels.

5 Maintenance

5.1 Opening the device



Procedure

1. Remove the 8 screws of the bottom plate.

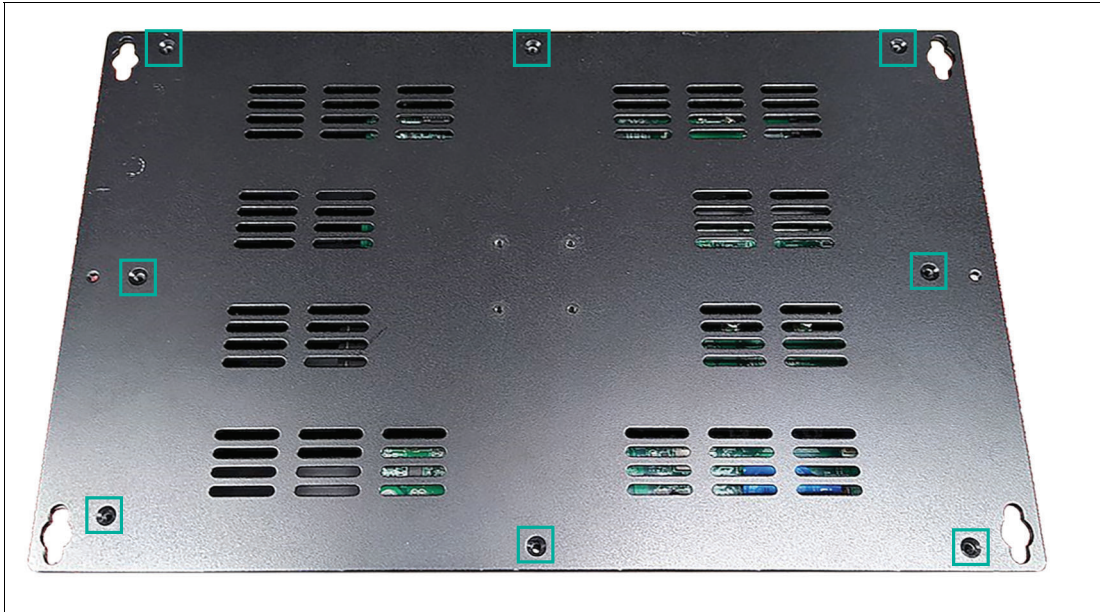

Figure 5.1

2. Remove the bottom plate.



Note

For further information regarding dismounting the BPC3200-* from a DPU refer to the VisuNet FLX Panel mount manual.

5.2 Internal Design of the Device



Warning!

Defective components!

In case of defective components the BPC3200-* must be sent back to Pepperl+Fuchs.



Figure 5.2 Opened BPC 3200-*

No.	Description
(1)	DIP switches
(2)	Jumper 1 (yellow): Change from signal to voltage supply
(3)	Jumper 2 (black): Set 5 V or 12 V



Figure 5.3 (1) DIP switches

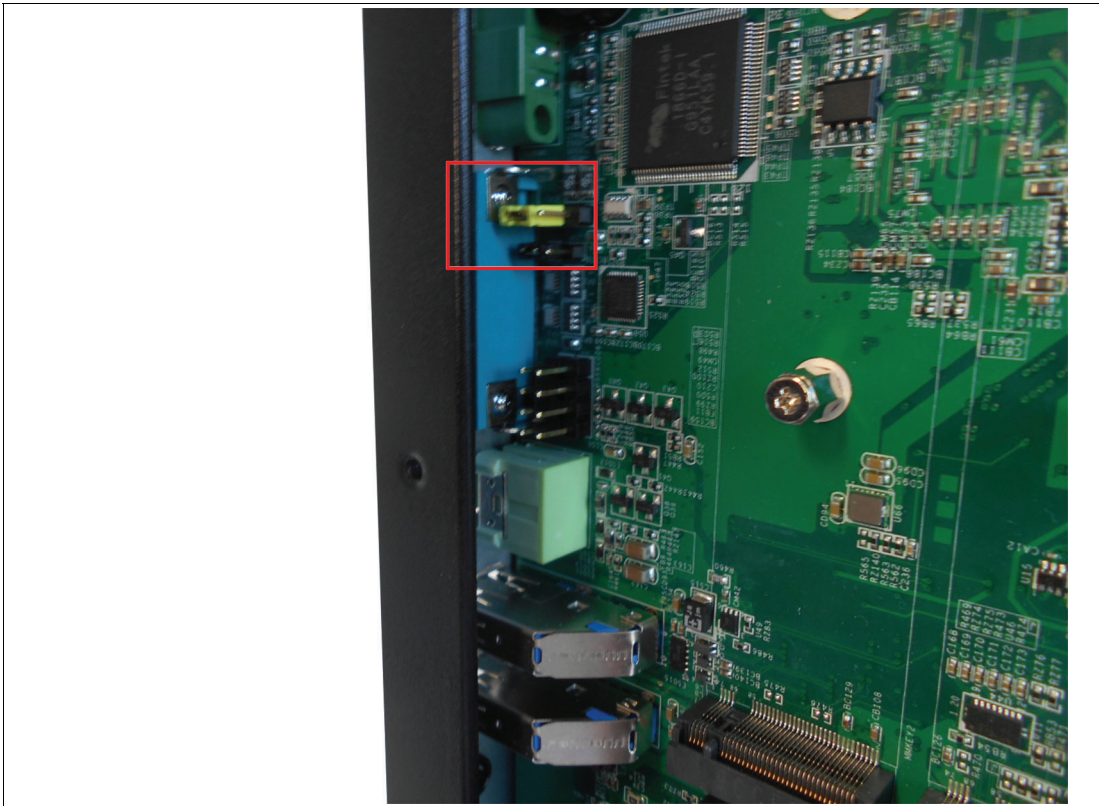

Figure 5.4 (2) Jumper 1 (yellow)



Figure 5.5 (3) Jumper 2 (black)

Serial Port configuration

Besides the correct BIOS setting (Refer to chapter **Changing the Serial Interface Mode (RS-232, RS-485, RS-422)**) the serial ports must be configured on the mainboard via the setting of the jumpers.

RJ45 Serial Port

The jumpers can be set to either 5 V/12 V supply voltage or the function for the corresponding serial protocol DSR.

Pinout

Pin	RS-232	RS-485	RS-422
1	DSR/5 V/12 V	5 V/12 V	5V/12 V
2	DCD	Data-	T-
3	DTR		R-
4	GND	GND	GND
5	RXD	Data+	T+
6	TXD		R+
7	CTS		
8	RTS		

D-SUB-9 Serial Port

The jumpers can be set to either 5 V/12 V supply voltage or the function for the corresponding serial protocol RI.

Pinout

Pin	RS-232	RS-485	RS-422
1	DCD	D+	TX-
2	RXD	GND	TX+
3	TXD		RX+
4	DTR		RX-
5	GND	GND	GND
6	DSR	D-	
7	RTS		
8	CTS		
9	RI/5 V/12 V	RI/5 V/12 V	RI/5 V/12 V

Per default the jumpers are set for the function of the RS-232 serial protocol.

Note

If you use an adapter for the D-SUB9 connector, ensure the correct pinning.



5.3 Settings when exchanging a TCU/PCU or DMU within a VisuNet FLX System or Panel

When exchanging a TCU or PCU in a VisuNet FLX system or panel, DIP switches as well as jumpers might need to be configured. Per default all DIP switches are set to "ON". This is the optimized mode for BPC3200-* stand-alone applications.

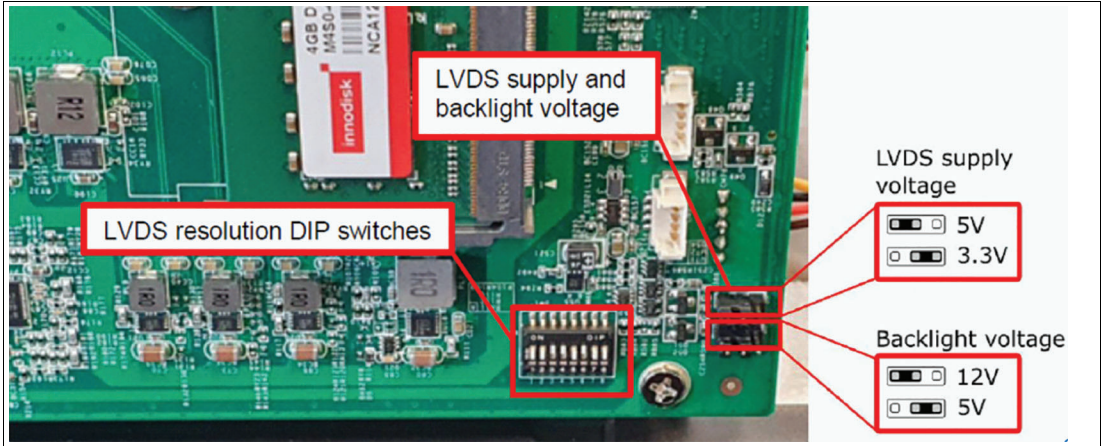

Figure 5.6

Depending on the used display unit the following DIP switch settings must be adjusted:

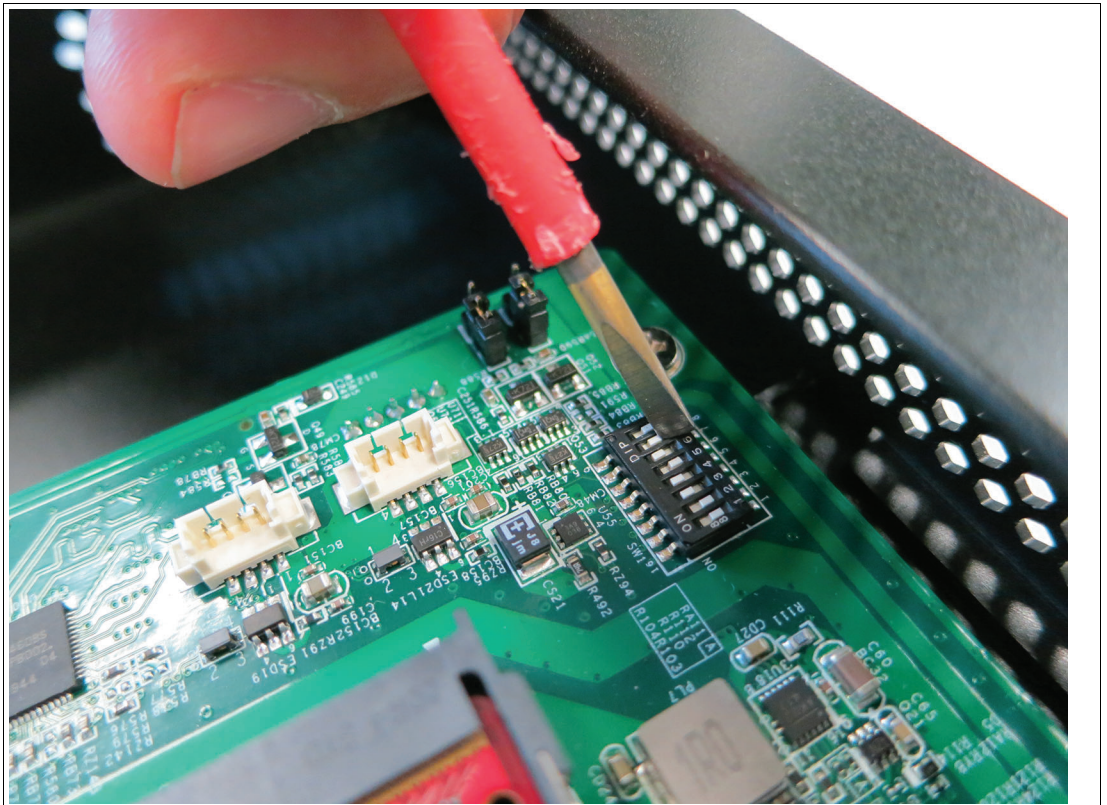

Figure 5.7

DIP Switch Positions and Jumper Settings

Part No.	Part name	Screen size	DIP switch position								Jumper	
			LVDS channel type		LVDS color format		LVDS resolution		Backlight control		LVDS signal level 3.3V or 5V (Default)	Backlight voltage 5V or 12V (Default)
			1	2	3	4	5	6	7	8		
#70126656	DPU3200-22GT-304A-V1-N0	21.5 "	o	o	x	o	o	o	x	x	5V	12V
#70126657	DPU3200-22FC-304A-V1-N0	21.5 "	o	o	o	o	x	o	x	x	5V	12V
#70126654	DPU3200-19SC-304A-V1-N0	19 "	o	o	x	o	o	x	x	x	5V	12V
#70126655	DPU3200-15FC-304A-V1-N0	15 "	o	o	o	o	x	o	x	x	3.3V	12V

Table 5.1 o: DIP switch position on, x: DIP switch position off

Jumper: Per default the Jumpers are set to 5V and 12V. This is the optimized mode for BPC3200-* stand-alone applications and the installation of the 21,5" and 19" DPUs. In case of a 15" DPU installation the Jumpers need to be adjusted as follows: Set the LVDS signal level to 3.3 V.



Warning!

If the LVDS voltage is too high and the 15" Panel is booted the display will be permanently damaged.

Make sure to set the LDVS voltage to 3.3V in advance.

5.4 BIOS Settings



Caution!

Warranty!

Any access to the BIOS is at your own risk and is not covered by the warranty for repairs. Arbitrary changes to BIOS settings may affect device functionality. The BIOS is set according to customer requirements by default.



Note

All BIOS settings are optimized for standard applications (use cases of BPC3200-*). The BIOS is protected by the default password: **pepperl**. You must enter the password each time you enter the BIOS. To prevent unauthorized access and changes to the BIOS, we advise you to set your own strong administrator password once you have installed the device.



Getting Started

1. Switch on the device.
2. During power-on, press DELETE on the keyboard.
3. Enter "pepperl" for the password.
4. Press ENTER.

Navigation

Shortcut	Function	Description
Left/right artr keys	Select screen	Menu bar and select a BIOS setup page, e.g., the main page
Up/down artr key and click	Select item	Select a BIOS setup element or a subpage
Enter/double-click	Select	Select an option to edit its value or access a submenu
+ -	Change option	Change the field value of a specific setup element, e.g., date, time
F1	General Help	Displays the general Help window
F2	Previous values	Loads previous values into the BIOS setup menu
F9	Optimized defaults	Loads optimized default values into the BIOS setup menu
F10	Save and exit	Saves the current configuration and exits the BIOS setup menu
ESC	Exit	The key allows the user to discard all changes and exit the BIOS setup menu. Press the key to exit the BIOS setup menu without saving any changes. The following screen appears: Press the key to discard changes and exit the menu. Or use the artr keys to select "No" and then press the key to cancel this function and return to the previous screen.

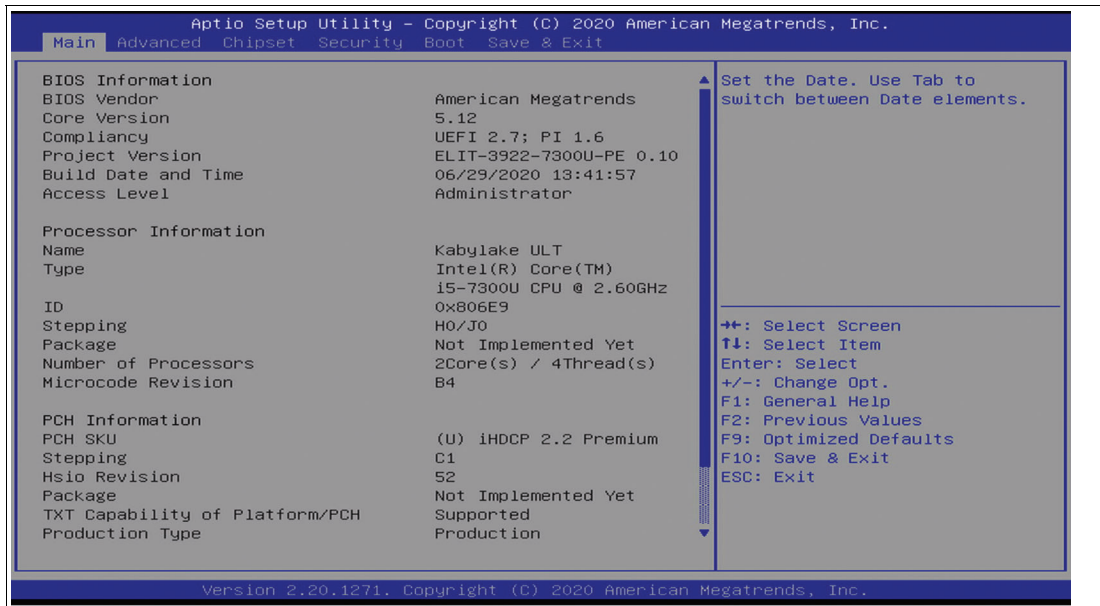

Figure 5.8 BIOS Setup Menu



Setting the System Date

1. Navigate to month, day, and year in sequence. Enter the appropriate value. Press ENTER to move to the next field.
2. Use the arrow keys to set the date.
3. Press F10 to save the changes.



Setting the System Time

1. Use the arrow buttons to set the time.
2. Navigate to hour, minute, and seconds in sequence. Enter the appropriate value. Press ENTER to move to the next field.
3. Press F10 to save the changes.

5.4.1 Creating a BIOS password

Select security from the BIOS setup page to open the "Security" BIOS setup page.

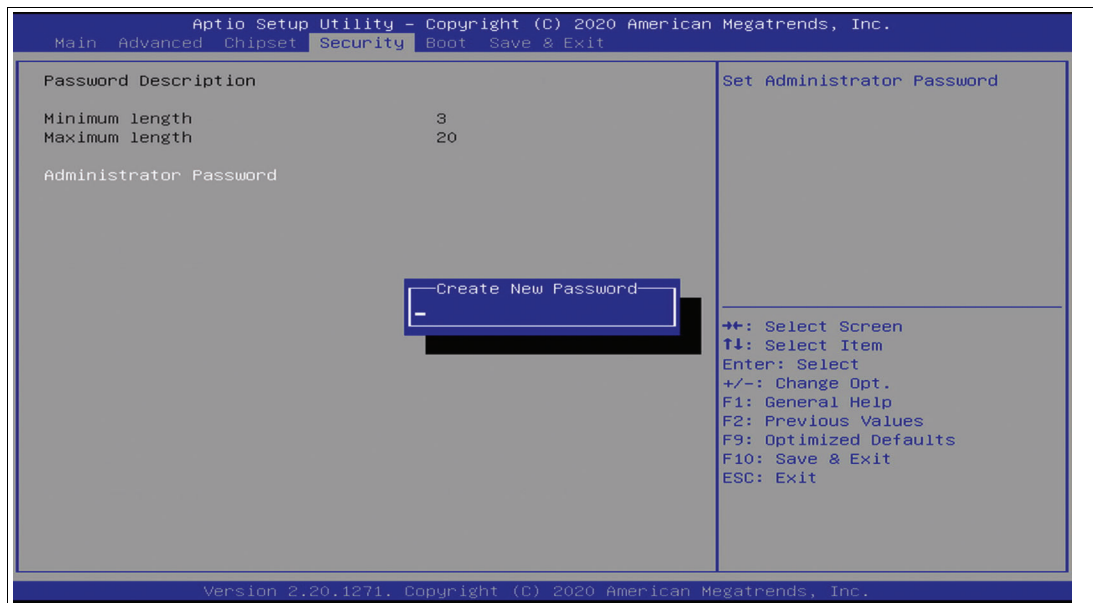

Figure 5.9



Changing the BIOS Password

The "Security" setup page allows you to set an administrator password for the BIOS.

1. Select Setup Administrator Password using the arrow keys and press Enter.
2. Enter a password of at least 3 characters. The password can be up to 20 characters long and is case-sensitive.
3. Re-enter the password when the pop-up window appears prompting you to confirm the password.



Note

After changing, note down the password and keep it in a safe place. Pepperl+Fuchs assumes no liability in case the password is lost. If you forget the password, the device must be returned to Pepperl+Fuchs for a complete reset.

5.4.2 Changing the Serial Interface Mode (RS-232, RS-485, RS-422)

Select Advanced from the BIOS setup page.



Configuring Advanced Settings

F81866 Super IO configuration allows you to view and configure the Super I/O Chip parameters.

1. Select the port you want to set using the arrow keys. Press ENTER.

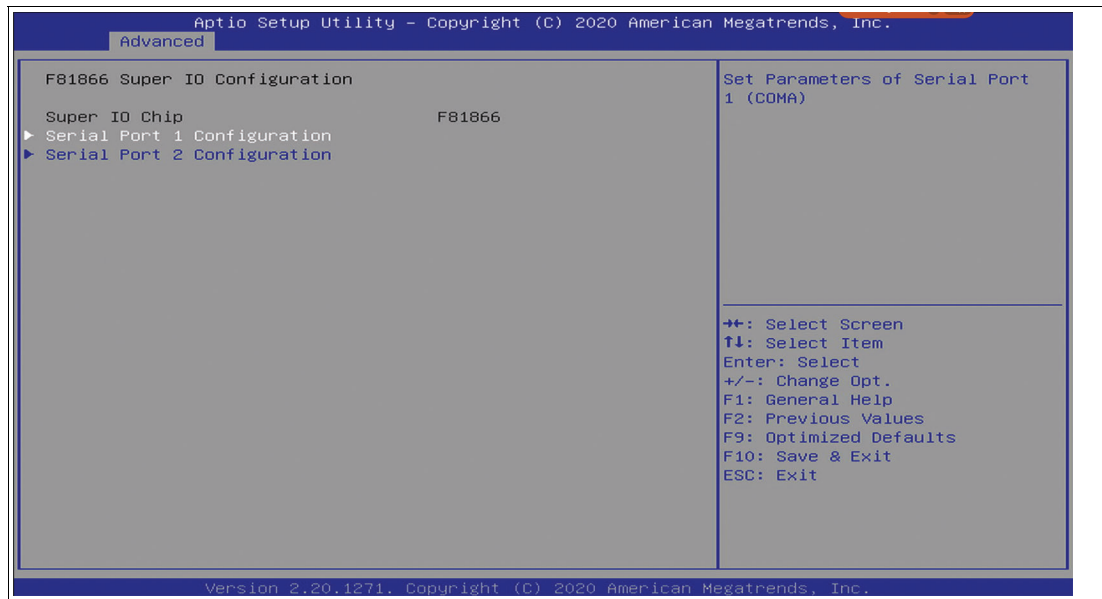

Figure 5.10



Note

Serial Port 1: DSUB9 Connector
Serial Port 2: RJ45 Connector

2. Select Enabled or Disabled. Press ENTER in the pop-up window.
3. The enabled port selects the appropriate setting change and device mode. Press ENTER.

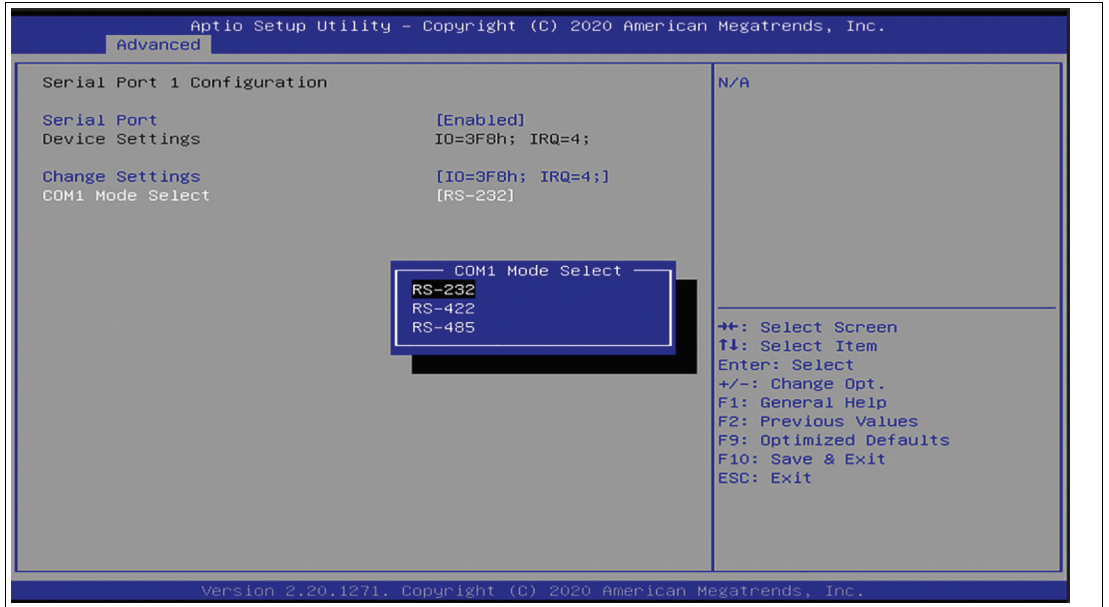

Figure 5.11

Change Settings

Settings for Serial Port 1

Device Settings	Mode Select
Auto	RS-232
IO=3F8h; IRQ=4; IO=3F8h; IRQ=3,4,5,6,7,9,10,11,12 IO=2F8h; IRQ=3,4,5,6,7,9,10,11,12 IO=3E8h; IRQ=3,4,5,6,7,9,10,11,12 IO=2E8h; IRQ=3,4,5,6,7,9,10,11,12	RS-422 RS-485

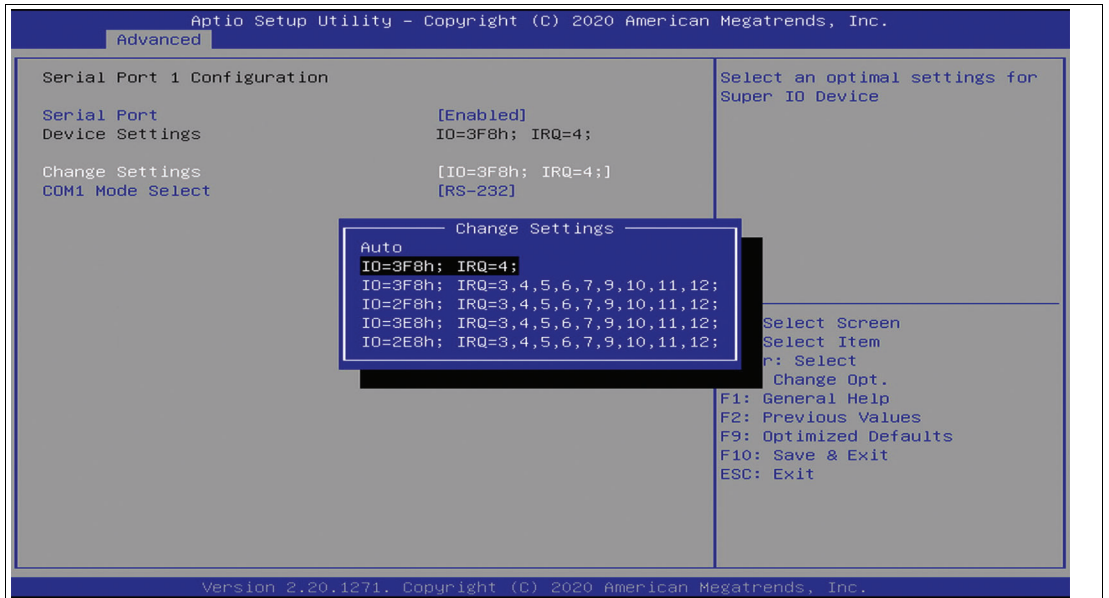

Figure 5.12

5.4.3 Boot Configuration

Select Boot from the BIOS setup page.

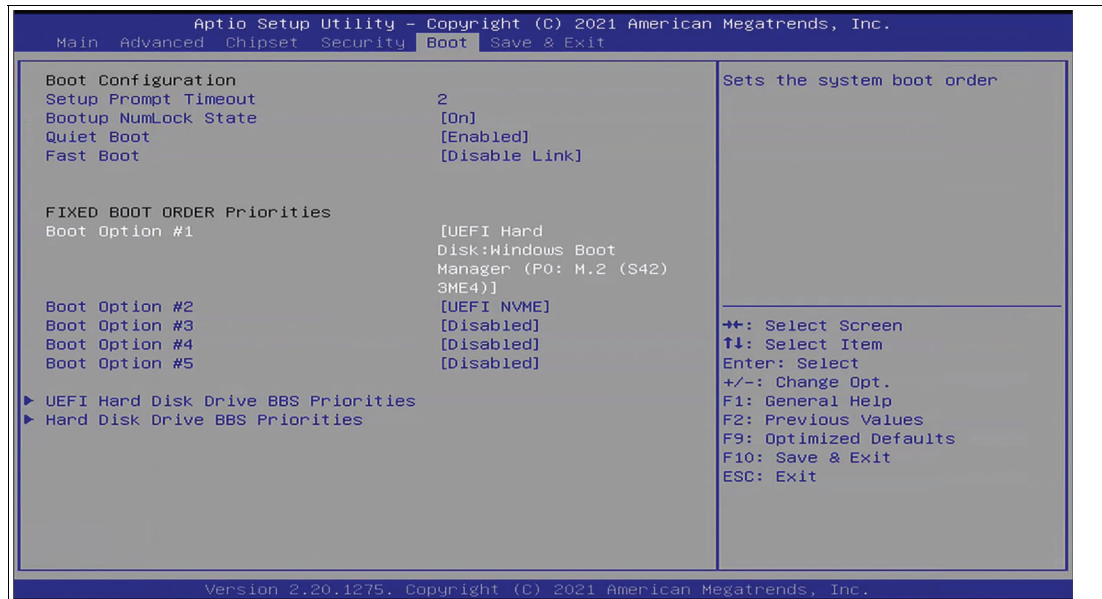

Figure 5.13

You can change the following settings on the "Boot" configuration page:

- Setup Prompt Timeout: Sets the time period within which the Delete key must be pressed to enter the BIOS at power-on.
- BootUp NumLock State: Enables and disables the numeric keys on the keyboard.

Quiet Boot: Enables and disables hiding the normal POST messages with the motherboard or system manufacturer's full-screen logo.

Fast Boot: Enables or disables boot with initialization of a minimal set of devices required to launch active boot option. Has no effect for BBS boot options.

If you want to use the PXE boot, you have to configure the following options:



Advanced - Booting from USB Stick

1. Go to USB Configuration If you want to boot with USB stick, USB Mass Storage Driver Support must be set to Enabled.



Enabling Boot via LAN (PXE)

1. Select Advanced from the BIOS setup page.

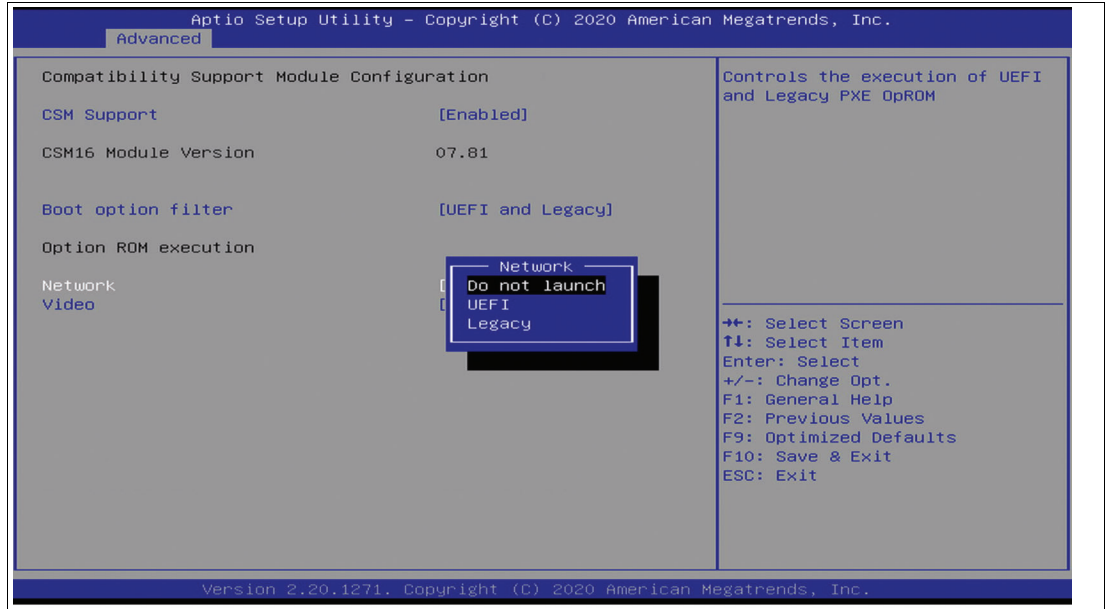

Figure 5.14

2. Select CSM Configuration with the arrow keys and press ENTER.
3. Select Network with the arrow keys. Press ENTER. Select UEFI or Legacy, depending on what your PXE server supports. Press ENTER in the pop-up window.



Setting Priorities for Boot Options

The "Boot" page allows you to set the priority of all boot devices.

1. Using the arrow keys, select the Boot Option Priority you wish to change. Press ENTER. The options window opens.

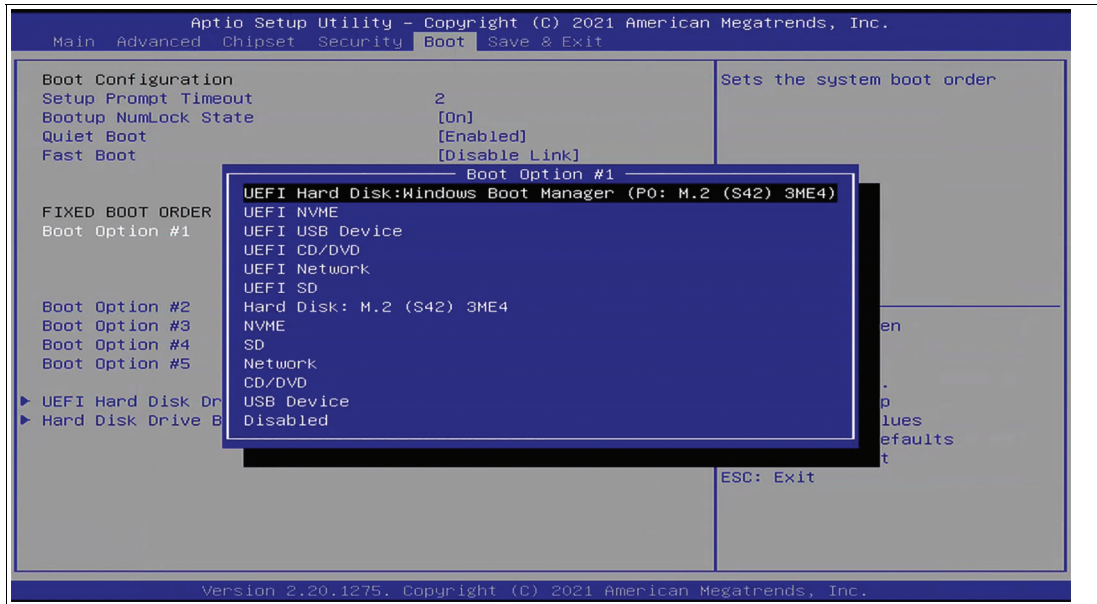

Figure 5.15



Power Management

The system starts automatically when the power supply is turned on. In the event of a power failure, the device will also automatically power up after the power supply has been restored. This default setting can be changed via Chipset settings.

1. Select Chipset from the BIOS setup page.
2. Select PCH-IO Configuration with the arrow keys and press ENTER.

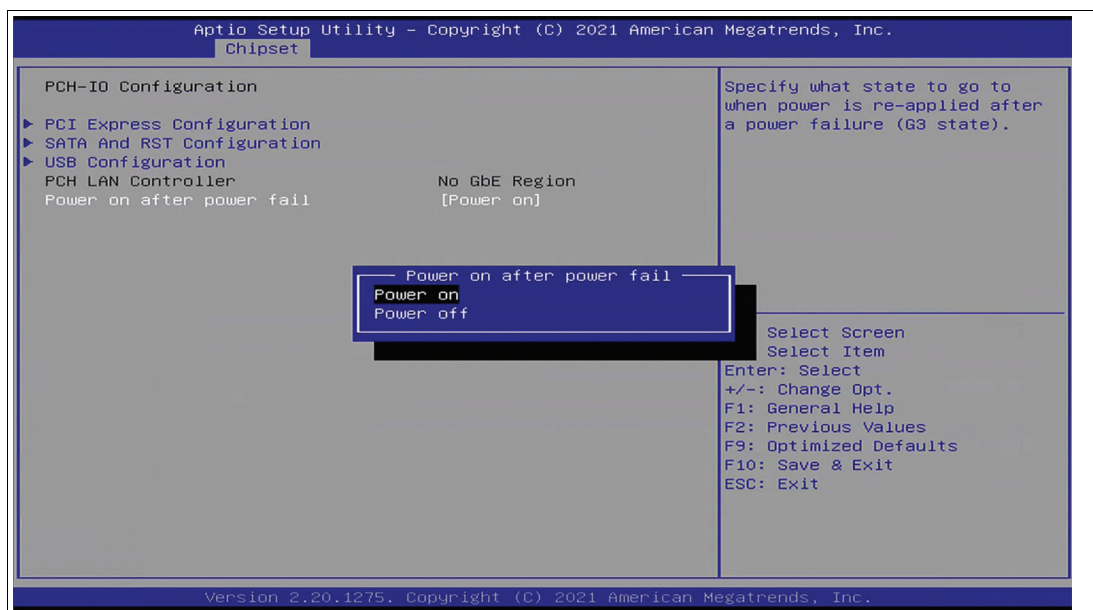

Figure 5.16

3. Select Power on after power fail and press ENTER. Specify what state to go when power is re-applied after a power failure, choose between Power off and Power on.



Save Options

1. Save Options.
2. Select "Save & Exit" from the BIOS setup page.
3. Save the changes and exit the system.
4. When you have finished making changes to the system configuration, save the changes using the following instructions.



Saving Configuration Changes

1. Select "Save Changes and Exit" using the arrow keys. Press ENTER.
2. Select "Yes". Press ENTER to save the changes and exit the system.
3. Select "No" to exit the process without saving the changes. The new system configuration settings take effect after the system is restarted.



Discarding Changes and Exiting the System

Use the following instructions to exit the system without saving the changes.

1. Using the arrow keys, select Discard Changes and "Exit." Press ENTER.
2. Select Yes. Press ENTER to discard the changes and exit the system.
3. Select No to exit the process.

5.4.4 Resetting the BIOS to Factory Settings



Restoring Default Settings

You can restore the system using the following instructions.



Figure 5.17

1. Use the arrow keys to select Restore Defaults. Press ENTER.
2. Select "Yes". Press ENTER to load the optimized default settings.
3. Select "No" to exit the process.



Restoring the Factory Settings with F9

1. Press F9:Optimized Defaults. Press ENTER.
2. Select "Yes". Press ENTER to load the optimized default settings.
3. Select "No" to exit the process.

6 Appendix

6.1 Accessories

Part-No.	Type code	Description
548400	ATEN-LockPro	Locking device for securing cables on the BTCs and BPC3200-* Each pack contains 10 locks.
548401	BTC12-KIT-DIN-RAIL	DIN rail mounting kit for BPC3200-* and BTC



Note

Accessories are available for your device that are not included in the scope of delivery. Information on accessories that can be ordered can be found online.

Your automation, our passion.

Explosion Protection

- Intrinsic Safety Barriers
- Signal Conditioners
- FieldConnex® Fieldbus
- Remote I/O Systems
- Electrical Ex Equipment
- Purge and Pressurization
- Industrial HMI
- Mobile Computing and Communications
- HART Interface Solutions
- Surge Protection
- Wireless Solutions
- Level Measurement

Industrial Sensors

- Proximity Sensors
- Photoelectric Sensors
- Industrial Vision
- Ultrasonic Sensors
- Rotary Encoders
- Positioning Systems
- Inclination and Acceleration Sensors
- Fieldbus Modules
- AS-Interface
- Identification Systems
- Displays and Signal Processing
- Connectivity

Pepperl+Fuchs Quality

Download our latest policy here:

www.pepperl-fuchs.com/quality

