

## Direct Monitor Unit

DMU3200-22GT-V1-N0

DMU3200-22FC-V1-N0

DMU3200-19SC-V1-N0

DMU3200-15FC-V1-N0

Manual



---

With regard to the supply of products, the current issue of the following document is applicable:  
The General Terms of Delivery for Products and Services of the Electrical Industry, published  
by the Central Association of the Electrical Industry (Zentralverband Elektrotechnik und Elek-  
troindustrie (ZVEI) e.V.) in its most recent version as well as the supplementary clause:  
"Expanded reservation of proprietorship"

**Worldwide**

Pepperl+Fuchs Group  
Lilienthalstr. 200  
68307 Mannheim  
Germany  
Phone: +49 621 776 - 0  
E-mail: [info@de.pepperl-fuchs.com](mailto:info@de.pepperl-fuchs.com)

**North American Headquarters**

Pepperl+Fuchs Inc.  
1600 Enterprise Parkway  
Twinsburg, Ohio 44087  
USA  
Phone: +1 330 425-3555  
E-mail: [sales@us.pepperl-fuchs.com](mailto:sales@us.pepperl-fuchs.com)

**Asia Headquarters**

Pepperl+Fuchs Pte. Ltd.  
P+F Building  
18 Ayer Rajah Crescent  
Singapore 139942  
Phone: +65 6779-9091  
E-mail: [sales@sg.pepperl-fuchs.com](mailto:sales@sg.pepperl-fuchs.com)  
<https://www.pepperl-fuchs.com>

<b>1</b>	<b>History of the Manual .....</b>	<b>4</b>
<b>2</b>	<b>Introduction.....</b>	<b>5</b>
2.1	Content of this Document.....	5
2.2	Manufacturer .....	5
2.3	Target Group, Personnel .....	5
2.4	Symbols Used .....	6
2.5	Tolerances for Linear Dimensions .....	7
<b>3</b>	<b>Product Description .....</b>	<b>8</b>
3.1	Reference Documents .....	9
3.2	Product Highlights.....	9
3.3	Application .....	10
3.4	Product Versions.....	12
3.5	Technical Data.....	12
3.6	Dimensions and Nameplates.....	14
<b>4</b>	<b>Installation.....</b>	<b>15</b>
4.1	General Installation Requirements .....	15
4.2	Mounting.....	15
4.3	Equipotential Bonding .....	16
4.4	Connecting the Power Supply .....	17
4.5	I/O Connection .....	17
4.6	Commissioning .....	23
4.7	Information on I/O Devices .....	23
<b>5</b>	<b>Maintenance.....</b>	<b>24</b>
5.1	Opening the Device .....	24

## 1 History of the Manual

The following editions of the manual have been released:

Version	Comments
03/2021	First edition

## 2 Introduction

### 2.1 Content of this Document

This document contains information that you need in order to use your product throughout the applicable stages of the product life cycle. These can include the following:

- Product identification
- Delivery, transport, and storage
- Mounting and installation
- Commissioning and operation
- Maintenance and repair
- Troubleshooting
- Dismounting
- Disposal



---

#### Note

This document does not substitute the instruction manual.

---



---

#### Note

For full information on the product, refer to the instruction manual and further documentation on the Internet at [www.pepperl-fuchs.com](http://www.pepperl-fuchs.com).

---

The documentation consists of the following parts:

- Present document
- Instruction manual
- Datasheet

Additionally, the following parts may belong to the documentation, if applicable:

- EU-type examination certificate
- EU declaration of conformity
- Attestation of conformity
- Certificates
- Control drawings
- Additional documents

### 2.2 Manufacturer

Pepperl+Fuchs Group Lilienthalstraße 200, 68307 Mannheim, Germany
--

Internet: <a href="http://www.pepperl-fuchs.com">www.pepperl-fuchs.com</a>
--

### 2.3 Target Group, Personnel

Responsibility for planning, assembly, commissioning, operation, maintenance, and dismantling lies with the plant operator.

Only appropriately trained and qualified personnel may carry out mounting, installation, commissioning, operation, maintenance, and dismantling of the product. The personnel must have read and understood the instruction manual and the further documentation.

Prior to using the product make yourself familiar with it. Read the document carefully.

## 2.4 Symbols Used

This document contains symbols for the identification of warning messages and of informative messages.

### Warning Messages

You will find warning messages, whenever dangers may arise from your actions. It is mandatory that you observe these warning messages for your personal safety and in order to avoid property damage.

Depending on the risk level, the warning messages are displayed in descending order as follows:



---

#### **Danger!**

This symbol indicates an imminent danger.

Non-observance will result in personal injury or death.

---



---

#### **Warning!**

This symbol indicates a possible fault or danger.

Non-observance may cause personal injury or serious property damage.

---



---

#### **Caution!**

This symbol indicates a possible fault.

Non-observance could interrupt the device and any connected systems and plants, or result in their complete failure.

---

### Informative Symbols



---

#### **Note**

This symbol brings important information to your attention.

---



---

#### **Action**

This symbol indicates a paragraph with instructions. You are prompted to perform an action or a sequence of actions.

## 2.5 Tolerances for Linear Dimensions

For all dimension drawings (e.g. dimension drawings, etc.) the European dimension standards are valid.

All dimensions are in mm.

Unless otherwise specified, the following general tolerances are valid.

### Nominal dimension ranges

Nominal dimension range	General tolerance according to DIN ISO 2768 medium
up to 6 mm	$\pm 0.1$ mm
over 6 mm to 30 mm	$\pm 0.2$ mm
over 30 mm to 120 mm	$\pm 0.3$ mm
over 120 mm to 400 mm	$\pm 0.5$ mm
over 400 mm to 1000 mm	$\pm 0.8$ mm

### 3 Product Description







Figure 3.1

The DMU is part of the VisuNet FLX series and can be either installed within the VisuNet FLX system or VisuNet FLX panel. Furthermore is the DMU available as replacement part.



### 3.1 Reference Documents

#### Important Instructions and Manuals for Operating the Device

	Documentation	Contents
	<b>VisuNet FLX Panel manual</b>	<ul style="list-style-type: none"> <li>• Panel installation</li> <li>• Information regarding 21,5", 19" and 15,6" DPU</li> <li>• Connecting the BPC3200-* to the DPU3200-*</li> <li>• Panel dimensions</li> <li>• Cut out dimensions</li> </ul>
	<b>VisuNet FLX System manual</b>	<ul style="list-style-type: none"> <li>• System installation (mechanical, electrical)</li> <li>• Power connection (DC and AC)</li> <li>• Installing peripherals</li> <li>• Maintenance</li> </ul>
	<b>BPC32000-* manual</b>	<ul style="list-style-type: none"> <li>• Technical data and expanded technical data</li> <li>• Electrical installation</li> <li>• I/O connection</li> <li>• DIP Switch positions when exchanging a computing unit</li> <li>• BIOS settings</li> </ul>
	<b>You are here: DMU3200-* manual</b>	<ul style="list-style-type: none"> <li>• Product Versions</li> <li>• Technical data</li> <li>• I/O Connection</li> <li>• Opening the device</li> </ul>

### 3.2 Product Highlights

- Allows direct connection of display to a PC video interface
- Offers HDMI, DVI and VGA interface for high connectivity flexibility
- Capacitive touch screen support via USB interface
- Supports up to Full HD screen resolution
- Robust, fanless industrial design with -20 ... +55 °C operating temperature range

### 3.3 Application

The Direct Monitor 3200\* - series is a component of the VisuNet FLX 3200 Direct Monitor series and represents the video interface for a connected Pepperl+Fuchs Display Unit (DPU3200-\* series). It offers modern digital video interfaces (HDMI), legacy digital (DVI) and analog video interfaces (VGA) for a broad application flexibility. Furthermore, the touch screen signals of a connected display unit can be used by the connected PC via the USB interface. The built-in OSD menu allows the adjustment and configuration of the displayed image, including scaling factors, brightness, contrast etc.

#### VisuNet FLX DM-Panel PC



Figure 3.2 Panel = Display, DMU

## VisuNet FLX DM System



Figure 3.3 System = Display, DMU and Housing

### 3.4 Product Versions

Part number	Part name	Description
70128304	DMU3200-22GT-V1-N0	Spare part Direct Monitor (DMU) <ul style="list-style-type: none"> <li>compatible with VisuNet series 320S* / 320P*</li> <li>compatible with display option "22GT" - 21.5 " display</li> </ul>
70128305	DMU3200-22FC-V1-N0	Spare part Direct Monitor (DMU) <ul style="list-style-type: none"> <li>compatible with VisuNet series 320S* / 320P*</li> <li>compatible with display option "22FC" - 21.5 " display</li> </ul>
70128306	DMU3200-19SC-V1-N0	Spare part Direct Monitor (DMU) <ul style="list-style-type: none"> <li>compatible with VisuNet series 320S* / 320P*</li> <li>compatible with display option "19SC" - 19 " display</li> </ul>
70128307	DMU3200-15FC-V1-N0	Spare part Direct Monitor (DMU) <ul style="list-style-type: none"> <li>compatible with VisuNet series 320S* / 320P*</li> <li>compatible with display option "15FC" - 15.6 " display</li> </ul>

### 3.5 Technical Data

#### DMU3200-\*

General specifications	
Type	Direct Monitor Unit

Supply	
Power consumption	
DC	24 V d. c. (20 ... 28 V d. c.) (SELV/PELV or Class 2)

Interface	
Interface type	1x power input w/ 3-pin terminal block 1x HDMI 1x DVI-I 1x VGA 1x USB 1x OSD Menu w/ power button
Communication	Communication Distance: HDMI (typ. 5 m @ Full HD) DVI-I (typ. 5 m @ Full HD) VGA (typ. 10 m @ Full HD) USB (Touch-) signal (max. 5 m) depends on quality of cable and environment (EMC)
Resolution	Maximum resolution: Full HD (1920 x 1080)

Directive conformity	
<b>Electromagnetic compatibility</b>	
Directive 2014/30/EU	DIN EN 55035:2018-04
<b>RoHS</b>	
Directive 2011/65/EU (RoHS)	EN IEC 63000:2018

Ambient conditions	
Operating temperature	-20 ... 55 °C (-4 ... 131 °F)
Storage temperature	-20 ... 60 °C (-4 ... 140 °F)
Relative humidity	max. relative humidity 93 % at 40 °C (non-condensing) according to EN60068-2-78
Shock resistance	Acceleration: 15 g Duration: 11 ms Shocks: 18 (3 per axis per direction)
Vibration resistance	Amplitude / acceleration: +/- 0.075 mm // 1 g Frequency range: 10 Hz - 150 Hz Sweeps: 20

Mechanical specifications	
Degree of protection	IP 20
Material	Painted sheet metal
Mass	1 kg
Dimensions	226 mm x 125 mm x 33 mm
Mounting	Direct mounting to Pepperl+Fuchs Display Unit (3200 series)

General information	
Supplementary information	Only available as replacement part with a Pepperl+Fuchs Display Unit of 3200 series

### 3.6 Dimensions and Nameplates

#### Dimensions

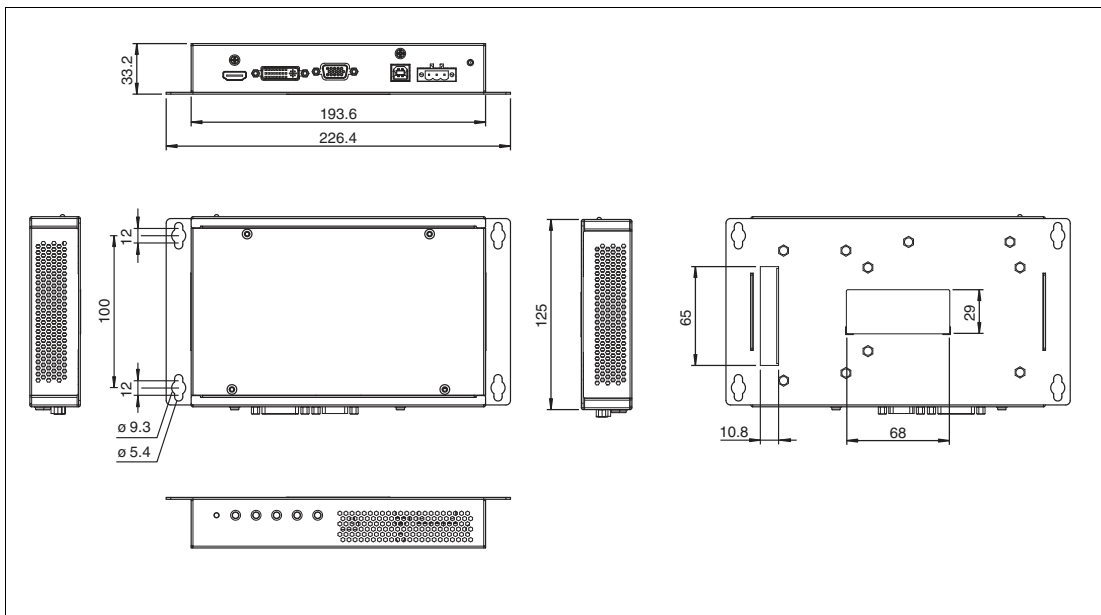

Figure 3.4 Dimensions

#### Nameplates

The following label is attached to the DMU3200-\*:



Figure 3.5 Nameplate Sample (General Purpose)

## 4 Installation

The DMU3200-\* is only available as replacement part and can only be operated installed in a VisuNet FLX Panel or VisuNet FLX System.

### 4.1 General Installation Requirements

- The building installation must provide a 20 A overcurrent protection.
- The installer must make a readily accessible disconnect device available.
- The safety of any system incorporating the power supply unit is the responsibility of the assembler of the system.

### 4.2 Mounting



---

#### Warning!

Installation

The device must be installed by competent personnel in accordance with the instructions. All applicable laws and regulations must be carefully observed.

---

#### Preparation for Installation

Check the package contents and all accessories ordered for completeness and signs of damage. If the contents are incomplete, damaged, or do not match your order, contact your delivery service immediately.

#### Included with Delivery

Device and hardware for the device:

- 1x DMU3200-\*



---

#### Note

The DMU3200-\* is only available as spare part and can only be operated with the VisuNet FLX Display Unit as system- or panel installation.

---



---

#### Note

The device is intended for indoor use. If placed in a suitable housing, the device can also be used outdoors. The specified operating temperature must be maintained in any case.

---



---

#### Note

If the device is used in a manner not prescribed by the manufacturer, the built-in protective function of the device may be impaired.

---

## 4.3 Equipotential Bonding

### System or Panel Installation

Refer to the VisuNet FLX system and VisuNet FLX Panel Mount manual to get detailed information on the equipotential bonding.

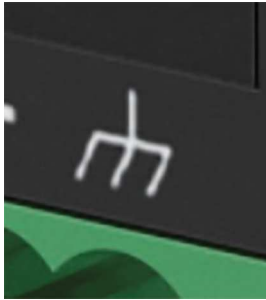
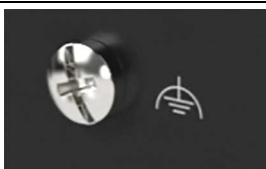

Figure 4.1

(1)	The connection for frame, chassis (ground) or shield (functional bonding) is marked with the following symbol:	
(2)	The connection for functional earthing is marked with the following symbol:	



## 4.4 Connecting the Power Supply

---



### Caution!

Safety regulations!

Use only DC connecting cables which comply with the local safety regulations. Otherwise, there is a risk of fire and electric shock. This can result in personal injury or property damage.

- Ensure that the DC connecting cables comply with the safety regulations of the country in which the device is installed and bear the marks required in each case.
  - Connect the protective conductor in accordance with the operating instructions.
- 



### Note

#### Safety extra-low voltage (SELV)

The device must only be connected to a 24 V DC power supply which meet the requirements of a safe extra low voltage (SELV) according to IEC/EN/DIN EN/UL 61010-2-201.

The conductors must withstand the short circuit current of the 24-V DC power source, so that a short circuit will not damage the cable.

Only connect cables with a minimum cross section of 1.5 mm<sup>2</sup> (AWG16) and a maximum cross section of 4.0 mm<sup>2</sup> (AWG12).

---

## 4.5 I/O Connection

---



### Warning!

For operation in hazardous areas the interfaces of the DMU3200-\* must be mechanically secured.

The strain relief locking mechanism can be provided by installing the available accessories ATEN-LockPros.

---



### Note

Connections should be mechanically secured by e.g. the ATEN-LockPros #548400 (which can be purchased from Pepperl+Fuchs) and/or the screws for each type of connection.

---

Front view:

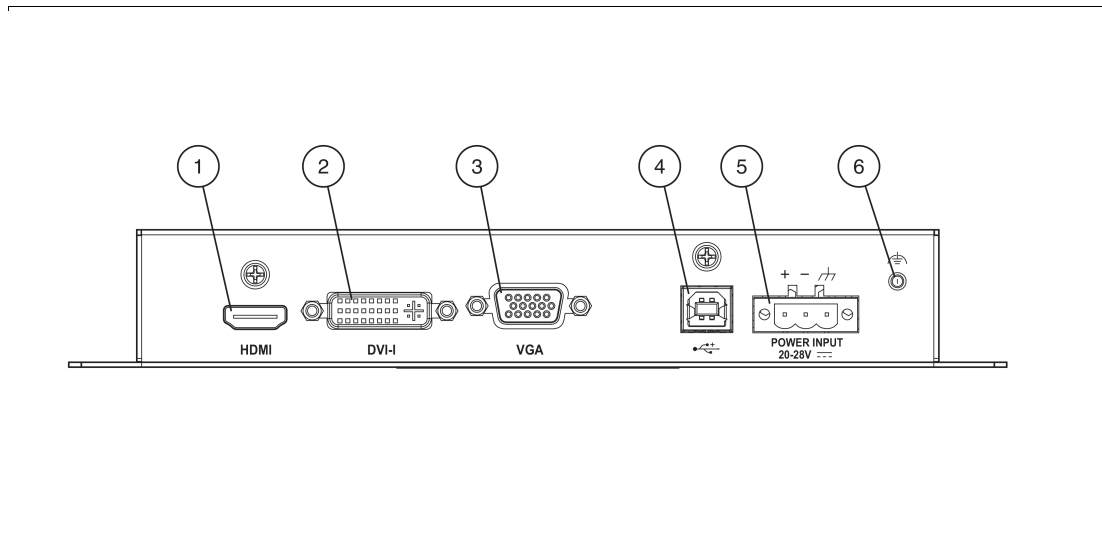

Figure 4.2

Connectors

Marker	Connector
(1)	HDMI
(2)	DVI-I
(3)	VGA
(4)	USB Type B
(5)	Power input
(6)	Functional earthing

**Back view:**

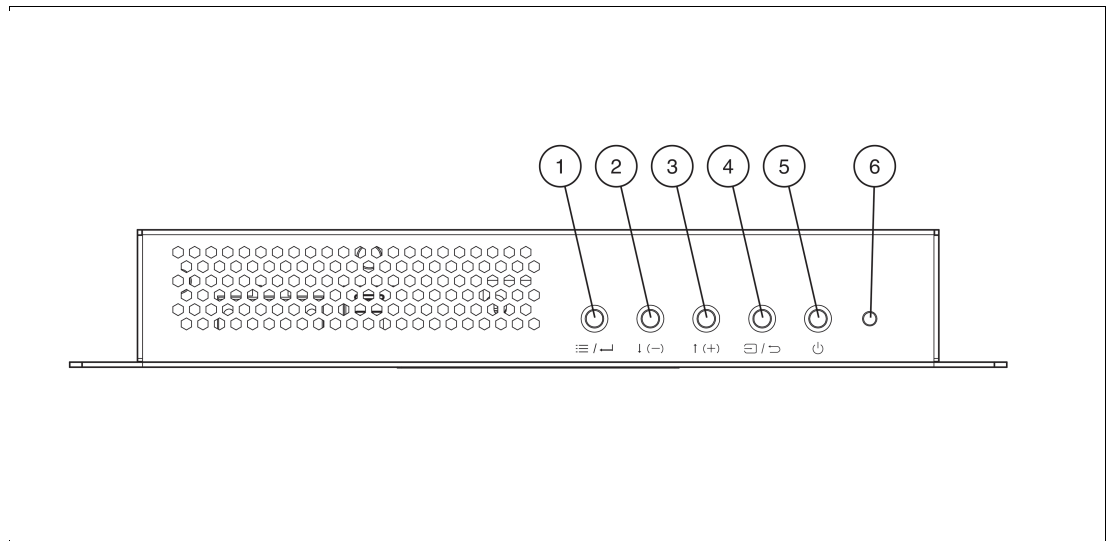

Figure 4.3

**Connectors**

Marker	Connector
(1)	Menu
(2)	Down
(3)	Up
(4)	Source
(5)	Power
(6)	

**HDMI**



Figure 4.4

Pin No.	
Pin 1	TMDS Data2+
Pin 2	TMDS Data2 Shield
Pin 3	TMDS Data2-
Pin 4	TMDS Data1+
Pin 5	TMDS Data1 Shield
Pin 6	TMDS Data1-
Pin 7	TMDS Data0+
Pin 8	TMDS Data0 Shield
Pin 9	TMDS Data0-
Pin 10	TMDS Clock+
Pin 11	TMDS Clock Shield

Pin No.	
Pin 12	TMDS Clock-
Pin 13	CEC
Pin 14	Reserved (HDMI 1.0-1.3a) Utility/HEAC+ (HDMI 1.4+, optional, HDMI Ethernet Channel and Audio Return Channel)
Pin 15	SCL (IC serial clock for DDC)
Pin 16	SDA (IC serial data for DDC)
Pin 17	Ground (for DDC, CEC, ARC and HEC)
Pin 18	+5 V (min. 0.055 A)
Pin 19	Hot Plug Detect (all versions) HEAC- (HDMI 1.4+, optional, HDMI Ethernet Channel and Audio Return Channel)

### DVI-I and VGA

The analog input is an industry-standard, 15-pin VGA connector with 3 rows of 5 pins each. The digital input is an industry standard, 29-pin DVI connector with 3 rows of 8 pins each. Supply a high-quality cable between this connector and the video port on your computer, maximum 100 feet (30 meters) for the analog input and maximum 15 feet (4.5 meters) for the digital input.



#### Caution!

The transmission is strongly dependent on the signal quality, which can depend on the video interface, cable quality, shielding and existing sources of interference.

The specified cable lengths are only guide values that must be checked in each individual case within the application.

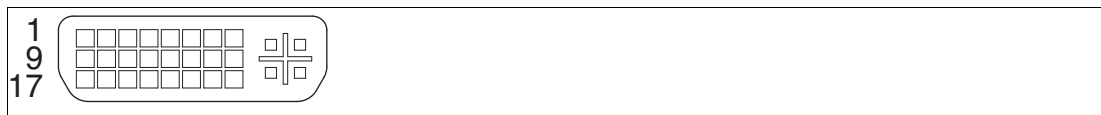

Figure 4.5

#### DVI-I

Pin No.		
Pin 1	TMDS Data2-	Digital red- (link1)
Pin 2	TMDS Data2+	Digital red+ (link1)
Pin 3	TMDS Data2/4 shield	-
Pin 4	TMDS Data4-	Digital green- (link 2)
Pin 5	TMDS Data4+	Digital green+ (link 2)
Pin 6	DDC clock	-
Pin 7	DDC data	-
Pin 8	Analog vertical sync	-
Pin 9	TMDS Data1-	Digital green- (link 1)
Pin 10	TMDS Data1+	Digital green+ (link 1)
Pin 11	TMDS Data 1/3 shield	-
Pin 12	TMDS data 3-	Digital blue- (link 2)
Pin 13	TMDS data 3+	Digital blue+ (link 2)
Pin 14	+5 V	Power for monitor when in standby
Pin 15	Ground	Return for pin 14 and analog sync

2021-03

Pin No.		
Pin 16	Hot plug detect	-
Pin 17	TMDS data 0-	Digital blue- (link 1) and digital sync
Pin 18	TMDS data 0+	Digital blue+ (link 1) and digital sync
Pin 19	TMDS data 0/5	-
Pin 20	TMDS data 5-	Digital red- (link 2)
Pin 21	TMDS data 5+	Digital red+ (link 2)
Pin 22	TMDS clock shield	-
Pin 23	TMDS clock+	Digital clock+ (links 1 and 2)
Pin 24	TMDS clock-	Digital clock- (links 1 and 2)
C1	Analog red	
C2	Analog green	
C3	Analog blue	
C4	Analog horizontal sync	
C5	Analog ground	Return for R, G and B signals



Figure 4.6

**VGA**

Pin No.		
Pin 1	RED	Red video
Pin 2	GREEN	Green video
Pin 3	BLUE	Blue video
Pin 4	ID2/RES	Reserved since E-DDC, formerly monitor id. bit 2
Pin 5	GND	Ground (HSync)
Pin 6	RED_RTN	Red return
Pin 7	GREEN_RTN	Green return
Pin 8	BLUE_RTN	Blue return
Pin 9	KEY/PWR	+5 V DC (powers EDID EEPROM chip on some monitors), formerly key
Pin 10	GND	Ground (VSync, DDC)
Pin 11	ID0/RES	Reserved since E-DDC, formerly monitor id. bit 0
Pin 12	ID1/SDA	IC data since DDC2, formerly monitor id. bit 1
Pin 13	HSync	Horizontal sync
Pin 14	VSync	Vertical sync
Pin 15	ID3/SCL	IC clock since DDC2, formerly monitor id. bit 3

## USB Type B

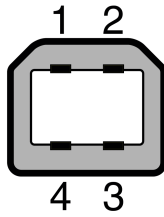

Figure 4.7

Pin	Signal	Color	Description
1	VCC	Red	+5 V
2	D-	White	Data-
3	D+	Green	Data+
4	GND	Black	Ground

The transfer rate depends on the cable length and the type of cable being used.



### Recommended Cables

The following cables are tested and therefore recommended to be used with the DMU3200-\*:

#### USB Touch Screen Cables

Cable	Item Name	Item No.
USB touch screen cable - 6 foot - 1.83 m	UCBL6	546755
USB touch screen cable - 15 foot - 4.57 m	UCBL15	546187

#### Video Cables

Cable	Item Name	Item No.	Picture
VGA Video Cable - 6 foot - 1.83 m	VCBL6	546188	
VGA Video Cable - 15 foot - 4.57 m	VCBL15	546190	
DVI Video Cable - 5 foot - 1.52 m	DVICBL5	546951	
DVI Video Cable - 10 foot - 3.05 m	DVICBL10	546952	
DVI Video Cable - 15 foot - 4.57 m	DVICBL15	546953	

## Power In



Figure 4.8

Pin	Type	Description
1	functional earthing (FE)	Refer to chapter <b>Equipotential Bonding</b> in the VisuNet FLX System or Panel manual for further information.
2	-	
3	+	



### Warning!

If a switch is connected, it must be mechanically secured.

## 4.6

## Commissioning



### Procedure

1. Connect the DMU3200-\* to the network via Ethernet port.
2. Connect your devices via HDMI, DVI-I, VGA or USB Port B. All interfaces provide either a lock mechanism or a mechanical strain relief to protect against vibration.
3. Optional strain relief locking mechanisms can be attached to the HDMI and USB ports.
4. Connect the DMU3200-\* to the DC power supply.



### Warning!

For operation in hazardous areas the interfaces of the DMU3200-\* must be mechanically secured.

The strain relief locking mechanism can be provided by installing the available accessories ATEN-LockPros.

## 4.7

## Information on I/O Devices



### Caution!

The connection of I/O devices can cause faults in the device.

The result may be personal injury and damage to the machine or plant.

- Only connect I/O devices which are approved for industrial applications in accordance with EN 61000-6-2 and IEC 61000-6-2.

- I/O devices that are not hotplug-capable may only be connected after the device has been disconnected from the power supply.

## 5 Maintenance

### 5.1 Opening the Device



#### Procedure

1. Remove the four screws of the back cover.

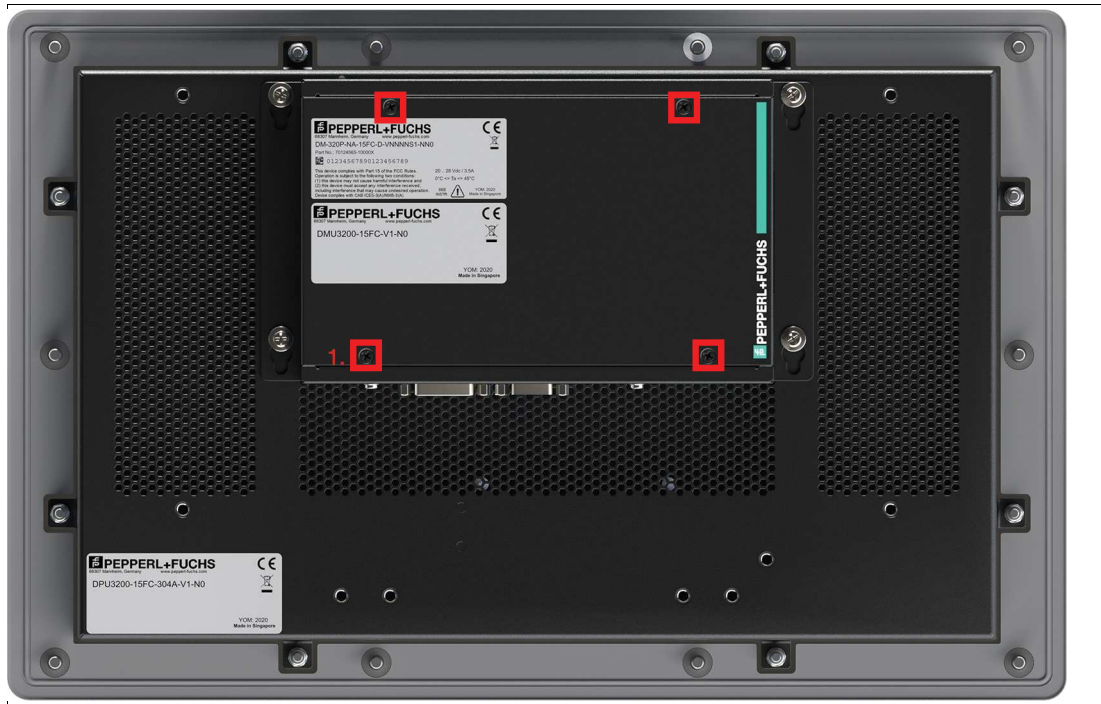

Figure 5.1



2. Remove the cover.

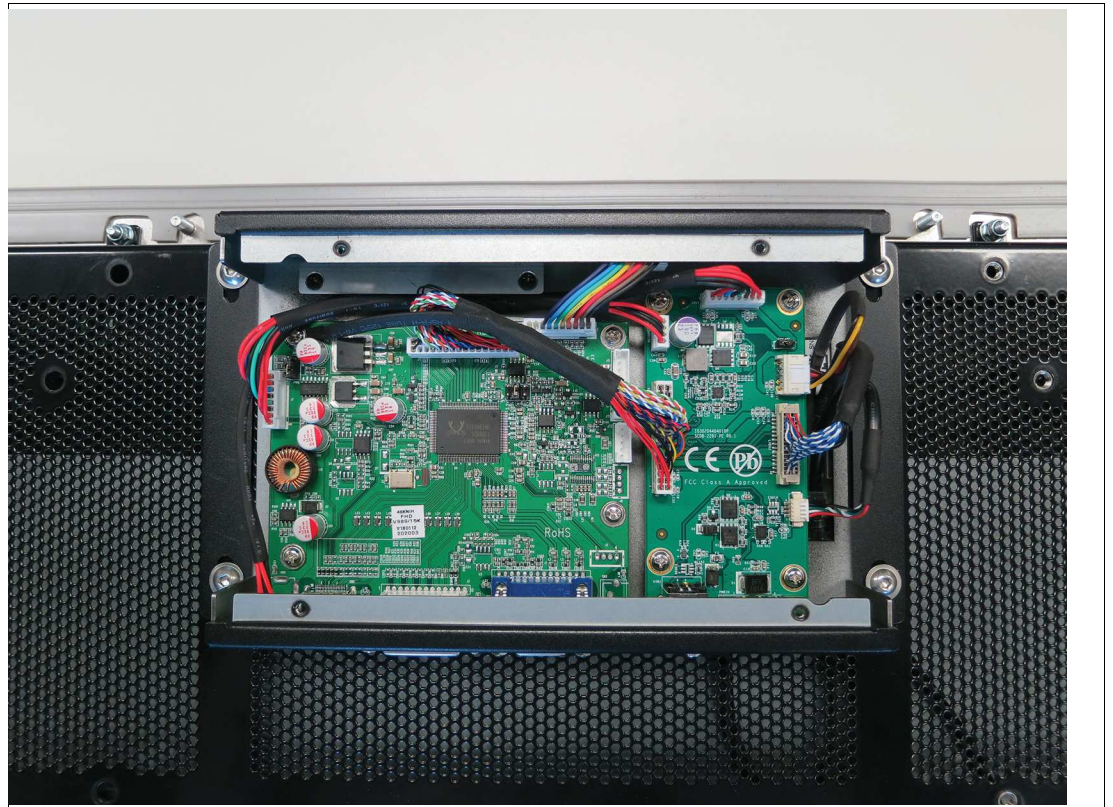

Figure 5.2



**Note**

For further information regarding dismounting the DMU3200-\* from a DPU refer to the VisuNet FLX Panel Mount manual.

# Your automation, our passion.

## Explosion Protection

- Intrinsic Safety Barriers
- Signal Conditioners
- FieldConnex® Fieldbus
- Remote I/O Systems
- Electrical Ex Equipment
- Purge and Pressurization
- Industrial HMI
- Mobile Computing and Communications
- HART Interface Solutions
- Surge Protection
- Wireless Solutions
- Level Measurement

## Industrial Sensors

- Proximity Sensors
- Photoelectric Sensors
- Industrial Vision
- Ultrasonic Sensors
- Rotary Encoders
- Positioning Systems
- Inclination and Acceleration Sensors
- Fieldbus Modules
- AS-Interface
- Identification Systems
- Displays and Signal Processing
- Connectivity

### Pepperl+Fuchs Quality

Download our latest policy here:

[www.pepperl-fuchs.com/quality](http://www.pepperl-fuchs.com/quality)

