

# Multifunctional. Modular.

Identifies, positions and  
measures—with 5 megapixels  
and at the same time.

VOS—2-D Universal Vision Sensor



Your automation, our passion.

 **PEPPERL+FUCHS**

# Simple Solution for Demanding Tasks

**Industrial vision is a key technology for automation. Camera-based sensors from the VOS series take on the difficult tasks of 2-D vision, even in challenging processes and situations. In many applications, a VOS sensor can replace complicated vision systems.**

## **Vision Sensors from Pepperl+Fuchs**

In reality, automation is rarely streamlined. Irregular configurations, highly variable image content, and variations caused by the smallest of differences are all part of the everyday life of industrial production. Negotiating this complexity requires a wide range of optical sensory solutions. Sensors and systems from Pepperl+Fuchs cover the entire spectrum, from simple optical switches to application-specific vision system solutions. The VOS 2-D universal vision sensors close the gap between simple vision sensors and more complex vision systems.

## **Complete Package with Comprehensive Tool Selection**

The camera-based sensors offer a comprehensive range of configuration options. This means that the universal VOS devices can perform a wide variety of automation tasks. An image capture chip, adjustable lenses, lighting, integrated analyzer, digital outputs, and communication interfaces are all packaged in a compact housing. The device software includes a fully equipped, versatile toolbox: The flexibly combinable vision tool set provides suitable algorithms for many standard tasks. It can handle positioning and guidance, detection and calibration, optical gauging and identification, and text recognition (OCR).

### **Highlights**

- Comprehensive, flexibly combinable vision tool set in one camera—for complex tasks without a vision system
- Analyzer integrated in the sensor—for simple integration and user-defined data output
- Graphical user interface for simple commissioning and sensor parameterization
- Modular camera portfolio with standardized connections consisting of a sensor, lighting, and lens



# A Modular Portfolio for Flexible Use

Different measuring distances, challenging lighting scenarios, measuring fields of varying size: The VOS series offers the ideal components for your application.



## Optics, Lighting, and Analysis in One Device

Different parameters can play an important role in vision applications. The VOS vision sensors offer a simple solution for the majority of requirements. With integrated optics, lighting, and electronic analysis, all the key components are housed in one compact device. The lenses can be selected to suit the measurement distance, size of the measurement object, and test criteria. Many models feature an integrated ring light, but external system lighting is also available in the form of side or rear lighting or light and dark field illumination. Standard interfaces and a comprehensive range of accessories allow the sensor to be optimally adapted to the application.



For more information, visit  
[pepperl-fuchs.com/pf-vos](https://pepperl-fuchs.com/pf-vos)

## VOS1000 Series

The compact camera with a resolution of 640 × 480 features an integrated lens and lighting, and an incident light helps the device handle all standard 2-D vision tasks. The camera's adjustable focus is easily set to the desired measuring distance mechanically on the outer ring. This enables the mounting position to be freely selected with a distance to the object between 100 mm and 1,000 mm.



## VOS2000 Series



The sensor offers a resolution of 1280 × 960 and is available in two versions. As a compact camera with integrated lighting, it is especially suitable for standard applications with an incident light. The version with a C-mount connection and standard lenses for industrial cameras handles measurement tasks with more complex exposure scenarios, longer distances, and even greater accuracy.



## VOS5000 Series

The five-megapixel camera with C-mount connection is especially suitable for demanding, high-resolution measuring tasks with larger measuring fields or very complex scenarios. The resolution of 2560 × 2048 covers a measurement field four times larger than that of the VOS2000. A high-performance processor ensures fast analysis of the image data, while the additional lighting output allows the direct connection of an external system lighting.



Excerpt of technical data	VOS1000 	VOS2000 	VOS2000 C-mount 	VOS5000 C-mount 
<b>Resolution</b>	640 × 480	1280 × 960	1280 × 960	2560 × 2048
<b>Lighting</b>	Internal illumination Red, white, blue	Internal illumination Red, white, blue	External lighting	
<b>Read field size</b>	Typically 148 × 111 mm <sup>2</sup> With 8 mm S-mount lens at a read distance of 500 mm	Typically 295 × 221 mm <sup>2</sup>	Typically 200 × 150 mm <sup>2</sup> With 35 mm C-mount lens at a read distance of 1,500 mm	536 × 429 mm <sup>2</sup>
<b>Focus</b>	Mechanically adjustable focus		Adjustable on C-mount lens	
<b>PWR/GPIO</b>	RS232, 3 inputs: freely parameterizable (e. g., as trigger or for job selection), 3 outputs: freely parameterizable (e. g., as strobe control, fail or pass signal)			
<b>Ethernet interface</b>	TCP/IP, PROFINET, EtherNet/IP (other PLCs available on request)			
<b>Integrated vision software</b>	Graphical user interface with measuring tools for detection and calibration, positioning, optical gauging, code reading, text recognition (OCR), programmable data output, and output logic			

# The Perfect Accessories for Every Application

System lighting, lenses, and protective covers in numerous versions: special accessories for individually equipping the VOS2000 compact camera and the VOS5000 five-megapixel camera.



## Precision Lenses for the Sharpest Images

Our portfolio includes industrial lenses with different focal lengths to ensure the optimal field of view at any distance. Their precision optics guarantee low distortion for the largest possible field of view. The focus and aperture can be adjusted manually. Suitable fixing screws are available for applications with vibration or acceleration. The lenses are optimized for the image sensor of the camera type (VOS2000, VOS5000).

The protective covers are tailored to the respective camera as well and are screwed onto the camera over the lens. This ensures IP65 protection.



For more information on accessories, visit [pepperl-fuchs.com/pf-vos-acc](https://pepperl-fuchs.com/pf-vos-acc)

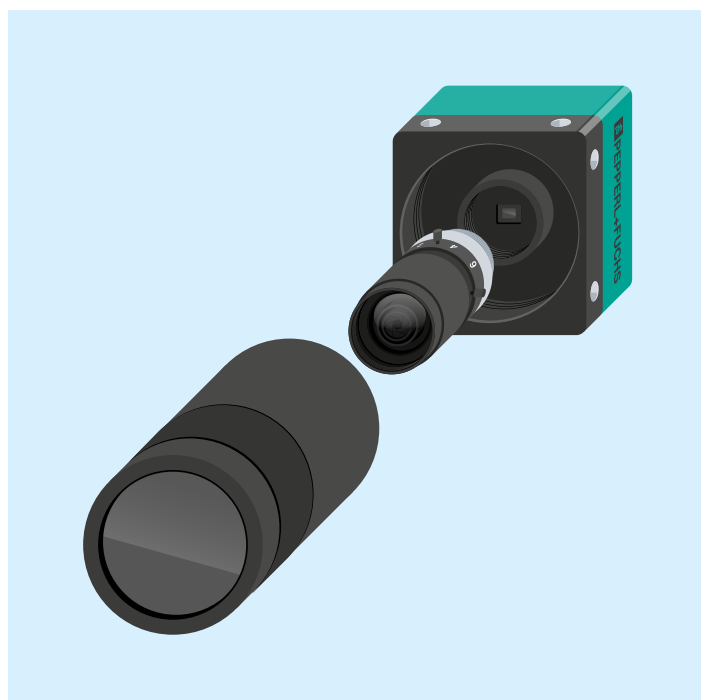

## Highlights

- Flash operation with maximum light output for high-precision image capture and ambient light-safe detection
- Simple parameterization and intelligent lighting control via the software of the VOS universal vision sensor
- Optimum area illumination at all measuring distances due to adjustable light field sizes
- Time savings with plug-and-play installation for the electrical connection of lighting and sensor

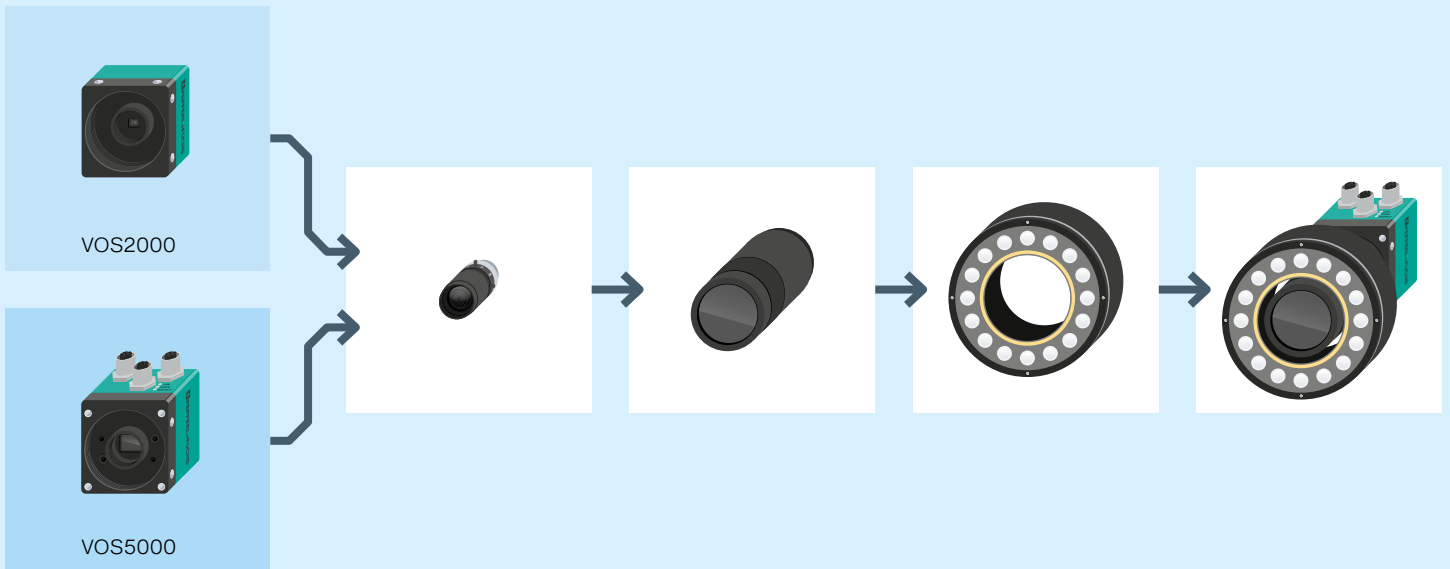

## Optimized Brightness and Flash Time

Various designs and different light field sizes allow optimal area illumination, from very wide to extremely compact fields of view. The portfolio includes ring, spot, bar and area lightings. The integrated flash controller regulates the light output and ensures optimal brightness based on the operating distance. The maximum light output ensures that the detection is protected against extraneous light over long distances. Very short flash times allow reliable detection of fast-moving objects and high-speed codes. Polarization and diffusion filters are available for shiny or transparent surfaces, while a T-cable set simplifies connection and mounting.

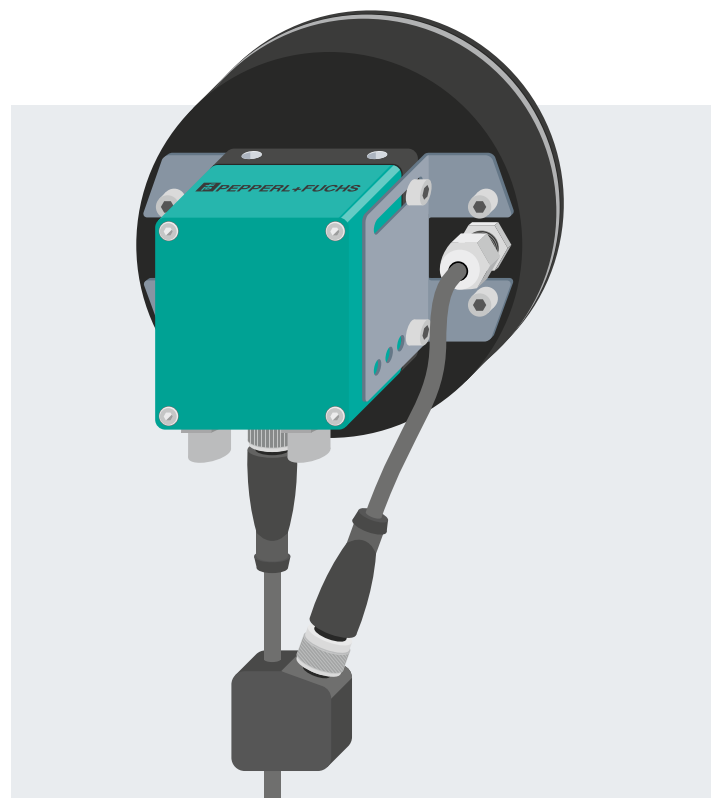

# Integrated Tool Set for Complex 2-D Vision Tasks

The software-supported vision tool set for the VOS series offers a comprehensive toolbox that enables the vision camera to be individually adapted to a wide range of applications.

## Flexible Application-Specific Tool Combinations

The integrated software of the VOS series, which is not subject to additional license costs, includes a comprehensive set of vision tools for setting up and qualifying vision applications and allows graphical parameterization based on a reference image. The tools for different applications that are available in the camera software can be selected and combined to create a measurement task.

This means a code-reading task can be linked to a positioning or object detection task, for example. The same sensor performs different tasks, reducing costs and wiring requirements. The application parameters can be optimized for the specific situation, and Ethernet interfaces and switching outputs allow simple connection to the control panel.

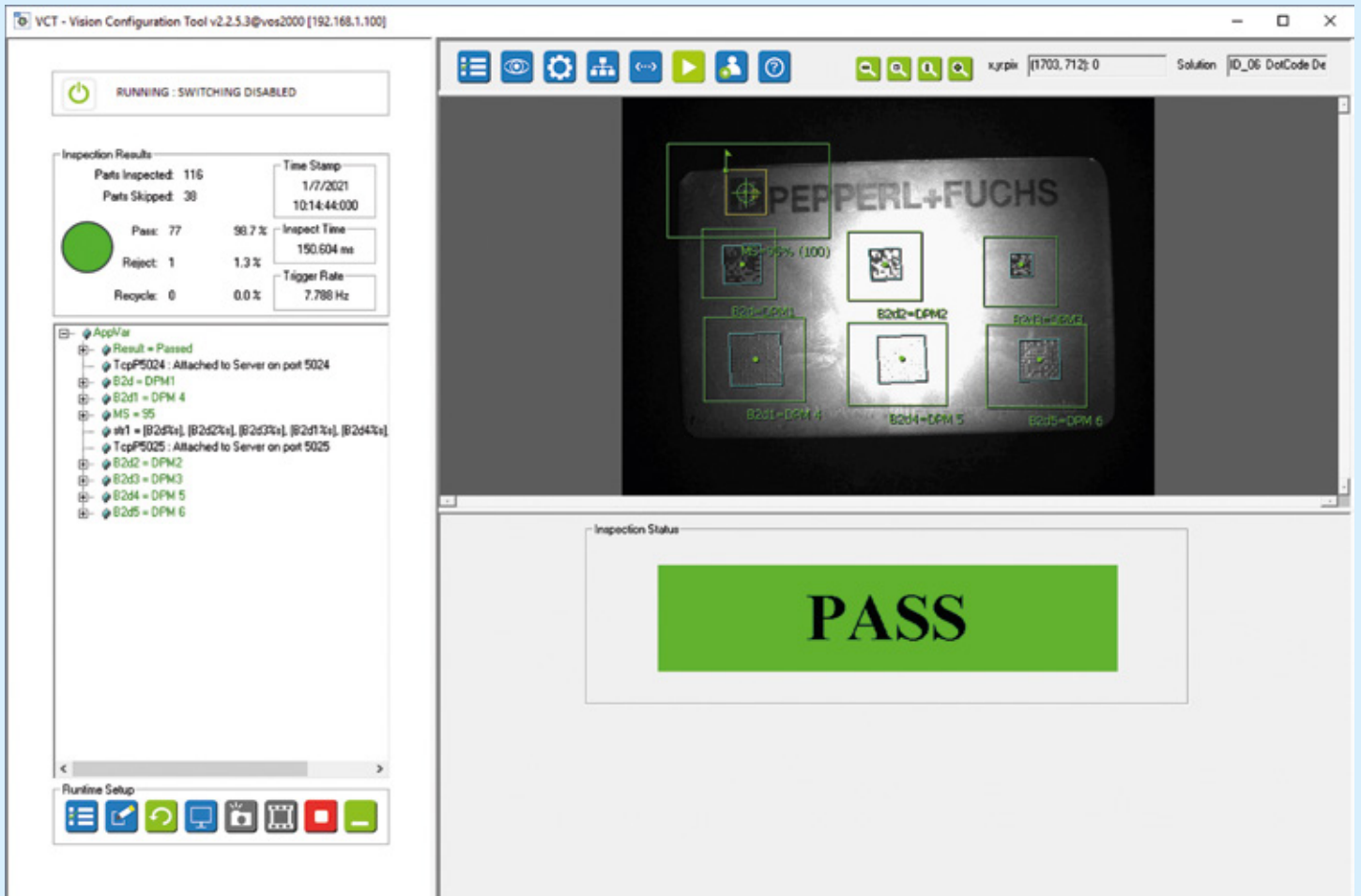



## Simple Commissioning and Reproduction

VOS sensors can be used for a wide variety of applications. Saved jobs can be assigned to a newly installed sensor in just a few steps, and the user can dynamically switch between different jobs. The intuitive user interface allows sensor replacement, commissioning, and job management to be carried out quickly and easily.

The screenshot shows the VCT - Vision Configuration Tool v2.2.5.3@vos2000 [192.168.1.100] interface. The main window displays a camera view of a 'PEPPERL+FUCHS' logo with various detection points (MS, B2d1-B2d5, PP1-PP7) overlaid. The left sidebar contains 'Setup Template', 'Select Tools', and 'Region' sections. The bottom table displays tool configuration details.

Tool	Match	Point	Y	X	Y	X	Min Pass	Perfect	Max Pass	Comments
Match: MS	P1	X			19.715	100%	70	100%	100	
Point: PP6	P1	X			0.03					
Point: PP7	A1	X			0.061					
2D Barcode: B2d3	1	X			3.327	DPM3		*		
Point: PP4	X				0.031					
2D Barcode: B2d5	1	X			38.299	DPM6		*		
Point: PP5	X				0					
2D Barcode: B2d	1	X			3.51	DPM1		*		
Point: PP2	X				0.031					
2D Barcode: B2d1	1	X			72.449	DPM4		*		
Point: PP	X				0					
2D Barcode: B2d4	1	X			34.637	DPM5		*		
Point: PP1	X				0.031					
2D Barcode: B2d2	1	X			2.136	DPM2		*		
Point: PP3	X				0.03					

# Graphical Interface, Intuitive Operation

Simple programming, clear visualization, and preinstalled vision tools simplify operation, even in complex processes and situations.





## Internal Scripting Language for Effortless Programming

The internal scripting language allows comprehensive parameterization and programming: Interfaces, switching outputs, data format, and data output can be adapted to specific applications. Logical links can also be established. The freely programmable digital I/O interfaces can be used as a trigger input or for the output of results. A sensor can take over the primary function for additional VOS devices in a secondary circuit. The vision tools can be combined flexibly across all applications to create specific jobs.

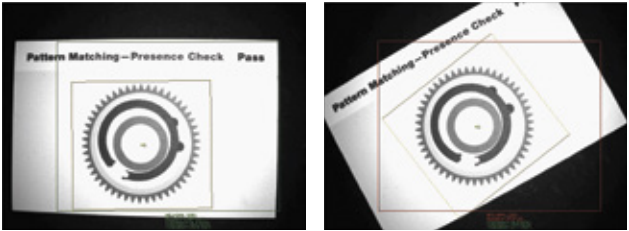
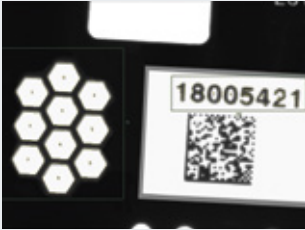
## Remote Diagnostics and Optimization

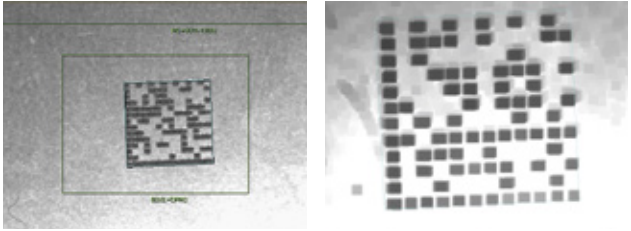
The camera can cache process and error images or automatically transfer them. The parameterization monitor and application monitor can also be accessed remotely. These features allow live monitoring of the process and also allow the user to view process history. In addition to the situation image, the application monitor also displays the measurement result. The increased process transparency helps ensure plant optimization and minimizes failures.

Application	Description	Camera scan
<p><b>Matching tool:</b> Check the presence and position of objects in the image using reference contours or adjoining pixel areas</p>	<ul style="list-style-type: none"> <li>■ Presence detection of a reference contour, number of contours, multiple detection of different contours, and detection of which contour is involved</li> </ul>	
<p><b>Matching tool:</b> Determine the position of an object in the 2-D plane using reference contours</p>	<ul style="list-style-type: none"> <li>■ Output of the position and rotation of a contour to the previously determined reference position</li> </ul>	
<p><b>Counting tool:</b> Automatic detection of object blemishes</p>	<ul style="list-style-type: none"> <li>■ Detection of blemishes in the material during the production process</li> </ul>	

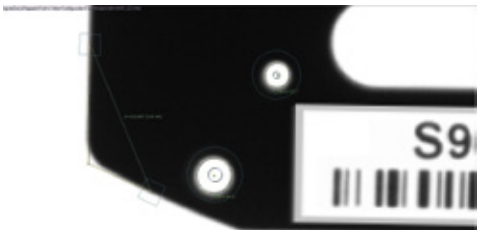
Application	Description	Camera scan
<p><b>Omnidirectional (multiple) reading of standard 1-D and 2-D barcodes</b></p>	<ul style="list-style-type: none"> <li>Output of the code content, optional code position, orientation and code quality according to ISO standard, optimized algorithms for very fast readings</li> <li>Code symbologies: Code 128, Code 39, Int 2 of 5, Codabar, UPC-A/E, EAN-8/13, Code 11, Code 32, Plessey, MSI Plessey, Telepen, BC 412, Pharmacode, DataBar, Postcode, Trioptic</li> <li>2-D code symbologies: Omnidirectional reading of standard 2-D codes such as Data Matrix, QR code, Micro QR code, PDF417, Micro PDF417, Aztec, Han Xin Code, Maxi Code, Grid Matrix, Dotcode</li> </ul>	
<p><b>Precise reading of directly marked (DPM) codes</b></p>	<ul style="list-style-type: none"> <li>Optimized algorithms for reliable reading of DPM codes such as laser-inscribed, etched, and punched codes</li> <li>Output of the code content, optional code position, orientation and code quality according to ISO standard</li> </ul>	
<p><b>Text recognition (OCR): Read complex fonts and characters with different spacing or sizes</b></p>	<ul style="list-style-type: none"> <li>Automatic reading of fonts or directly marked characters on assemblies and mounting parts</li> <li>Different evaluation methods for an optimal result, such as binary, gray, and AI detection</li> </ul>	
<p><b>Text recognition (OCR): Precise matching of important print data on products</b></p>	<ul style="list-style-type: none"> <li>Automatic check of the date code and matching of important print data</li> </ul>	
<p><b>Optical gauging of objects, complex contours, and monitoring of component tolerances</b></p>	<ul style="list-style-type: none"> <li>Reliable detection even for objects moved in XY or twisted objects</li> </ul>	
<p><b>Optical gauging of objects, complex contours, and monitoring of component tolerances</b></p>	<ul style="list-style-type: none"> <li>Standardization of the measured distances to the desired unit (mm or inches) in the 2-D plane</li> <li>Built-in calibration capabilities to reduce distortion of the camera lens</li> </ul>	

# Positioning and Guidance

## Precise Positioning

In automobile production, the wheels are usually fully automatically mounted on the vehicles. A robot gripper mounts the different types of rims on the wheel hubs. The VOS vision sensor determines the exact position of the rim in relation to the wheel hub. A preinstalled vision tool accurately reports the orientation and position of the rim bolt circle in a 2-D plane to the robot. New rim types can be learned via teach-in.

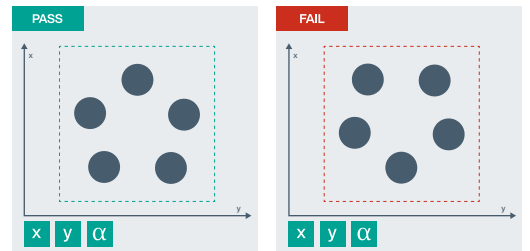
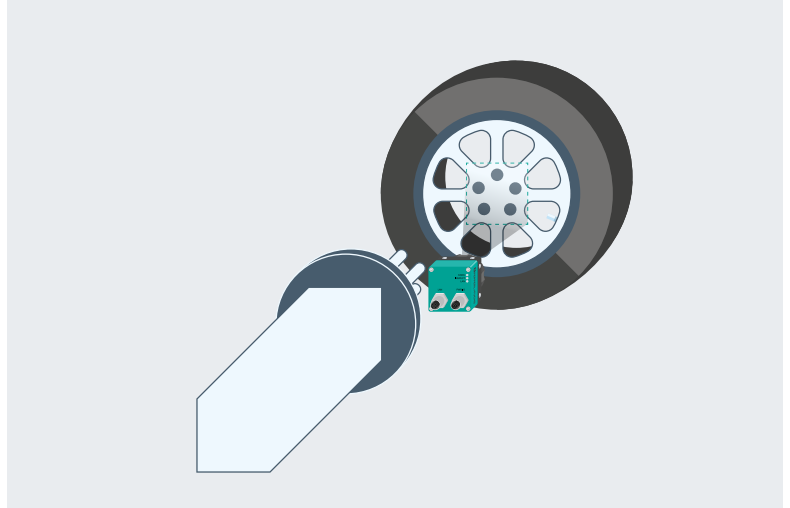

## Precise Position Determination

Robots are often used for sorting individual products into shipping packages. They require an exact position of the object, which is usually located inside a packing bag. The VOS vision sensor uses a stored vision tool to calculate orientation and position and to pass the data on to the robot. New object shapes can be taught in dynamically, and zero-point referencing is also possible. Different types of objects are detected and assigned in the same process. The flexibly formatted data output allows simple connection to the robot control system.

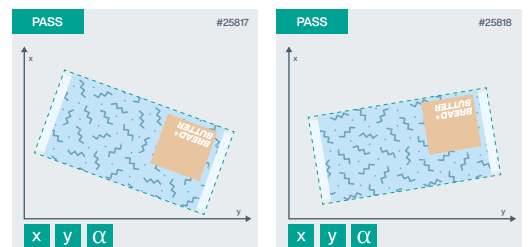
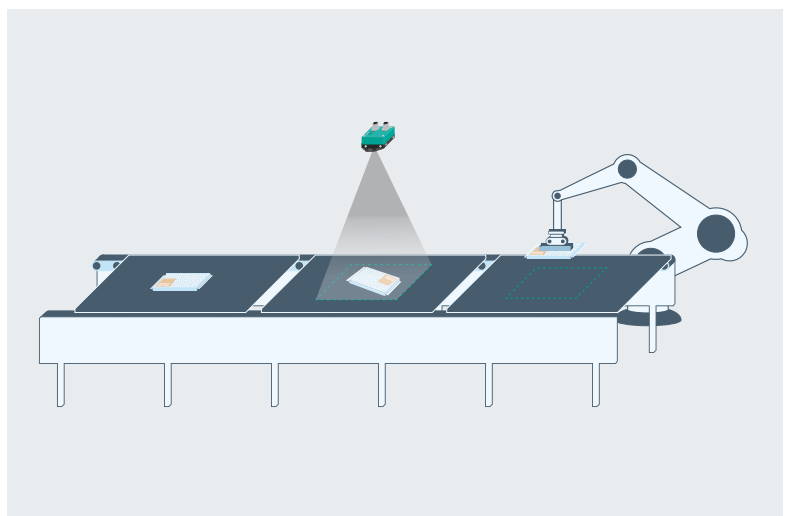

# Detection and Calibration

## Reliable Visual Inspection

For quality assurance purposes, engine blocks undergo thorough visual inspection after casting. The aim is to ensure that there are no casting residues or sand from the mold still on the block; any casting defects should be detected before the subsequent mounting steps are carried out. With the vision tool for characteristic checks, the camera automatically detects the presence and exact position of defined features (e. g., orientation of a hole). Any defects such as remaining burrs and incorrect holes are visually identified. Multiple features can be checked simultaneously. The test results can be output via data interface or switching output.

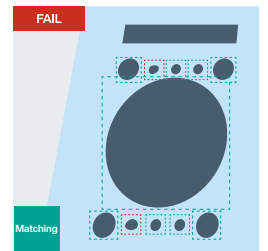
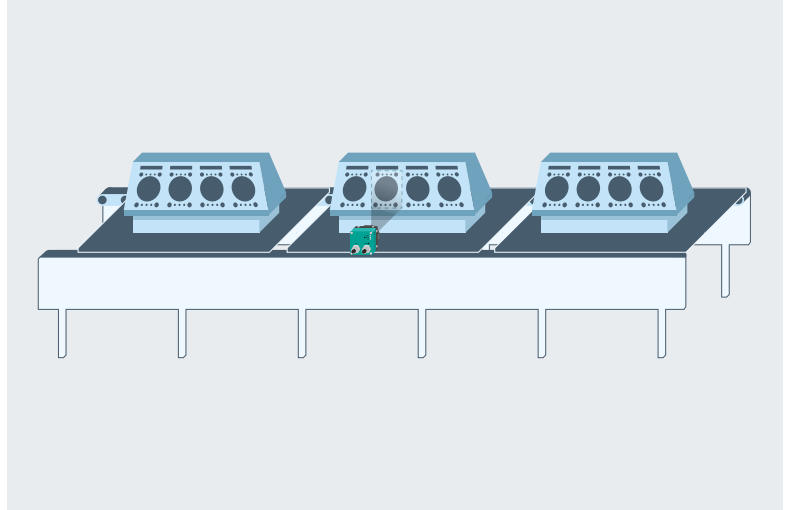

## Quality Control with a High Throughput

In filling plants, bottles are automatically filled, labeled, and sealed. Bottles with misaligned labels or wonky caps must be sorted and removed at very high movement speeds. The VOS vision sensor offers a vision tool that guarantees complete quality control at a high measuring rate. The position of the label and the sealing cap is checked in the same step. The global shutter principle of the sensor ensures a distortion-free image. A hardware trigger (e. g., light barrier) enables precise time control of the image capture.

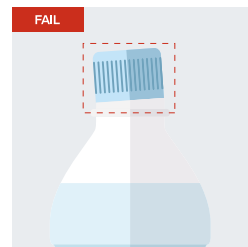
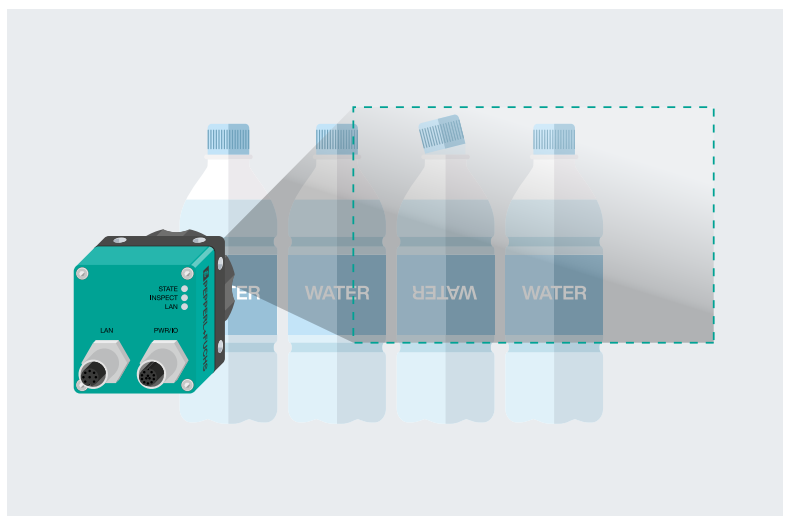

# Identification and Text Recognition (OCR)

## Reading Directly Marked Codes

In the automotive industry, for example, safety-relevant components in particular are identified with codes and direct part marking for quality control and seamless traceability. On metal surfaces, the lighting can cause strong reflections, while additional light sources and fluctuating ambient light in the measuring environment can act as an optical disturbance. The comprehensive range of lighting for the VOS cameras enables reliable reading of the codes—even in difficult conditions and at larger measurement distances. Special vision tools ensure that markings with different fonts and code symbologies are reliably detected and read out.

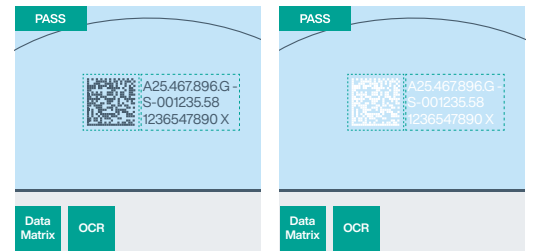
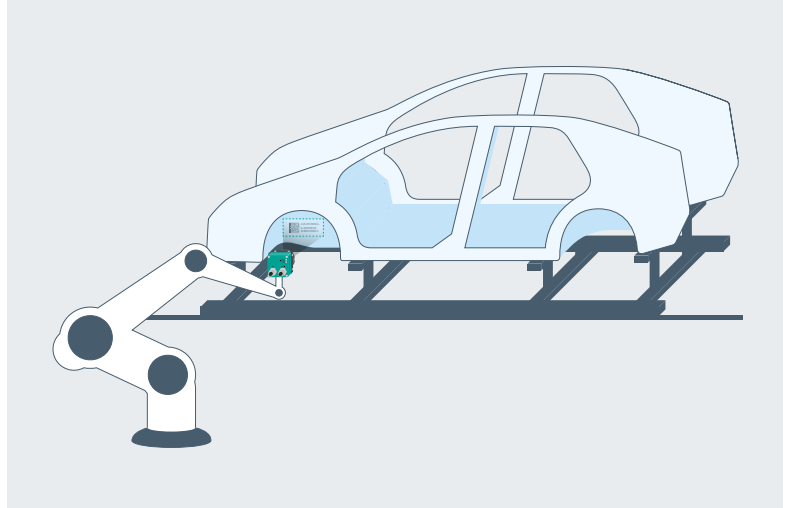

## Multi-Code Reading for Printed Circuit Boards

This application involves several printed circuit boards (PCBs), which are separated from each other in a later production step. The boards are already marked individually for quality control, usually with a Data Matrix code. This can be glued on or applied as direct part marking (DPM code) by etching or laser inscribing. With a vision tool configured for this task, the codes of all printed circuit boards can be read and output simultaneously in a single application. Specific algorithms can be selected for directly marked codes. Other options include the detection of the geometric position and the print quality of the code. The output string can also be flexibly adjusted.

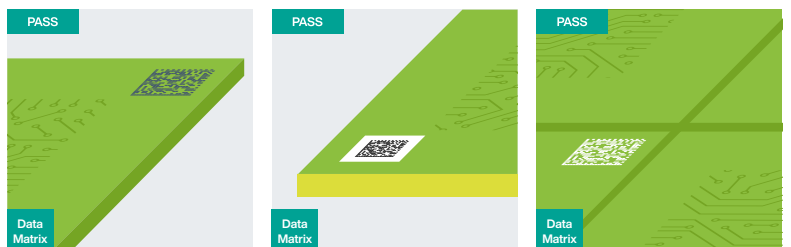
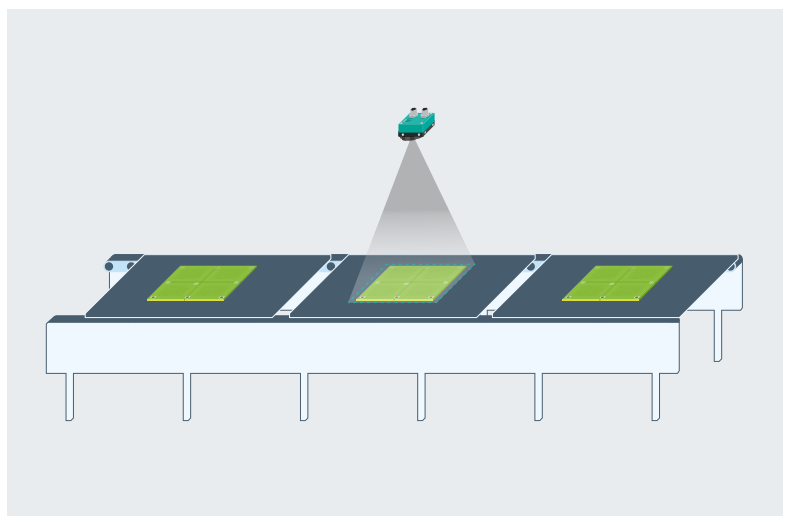

# Optical Gauging

## Final Geometric Inspections

The final inspection of high-quality or safety-critical components involves narrow tolerances to within fractions of a millimeter. Even small deviations could lead to vibrations, damage, or even dangerous situations. A vision tool can help with this: It takes care of the measurement of circle diameters, length dimensions, and complex shapes. The values can either be sent to the higher-level control system or used directly as a pass/fail switching signal. Length units are automatically converted to a metric length value following a calibration on the 2-D plane. A calibration checkerboard also allows precise correction of the lens distortion.

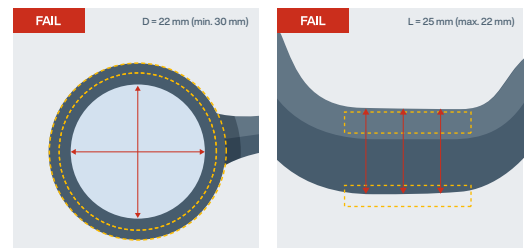
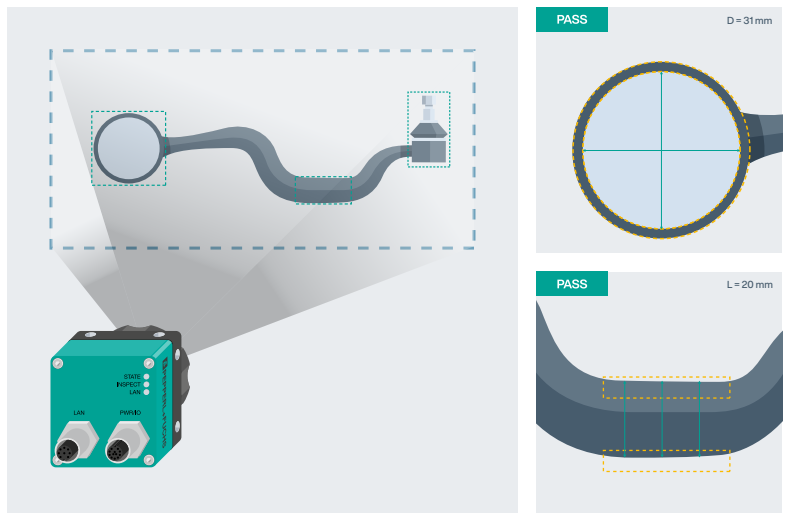
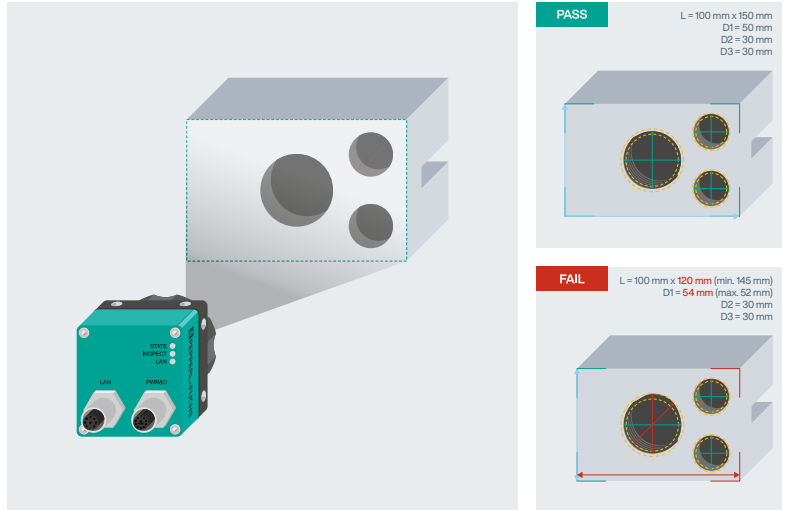

# Your automation, our passion.

## Explosion Protection

- Intrinsic Safety Barriers
- Signal Conditioners
- FieldConnex® Fieldbus Infrastructure
- Remote I/O Systems
- Electrical Explosion Protection Equipment
- Purge and Pressurization Systems
- HMI Systems
- Mobile Computing and Communications
- HART Interface Solutions
- Surge Protection
- Wireless Solutions
- Level Measurement

## Industrial Sensors

- Proximity Sensors
- Photoelectric Sensors
- Industrial Vision
- Ultrasonic Sensors
- Rotary Encoders
- Positioning Systems
- Inclination and Acceleration Sensors
- Vibration Sensors
- Industrial Ethernet
- AS-Interface
- IO-Link
- Identification Systems
- Displays and Signal Processing
- Connectivity

[www.pepperl-fuchs.com](http://www.pepperl-fuchs.com)

Subject to modifications • © Pepperl+Fuchs  
Printed in Germany • Part. No. 70135320 10/22 02 • public



**Pepperl+Fuchs Quality**

Download our latest policy here:

[www.pepperl-fuchs.com/quality](http://www.pepperl-fuchs.com/quality)