

**PGV100R-F213-R4-1.5M**

**Incident Light Positioning  
System**

**Manual**

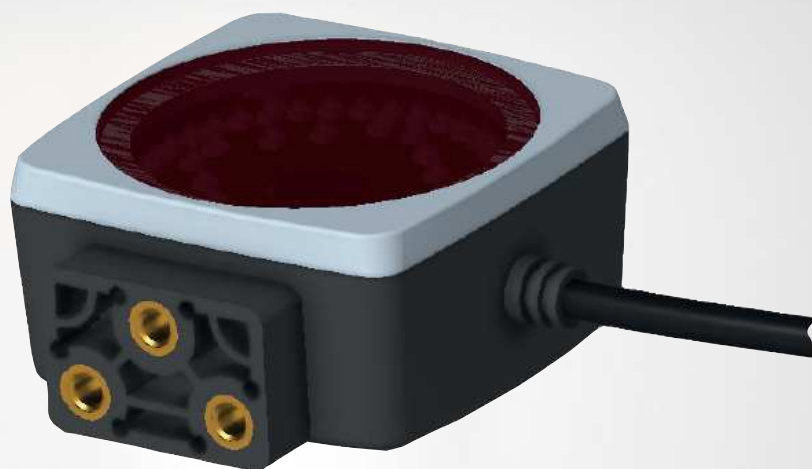

---

With regard to the supply of products, the current issue of the following document is applicable:  
The General Terms of Delivery for Products and Services of the Electrical Industry, published  
by the Central Association of the Electrical Industry (Zentralverband Elektrotechnik und Elek-  
troindustrie (ZVEI) e.V.) in its most recent version as well as the supplementary clause:  
"Expanded reservation of proprietorship"

**Worldwide**

Pepperl+Fuchs Group  
Lilienthalstr. 200  
68307 Mannheim  
Germany  
Phone: +49 621 776 - 0  
E-mail: [info@de.pepperl-fuchs.com](mailto:info@de.pepperl-fuchs.com)

**North American Headquarters**

Pepperl+Fuchs Inc.  
1600 Enterprise Parkway  
Twinsburg, Ohio 44087  
USA  
Phone: +1 330 425-3555  
E-mail: [sales@us.pepperl-fuchs.com](mailto:sales@us.pepperl-fuchs.com)

**Asia Headquarters**

Pepperl+Fuchs Pte. Ltd.  
P+F Building  
18 Ayer Rajah Crescent  
Singapore 139942  
Phone: +65 6779-9091  
E-mail: [sales@sg.pepperl-fuchs.com](mailto:sales@sg.pepperl-fuchs.com)  
<https://www.pepperl-fuchs.com>

<b>1</b>	<b>Introduction.....</b>	<b>4</b>
1.1	Content of this Document.....	4
1.2	Target Group, Personnel .....	4
1.3	Symbols Used .....	5
<b>2</b>	<b>Product Description .....</b>	<b>6</b>
2.1	Use and Application .....	6
2.2	RS-485 Interface .....	7
2.3	LED Indicators .....	8
2.4	Accessories.....	9
<b>3</b>	<b>Installation.....</b>	<b>10</b>
3.1	Mounting the Read Head.....	10
3.2	Affixing the Code Tape .....	11
3.3	Electrical Connection .....	21
<b>4</b>	<b>Commissioning.....</b>	<b>22</b>
4.1	Direction Decision .....	22
4.2	Parameterization Using Code Cards.....	23
4.2.1	The code cards "CANCEL", "USE", and "DEFAULT" .....	24
<b>5</b>	<b>Operation and communication.....</b>	<b>25</b>
5.1	Communication via the RS-485 Interface.....	25
5.1.1	Request Telegram.....	25
5.1.2	Position Response Telegram .....	26
5.1.2.1	Orientation O .....	30
5.1.2.2	Side S .....	30
5.1.2.3	Position/Lane .....	32
5.1.3	Direction Decision Request Telegram .....	32
5.2	Operation Using Control Codes .....	33
5.3	Operation in case of repair .....	34
5.4	Electrical switching output .....	34
<b>6</b>	<b>Appendix .....</b>	<b>35</b>
6.1	Code Cards for External Parameterization.....	35
6.1.1	Code Cards with Special Functions .....	35
6.1.2	Code Cards for Setting the Read Head Address .....	38
6.1.3	Code cards for setting the transfer rate .....	40
6.1.4	Code Cards for Adjusting the Resolution .....	42
6.1.5	Code cards for adjusting the terminator .....	43

# 1 Introduction

## 1.1 Content of this Document

This document contains information required to use the product in the relevant phases of the product life cycle. This may include information on the following:

- Product identification
- Delivery, transport, and storage
- Mounting and installation
- Commissioning and operation
- Maintenance and repair
- Troubleshooting
- Dismounting
- Disposal



---

### Note

For full information on the product, refer to the further documentation on the Internet at [www.pepperl-fuchs.com](http://www.pepperl-fuchs.com).

---

The documentation comprises the following parts:

- This document
- Datasheet

In addition, the documentation may comprise the following parts, if applicable:

- EU-type examination certificate
- EU declaration of conformity
- Attestation of conformity
- Certificates
- Control drawings
- Instruction manual
- Other documents

## 1.2 Target Group, Personnel

Responsibility for planning, assembly, commissioning, operation, maintenance, and dismantling lies with the plant operator.

Only appropriately trained and qualified personnel may carry out mounting, installation, commissioning, operation, maintenance, and dismantling of the product. The personnel must have read and understood the instruction manual and the further documentation.

Prior to using the product make yourself familiar with it. Read the document carefully.

## 1.3 Symbols Used

This document contains symbols for the identification of warning messages and of informative messages.

### Warning Messages

You will find warning messages, whenever dangers may arise from your actions. It is mandatory that you observe these warning messages for your personal safety and in order to avoid property damage.

Depending on the risk level, the warning messages are displayed in descending order as follows:



---

#### **Danger!**

This symbol indicates an imminent danger.

Non-observance will result in personal injury or death.

---



---

#### **Warning!**

This symbol indicates a possible fault or danger.

Non-observance may cause personal injury or serious property damage.

---



---

#### **Caution!**

This symbol indicates a possible fault.

Non-observance could interrupt the device and any connected systems and plants, or result in their complete failure.

---

### Informative Symbols



---

#### **Note**

This symbol brings important information to your attention.

---



---

#### **Action**

This symbol indicates a paragraph with instructions. You are prompted to perform an action or a sequence of actions.

## 2 Product Description

### 2.1 Use and Application

#### Intended Use

This device, when used together with a Data Matrix code tape affixed to the floor, constitutes a high-resolution lane tracking and positioning system. It can be used in all applications where auto-guided transport systems are to be positioned precisely at marked positions along a given lane.

The read head forms part of the positioning system in the Pepperl+Fuchs incident light process. The read head includes a camera module and an internal illumination unit, which the read head uses to detect a strip of Data Matrix code tape stuck to the floor for lane tracking and navigation. The read head also detects Data Matrix tags to navigate within a grid.

The read head is located on an auto-guided transport system and guides this system along the Data Matrix code tape.

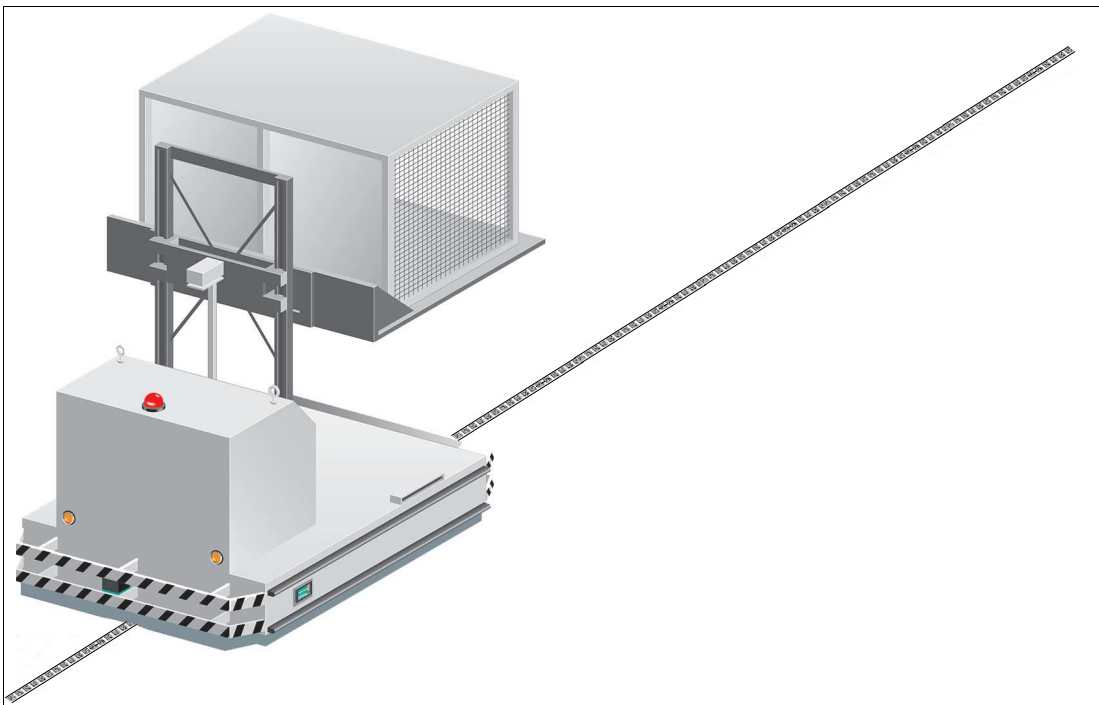

Figure 2.1 Auto-guided transport system with Data Matrix code tape

### Tag Mode

In addition to lane tracking, the read head can also be used in tag mode. The read head detects Data Matrix tags, which are typically glued onto the floor in a grid. The individual Data Matrix tags are numbered consecutively and include position information. The read head reports the position of the auto-guided transport system in relation to the zero point of the Data Matrix tag to the control panel.

Tag mode allows the auto-guided transport system to move freely in as large a grid as desired, without having to mark the traverse distances with code tapes.

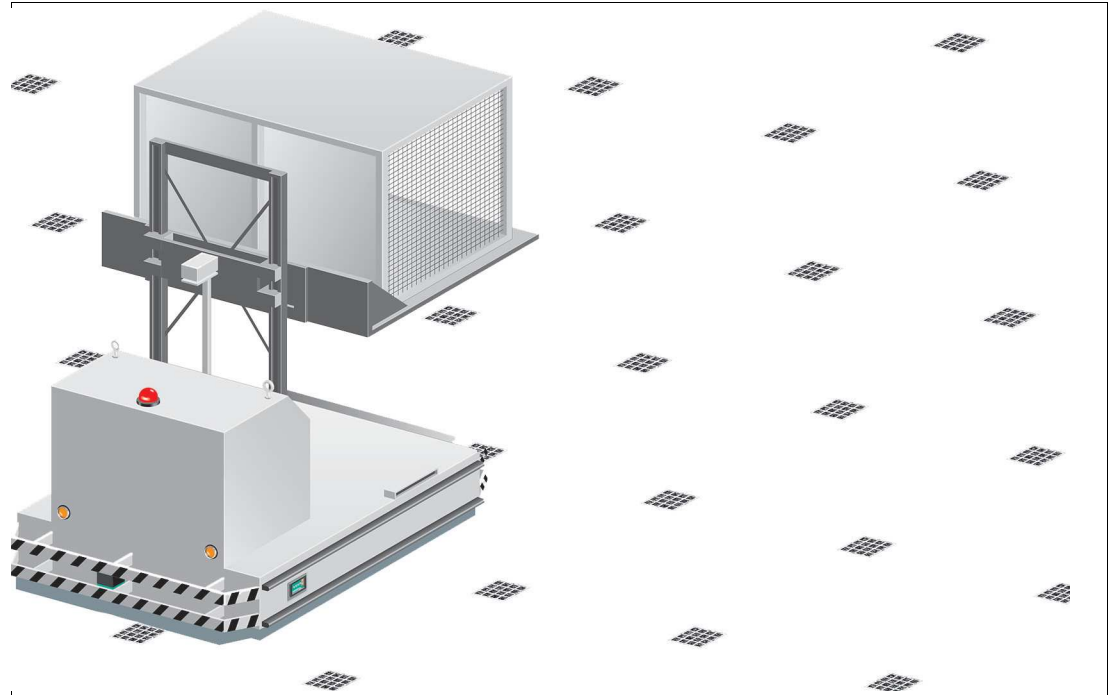

Figure 2.2 Auto-guided transport system with Data Matrix tags

The read head switches automatically between tag mode and lane tracking. This allows a transport system to be guided from one Data Matrix tag grid to another via a Data Matrix code tape.

Thanks to its comprehensive and simple parameterization options, the read head can be optimally adapted to suit any application.

## 2.2 RS-485 Interface

The read head is equipped with an RS-485 interface for communication purposes, i.e. parameterizing the read head functions or reading out current process data during operation. This interface is operated in 8-E-1 operating mode and is fitted with a terminator that can be activated or deactivated by parameterizing the sensor head. The RS-485 interface supports the following transfer rates:

- 9600 bit/s
- 19200 bit/s
- 38400 bit/s
- 57600 bit/s
- 76800 bit/s
- **115200 bit/s** (default value)

### Data structure of the RS-485 interface

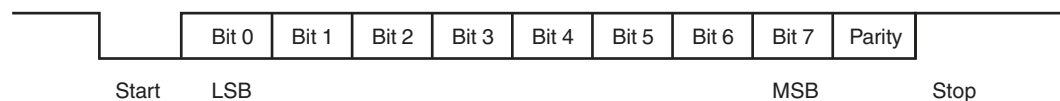

### 2.3 LED Indicators

The read head is equipped with two indicator LEDs for carrying out visual function checks and quick diagnostics.

#### LEDs

LED	Color	Label	Meaning
1	Green/yellow	COM STATE	RS-485 communication active
2	Green/red	POWER ON NO CODE/ ERROR	Code detected/not detected, error

Table 2.1 LEDs

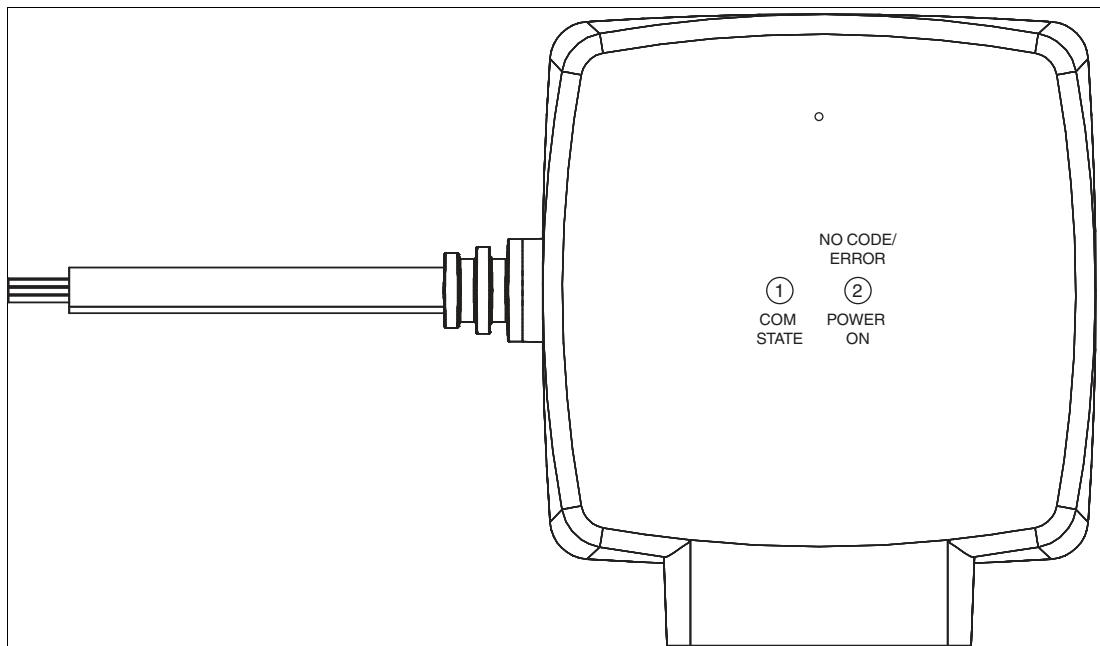

Figure 2.3 Display elements

#### Function Indicator LED

LED	1		2		Description
	COM STATE	COM ERROR	POWER ON	NO CODE/ ERROR	
Color	Green	Yellow	Green	Red	
State	Off	Flashing	x	x	Comunikation aktive
	Off	Off	x	x	No communication

Table 2.2  $f_{\text{flash}} = 2.5 \text{ Hz}$  (one request line for flashing with three on statuses)  
x: LED status has no meaning



LED	1		2		Description
Mode	COM STATE	COM ERROR	POWER ON	NO CODE/ ERROR	
Color	Green	Yellow	Green	Red	
State	x	x	Lights up	Off	Codes detected
	x	x	Off	Flashing	Codes not detected
	x	x	x	Lights up	System error
	x	x	Lights up for 1 s	Off	Code card read
	x	x	Off	Lights up for 1 s	Code card not read

Table 2.3 Sensor switched on: At least one of the LEDs is lit or flashing  
x: LED status has no meaning

## 2.4 Accessories

Compatible accessories offer enormous potential for cost savings. Such accessories not only save you a great deal of time and effort during initial commissioning, but also when replacing and maintaining our products.

If products are used in harsh ambient conditions, appropriate Pepperl+Fuchs accessories can be used to extend the service life of these products.

Model number	Description
PGV*-CA25-*	Data Matrix code tape
PGV-CC25-0*	Data Matrix control codes
PGV*M-CA25-*	Data Matrix positioning tape
PGV85-CT4	Data Matrix tag
PGV25M-CD100-CLEAR	Protective film

Table 2.4 Accessories

## 3 Installation

### 3.1 Mounting the Read Head

Mount the read head on the auto-guided transport system using the four screws on the mounting adapter on the read head. Mount the read head so that the lens with ring light and camera module are aligned toward the floor.

The mounting must be stable enough so that the read head does not leave its depth of focus range during operation.

The distance between the read head and the floor should be the same as the read distance of the read head.

#### Optimum Read Distance

Model number	Read distance [mm]	Depth of focus [mm]	Field of vision (w x h) [mm]
PGV100R*	100	±30	115 x 73

#### Read Head Dimensions

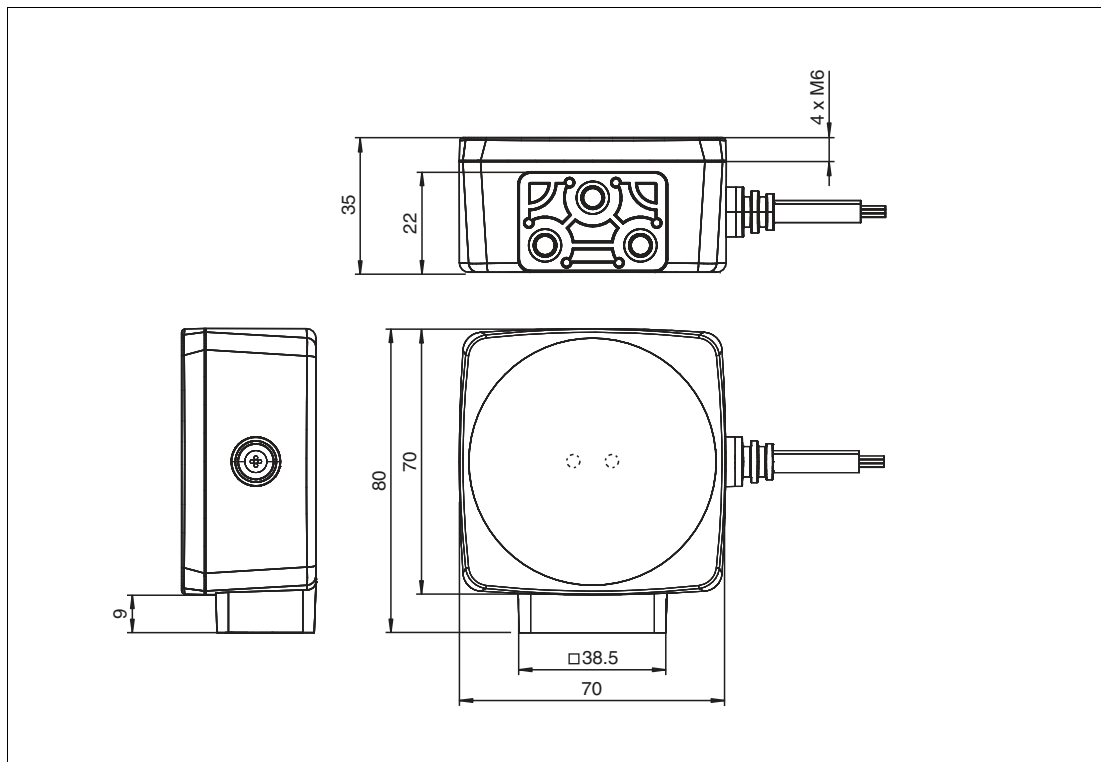

Figure 3.1 Housing dimensions



#### Caution!

When selecting the length of the mounting screws, ensure that the maximum insertion depth of the screws in the threaded inserts on the read head is 8 mm.

Using longer screws may damage the read head.



#### Caution!

The maximum torque of the mounting screws must not exceed 9 Nm.

Tightening the screws to a higher torque may damage the read head.

### 3.2 Affixing the Code Tape

#### Dimensions of the Code Tape

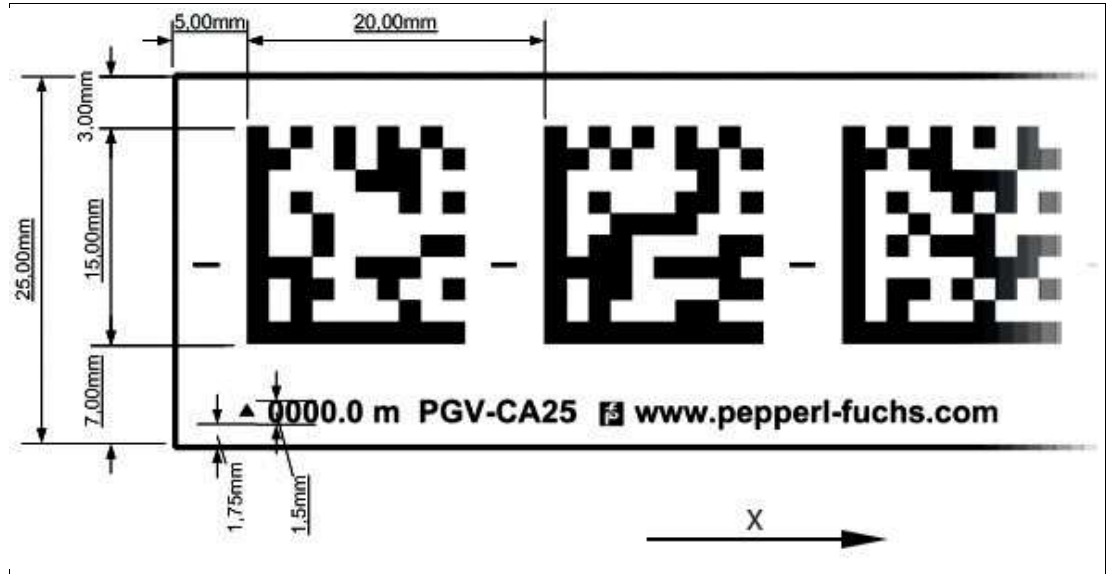

Figure 3.2 Dimensions of the Data Matrix code tape



**Caution!**

**Alignment**

The Data Matrix code is not on the center line of the code tape.



**Caution!**

**Stop edges**

If you attach another code tape at the end of a previous code tape, the code pattern of 20 mm must be retained.

The code tape is made of silicone-free polyester film. A position marker appears every 100 mm along the lower edge of the code tape (see "Code Tape Dimensions"). These position markers are used to affix the code tape in the correct position.

The back of the code tape is covered with a modified acrylate-based adhesive designed for permanent adhesion. Affix the self-adhesive code tape along the desired traverse distance. To do so, proceed as follows:

Position the code tape so that the **www.pepperl-fuchs.com** label and the position markings are to the right of the Data Matrix code in the X direction. The position values then increase along the X direction.

**Data Matrix Code Tapes with a Starting Position of 0 m**

Model number	Description
PGV10M-CA25-0	Code tape, length: 10 m
...	...
PGV100M-CA25-0	Code tape, length: 100 m

Table 3.1 Data Matrix code tapes  
See also data sheet PGV\*-CA25-\* at [www.pepperl-fuchs.com](http://www.pepperl-fuchs.com)

**Data Matrix Control Codes**

Model number	Description
PGV-CC25-001	Code tape, Control Code 001, length: 1 m
...	...
PGV-CC25-999	Code tape, Control Code 999, length: 1 m

Table 3.2 Data Matrix control codes



**Affixing the Code Tape**

1. Clean the surface of any greasy or oily deposits and dust.
2. Ensure that the surface is dry, clean, and stable.
3. Pull away a few centimeters of the protective film at the beginning of the code tape. Place the code tape at the precise point of the required starting position on the surface, and press to attach.
4. Then affix the code tape along the desired traverse distance. Please note the following information:
5. Remove the protective film gradually so that the code tape does not accidentally adhere to the surface in an incorrect position. When affixing the code tape, ensure that it does not become creased or trap air bubbles.

↳ The adhesive on the code tape hardens after 72 hours.



**Note**

**Thermal Expansion of the Code Tape**

The affixed code tape corresponds to the heat expansion coefficient of the surface with regard to its thermal expansion. Keep this in mind when installing expansion joints, for example.



**Note**

**Expansion Joints and Code Tapes**

If the system covers longer distances, the plant structure usually contains expansion joints. In this case, we recommend creating breaks along the code tape. The resulting gap must not exceed 75 mm.

**Note****Mounting the code tape in curved areas**

If you affix the code tape on inclines or declines, cut the code tape several times at the transition point to the horizontal as shown.

When you apply the code tape to the floor in curved areas, cut the code tape several times at the transition to the curve as shown. Be careful not to destroy any DataMatrix codes and leave a resting zone of 2 mm to avoid damaging the codes.

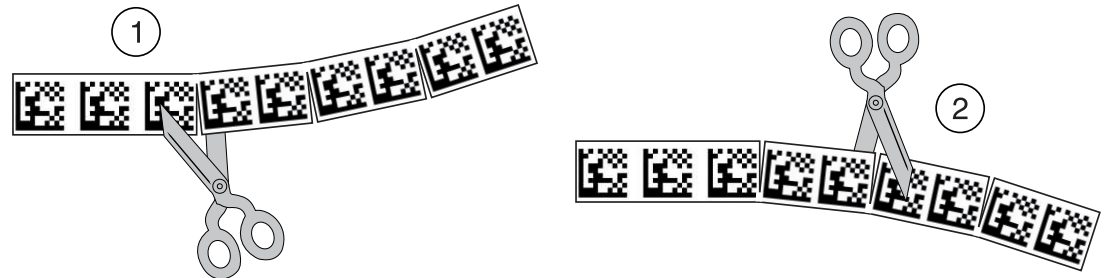

Figure 3.3 Schematic diagram: preparing Data Matrix code tape bends

1. Bend to the left
2. Bend to the right

**Cleaning the Code Tape**

Significant contamination on code tapes can impair detection by the read head. Clean the code tapes with isopropanol if necessary. If the contamination is severe, you can use a non-corrosive plastic cleaner, e.g., Caramba®.

**Note**

To avoid polishing the surface, do not apply strong pressure when cleaning. If the code tape has a shiny surface, this impairs detection by the read head.

## Angle Output



### Note

Angles are specified as absolute values. The respective value is calculated from the resolution selected under "Angle Resolution." With a resolution of  $0.1^\circ$ , an angle of  $60^\circ$  is output as  $60^\circ/0.1^\circ = 600$ .

The read head detects the absolute angle in relation to the tracked lane with a maximum resolution of  $0.1^\circ$ . The angle is specified as an absolute value relative to the tracked lane, as a Data Matrix code tape contains direction information. The output angle covers the range from  $0^\circ$  to  $360^\circ$ . The resolution can be set to the following values:

- $0.1^\circ$
- $0.2^\circ$
- $0.5^\circ$
- $1^\circ$

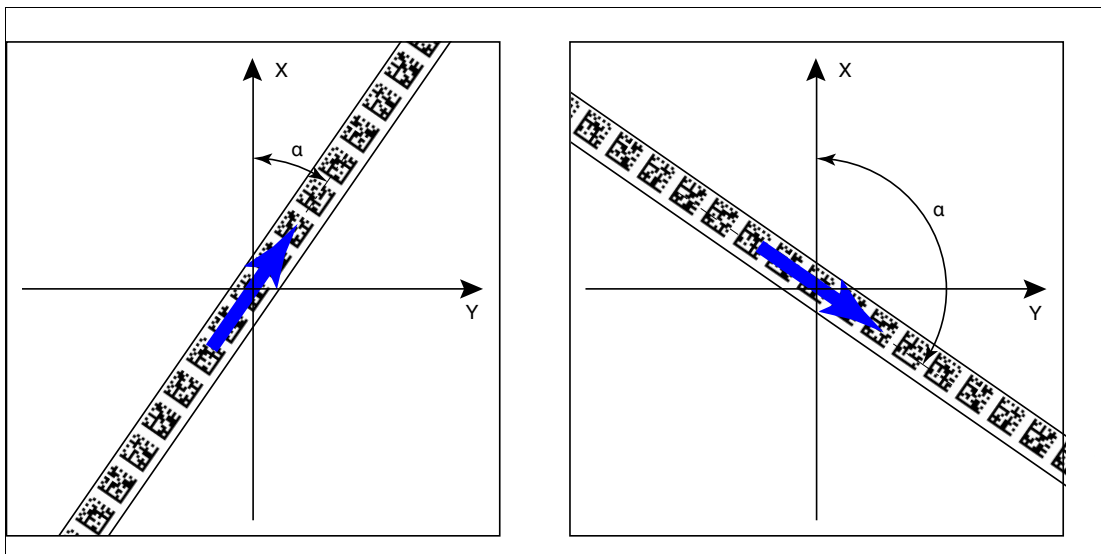

Figure 3.4 Absolute angle

### Distance Output

The read head detects the distance from the zero point in the Y direction a Data Matrix code tape and transmits this value to the control panel.

The reader indicates the vertical distance of the zero point in relation to the Data Matrix code tape.

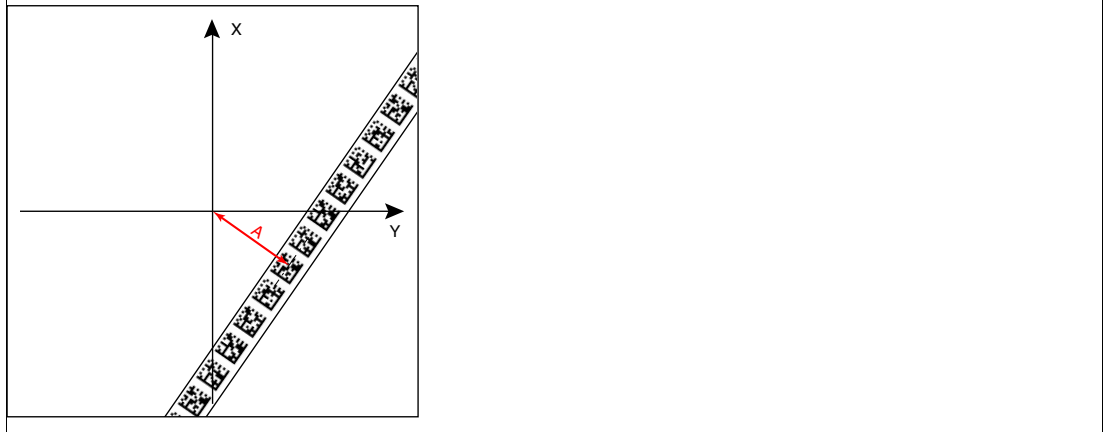

Figure 3.5 Distance A for Data Matrix code tape



#### Note

##### Branches/Intersections with Data Matrix Position Code

Observe the following guidelines with regard to the area 1 m before and after branches or intersections of a lane with a position code:

- The position codes of the main lane must run continuously for 2 m. The position codes of the branching/intersecting lane must run continuously for 1 m. The read head outputs the X-value of the Data Matrix code tape that is specified via the direction decision. See figure below.
- The difference between the absolute position of the main lane and the starting position of the branching/intersecting lane must be greater than 1 m.

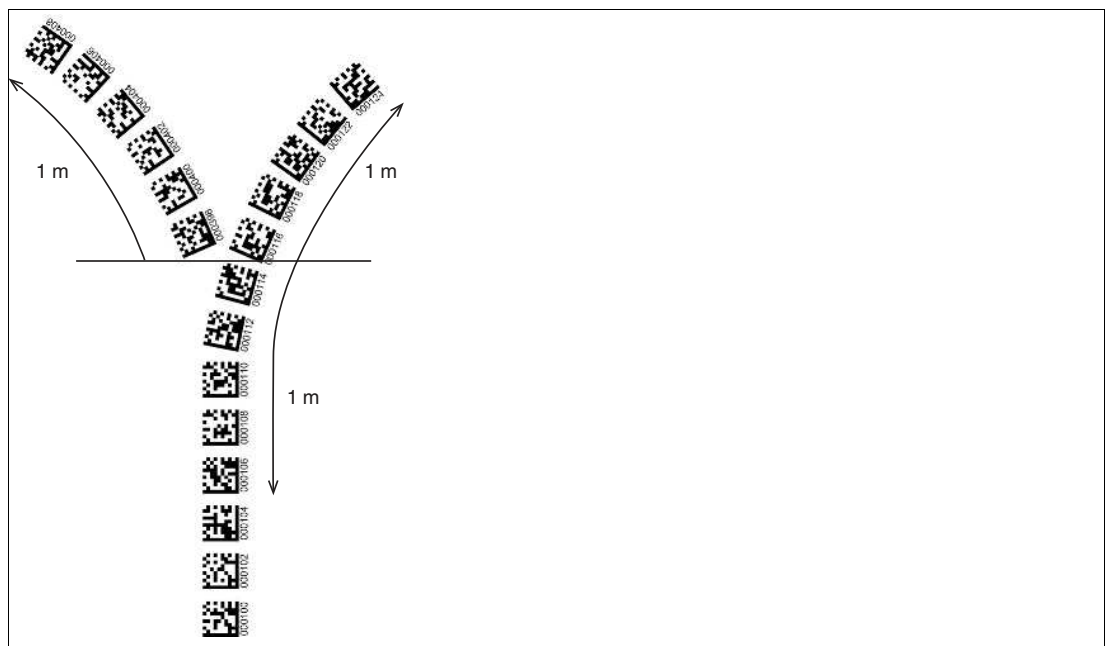

Figure 3.6 Distances

## Behavior of the Read Head at Branches and Curves

The read head behaves differently depending on the type of branch and the specified lane. The read head must know the upcoming direction decision.

- A second lane branches off to the left from the straight lane:
  - » The read head follows the straight lane if the direction decision "follow right-hand lane" has been made.
- A second lane branches off to the right from the straight lane:
  - » The read head follows the straight lane if the direction decision "follow left-hand lane" has been made.
- A single lane with a position code turns to the left or right:
  - » The read head follows the position code if the direction decision "straight ahead" has been made.

### Note

#### Loss of Information

Ensure that Data Matrix codes are not positioned over one another at a branch, as otherwise data may be lost.

Control codes can be mounted in the immediate vicinity of a branch with Data Matrix codes for positioning, but not near an intersection. The control code must be mounted directly next to the guiding lane.

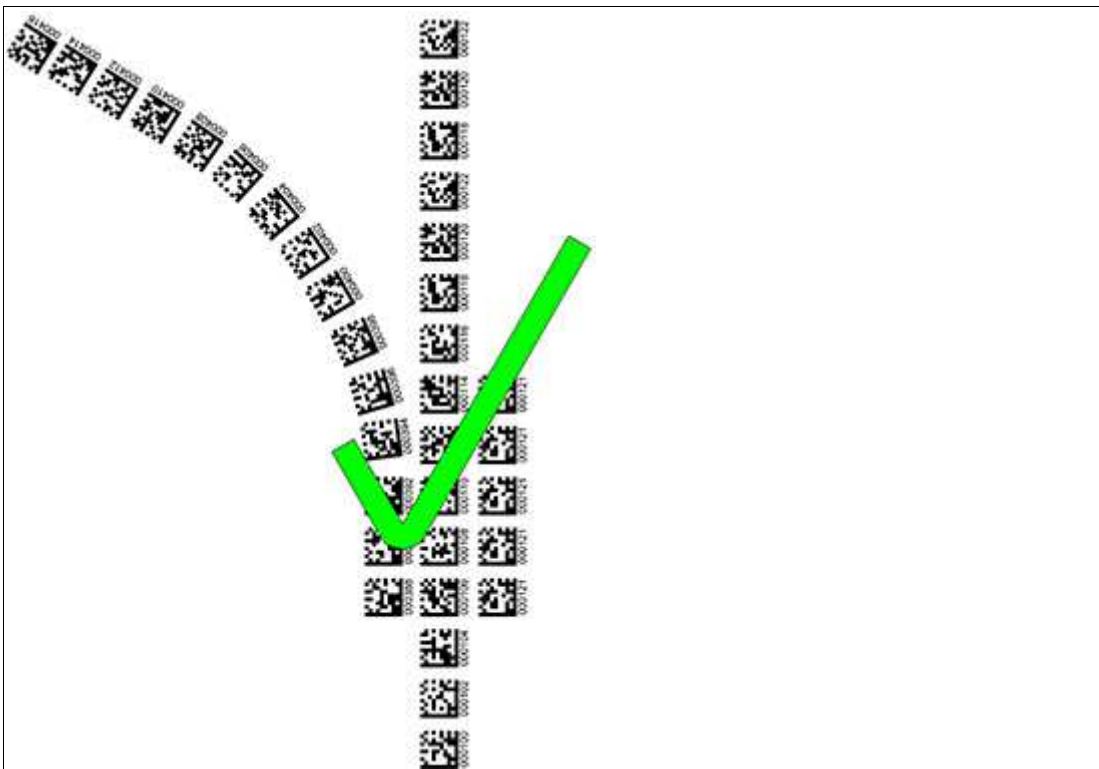

Figure 3.7 Branch with control code

### Note

#### End of the selected lane

If the currently selected lane ends and there is a second lane in the field of view, the read head will automatically follow the second lane.



### Distances

To ensure that the read head can clearly detect and assign Data Matrix codes, minimum and maximum distances must be observed when creating the lanes.

Offset  $V$  between position codes of a lane must not be greater than 5 mm.



Figure 3.8 Offset:  $0\text{ mm} \leq V \leq 5\text{ mm}$

The distance between the Data Matrix code tapes at a branch or intersection as a separate lane must be between 0 mm and 5 mm.

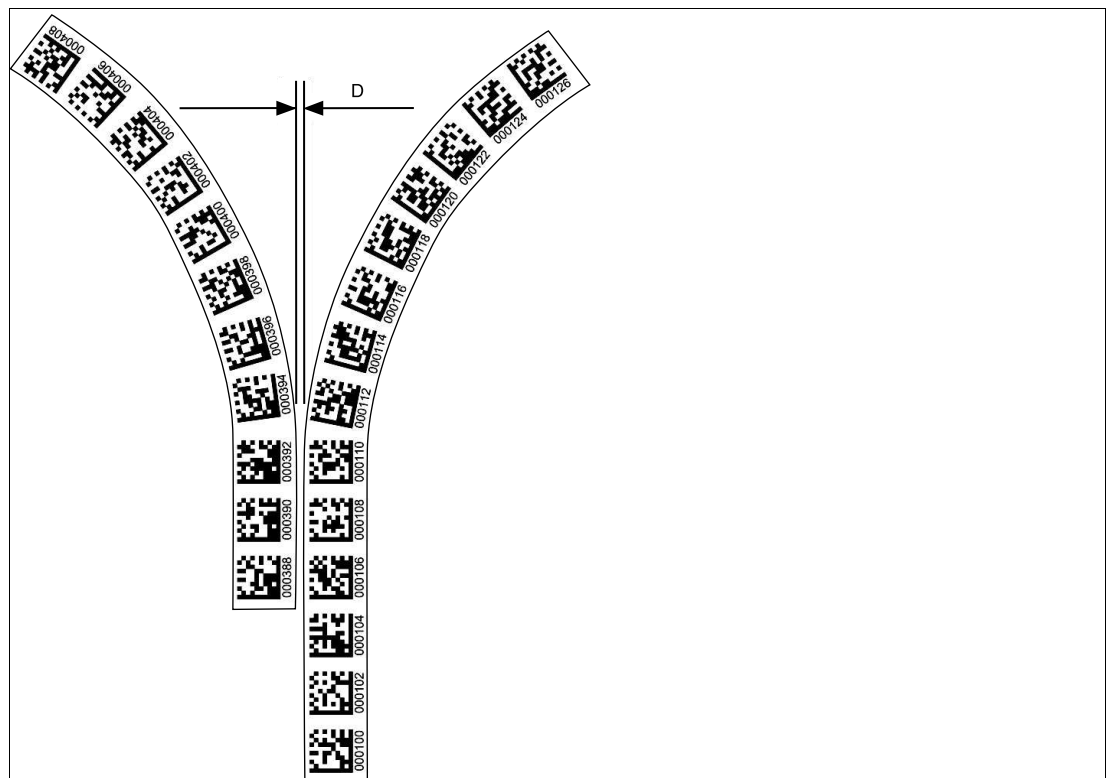

Figure 3.9 Distance:  $0\text{ mm} \leq D \leq 5\text{ mm}$

The distance between a Data Matrix position code and a Data Matrix control code must be between 0 mm and 5 mm.

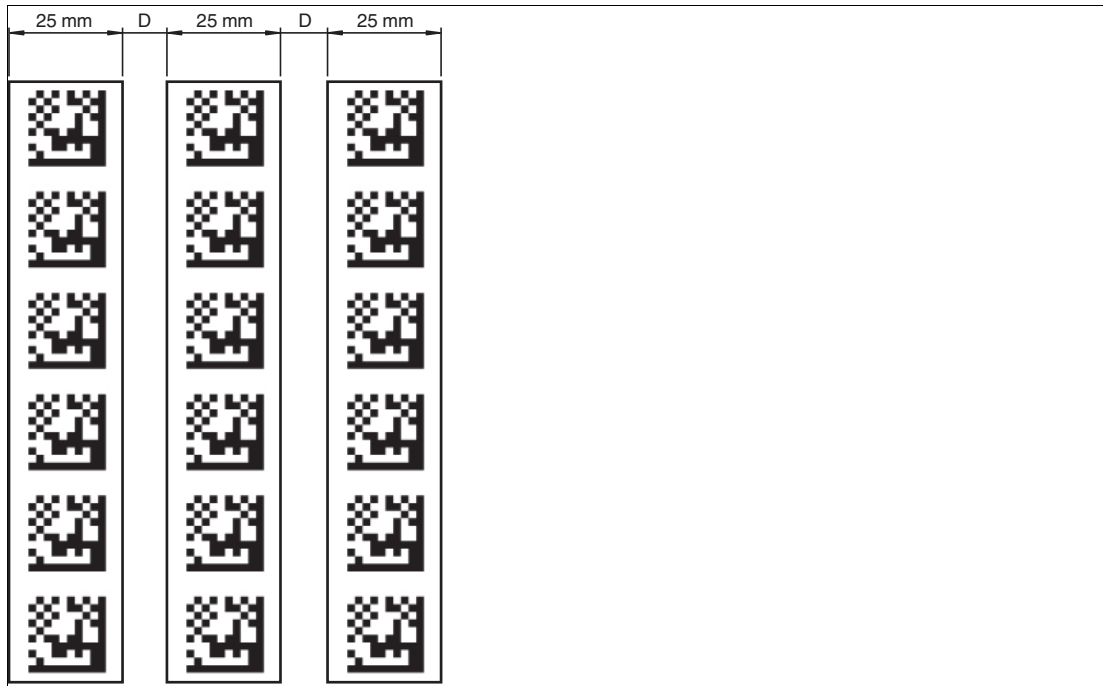

Figure 3.10  $0 \text{ mm} \leq D \leq 5 \text{ mm}$

### Data Matrix Tag (8 digit number)

A Data Matrix tag contains position information and a specific 8 digit number. A cross in the center of the Data Matrix tag marks the zero point. The X and the Y axes are marked starting from the zero point. The black arrow indicates the positive axis and the white arrow indicates the negative axis.



**Note**

Depending on the material used, the dimensions may be different. Please refer to the respective data sheets of the DataMatrix tags.

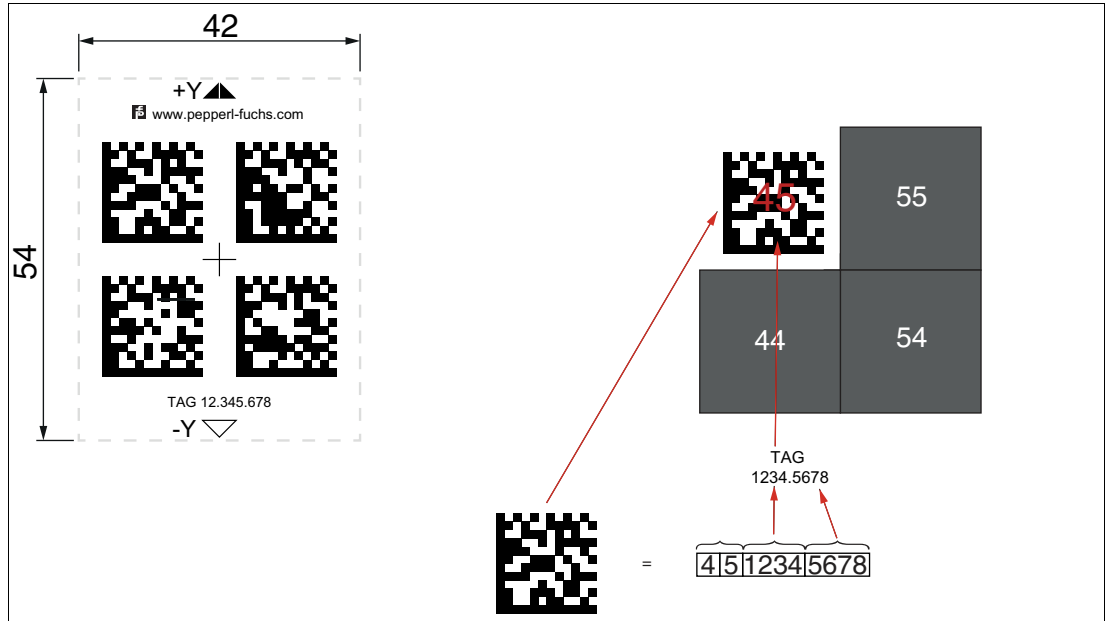

Figure 3.11 2x2 Data Matrix tag with the number 123456789 and position information

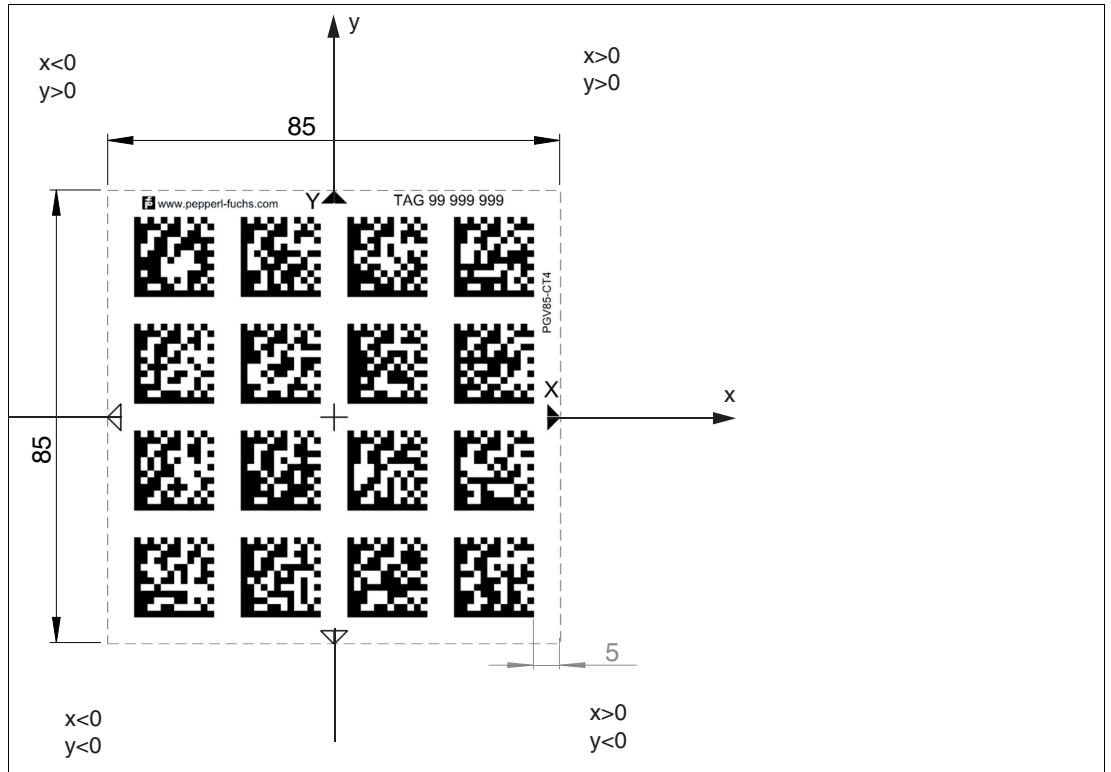

Figure 3.12 4x4 Data Matrix tag with the number 99999999 and position information

2021-05

### Data Matrix Tag — Extended (14 digit number)

A Data Matrix tag contains position information and a specific 14 digit number. A cross in the center of the Data Matrix tag marks the zero point. The X and the Y axes are marked starting from the zero point. The black arrow indicates the positive axis and the white arrow indicates the negative axis.



**Note**

Depending on the material used, the dimensions may be different. Please refer to the respective data sheets of the DataMatrix tags.

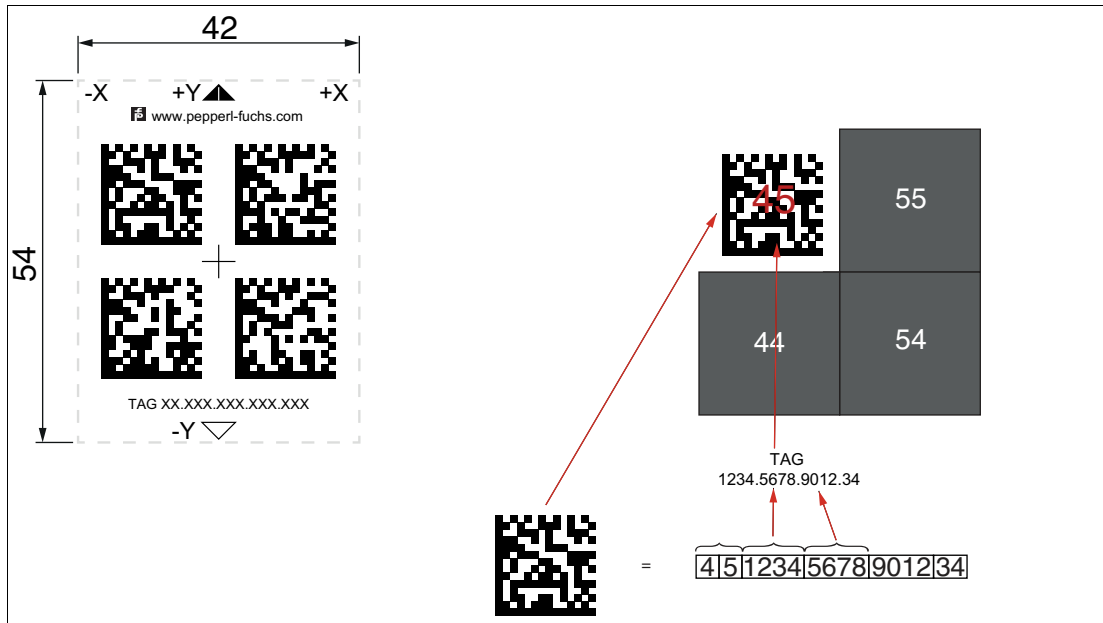

Figure 3.13 2x2 Data Matrix tag with number 12345678901234 and position information

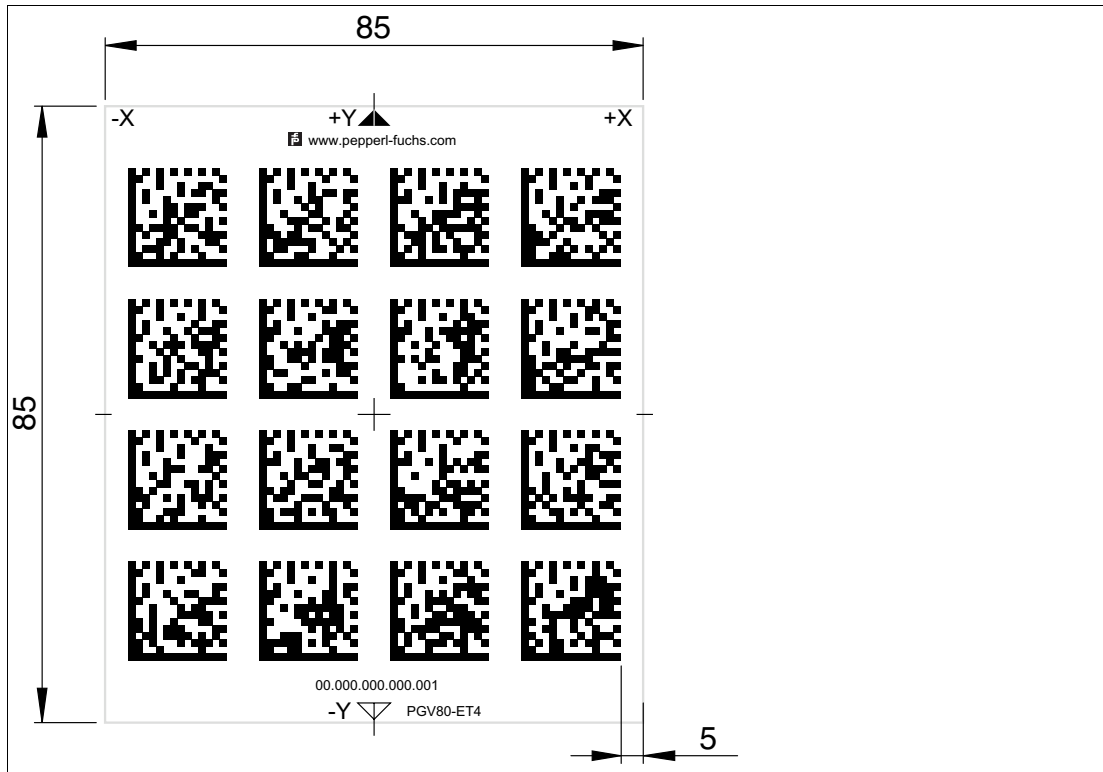

Figure 3.14 4x4 DataMatrix tag with the number 00000000000001 and position information

2021-05

### 3.3 Electrical Connection

The read head is connected electrically via a fixed cable with open cores on the side of the housing. The power is supplied via this connection. The configurable inputs and outputs on the read head are also located at this connection.

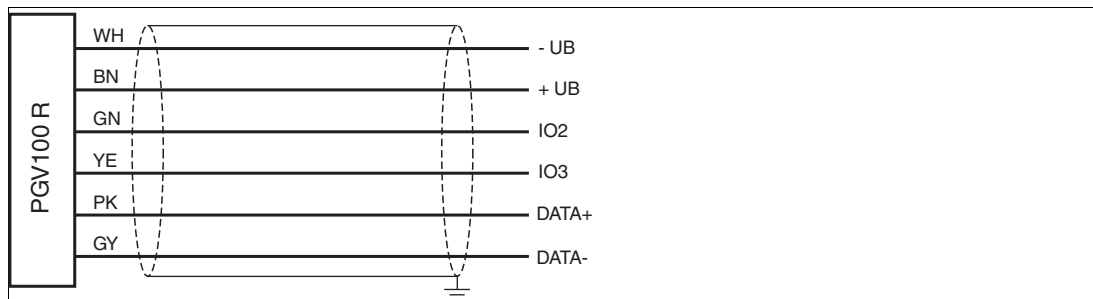

Figure 3.15 Electrical connection

#### Color Assignment

Strand color	Color abbreviation
White	WH
Brown	BN
Green	GN
Yellow	YE
Pink	PK
Gray	GY

Table 3.3 Color assignment

#### Shielding Cables

The shielding of connection lines is required to suppress electromagnetic interference. Establishing a low resistance or low impedance connection with the protective conductor or equipotential bonding circuit is a particularly important factor in ensuring that these interference currents do not become a source of interference themselves. The shield of the connection cable of the read head must be connected to the equipotential bonding on the control cabinet side.

The following points relating to shielding must be noted:

- Use metal cable clips that cover large areas of the shielding.
- Place the cable shield onto the equipotential bonding rail immediately on entering the switch cabinet.
- Direct the protective grounding connections to a common point in a star configuration.
- The cross-section of the cables used for grounding should be as large as possible.



#### Caution!

Damage to the device

Connecting an alternating current or excessive supply voltage can damage the device or cause the device to malfunction.

Electrical connections with reversed polarity can damage the device or cause the device to malfunction.

Connect the device to direct current (DC). Ensure that the supply voltage rating is within the specified device range. Ensure that the connecting wires on the female cordset are connected correctly.

## 4 Commissioning

### 4.1 Direction Decision

The read head requires a specification of the lane to be selected for the output of position information. In general, lane selection is possible via the IOs of the read head and via the request telegram. For lane selection via the IOs of the read head, these must be configured accordingly. If the IOs of the read head are configured as inputs for direction decision, a direction decision via the request telegram is still possible. After the direction decision has been made via the request telegram, the IOs are always deactivated until the sensor is restarted.

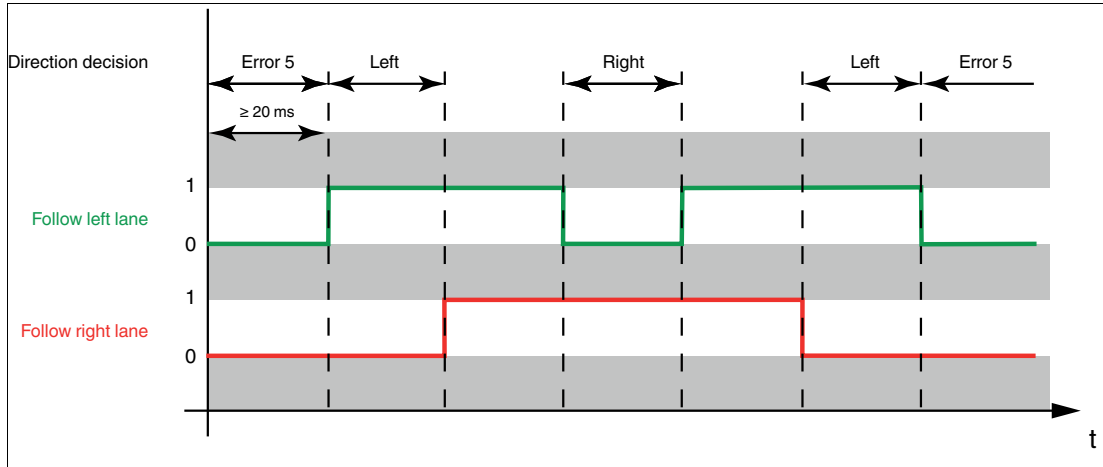

Figure 4.1 Direction decision

## 4.2 Parameterization Using Code Cards

During parameterization, the read head scans special code cards optically and configures the relevant parameters. Simply hold the corresponding code cards at the correct distance in front of the lens on the read head. The standard code cards are in the appendix.



### Note

Parameterization mode can be activated in the first five minutes after voltage connection. A time lock disables the read head once this time has elapsed. If parameterization is required at a later time, switch off the supply voltage to the read head and switch it back on again. Parameterization mode can now be activated within the first five minutes. The time lock remains inactive during the parameterization process.



### Activating Parameterization Mode

1. To activate the read head, hold the "**ACTIVATE**" code card in the field of view of the read head's camera system.



### Note

The second parameterization code "USER" can be activated within the first **two minutes** after the first parameterization code "ACTIVATE" has been detected.

↳ After recognition of the parameterization code, the activation of the parameterization mode is enabled by the code card "USER". The read head can still be accessed by the controller.

2. To activate the read head, hold the "**USER**" code card in the field of view of the read head's camera system.

↳ Once the parameterization code has been detected, LED2 lights up green for 1 second. The read head is now in parameterization mode.



### Completing Parameterization

Place the parameterization code in the field of view of the camera module.

↳ Once the parameterization code has been detected, LED2 lights up green for 1 second. If the parameterization code is invalid, LED2 lights up red for 1 second.



### Finish Parameterization And Save Parameters

Now hold the "**STORE**" code in front of the read head's camera system to save the configuration.

↳ When the "**STORE**" memory code is detected, the LED2 lights up green for 1 second. The parameterization is stored in the non-volatile memory of the read head and parameterization mode is terminated. Parameterization of the read head is now complete. If the memory code is not detected, LED2 lights up red for 1 second.

### 4.2.1 The code cards "CANCEL", "USE", and "DEFAULT"

Holding one of these cards in front of the reading head exits parameterization mode with the following consequences:

- **CANCEL:**  
All parameter changes that are made but have not yet been saved are discarded. The reading head operates with the last valid parameters that were saved.
- **USE:**  
For test purposes, the reading head operates with the parameters that have just been modified. The parameterization is not saved, however. After being switched off and on again, the reading head operates with the last valid parameters that were saved.
- **DEFAULT:**  
All parameters in the reading head are overwritten with the original default settings. Re-enter the configuration mode and save the default settings nonvolatile with the code card STORE.



## 5 Operation and communication

### 5.1 Communication via the RS-485 Interface

The controller and read head communicate via the RS-485 interface during operation. Make sure that the basic communication settings have been made on the read head, such as setting the read head address and baud rate.

A distinction is made between request telegrams that the controller sends to the read head and response telegrams that the read head sends to the controller. Each byte of a request or response telegram consists of 9 bits (8 data bits + 1 parity bit).

#### 5.1.1 Request Telegram

A request telegram always consists of 2 bytes. The second byte corresponds to the first byte, but with the 8 data bits of the first byte inverted.

##### Structure of a Request Telegram

Byte/ bit	Bit 8	Bit 7	Bit 6	Bit 5	Bit 4	Bit 3	Bit 2	Bit 1	Bit 0	Function
Byte 1	Parity	1 <sup>1</sup>	Req. bit 4	Req. bit 3	Req. bit 2	Req. bit 1	Req. bit 0	A1	A0	Request
Byte 2	Parity	0	~Req. bit 4	~Req. bit 3	~Req. bit 2	~Req. bit 1	~Req. bit 0	~A1	~A0	Checksum

Table 5.1 Structure of a request telegram

1. R/W: 0 = response, 1 = request

##### Meaning of Bits

PAR	R/W	Req. bit 4	Req. bit 3	Req. bit 2	Req. bit 1	Req. bit 0	A1	A0	Function
Parity	1	x	x	x	x	x	0	0	Read head address 0
Parity	1	x	x	x	x	x	0	1	Read head address 1
Parity	1	x	x	x	x	x	1	0	Read head address 2
Parity	1	x	x	x	x	x	1	1	Read head address 3
Parity	1	1	0	0	1	0	x	x	Position inquiry (see chapter 5.1.2)
Parity	1	1	1	0	LT	RT	x	x	Selection of direction ( )

Table 5.2 Meaning of bits

## 5.1.2 Position Response Telegram

A response telegram is 21 bytes long. Bytes 1 and 2 contain the read head address and status information.

### Response telegram from the read head — lane tracking

	Bit 8	Bit 7	Bit 6	Bit 5	Bit 4	Bit 3	Bit 2	Bit 1	Bit 0
Byte 1	Parity	0	CC2	A1	A0	CC1	WRN	NP	ERR
Byte 2	Parity	0	TAG [0] <sup>1</sup>	0	0	0	1	LT	RT
Byte 3	Parity	0	Reserved	Reserved	Reserved	Reserved	XPR23	XPR22	XPR21
Byte 4	Parity	0	XPR20	XPR19	XPR18	XPR17	XPR16	XPR15	XPR14
Byte 5	Parity	0	XPR13	XPR12	XPR11	XPR10	XPR09	XPR08	XPR07
Byte 6	Parity	0	XPR06	XPR05	XPR04	XPR03	XPR02	XPR01	XPR00
Byte 7	Parity	0	YPL13	YPL12	YPL11	YPL10	YPL09	YPL08	YPL07
Byte 8	Parity	0	YPL06	YPL05	YPL04	YPL03	YPL02	YPL01	YPL00
Byte 9	Parity	0	YPR_13	YPR_12	YPR_11	YPR_10	YPR_09	YPR_08	YPR_07
Byte 10	Parity	0	YPR_06	YPR_05	YPR_04	YPR_03	YPR_02	YPR_01	YPR_00
Byte 11	Parity	0	ANGL13	ANGL12	ANGL11	ANGL10	ANGL09	ANGL08	ANGL07
Byte 12	Parity	0	ANGL06	ANGL05	ANGL04	ANGL03	ANGL02	ANGL01	ANGL00
Byte 13	Parity	0	ANGL-R_13	ANGR_12	ANGR_11	ANGR_10	ANGR_09	ANGR_08	ANGR_07
Byte 14	Parity	0	ANGL-R_06	ANGR_05	ANGR_04	ANGR_03	ANGR_02	ANGR_01	ANGR_00
Byte 15	Parity	0	O1_1	O1_0	S1_1	S1_0	CC1_09	CC1_08	CC1_07
Byte 16	Parity	0	CC1_06	CC1_05	CC1_04	CC1_03	CC1_02	CC1_01	CC1_00
Byte 17	Parity	0	O2_1	O2_0	S2_1	S2_0	CC2_09	CC2_08	CC2_07
Byte 18	Parity	0	CC2_06	CC2_05	CC2_04	CC2_03	CC2_02	CC2_01	CC2_00
Byte 19	Parity	0	WRN13	WRN12	WRN11	WRN10	WRN09	WRN08	WRN07
Byte 20	Parity	0	WRN06	WRN05	WRN04	WRN03	WRN02	WRN01	WRN00
Byte 21	Parity	0	XOR B1.6 ... B20.6	XOR B1.5 ... B20.5	XOR B1.4 ... B20.4	XOR B1.3 ... B20.3	XOR B1.2 ... B20.2	XOR B1.1 ... B20.1	XOR B1.0 ... B20.0

Table 5.3 Response telegram from the read head — lane tracking

1. If bit = 0: read head follows the lane tape

**Response telegram from the read head — Data Matrix tag**

	Bit 8	Bit 7	Bit 6	Bit 5	Bit 4	Bit 3	Bit 2	Bit 1	Bit 0
Byte 1	Parity	0	CC2	A1	A0	CC1	WRN	NP	ERR
Byte 2	Parity	0	TAG [1] <sup>1</sup>	0	0	0	1	LT	RT
Byte 3	Parity	0	Reserved	Reserved	Reserved	Reserved	XPL23	XPL22	XPL21
Byte 4	Parity	0	XPL20	XPL19	XPL18	XPL17	XPL16	XPL15	XPL14
Byte 5	Parity	0	XPL13	XPL12	XPL11	XPL10	XPL09	XPL08	XPL07
Byte 6	Parity	0	XPL06	XPL05	XPL04	XPL03	XPL02	XPL01	XPL00
Byte 7	Parity	0	YPL13	YPL12	YPL11	YPL10	YPL09	YPL08	YPL07
Byte 8	Parity	0	YPL06	YPL05	YPL04	YPL03	YPL02	YPL01	YPL00
Byte 9	Parity	0	TAG_55	TAG_54	TAG_53	TAG_52	TAG_51	TAG_50	TAG_49
Byte 10	Parity	0	TAG_48	TAG_47	TAG_46	TAG_45	TAG_44	TAG_43	TAG_42
Byte 11	Parity	0	ANGL13	ANGL12	ANGL11	ANGL10	ANGL09	ANGL08	ANGL07
Byte 12	Parity	0	ANGL06	ANGL05	ANGL04	ANGL03	ANGL02	ANGL01	ANGL00
Byte 13	Parity	0	TAG_41	TAG_40	TAG_39	TAG_38	TAG_37	TAG_36	TAG_35
Byte 14	Parity	0	TAG_34	TAG_33	TAG_32	TAG_31	TAG_30	TAG_29	TAG_28
Byte 15	Parity	0	TAG_27	TAG_26	TAG_25	TAG_24	TAG_23	TAG_22	TAG_21
Byte 16	Parity	0	TAG_20	TAG_19	TAG_18	TAG_17	TAG_16	TAG_15	TAG_14
Byte 17	Parity	0	TAG_13	TAG_12	TAG_11	TAG_10	TAG_09	TAG_08	TAG_07
Byte 18	Parity	0	TAG_06	TAG_05	TAG_04	TAG_03	TAG_02	TAG_01	TAG_00
Byte 19	Parity	0	WRN13	WRN12	WRN11	WRN10	WRN09	WRN08	WRN07
Byte 20	Parity	0	WRN06	WRN05	WRN04	WRN03	WRN02	WRN01	WRN00
Byte 21	Parity	0	XOR B1.6 ... B20.6	XOR B1.5 ... B20.5	XOR B1.4 ... B20.4	XOR B1.3 ... B20.3	XOR B1.2 ... B20.2	XOR B1.1 ... B20.1	XOR B1.0 ... B20.0

Table 5.4 Response telegram from the read head — Data Matrix tag

1. If bit = 1: read head detects Data Matrix tag

Designation	Function
A	Address of the read head
ANGL	Absolute angle of the left lane
ANGR	Absolute angle of the right lane
CC1_#/CC2_#	Control code 1 or 2 with number # detected Control code 2 is evaluated via the "Split value" function. <sup>1</sup>
CC1/CC2	Associated control code is detected.
ERR	Error message Error codes are stored in XP00 ... XP23. Additional information on the codes can be found in the <b>Error Codes</b> table.
LT/RT	Selected direction decision
NP	No absolute X position
O1_#/O2_#	Orientation control code for lane. .
S1_#/S2_#	Relative position control code for lane. .
TAG	Data Matrix tag detected
TAG_#	Data Matrix tag with number # detected
WRN	Warning message Warnings are stored in WRN00 ... WRN13. Additional information on the codes can be found in the <b>Warning Messages</b> table.
XPL	X position of left lane
XPR	X position of right lane
YPL	Y position of left lane
YPR	Y position of right lane

Table 5.5 Functional description of the bits

1. Should you have any questions, please contact Pepperl+Fuchs

### Error Codes

Error code	Description	Priority
2	No clear position can be determined, e.g., difference between codes is too great, code distance incorrect	4
5	No direction decision available,	2
6	Internal	3
> 1000	Internal error	1

Table 5.6 Error Codes

**Warning Messages**

Warning message	Description
WRN00	Code with content not typical of PGV found
WRN01	Read head too close to code tape
WRN02	Read head too far from code tape
WRN03	Reserved
WRN04	Reserved
WRN05	The read head is rotated or tipped in relation to the code tape
WRN06	Low level of code contrast
WRN07	Reserved
WRN08	Temperature too high
WRN09	Position code near branch/crossover detected
WRN10	More than the specified number of code lanes present
WRN11	Selected lane not visible. The position data originates from another lane in the field of view.
WRN12	Reserved
WRN13	Reserved

Table 5.7 If no warnings are present, the bits are set to 0.

### 5.1.2.1 Orientation O

The orientation O indicates the orientation of the Data Matrix control codes (see chapter 5.2) in the reading window. See "Orientation and Side" on page 31.

#### Meaning of Bits

Bit1=O1	Bit0=O0	Meaning
0	0	Data Matrix Control code has the same orientation as ascending Data Matrix position code.
0	1	Orientation of Data Matrix control code rotated 90° clockwise in relation to ascending Data Matrix position code.
1	0	Orientation of Data Matrix control code rotated 180° clockwise in relation to ascending Data Matrix position code.
1	1	Orientation of Data Matrix control code rotated 270° clockwise in relation to ascending Data Matrix position code.

### 5.1.2.2 Side S

Side S specifies the side of the Data Matrix lane on which the Data Matrix control codes are present. See "Orientation and Side" on page 31.

#### Meaning of Bits

Bit1=S1	Bit0=S0	Meaning
0	0	No Data Matrix control code is present or found Reserved
0	1	Data Matrix Control code to the right of the Data Matrix lane
1	0	Data Matrix Control code to the left of the Data Matrix lane
1	1	Not detectable <sup>1</sup>

Table 5.8 Meaning of bits S1 and S0

1. Data Matrix Control code laid on Data Matrix lane  
No Data Matrix lane available



**Example**  
**Orientation and Side**

	Bit1	Bit0
Orientation	1	0
Side	1	0

	Bit1	Bit0
Orientation	0	0
Side	0	1

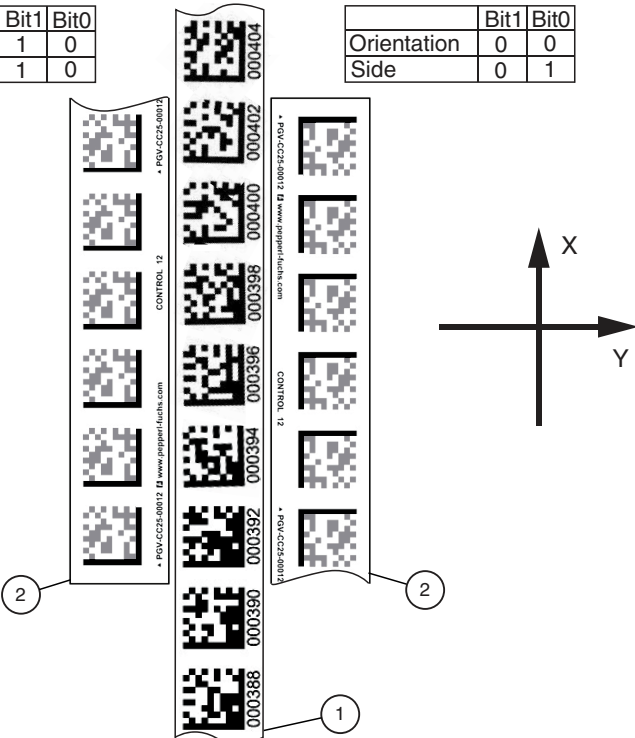

1. Data Matrix position code
2. Data Matrix control code

	Bit1	Bit0
Orientation	0	1
Side	1	0

	Bit1	Bit0
Orientation	1	1
Side	0	1

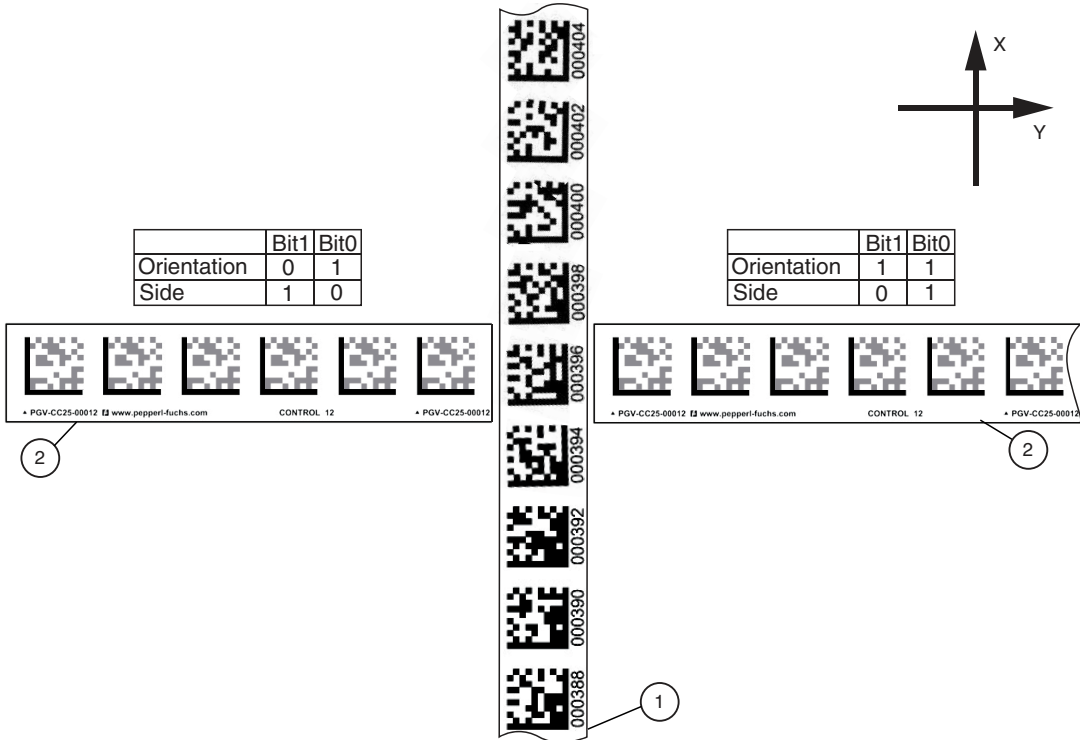

1. Data Matrix position code
2. Data Matrix control code

### 5.1.2.3 Position/Lane

You can use the following table to draw conclusions on the current section in the reading window based on the feedback from the read head regarding Data Matrix tag **TAG**, No X Position **NP**, absolute X position **XP** and the Y position and angle **YPS/ANG**.

#### Meaning of Bits

TAG	NP	XP	YPS/ANG	Meaning
0	0	+ <sup>1</sup>	+	Data Matrix lane available.
0	1	-	-	No evaluable objects exist.
1	0	+	+	Position on the basis of a Data Matrix tag, X position is signed.

Table 5.9 Meaning of bits

1. Valid data present

### 5.1.3 Direction Decision Request Telegram



#### Note

If direction decisions are made via the protocol, then subindex 12 "Input Source Selection" must be switched to Software in the global primary data.

Byte/bit	Bit 8	Bit 7	Bit 6	Bit 5	Bit 4	Bit 3	Bit 2	Bit 1	Bit 0	Function
Byte 1	Parity	1	1	1	0	LL	RL	A1	A0	Request
Byte 2	Parity	0	0	0	1	~LL	~RL	~A1	~A0	Checksum

#### Response Telegram for Direction Decision

	Bit 8	Bit 7	Bit 6	Bit 5	Bit 4	Bit 3	Bit 2	Bit 1	Bit 0
Byte 1	Parity	0	CC2	A1	A0	CC1	WRN	NP	ERR
Byte 2	Parity	0	0	0	0	0	0	LL	RL
Byte 3	Parity	0	XOR B1.6 ... B2.6	XOR B1.5 ... B2.5	XOR B1.4 ... B2.4	XOR B1.3 ... B2.3	XOR B1.2 ... B2.2	XOR B1.1 ... B2.1	XOR B1.0 ... B2.0

#### Meaning of Bits

LL	RL	Meaning
0	0	Error code 5
0	1	Follow right-hand lane
1	0	Follow left-hand lane
1	1	Straight ahead

Table 5.10



#### Example

Request telegram when read head address = 0



Request	Response	Description	Example
0xE8, 0x17	See "Response Telegram for Direction Decision"	Follow left-hand lane	--"0x02"--
0xE4, 0x1B		Follow right-hand lane	--"0x01"--
0xEC, 0x13		Straight ahead	--"0x03"--
0xE0, 0x1F		No lane is selected Error code 5	--"0x00"--

## 5.2 Operation Using Control Codes

In numerous positioning system applications, defined processes (= event) must be started at specific positions. This means that the exact positions must be defined via code tapes for positioning.

If an event needs to start at a particular position or a direction decision needs to be made, a control code is mounted parallel to the actual lane.

Only a specific event and the associated process then have to be programmed into the plant control system. The position in which the corresponding control code is placed next to the code tape for positioning does not have to be determined until the point of final commissioning of the plant. Even if subsequent changes are made to the layout of a plant, the relevant control code is simply moved to the new position without the need for program modifications.

Control codes are code tapes measuring one meter in length. The control code has an encrypted number. Control codes have numbers ranging from 001 to 999.

When the read head enters the range of a control code, it sets the control code flag in its output data.

The 1-meter-long control code can be shortened. However, the minimum length should be 3 codes (60 mm). If the speed of the read head increases, a longer control code is required. If the read head travels at maximum speed, a full-length control code of 1 meter must be positioned next to the code tape for positioning.

The minimum length of a control code can be calculated according to the following formula depending on the travel speed and trigger period:

$$L_{\text{control code}} = 60 \text{ mm} + V_{\text{max}} [\text{m/s}] * T_{\text{Trigger period}} [\text{s}] * 2$$

The trigger period is 40 ms.



### Example

#### Example calculation

The minimum length of the control code at a speed of 3 m/s and a trigger period of 40 ms is:  
 $L_{\text{control code}} = 60 \text{ mm} + 3 \text{ m/s} * 40 \text{ ms} * 2 = 300 \text{ mm}$

Control codes are identified by the printed number, in this case "Control 12".

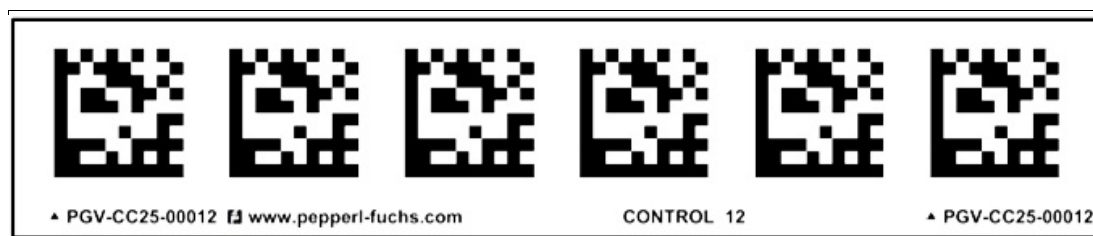

Figure 5.1 PGV-CC25-0012

The illustration shows part of control code #12

Refer to the "Accessories" chapter for ordering information relating to control codes.

### 5.3 Operation in case of repair

If repairs are required, the **Code Tape Generator** at [www.pepperl-fuchs.com](http://www.pepperl-fuchs.com) can be used as a short-term workaround. This generator enables segments of code tape to be produced and printed out online.

Enter the start value in meters and the code tape length of the section to be replaced in meters. This produces a printable PDF file containing the required segment of the code tape.

The printout must be used only as an emergency solution. The durability of the paper strip is extremely limited depending on the application!

### 5.4 Electrical switching output

The read head has two configurable switching outputs. The default setting is stored in the data sheet.

If the respective switching output is set to "sync-out", a synchronization pulse is provided at the switching output. The pulse is synchronized with the image acquisition. The control signal of the image acquisition (shutter time/flashduration) is provided latency-free at the output and extended to 1 ms pulse duration.

With the help of this synchronization pulse, the exact temporal assignment of the position data to the recording time can be realized.

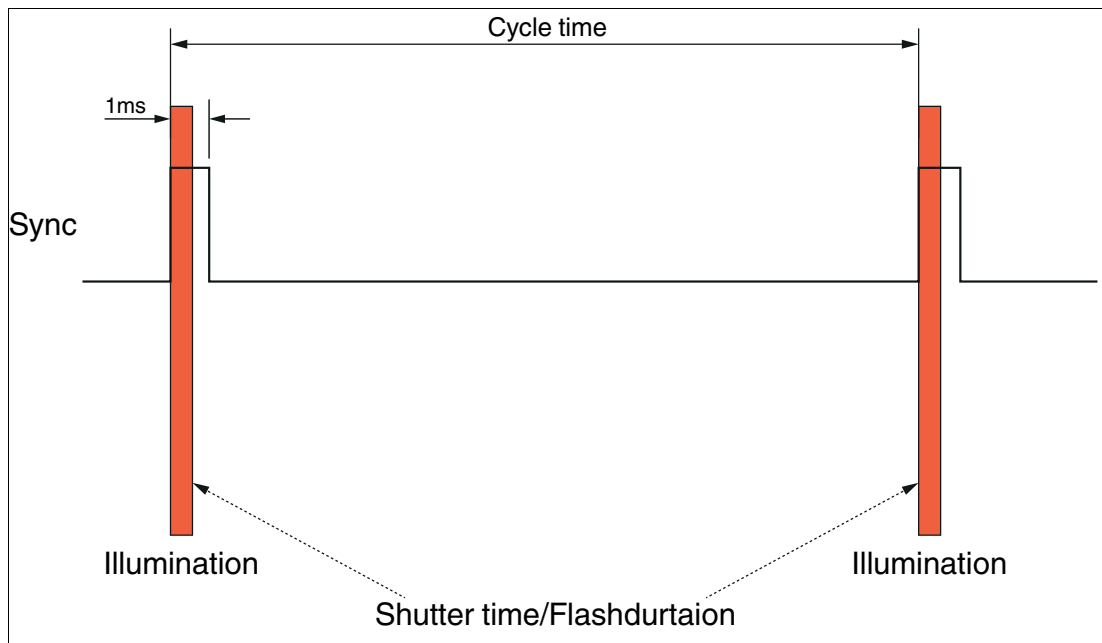

## 6 Appendix

### 6.1 Code Cards for External Parameterization

Here you will find the code cards that enable you to parameterize some of the basic functions of the read head in a step-by-step process. For the exact external parameterization procedure see chapter 4.2.



**Note**

When performing external parameterization with code cards, we recommend copying and printing out the relevant pages in this manual and cutting out the required code cards. This prevents the read head from mistakenly detecting another code card on the same page. If you intend to use this manual directly for parameterization, cover the code cards that you do not require with a sheet of paper, for example.

#### 6.1.1 Code Cards with Special Functions

The following code cards have special functions:

- ACTIVATE
- USER
- STORE
- CANCEL
- USE
- DEFAULT

**Activate**

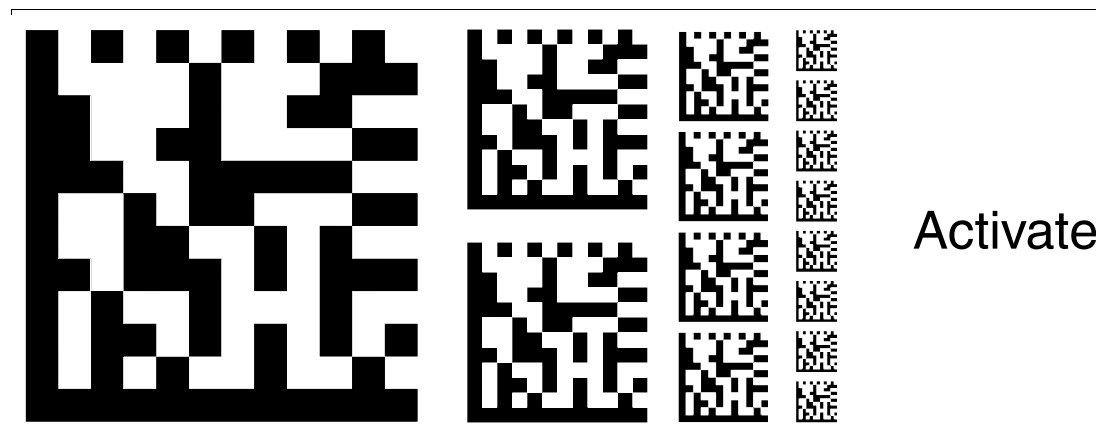

Figure 6.1 The "ACTIVATE" code card is used to activate external parameterization operating mode.

User

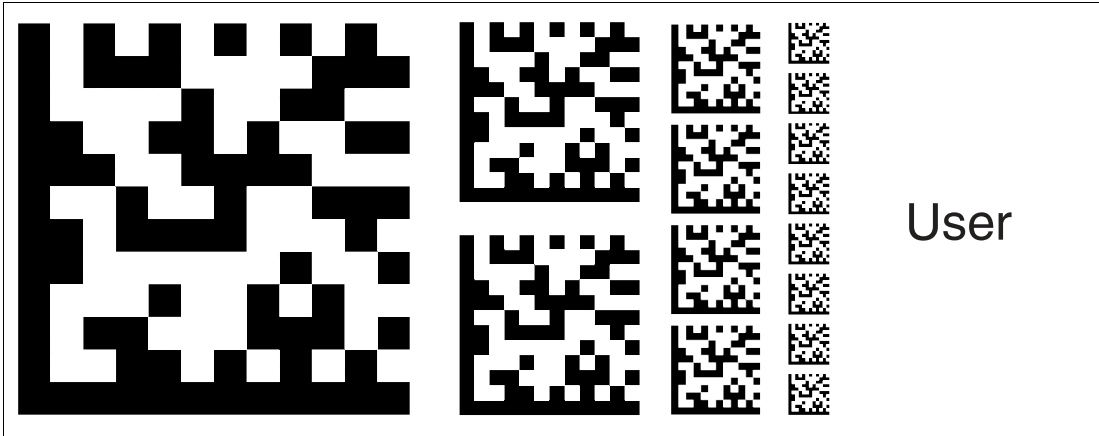

Figure 6.2 The "USER" code card is used to activate the user level in the external parameterization operating mode.

Store

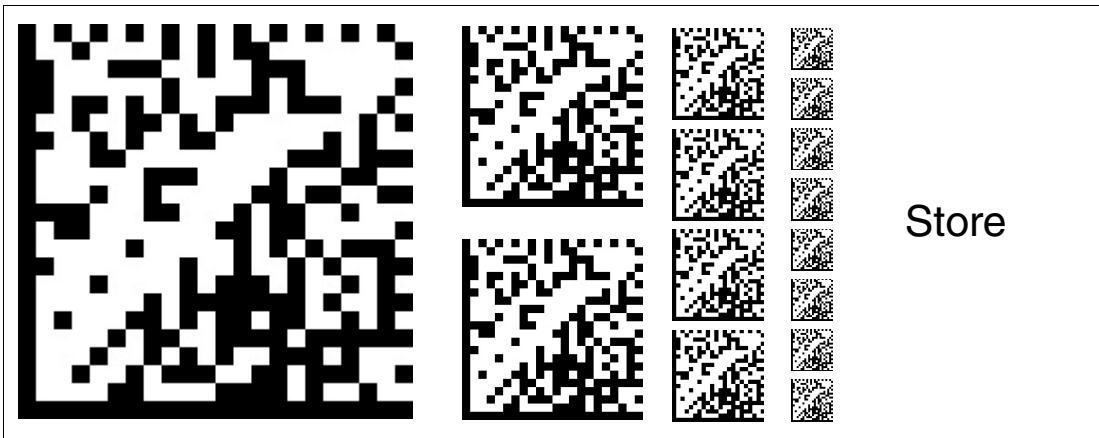

Figure 6.3 The "STORE" code card stores the modified parameterization in the nonvolatile memory of the read head and terminates external parameterization operating mode.

Cancel

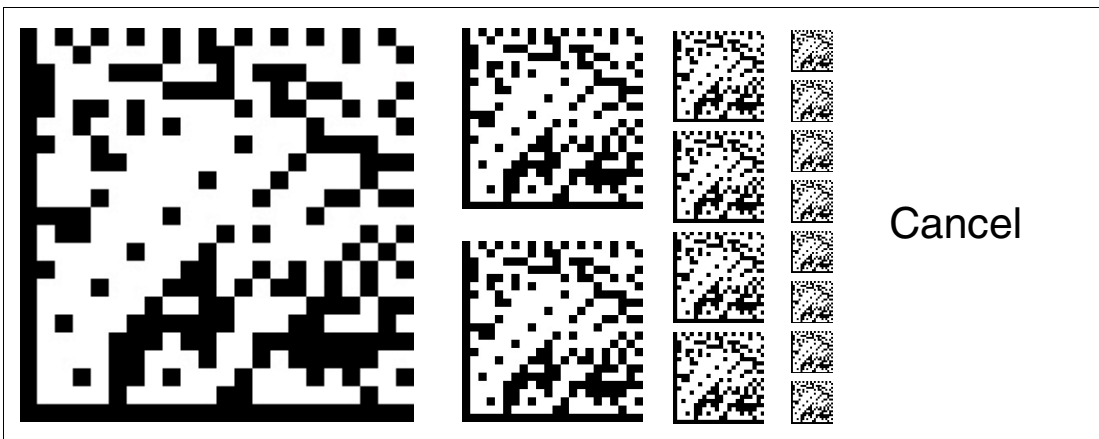

Figure 6.4 The "CANCEL" code card discards the modified parameterization and terminates external parameterization operating mode. The read head switches to normal mode and adopts the last valid configuration that was saved.

Use

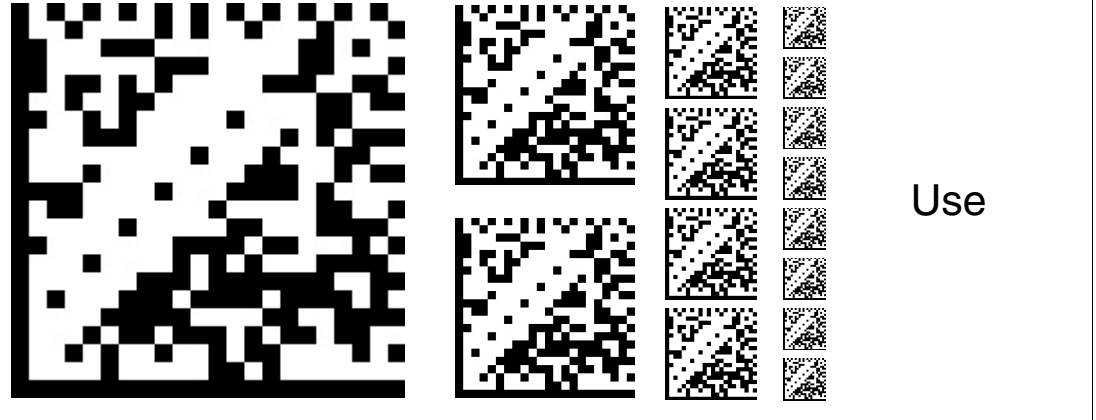

Figure 6.5 The "USE" code card takes over the set configuration **volatile** in the read head working memory and terminates the external parameterization operating mode. The read head then operates with this configuration. However, if the read head is switched off and on again, the configuration is lost and the read head operates with the last valid configuration that was saved. This function is used primarily for test purposes.

Default

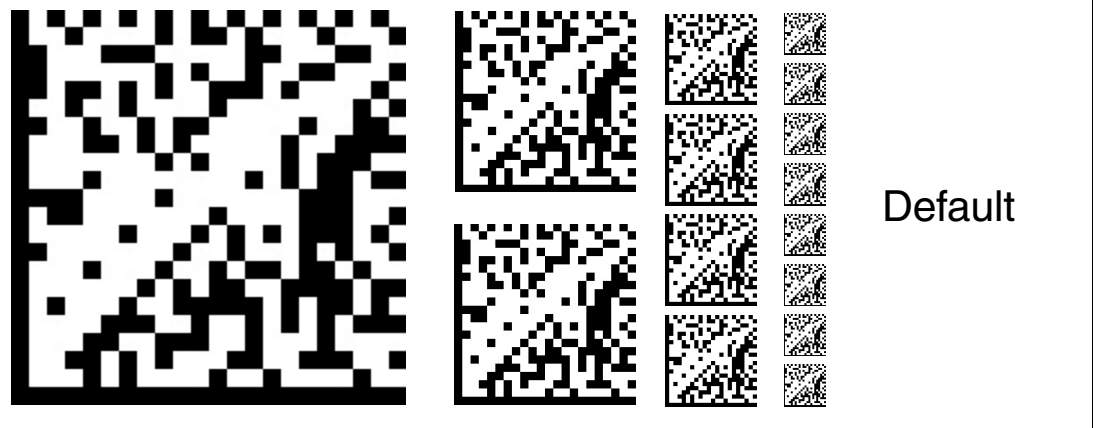

Figure 6.6 The "DEFAULT" code card restores the settings of the read head to default and terminates external parameterization operating mode.

## 6.1.2 Code Cards for Setting the Read Head Address

A unique address must be assigned to the read head so that it can be activated via the interface. The address range extends from 0 ... 3.

### Read Head Address 0

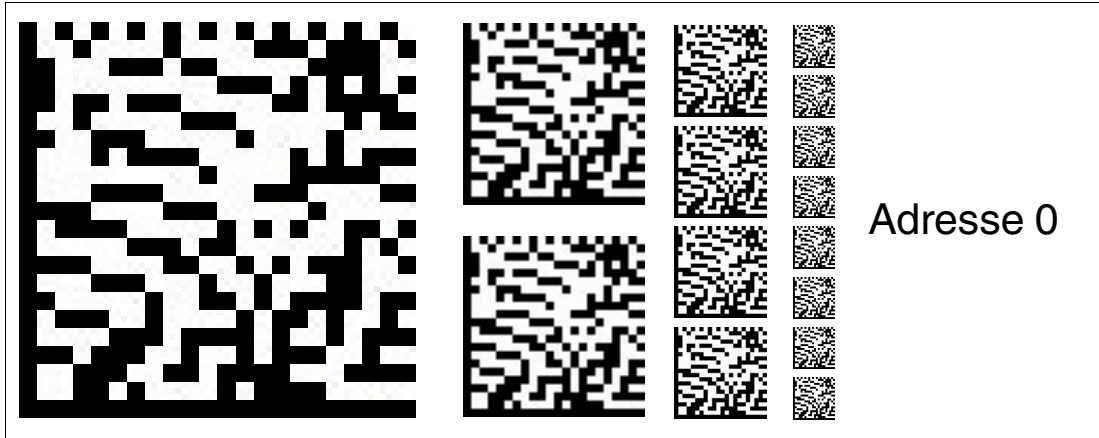

Figure 6.7 The code card assigns address 0 to the read head.

### Read Head Address 1

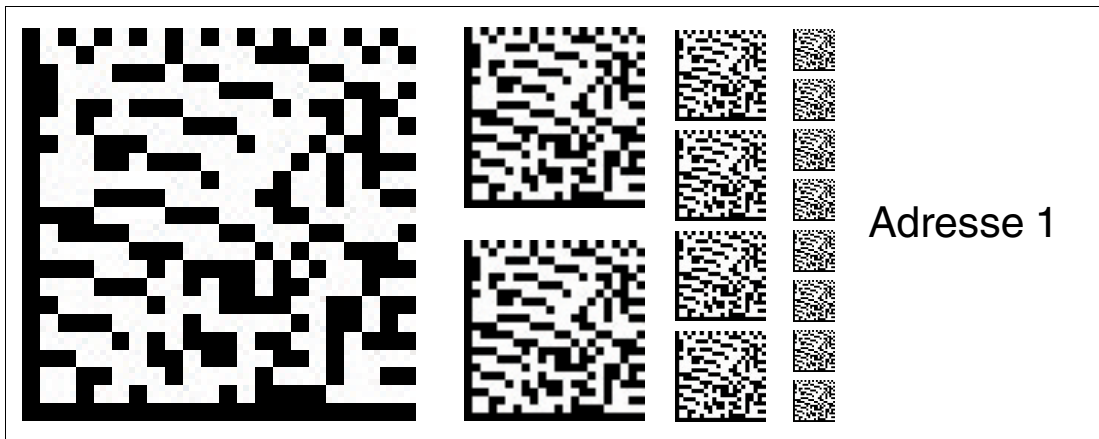

Figure 6.8 The code card assigns address 1 to the read head.

### Read Head Address 2

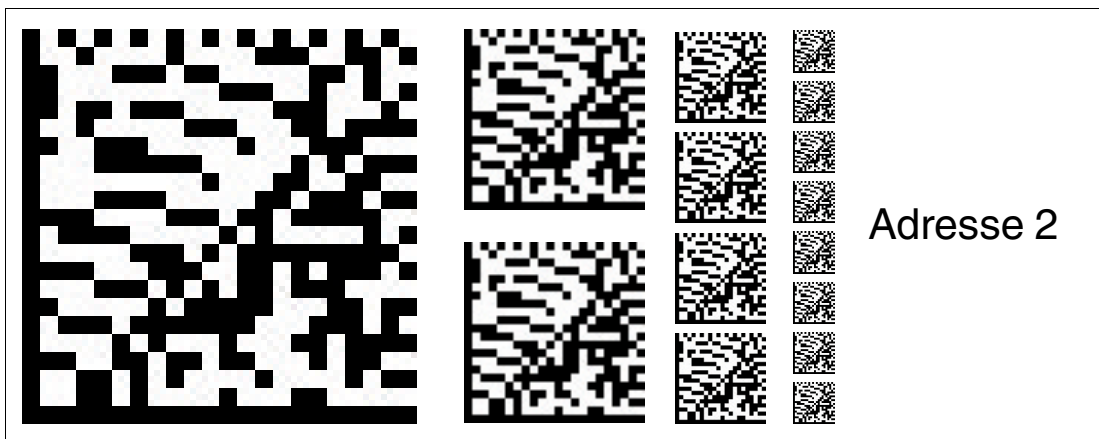

Figure 6.9 The code card assigns address 2 to the read head.

Read Head Address 3

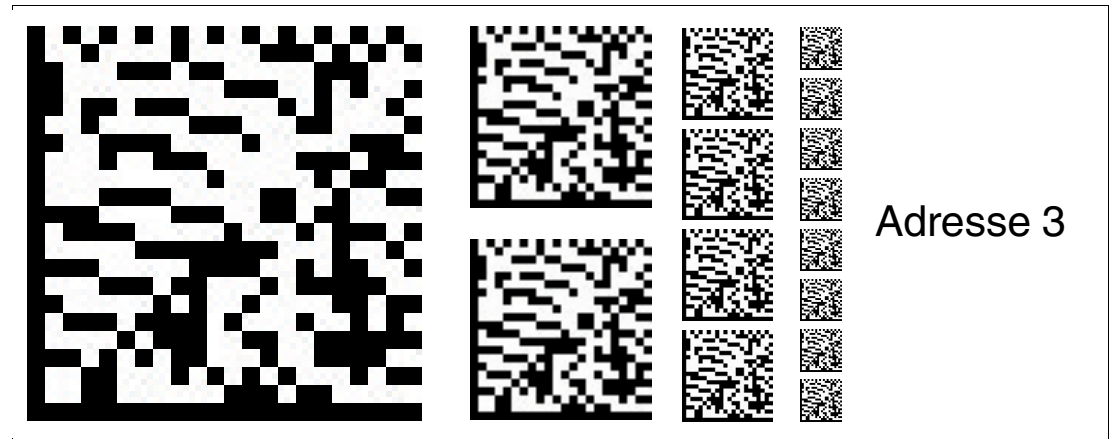

Figure 6.10 The code card assigns address 3 to the read head.

### 6.1.3 Code cards for setting the transfer rate

Parameterization allows you to assign various transfer rates to the reading head for communication via the interface. The following transfer rates are available:

- 38400 bit/s
- 57600 bit/s
- 76800 bit/s
- 115200 bit/s
- 230400 bit/s

#### Transfer rate: 38400 bit/s

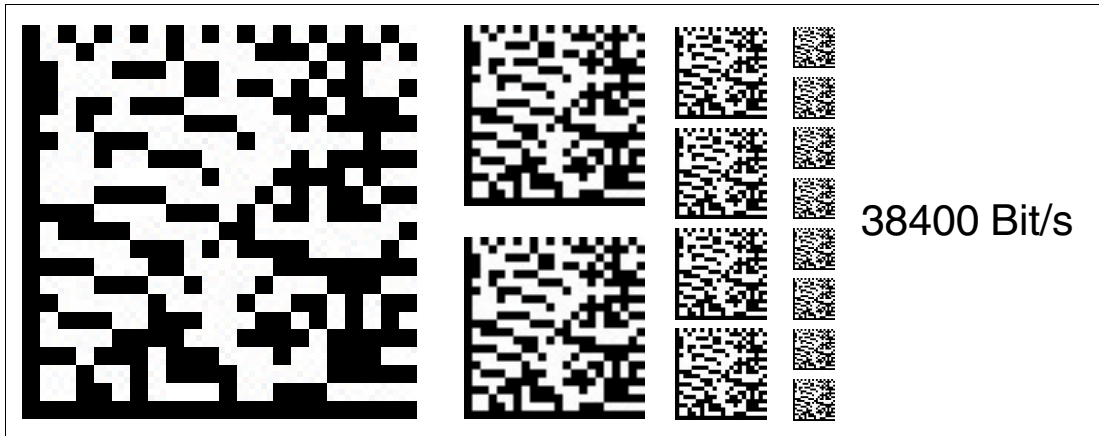

Figure 6.11 The transfer rate of the read head for communication via the interface is preset to 38400 bit/s.

#### Transfer rate: 57600 bit/s

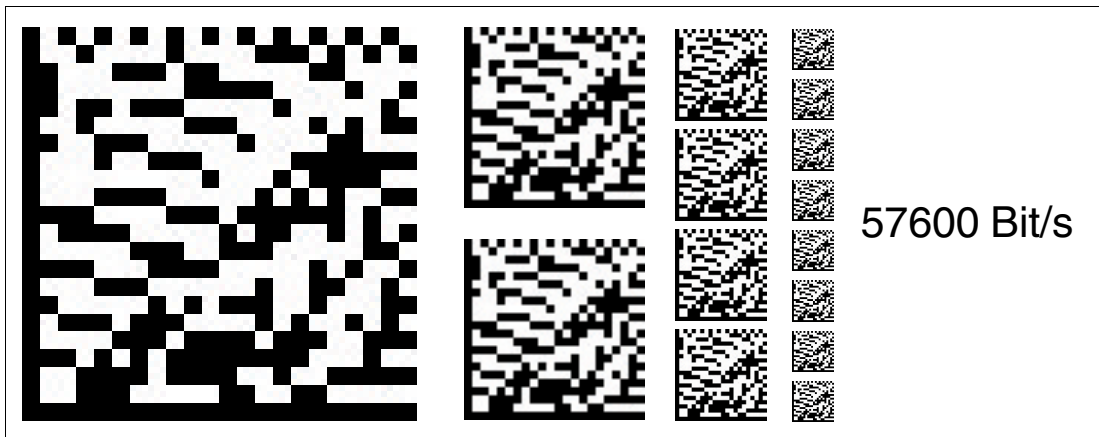

Figure 6.12 The transfer rate of the read head for communication via the interface is preset to 57600 bit/s.



**Transfer rate: 76800 bit/s**

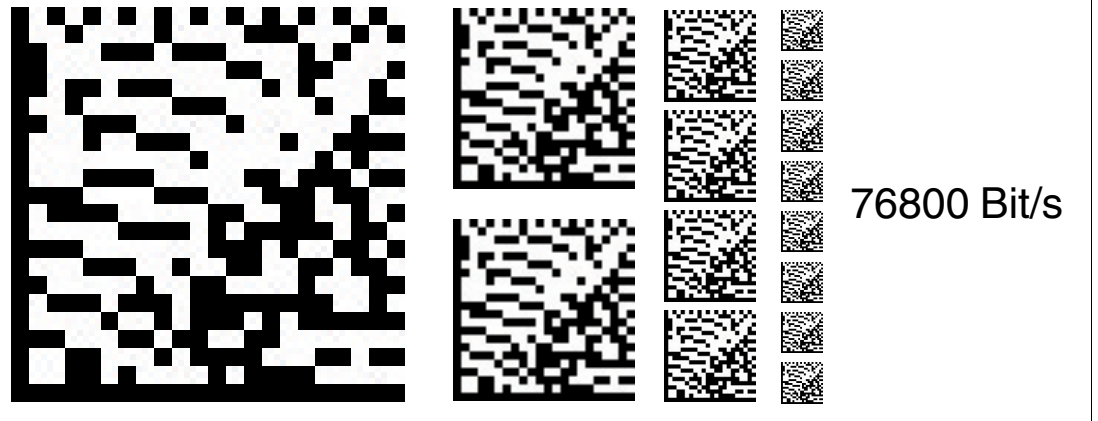

Figure 6.13 The transfer rate of the read head for communication via the interface is preset to 76800 bit/s.

**Transfer rate: 115200 bit/s**

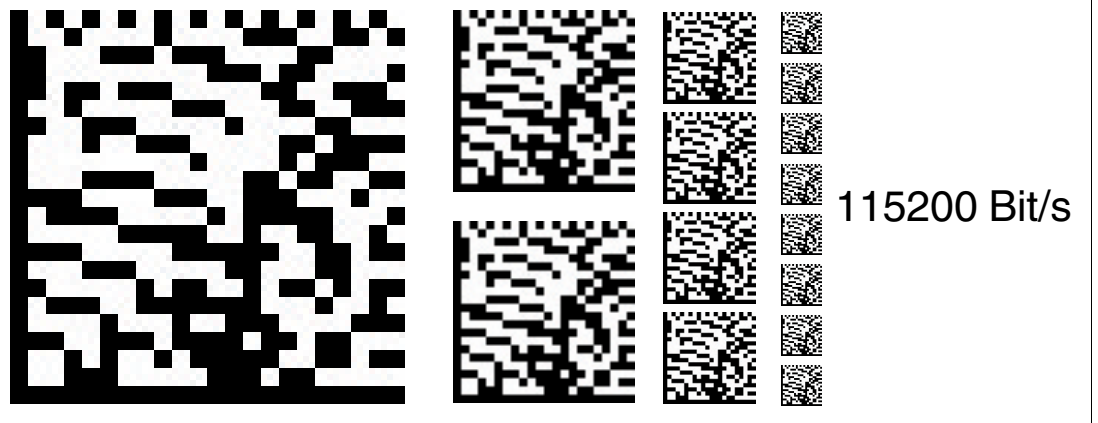

Figure 6.14 The transfer rate of the read head for communication via the interface is preset to 115200 bit/s.

**Transfer rate: 230400 bit/s**

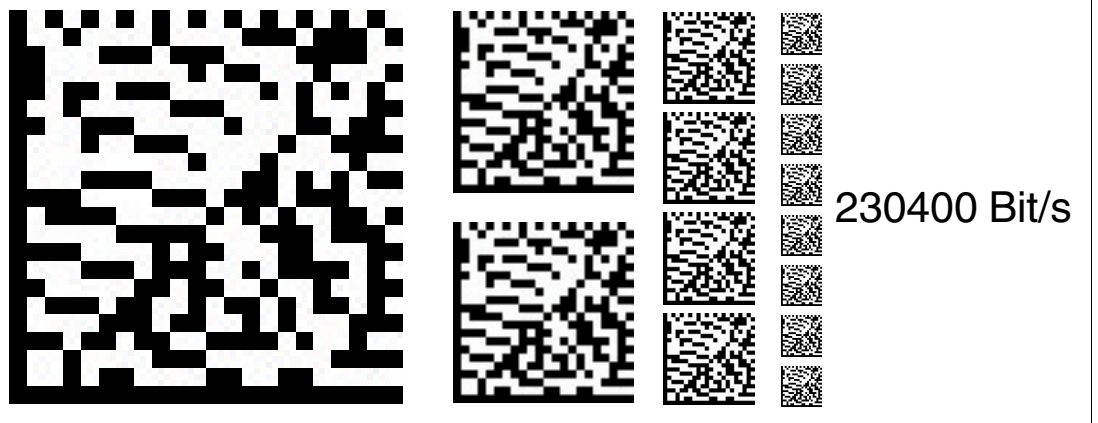

Figure 6.15 The transfer rate of the read head for communication via the interface is preset to 230400 bit/s.

### 6.1.4 Code Cards for Adjusting the Resolution

Parameterization enables you to assign a position data resolution of 0.1 mm / 1 mm / 10 mm to the read head.

#### Resolution: 0.1 mm

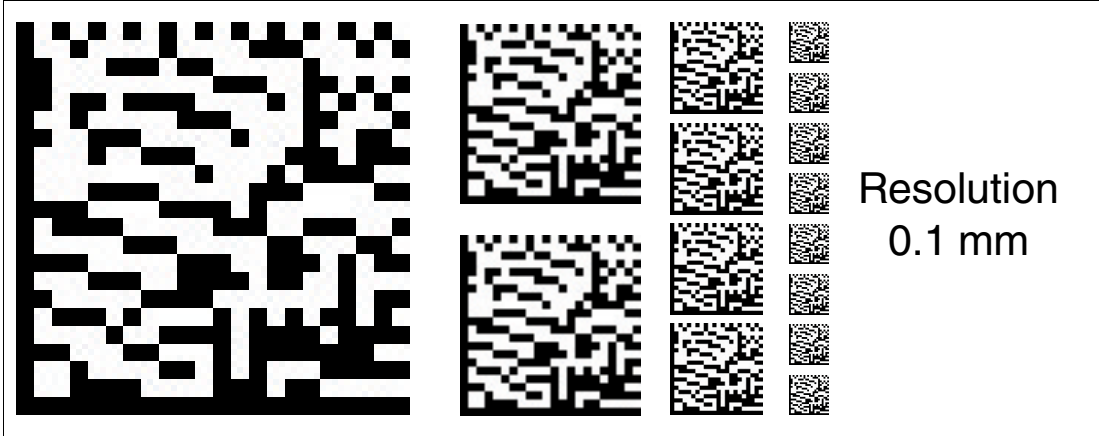

Figure 6.16 The code card assigns a position data resolution of 0.1 mm to the read head.

#### Resolution: 1 mm

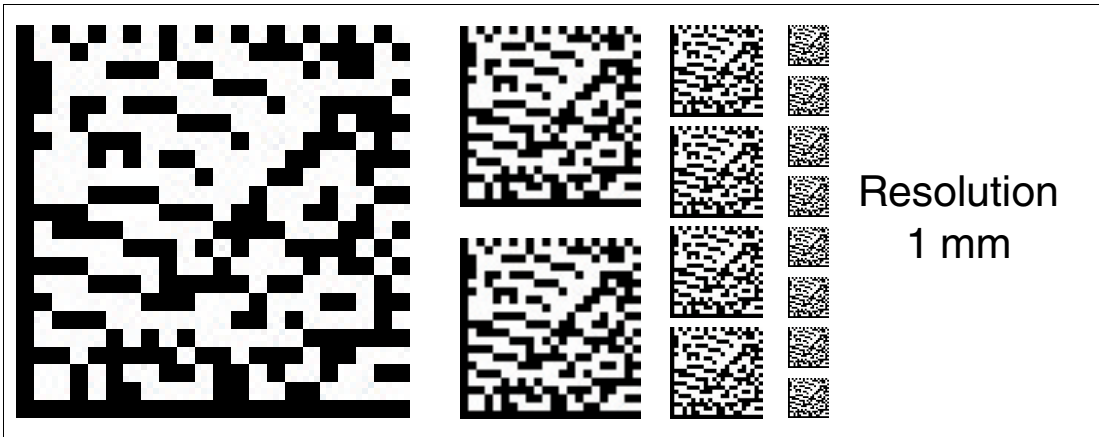

Figure 6.17 The code card assigns a position data resolution of 1 mm to the read head.

#### Resolution: 10 mm

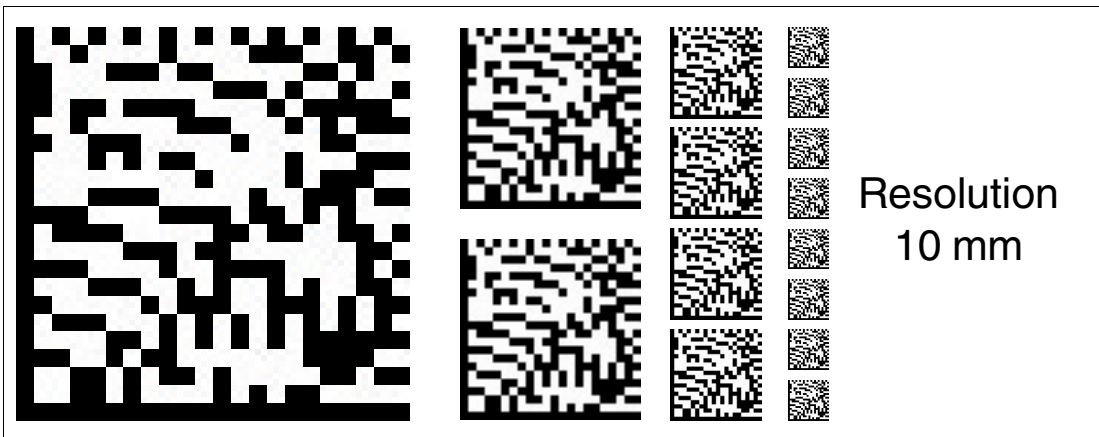

Figure 6.18 The code card assigns a position data resolution of 10 mm to the read head.

**Maximum Length of the Code Tape**

Resolution of the read head [mm]	Maximum length of the code tape [km]
10	10
1	10
0.1	1,5

**6.1.5 Code cards for adjusting the terminator**

Parameterization enables you to switch a terminator on and off in the read head:

**Terminator: OFF**

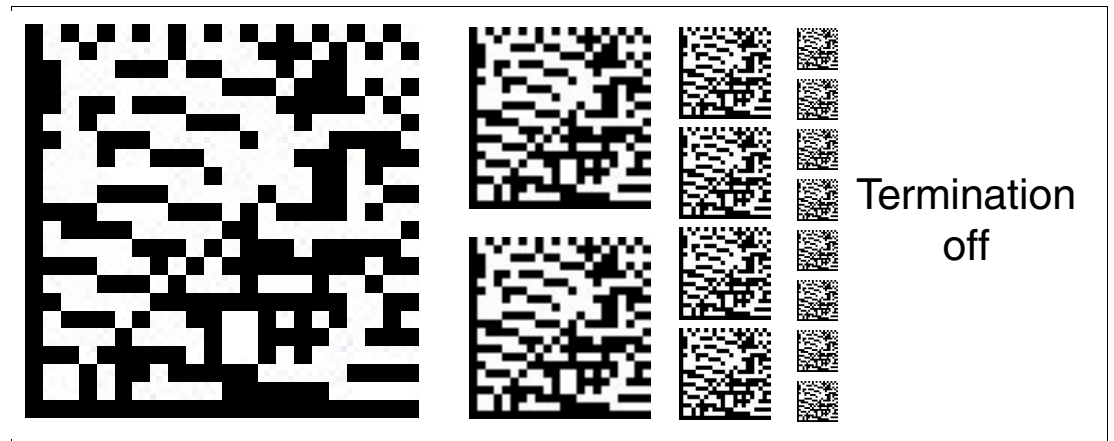

Figure 6.19 The terminator is deactivated.

**Terminator: ON**

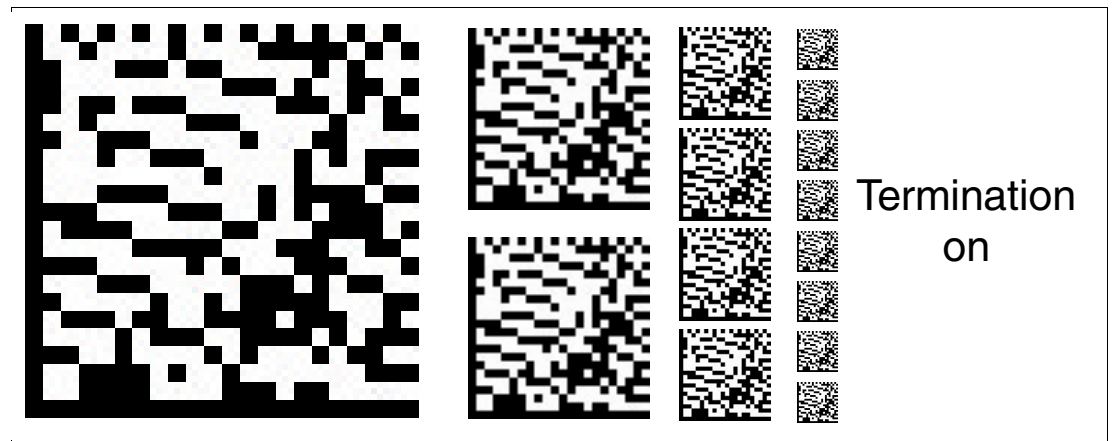

Figure 6.20 The terminator is connected.

# Your automation, our passion.

## Explosion Protection

- Intrinsic Safety Barriers
- Signal Conditioners
- FieldConnex® Fieldbus
- Remote I/O Systems
- Electrical Ex Equipment
- Purge and Pressurization
- Industrial HMI
- Mobile Computing and Communications
- HART Interface Solutions
- Surge Protection
- Wireless Solutions
- Level Measurement

## Industrial Sensors

- Proximity Sensors
- Photoelectric Sensors
- Industrial Vision
- Ultrasonic Sensors
- Rotary Encoders
- Positioning Systems
- Inclination and Acceleration Sensors
- Fieldbus Modules
- AS-Interface
- Identification Systems
- Displays and Signal Processing
- Connectivity

### Pepperl+Fuchs Quality

Download our latest policy here:

[www.pepperl-fuchs.com/quality](http://www.pepperl-fuchs.com/quality)

