

Robust. Precise. Blue.

With 460 nm, BlueBeam revolutionizes encoder technology—in standard and heavy-duty applications.

ENI90 Series Incremental
Rotary Encoder

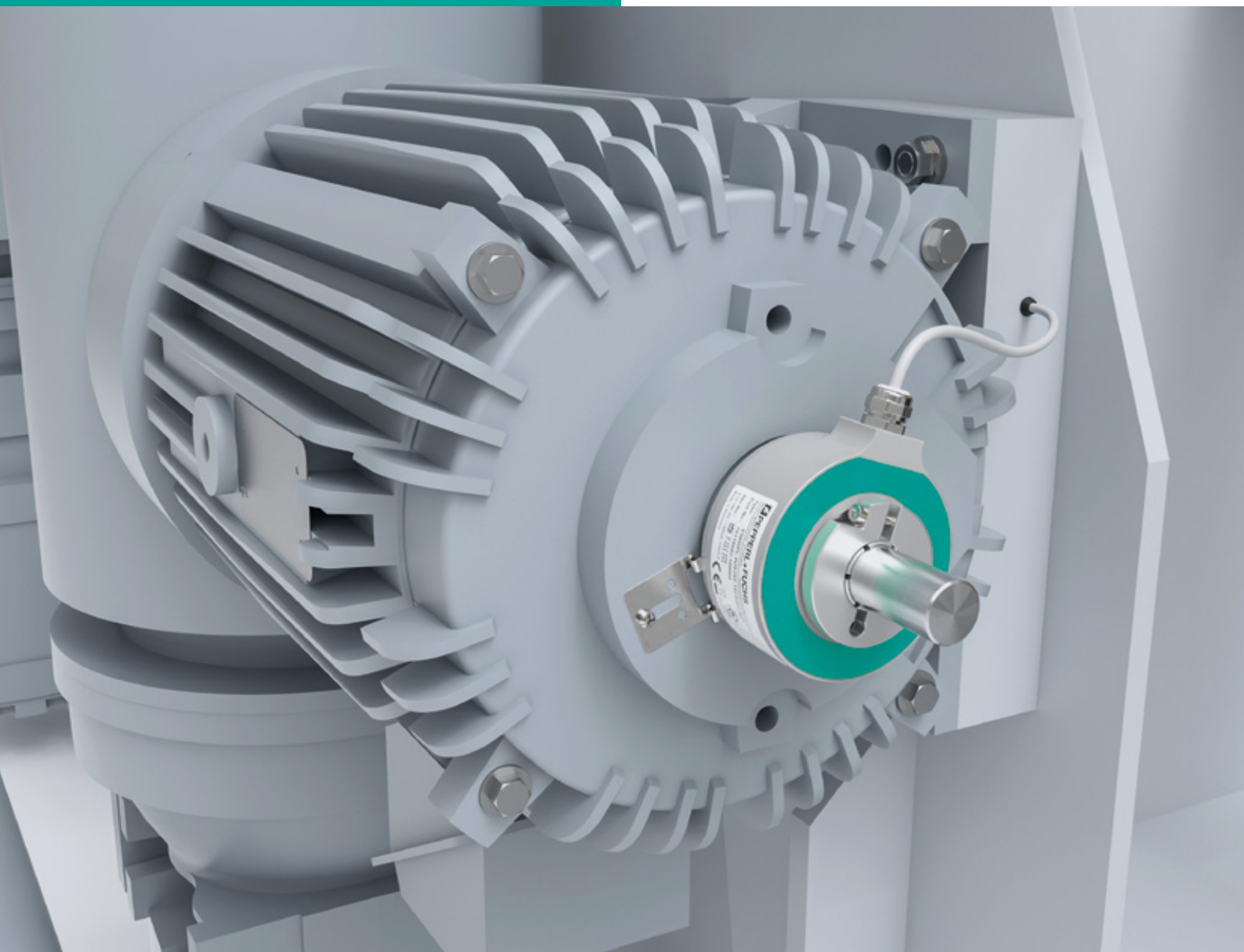

Your automation, our passion.

 **PEPPERL+FUCHS**

Reliably Accurate, Flexible in Use

The blue light of the BlueBeam technology enables the ENI90 series incremental rotary encoders to achieve the highest measurement accuracy—reliably, even under the toughest conditions. From the standard version to the heavy-duty version, the devices offer tailored solutions for every application.

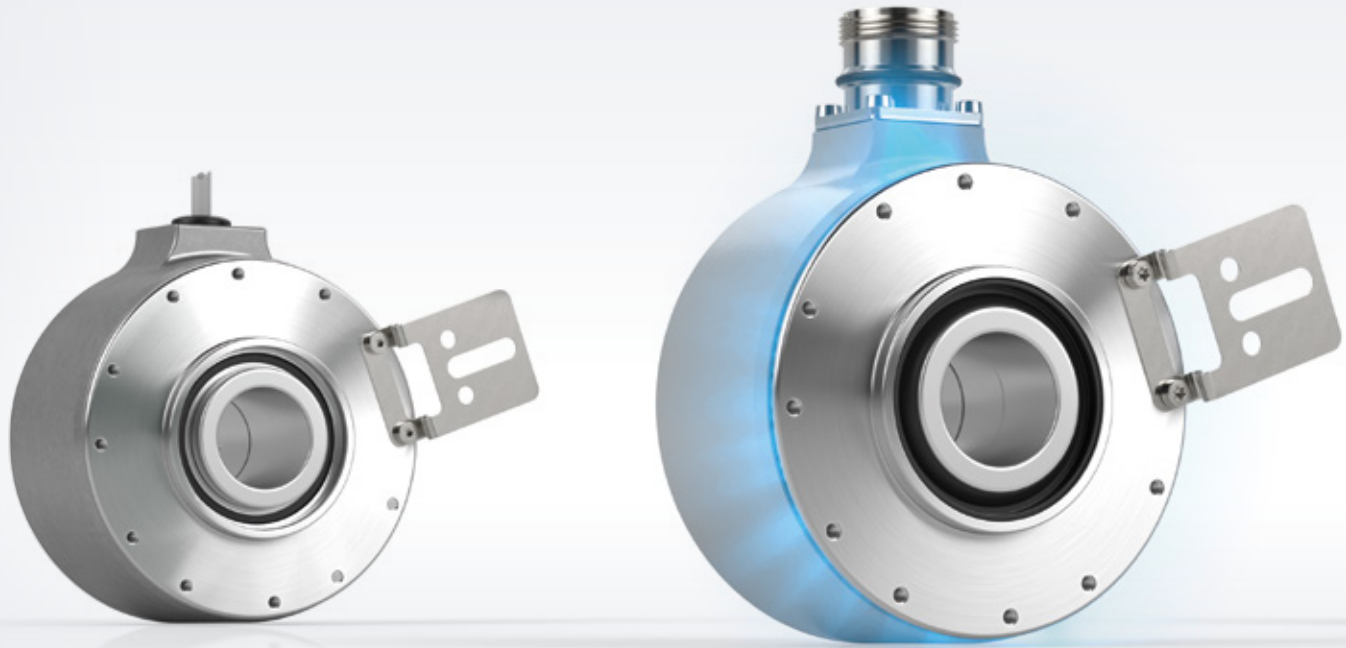

Maximum Precision—in Any Version

The ENI90 series hollow shaft rotary encoders are characterized by high signal quality and maximum precision in rotational speed measurement. Three device types and a comprehensive range of accessories offer almost unlimited configuration options for a wide variety of applications. They prove their worth wherever high-precision speed control is required, such as with electric motors or generators.

The ENI90IL basic version is the economical solution for all standard applications. The ENI90PL rotary encoder is designed for demanding environments, offering maximum resistance to shock and vibration. Its insulated shaft is suited for peak dielectric strengths of up to 2 kV. The EMC protection provides very high immunity for the rotary encoder. The ENI90HD heavy-duty version is available for extreme conditions. The devices in this series also provide powerful EMC protection, can withstand maximum shaft loads, and have a peak dielectric strength of up to 2.5 kV.



For more information, visit
[pepperl-fuchs.com/pf-eni90](https://www.pepperl-fuchs.com/pf-eni90)



Accessories

A wide range of connections and fasteners enables easy integration of the devices: spring plates, support plates, and articulated arms can serve as torque rests. They allow the rotary encoders to be secured optimally in any installation location. Comprehensive component sets are available for grounding and sealing the cable glands.

Technical data	ENI90IL 	ENI90PL 	ENI90HD, ENI90HO 
Max. rotational speed/degree of protection	3,000 rpm	6,000 rpm (IP65) 3,000 rpm (IP66 + IP67)	6,000 rpm (IP65) 3,000 rpm (IP66 + IP67)
Resolution	2,048 pulses	5,000 pulses	5,000 pulses
Absolute accuracy	$\leq \pm 0.025^\circ$	$\leq \pm 0.025^\circ$	$\leq \pm 0.025^\circ$
Ambient temperature	-20 °C ... 70 °C	-40 °C ... 85 °C	-40 °C ... 85 °C
Degree of protection	IP65	IP65 or IP66 + IP67	IP65 or IP66 + IP67
Shock/vibration resistance	100 g/10 g	300 g/30 g	200 g/20 g
Shaft load (axial/radial)	50 N/100 N	50 N/100 N	100 N/300 N
Electrical interface	Universal current driver or RS422	Universal current driver or RS422	Universal current driver or RS422
Connection type	Cable, radial: 1 m or 5 m	Cable, radial: 1 m, 2 m, 3 m, 5 m, 10 m plug, radial: M23 cw, M23 ccw, M12 5-pin, M12 8-pin, MIL 7-pin, MIL 10-pin	Cable, radial: 1 m, 2 m, 3 m, 5 m, 10 m plug, radial: M23 cw, M23 ccw, M12 5-pin, M12 8-pin, cable duct
Shaft	25 mm, 38 mm, 5/8", 1"	20 mm, 25 mm, 30 mm, 38 mm, 1/2", 5/8", 3/4", 7/8", 1" Insulated shaft up to 2 kV for 20 mm, 25 mm, 30 mm	12 mm, 16 mm, 17 mm Insulated shaft up to 2.5 kV for 12 mm, 16 mm, 17 mm

BlueBeam Increases Signal Quality

The blue light ensures optimal imaging of the code disc and enables precision in signal detection. BlueBeam is ideal for dynamic applications and delivers consistently reliable measurement results, even at maximum speed.

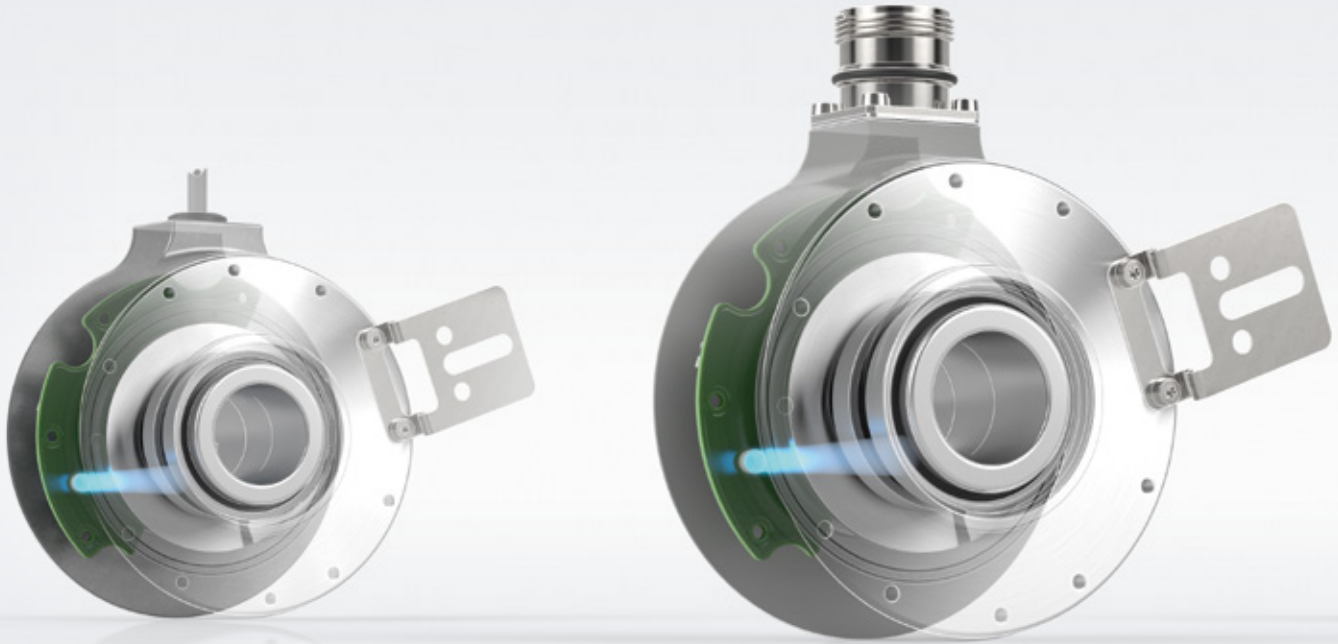

Superior Technology for High-Accuracy Scanning

The optical scanning principle of the BlueBeam technology and the finely structured sensing chips increase efficiency and precision in signal generation. The wavelength of 460 nm is optimal: this provides a sharp image of the code disc for high-accuracy output.

The blue light optimizes the signal amplitude and enables a significantly higher resolution than other light colors. At the same time, it minimizes signal flutter (jitter). These strengths not only increase signal quality, they also make the rotary encoders particularly resistant to mechanical influences caused by vibration and shock. Downtimes are reduced and plant availability increases. The broad portfolio of the ENI90 series unlocks these benefits of BlueBeam for almost any application.



Highlights

- Unmatched precision due to BlueBeam technology—whether in standard or heavy-duty applications
- Robust and compact: housing design focused on the essentials
- Particularly durable due to strong shock resistance, even at rotational speeds up to 6,000 rpm
- High mounting flexibility due to tapped holes in 60° steps and various accessories

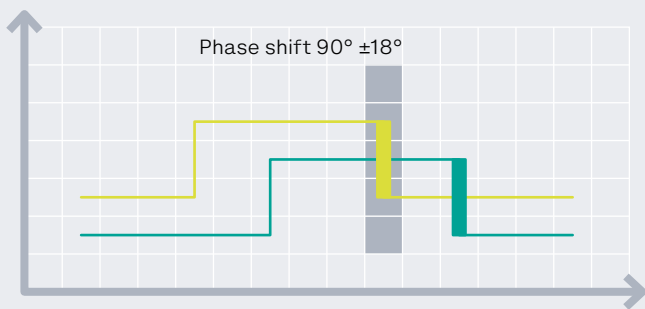

Conventional rotary encoder: 200 kHz max. output frequency

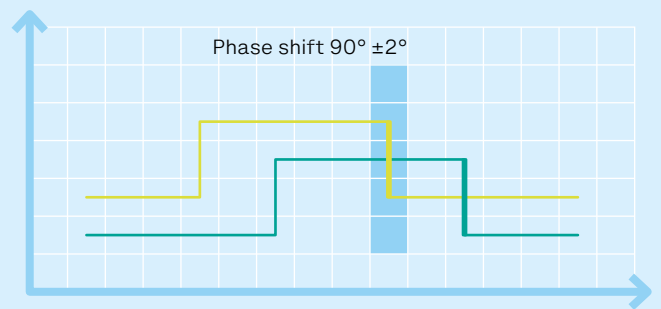

Pepperl+Fuchs ENI90PL: 400 kHz max. output frequency

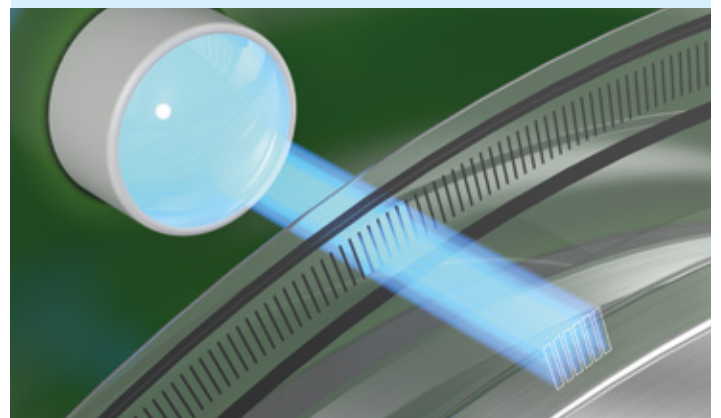
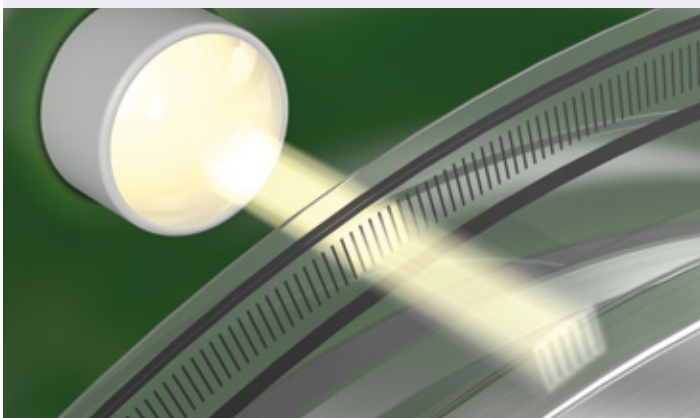

Resistant, Durable, and Maximum Dielectric Strength

In power electrics, the spontaneous voltage flashover can destroy ball bearings and important electronic components. The ENI90PL and ENI90HD series rotary encoders are effectively protected against this hazard. Their wear-resistant ball bearings insulate the electronics against the shaft current.

No Hazard Due to Voltage Flashover

A shaft current can be generated in the shaft of an electric motor or generator by electromagnetic induction. For larger machines, it often reaches high values. The hollow shaft of the rotary encoder is mounted on the shaft and is therefore exposed to the risk of a voltage flashover. The current in a

conventional rotary encoder finds its way through the steel ball bearing in this case. When this happens, damage is caused by spark erosion or burning of the lubricant. This damages the function of the bearing and drastically reduces its durability.

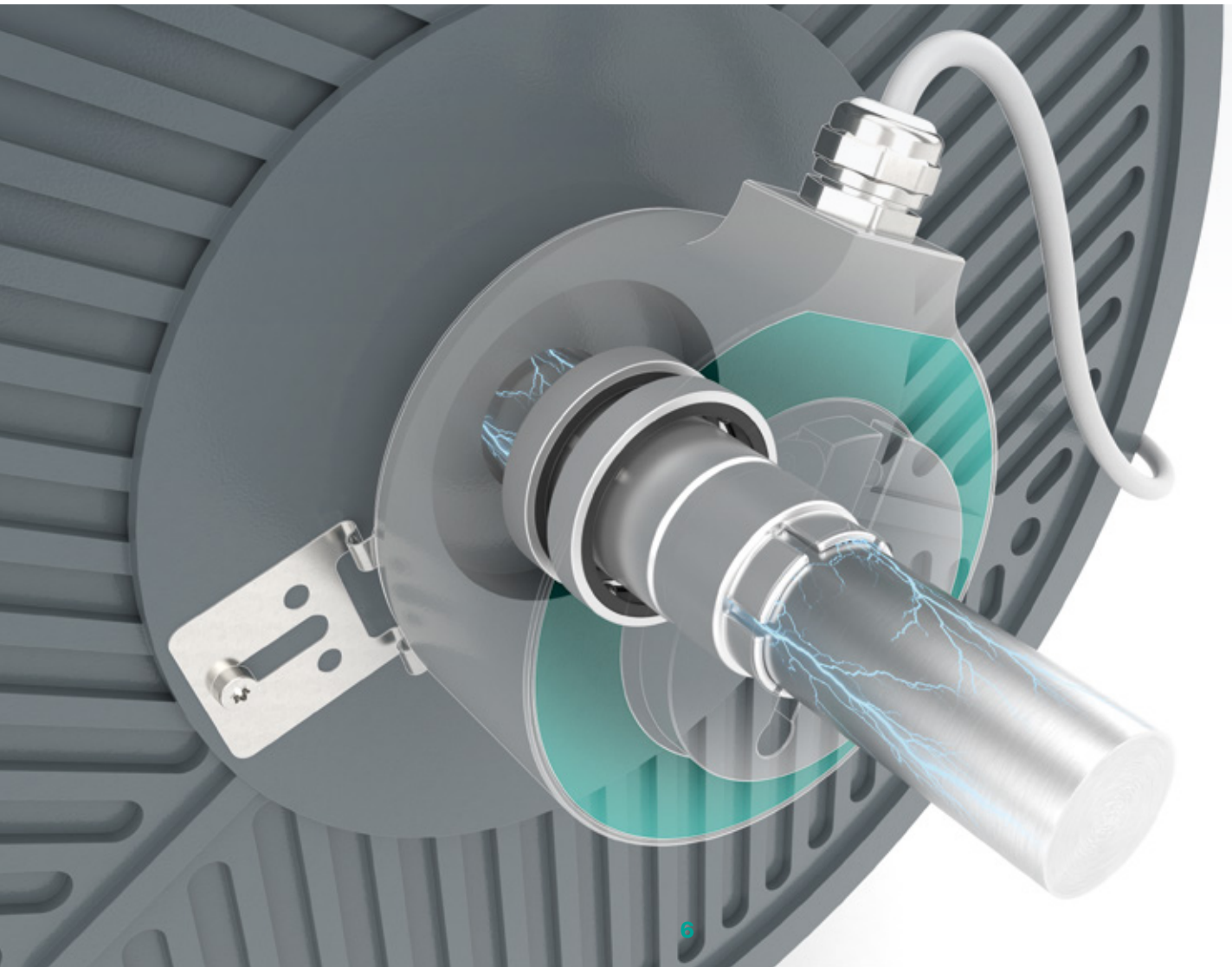

The hybrid ball bearings of the ENI90PL and ENI90HD rotary encoders are equipped with ball bearings made of nonconductive high-performance ceramics. These prevent voltage flashover up to a voltage of 2 kV and 2.5 kV, respectively. They are also extremely hard, abrasion-, and wear-resistant. Shaft currents at this level cannot damage the rotary encoder, and the electronics inside the housing remain effectively insulated. These features guarantee maximum reliability and durability even under

extreme operational conditions. The above-average size of the blocked bearing unit creates additional reserves for exceptional peak loads: even if it is at the maximum speed limit, the encoder can still maintain a long operating life.

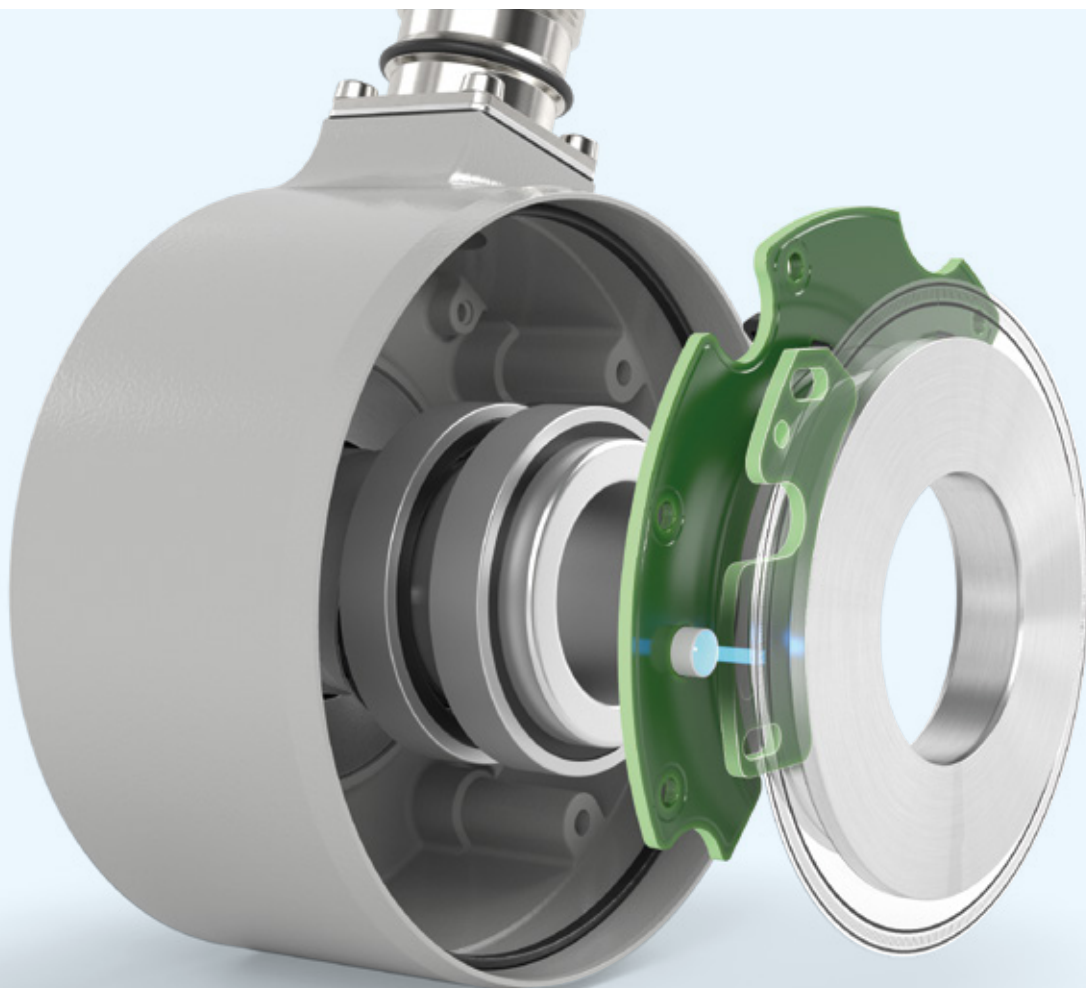

Applications

Tough Conditions, Exact Rotational Speed

Harsh conditions are no problem for the ENI90 series incremental rotary encoders. They record the rotational speed precisely, consistently, and reliably, even under the toughest requirements: sea air in port facilities, heat and shock in steel mills, extreme weather conditions, and continuous loads in wind-turbine nacelles cannot harm them.

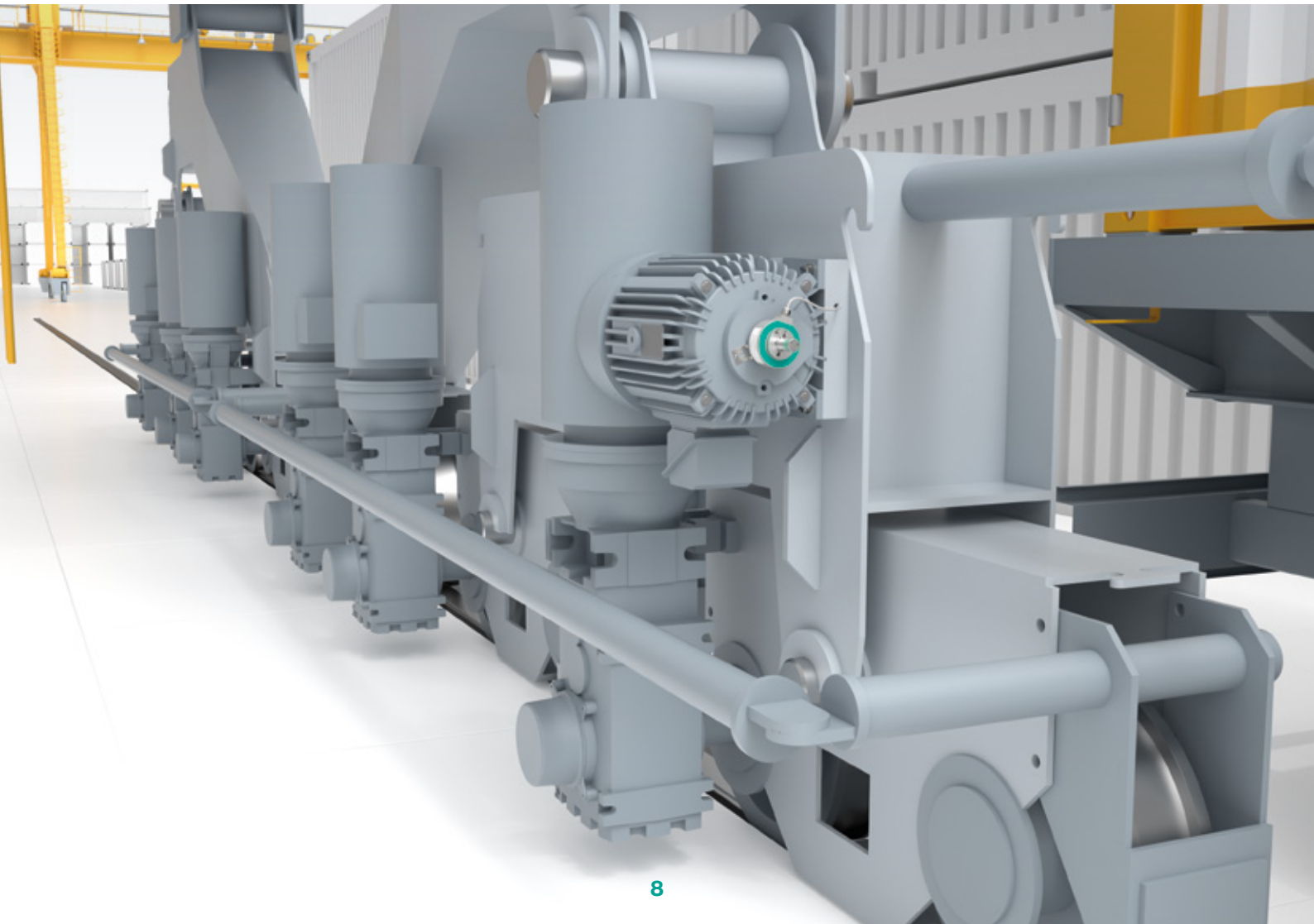



Crane System

Port facilities at the sea are exposed to wind, weather, and constant corrosion by salt water. The equipment has to be able to withstand large mechanical loads. Here, the fail-safe ENI90HO, the offshore version of the heavy-duty ENI90HD rotary encoder, made of saltwater-resistant aluminum, offers the optimal solution. Its housing design and generously dimensioned bearings make it highly resistant to shock and vibration. It always reliably detects the rotational speed at the drive shaft of the crane system so that the ships can be loaded and unloaded without interruption.

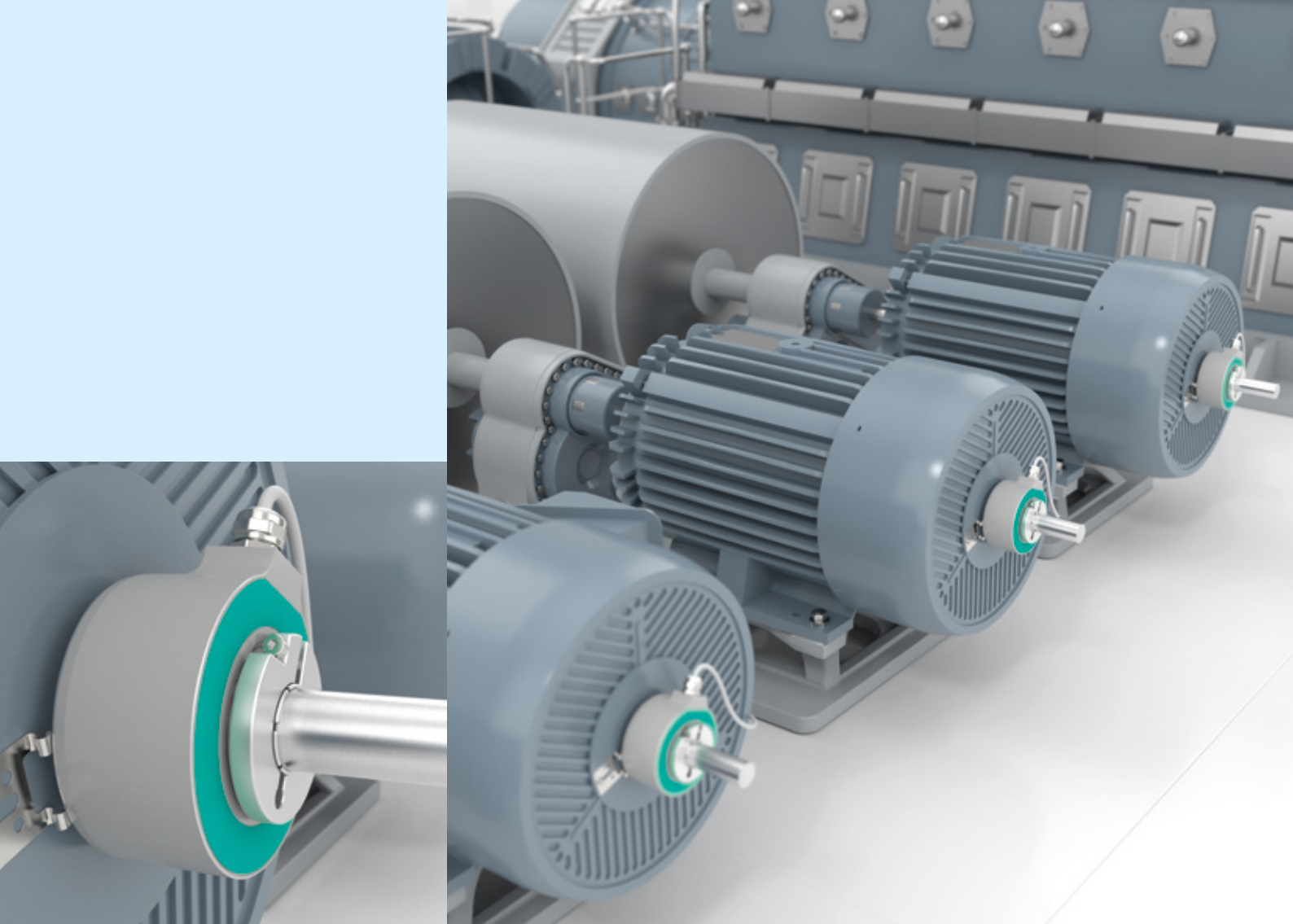

Steel Mills

Crude steel is processed in the rolling mill into preliminary products such as sheets, pipes, rods, and carriers. Rotating rollers press hot and cold material into the desired shape. Product quality depends on the precise synchronization of the input and output speeds of successive roll stands. The motors of the rolling mills have to run smoothly and be reliably protected against overspeed. Here, ENI90 series rotary encoders ensure accurate rotational speed measurement under the harsh conditions of the steel industry. They help prevent malfunction and plant downtime.

Wind Turbines

Wind turbines are often located at sea or are inaccessible in the mountains. They have to supply electricity constantly without interruptions. Rotational speed measurement is crucially important here: its signal enables precise control for optimal energy yield and protects the plant from overload. High humidity, large temperature fluctuations, and the mechanical influences of the variable wind load must not play a role here. An ENI90 series rotary encoder on the generator shaft ensures consistently precise rotation speed monitoring.

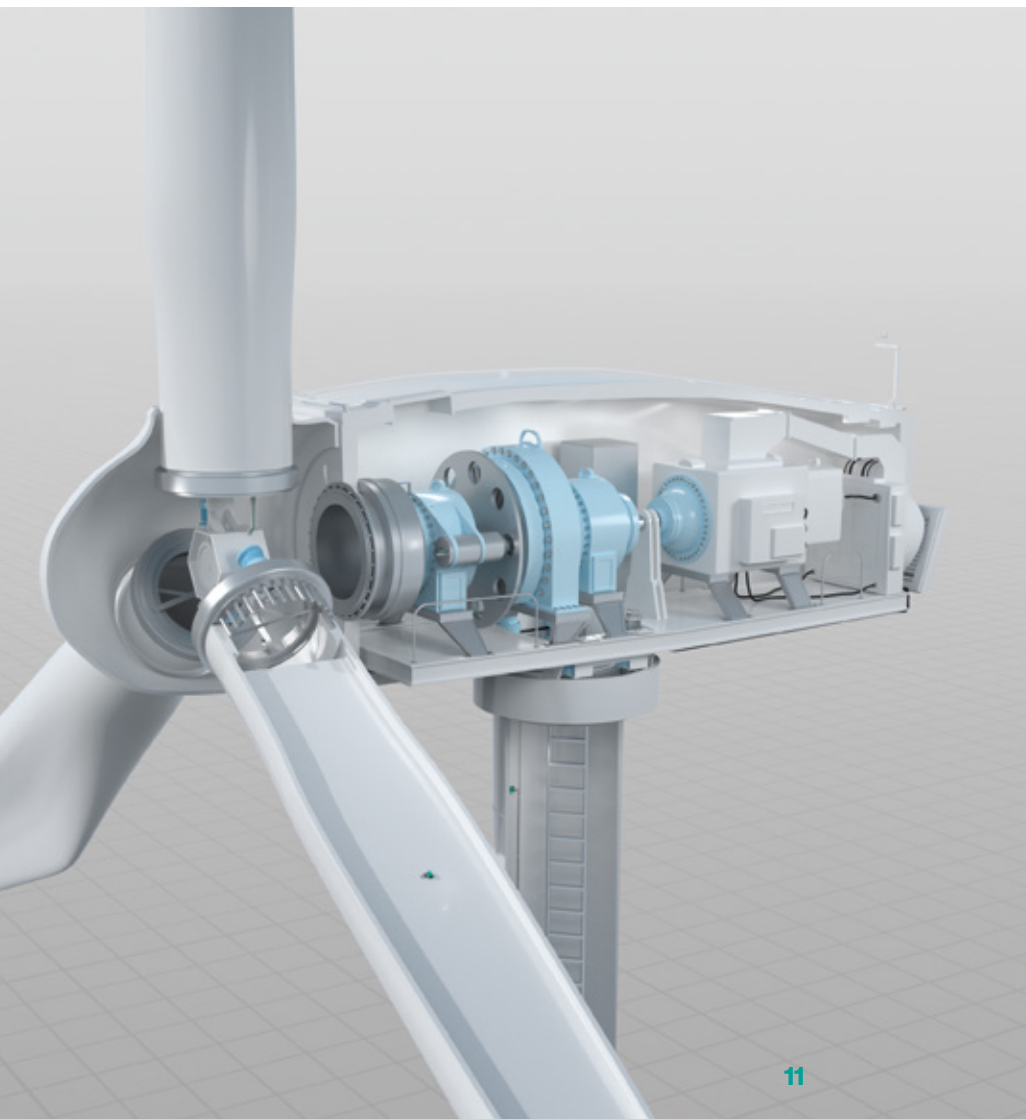

Your automation, our passion.

Explosion Protection

- Intrinsic Safety Barriers
- Signal Conditioners
- FieldConnex® Fieldbus Infrastructure
- Remote I/O Systems
- Electrical Explosion Protection Equipment
- Purge and Pressurization Systems
- HMI Systems
- Mobile Computing and Communications
- HART Interface Solutions
- Surge Protection
- Wireless Solutions
- Level Measurement

Industrial Sensors

- Proximity Sensors
- Photoelectric Sensors
- Industrial Vision
- Ultrasonic Sensors
- Rotary Encoders
- Positioning Systems
- Inclination and Acceleration Sensors
- Vibration Monitoring
- Industrial Ethernet
- AS-Interface
- IO-Link
- Identification Systems
- Displays and Signal Processing
- Connectivity

www.pepperl-fuchs.com

Subject to modifications • © Pepperl+Fuchs
Printed in Germany • Part. No. 70143603 08/22 02 • public



Pepperl+Fuchs Quality

Download our latest policy here:

www.pepperl-fuchs.com/quality