

# Measure. Detect. Automate.

Integrated measuring functions,  
rapid object detection and  
three-way crossover.

Automation Light Grids:  
LGS and LGM Series

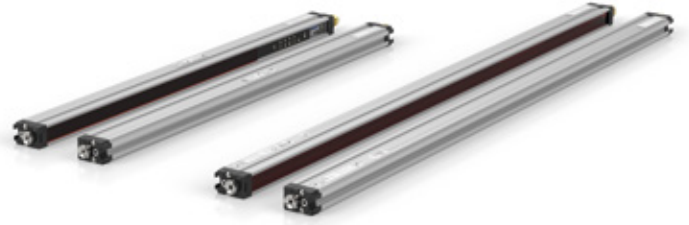

Your automation, our passion.

 **PEPPERL+FUCHS**

Automation Light Grid

# Easy Integration of Object Detection

Pepperl+Fuchs light grids are extremely easy to use due to simple plug-and-play installation and plug-and-play installation and parameterization.

## Typical Applications

- Height and object detection in the packaging industry and in warehousing and material handling
- Detecting and counting irregular objects
- Determining the position of and measuring objects
- Detecting irregular shaped objects
- Identifying objects

## The Benefits of Selected Products at a Glance

### LGS light grid:

- Simple, software-free parameterization via touch pad or external teach
- Extremely quick object detection—even with three-way crossover
- IO-Link interface for service and process data
- Integrated object detection for object identification

### LGM measuring light grid:

- Simple to use due to 16 integrated, freely to choose measuring functions
- Convenient integration by direct measured value output in millimeters—without complex single-beam evaluation
- Simple adjustment and evaluation via IO-Link interface
- Rugged IP67 degree of protection







# Automation Light Grid LGS: A Clever Solution with Many Extras

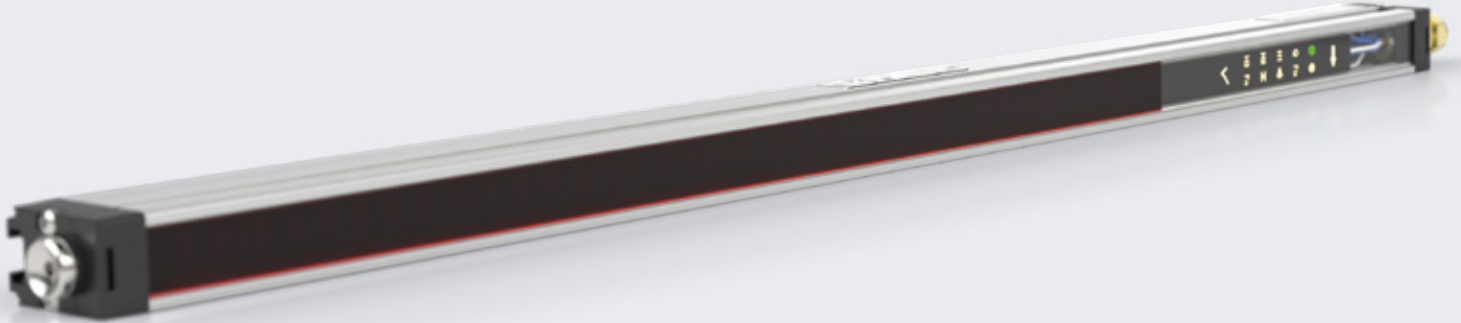

**In addition to standard functions, LGS series light grids feature a range of useful extra functions previously found only in much more expensive device classes.**

## Remarkable Functions for Many Applications

LGS light grids offer ultra-quick object detection even with beam crossover, the option of identifying objects, and remote communication via an IO-Link interface. The blanking function can also be used to deactivate two connected beam areas if unfavorable installation conditions result in plant components extending into and interrupting the detection field. The signal strength (tracking is switched off in the factory settings) is continuously monitored during each start-up, and during operation to compensate for influences based on temperature changes or pollution.

A special low-temperature version is available for use in ambient temperatures from  $-30\text{ °C}$  ...  $+60\text{ °C}$ . In this version, the transmitter and receiver are independently temperature-compensated. With a wide range of operating modes, individually adjustable lengths, and various resolutions, the LGS light grids can be used in a wide range of automation technology applications.



The portfolio is available at  
[pepperl-fuchs.com/pf-LGS](https://pepperl-fuchs.com/pf-LGS)



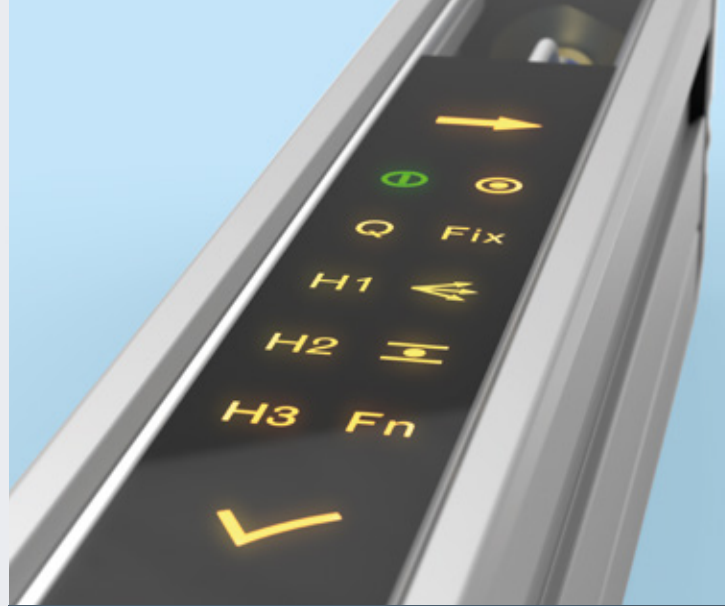
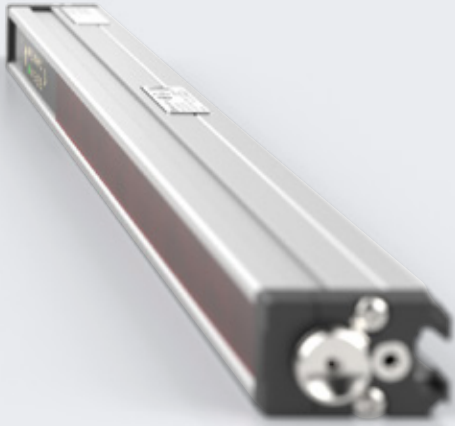

### Highlights

- Extremely slim modular light grid with integrated analyzer
- Quick and easy three-sided mounting via plug and play
- Rapid object detection, including reflective objects
- Beam crossover without reducing the response time
- Software-free parameterization via touch field or external input

### Excerpt of Technical Data

### LGS

<b>Effective detection range</b>	0.3 to 6 m (standard) 0.5 to 8 m (option/35)
<b>Field height</b>	Min. 100 mm, max. 3200 mm (in 100 mm increments)
<b>Beam spacing</b>	8 mm, 17 mm, 25 mm, 50 mm, 100 mm
<b>Crossover</b>	3-way beam crossover
<b>Optical resolution</b>	Without crossover: 8 mm/with crossover: 4 mm
<b>Operating elements</b>	2 touch buttons on the receiver for parameterization
<b>Operating indicator</b>	LED green: power on/short circuit/low voltage/power save mode/IO-Link
<b>Function indicator</b>	LED yellow: switch state/operating reserve/test/error
<b>Response time</b>	Typically 5 ms with 100 beams
<b>Operating voltage</b>	18 to 30 V DC, Class 2
<b>Switching type</b>	Light-on/dark-on switching, adjustable
<b>Switching output (detection field)</b>	1 push-pull output, short-circuit proof, reverse polarity protected
<b>Switching outputs (height checking)</b>	3 push-pull outputs, short-circuit proof, reverse polarity protected
<b>Test input and range input</b>	Transmitter with test input and range switching
<b>Function input</b>	For external parameterization
<b>Degree of protection</b>	IP67
<b>Operating temperature</b>	-10 °C ... +60 °C (standard) -30 °C ... +60 °C (option/146)
<b>Connection</b>	200 mm fixed cable with M12 plug

# Optimized for a Wide Range of Applications

Automatic signal calibration, simple height setting without a PC, and integrated object detection—the light grids in the LGS series offer a wide range of functions for use in standard applications or more demanding applications.

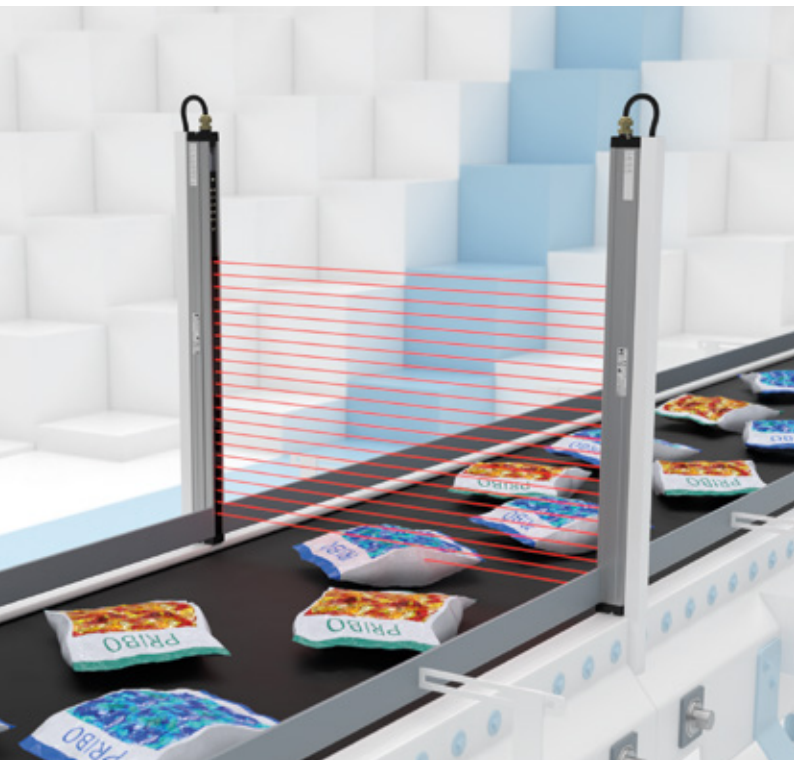

## For Standard Applications Such as Object Detection and Overhang Monitoring

- Rapid object detection, even with three-way beam crossover
- Typical response time of only 5 ms with 100 beams
- Beam crossover enables detection of even the smallest objects, down to 4 mm
- Automatic signal calibration
- Beam suppression areas (blinking)

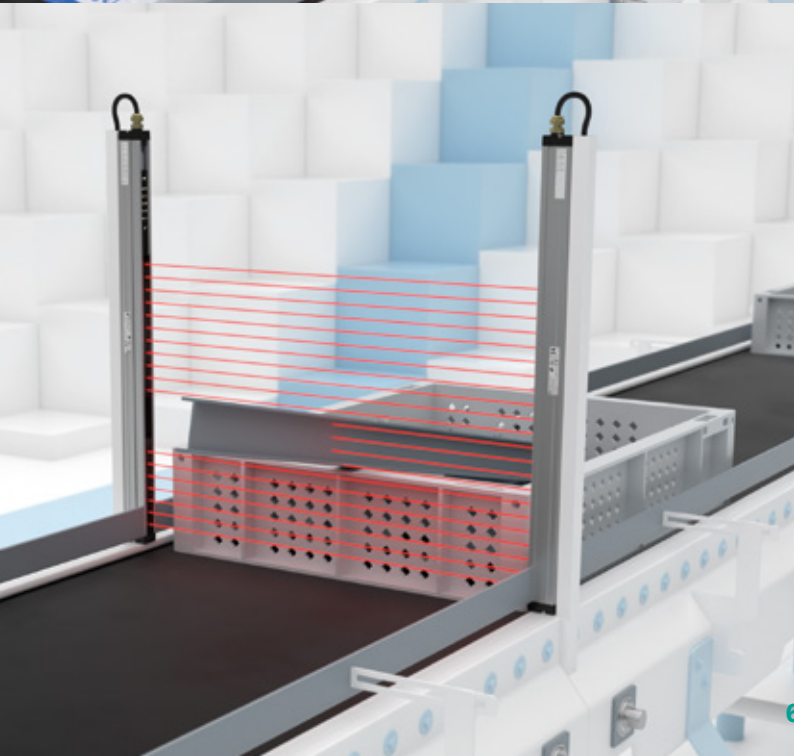

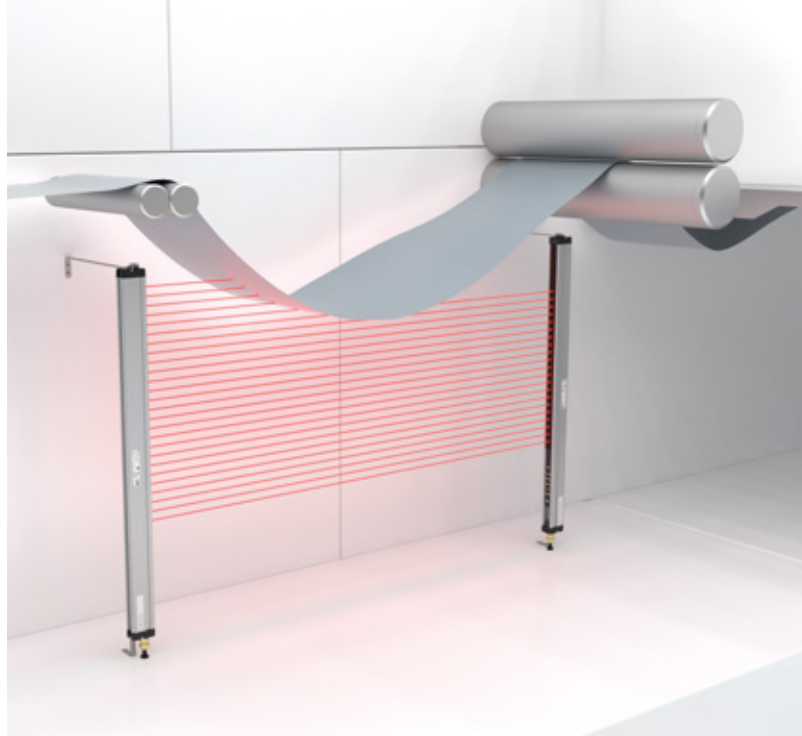

### For Complex Applications Such as Height or Sag Monitoring

- Set heights easily without a PC
- Rapid object detection, even with three-way beam crossover
- Three separate outputs on the receiver for height monitoring
- A beam bundle (at least one beam) can be assigned to each of the three outputs
- Beam suppression areas (blanking)

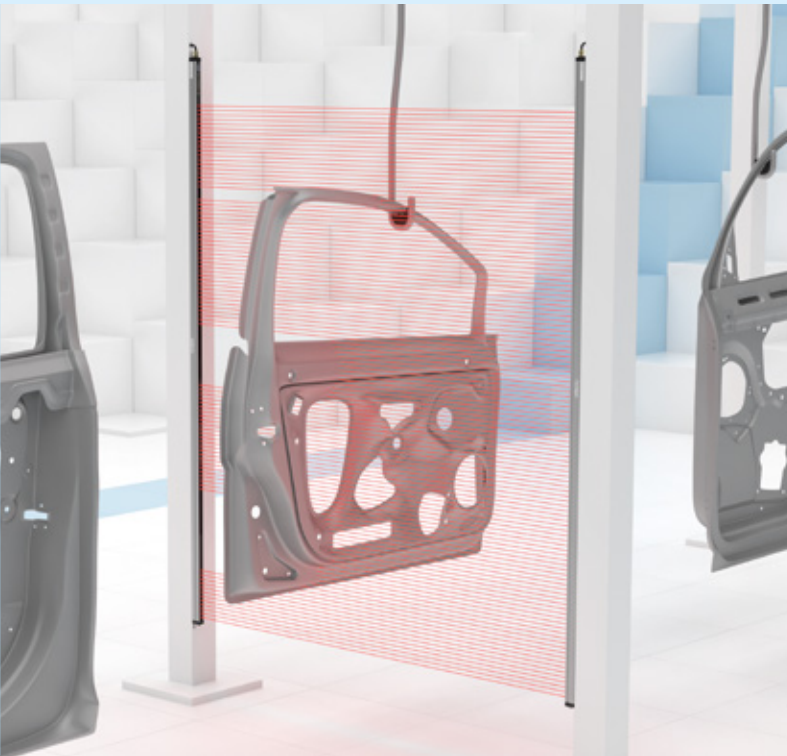

### For Object Identification via Integrated Object Detection





- Any object can be taught in at the push of a button
- The position is taught in automatically when the object is taught in
- The object position can be defined as floating or fixed
- Inverted teach-in function for gaps and openings

# Simple Programming, Parameterization, and Diagnostics



## Touch Field for Easy Operation

The light grids in the LGS series can be parameterized and taught via a touch field. The touch field allows simple step-by-step parameterization without additional software or equipment. The touch field can be locked via the keyboard for safe operation.

### Touch Buttons and Function Indicators

	<b>Menu button</b>	Function selection
	<b>OK button</b>	Function confirmation
	<b>Green LED</b>	Power on/short circuit/low voltage/ power save mode/IO-Link
	<b>Yellow LED</b>	Switch state/operating reserve/ test/fault state

### Function Status Indicators Level 1

Q	<b>Switching output</b>	Teach in object or display object detection
H1	<b>Height output 1</b>	Teach in height 1 or display taught-in height 1
H2	<b>Height output 2</b>	Teach in height 2 or display taught-in height 2
H3	<b>Height output 3</b>	Teach in height 3 or display taught-in height 3
	<b>Object position</b>	Object detection for moving objects Object detection for static objects
	<b>Crossover</b>	Beam crossover activated Beam crossover deactivated
	<b>Object tolerance</b>	Object tolerance beam activated Object tolerance beam deactivated
F2	<b>F2</b>	Activate second level

### Function Status Indicators Level 2

Q	<b>Q (F2)</b>	Beam suppression (blinking) for interfering objects
H1	<b>H1 (F2)</b>	Inverse operation (gap detection)
H2	<b>H2 (F2)</b>	Light-on/dark-on switching mode
H3	<b>H3 (F2)</b>	Reset factory setting





# IO-Link for Intelligent Parameterization and Diagnostics

As the first globally standardized technology, IO-Link enables continuous, bidirectional communication between the control level and the lowest sensor/actuator level using an unshielded three-wire standard cable. With this future-proof interface, users can perform extensive diagnostics or assign parameters to IO-Link devices during operation.

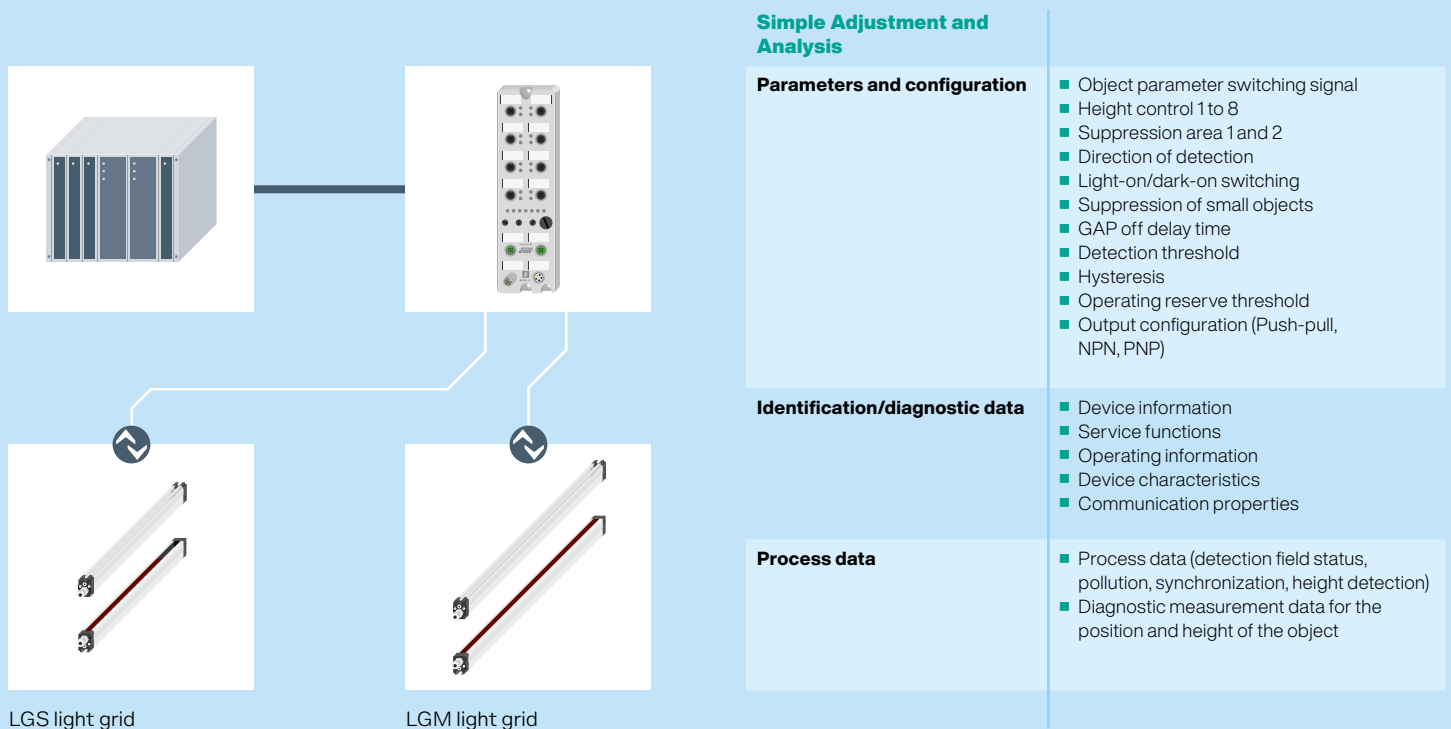

## Practical Accessories for Simplest Installation

Innovative quick-release mounting brackets are available for easy installation and quick replacement of LGS and LGM light grids. They allow tool-free attachment to all three sides of the profile with plug-and-play connectivity. Further flexible mounting options include a continuous M6 groove on the rear of the profile and the option for the customer to make transverse holes for four screws.

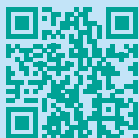

For accessories, see  
[pepperl-fuchs.com/pf-LGS-LGM](https://www.pepperl-fuchs.com/pf-LGS-LGM)

# LGM Measuring Light Grid: A Flexible Solution for Various Applications

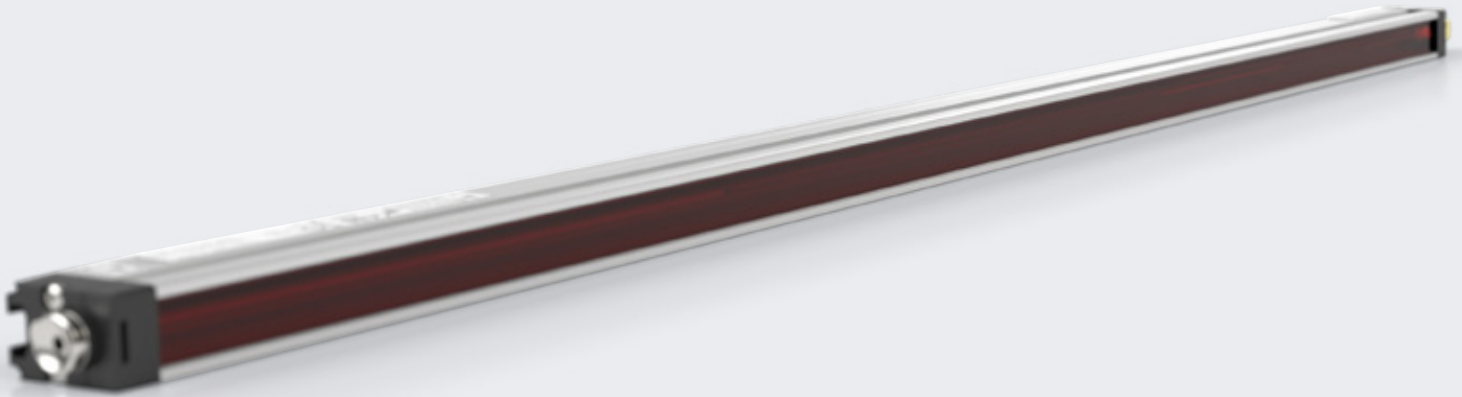

Measuring light grids in the LGM series are tailored to all common warehouse and material handling applications.

## 16 Integrated, Freely Selectable Measuring Functions for Maximum Flexibility

Instead of complex single-beam evaluation, the measurement value of the LGM grids are available in millimeters via the IO-Link interface. 16 integrated measuring functions that can be freely selected make the light grids ready for use immediately. The LGM light grids reliably detect each object via infrared rays and measure the size of the object using the interrupted rays.

A special low-temperature version is available for use in ambient temperatures from  $-30\text{ °C}$  ...  $+60\text{ °C}$ . In this version, the transmitter and receiver are independently temperature-compensated.



Find the portfolio at  
[pepperl-fuchs.com/pf-LGM](https://pepperl-fuchs.com/pf-LGM)

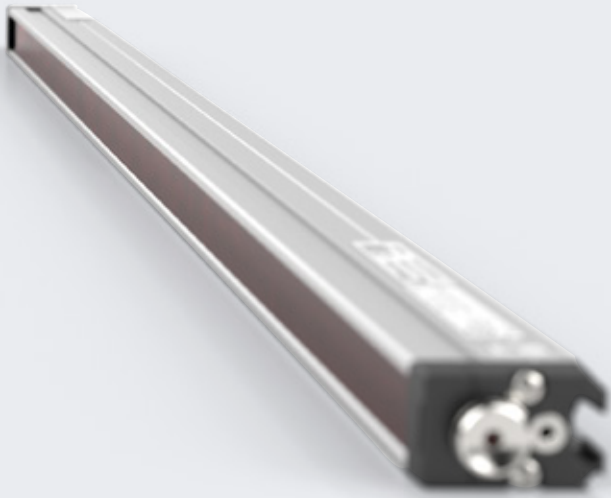

### Highlights

- Various resolutions and field heights up to 3200 mm
- Slim housing design for tight spaces
- Compact aluminum housing with IP67 degree of protection
- Measurement value in millimeters
- Simple parameterization and diagnostic information via IO-Link

### Excerpt of Technical Data

### LGM

<b>Effective detection range</b>	0.3 to 6 m
<b>Field height</b>	Min. 100 mm, max. 3200 mm (in 100 mm increments)
<b>Beam spacing</b>	8 mm, 17 mm, 25 mm, 50 mm
<b>Beam crossover</b>	3-way (can be disabled)
<b>Optical resolution</b>	Without beam crossover: 8 mm, with beam crossover: 4 mm
<b>Test input</b>	Transmitter: transmitter switch-off
<b>Ambient light limit</b>	50,000 lux
<b>Temperature range</b>	-30 °C ... +60 °C
<b>Degree of protection</b>	IP67
<b>Connection</b>	200 mm fixed cable with M12 plug (pigtail)
<b>Housing cross section</b>	20 × 30 mm



# Simple Adjustment and Analysis via IO-Link

IO-Link enables simple setup, parameterization, and remote configuration of the light grids from the control level. General operating parameters, measurement output modes, and operating values for object identification can be set or changed quickly and easily—even during operation.

## The Appropriate Measuring Function for Every Application

The user can choose between 16 different, integrated operating modes for object measurement. Other functions such as object identification and blanking are also available.

Due to the intelligent parameter management, settings can also be adjusted quickly for a variety of devices within a plant. Extensive diagnostic information during operation enables demand-oriented maintenance and prevents unwanted plant downtimes.

## Flexible Object Measurement

The required measuring function can be selected from 16 different parameter settings for object measurement, known as measurement value parameters. For example, the object height, the lowest or highest object position, or the sum and average value can be displayed in millimeters.

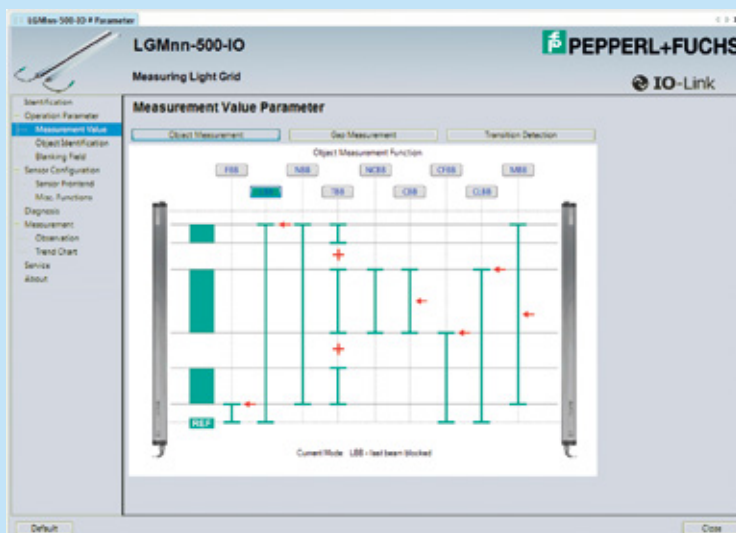

## Examples

- FBB First beam blocked (overall) = lowest object position across all partial objects (in mm)
- LBB Last beam blocked (overall) = highest object position across all partial objects (in mm)
- NBB Number of beams blocked (overall) = object height across all partial objects,  $NBB = LBB - FBB$  (in mm)
- TBB Total beams blocked = object height as sum of the height of all partial objects (in mm)

## Reliable Object Identification

In addition to measuring objects, the teach-in function can also be used to detect and identify objects by their profile. Depending on the application, four different object identification parameters are available.

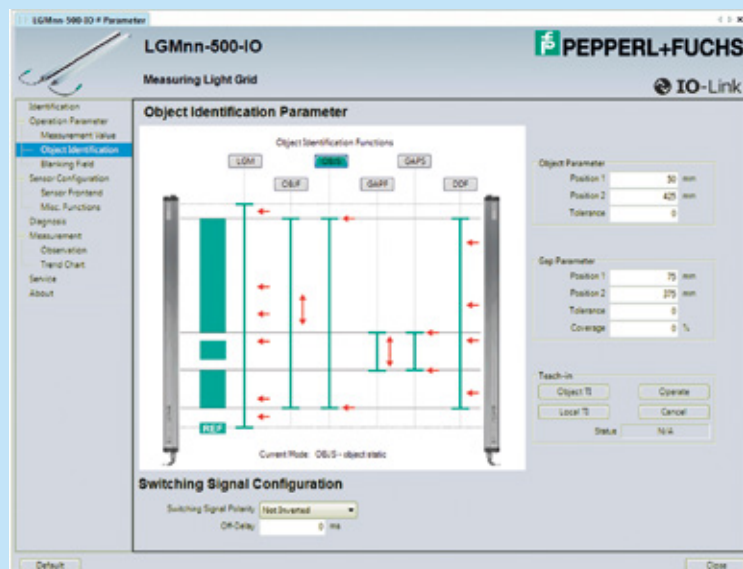

## Examples

**OBJ S** Static object identification = an object is detected when the upper and lower limits match the parameterized positions of the object area

**OBJ F** Floating object identification = a floating object is detected when the height corresponds to the distance of the parameterized positions for the object area

# A Wider Range of Applications Due to Reliable Measuring and Identification

## Object Height Measurements

Measuring functions such as LBB (last beam blocked) can be selected via IO-Link: This function determines the highest object position across all partial objects. As soon as a pallet containing goods passes and interrupts the infrared beams of the light grids, the highest interrupted light beam determines the height of the object. The measured value is sent directly to the control panel in millimeters and can be processed further.

Measuring functions such as NBB (number of beams blocked) can be selected via IO-Link: This function determines the height of the object across all interrupted beams. The lowest and highest interrupted beams are used to determine the size of the object.

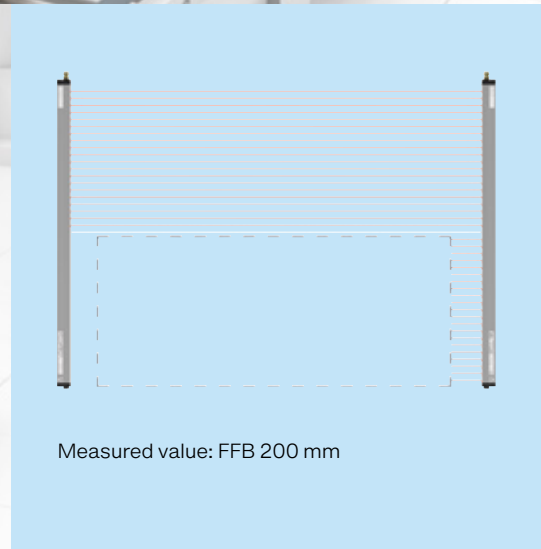
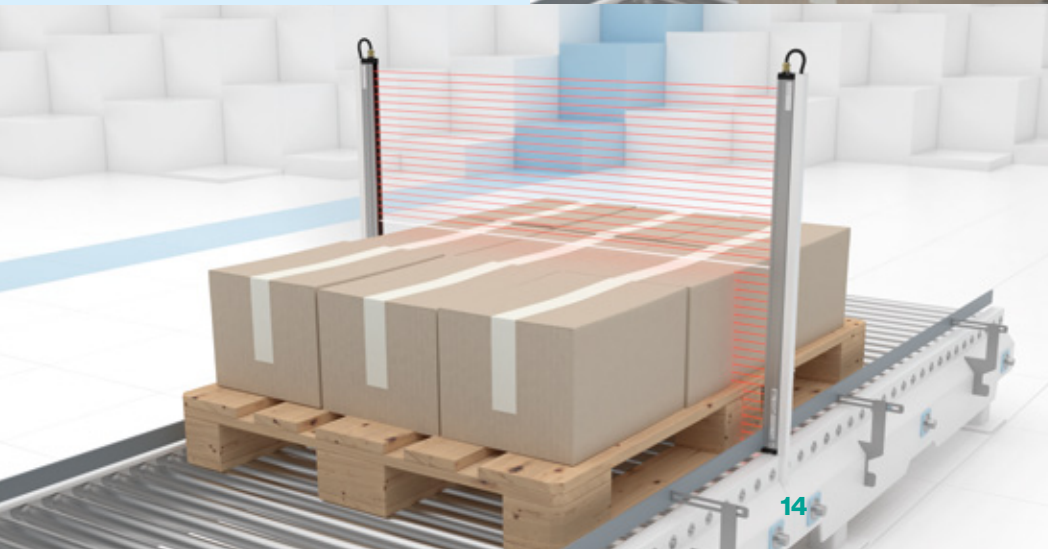
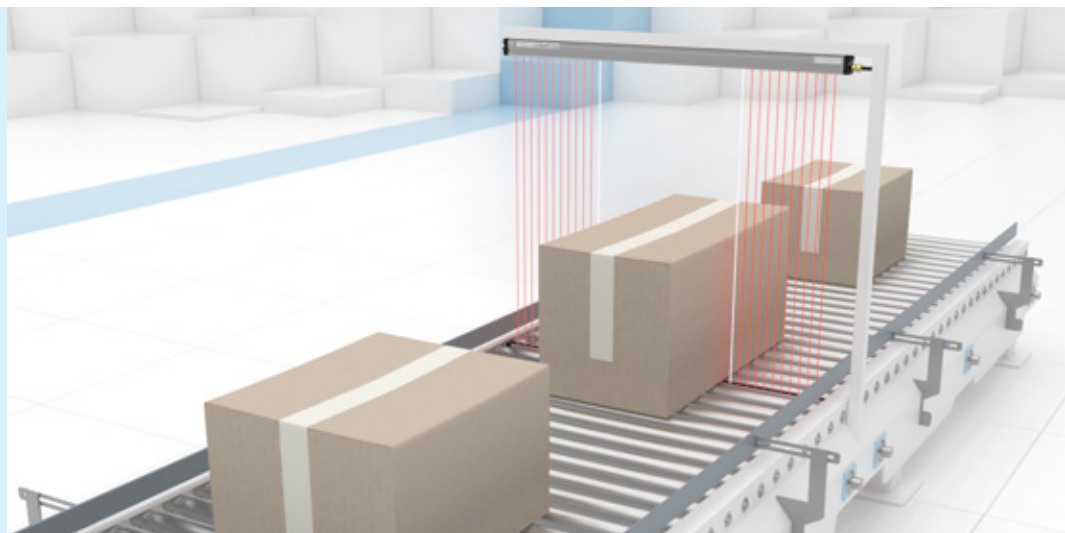
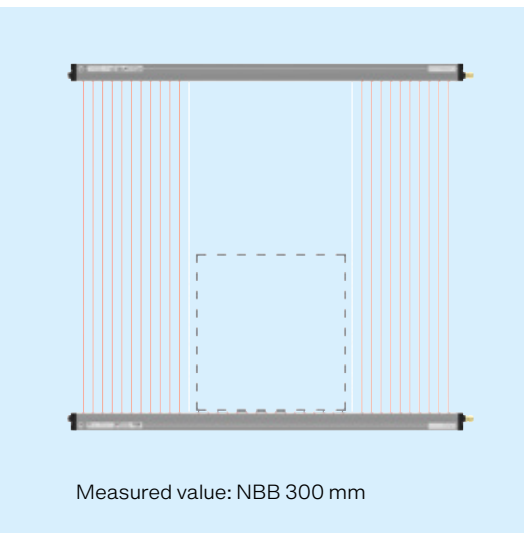
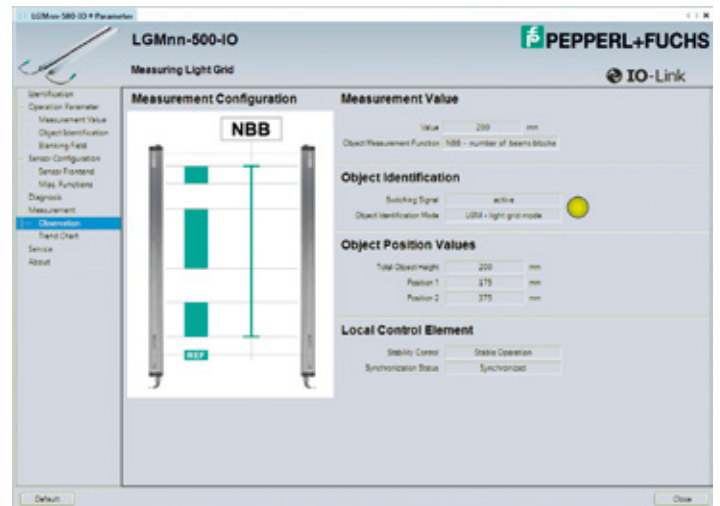



## Volume Measurements

The measurement functions can also be easily combined with one another: By mounting the light grids horizontally and vertically on the conveyor belt, the volume can also be measured by combining the object height and object width measurements.

## Object Identification

In addition to measuring objects, light grids in the LGM series can also detect and identify objects by their shape and position. Object identification modes such as OBJS (static object identification) can be selected via IO-Link. Floating mode can also be used for moving objects.

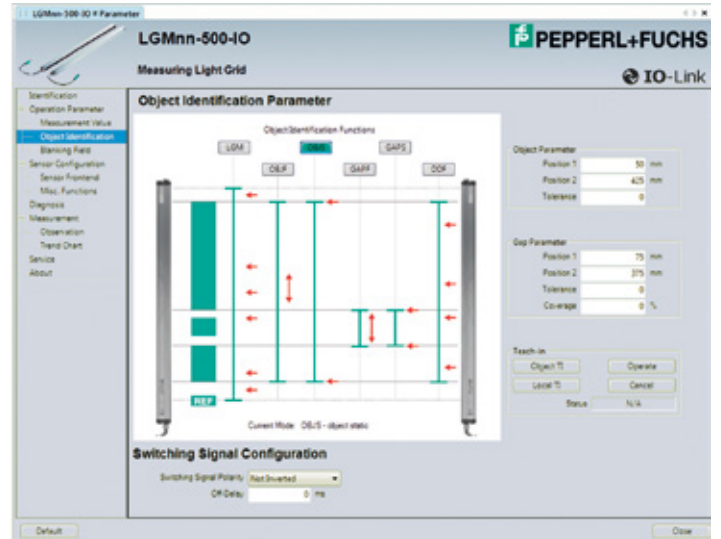

# Your automation, our passion.

## Explosion Protection

- Intrinsic Safety Barriers
- Signal Conditioners
- FieldConnex® Fieldbus Infrastructure
- Remote I/O Systems
- Electrical Explosion Protection Equipment
- Purge and Pressurization Systems
- HMI Systems
- Mobile Computing and Communications
- HART Interface Solutions
- Surge Protection
- Wireless Solutions
- Level Measurement

## Industrial Sensors

- Proximity Sensors
- Photoelectric Sensors
- Industrial Vision
- Ultrasonic Sensors
- Rotary Encoders
- Positioning Systems
- Inclination and Acceleration Sensors
- Vibration Monitoring
- Industrial Ethernet
- AS-Interface
- IO-Link
- Identification Systems
- Displays and Signal Processing
- Connectivity

[www.pepperl-fuchs.com](http://www.pepperl-fuchs.com)

Subject to modifications • © Pepperl+Fuchs  
Printed in Germany • Part. No. 70147123 02/22 00 • public



**Pepperl+Fuchs Quality**

Download our latest policy here:

[www.pepperl-fuchs.com/quality](http://www.pepperl-fuchs.com/quality)