

PXV100AQ-F200-R4-V19

Data Matrix  
Positioning System

Manual

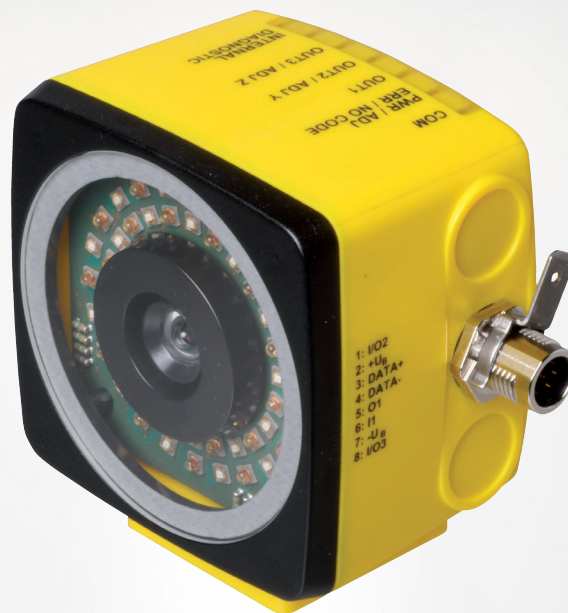

---

With regard to the supply of products, the current issue of the following document is applicable:  
The General Terms of Delivery for Products and Services of the Electrical Industry, published  
by the Central Association of the Electrical Industry (Zentralverband Elektrotechnik und Elek-  
troindustrie (ZVEI) e.V.) in its most recent version as well as the supplementary clause:  
"Expanded reservation of proprietorship"

**Worldwide**

Pepperl+Fuchs Group  
Lilienthalstr. 200  
68307 Mannheim  
Germany  
Phone: +49 621 776 - 0  
E-mail: [info@de.pepperl-fuchs.com](mailto:info@de.pepperl-fuchs.com)

**North American Headquarters**

Pepperl+Fuchs Inc.  
1600 Enterprise Parkway  
Twinsburg, Ohio 44087  
USA  
Phone: +1 330 425-3555  
E-mail: [sales@us.pepperl-fuchs.com](mailto:sales@us.pepperl-fuchs.com)

**Asia Headquarters**

Pepperl+Fuchs Pte. Ltd.  
P+F Building  
18 Ayer Rajah Crescent  
Singapore 139942  
Phone: +65 6779-9091  
E-mail: [sales@sg.pepperl-fuchs.com](mailto:sales@sg.pepperl-fuchs.com)  
<https://www.pepperl-fuchs.com>

<b>1</b>	<b>Introduction.....</b>	<b>5</b>
1.1	Content of this Document.....	5
1.2	Target Group, Personnel .....	5
1.3	Symbols Used .....	6
<b>2</b>	<b>Safety Information .....</b>	<b>7</b>
2.1	Intended Use .....	7
2.2	Useful Lifetime .....	7
<b>3</b>	<b>Product Description .....</b>	<b>9</b>
3.1	Components of the Positioning System.....	9
3.2	Use and Application .....	10
3.3	LED Indicators and Operating Elements.....	13
3.4	Accessories.....	15
<b>4</b>	<b>Transport and Storage .....</b>	<b>16</b>
<b>5</b>	<b>Planning.....</b>	<b>17</b>
5.1	Position Detection – Structural Principle .....	17
5.2	Plant Design .....	17
5.3	Safety-Related Reading Range of the Read Head .....	18
5.4	Read Head Orientation for the Data Matrix Code Tape .....	19
5.5	Characteristics of the Data Matrix Codes and Code Redundancy .....	20
5.6	Read Head Orientation.....	22
5.6.1	Horizontal Tolerance – Read Distance z .....	22
5.6.2	Vertical Tolerance - Height Tolerance y .....	23
5.6.3	Inclination Angle .....	26
5.6.4	Rotational Tolerance in the z Axis .....	27
5.7	Expansion Joints / Gaps .....	28
5.8	Behavior of the Read Head When Cornering .....	35
<b>6</b>	<b>Installation and Commissioning .....</b>	<b>38</b>
6.1	General .....	38
6.2	Applying the Data Matrix Code Tape.....	38
6.3	Mounting and Alignment of the Read Head .....	41
6.3.1	Mounting the Read Head .....	42
6.3.2	Alignment of the Read Head.....	45
6.4	Electrical Connection .....	48

6.5	Connecting the Read Head to the PUS Evaluation Unit.....	50
6.6	The RS-485 Interface .....	51
6.7	Commissioning the Read Head with the PUS Evaluation Unit via safeControl Expert.....	52
<b>7</b>	<b>Maintenance .....</b>	<b>56</b>
7.1	Maintenance .....	56
7.2	Testing.....	56
7.3	Cleaning.....	57
7.4	Repairs .....	57
<b>8</b>	<b>Disposal .....</b>	<b>58</b>

# 1 Introduction

## 1.1 Content of this Document

This document contains information required to use the product in the relevant phases of the product life cycle. This may include information on the following:

- Product identification
- Delivery, transport, and storage
- Mounting and installation
- Commissioning and operation
- Maintenance and repair
- Troubleshooting
- Dismounting
- Disposal



---

**Note**

For full information on the product, refer to the further documentation on the Internet at [www.pepperl-fuchs.com](http://www.pepperl-fuchs.com).

---



---

**Note**

For specific device information such as the year of construction, scan the QR code on the device. As an alternative, enter the serial number in the serial number search at [www.pepperl-fuchs.com](http://www.pepperl-fuchs.com).

---

The documentation comprises the following parts:

- This document
- Datasheet

In addition, the documentation may comprise the following parts, if applicable:

- EU-type examination certificate
- EU declaration of conformity
- Attestation of conformity
- Certificates
- Control drawings
- Instruction manual
- Functional safety manual
- Other documents

## 1.2 Target Group, Personnel

Responsibility for planning, assembly, commissioning, operation, maintenance, and dismantling lies with the plant operator.

Only appropriately trained and qualified personnel may carry out mounting, installation, commissioning, operation, maintenance, and dismantling of the product. The personnel must have read and understood the instruction manual and the further documentation.

Prior to using the product make yourself familiar with it. Read the document carefully.

## 1.3 Symbols Used

This document contains symbols for the identification of warning messages and of informative messages.

### Warning Messages

You will find warning messages, whenever dangers may arise from your actions. It is mandatory that you observe these warning messages for your personal safety and in order to avoid property damage.

Depending on the risk level, the warning messages are displayed in descending order as follows:



---

#### **Danger!**

This symbol indicates an imminent danger.

Non-observance will result in personal injury or death.

---



---

#### **Warning!**

This symbol indicates a possible fault or danger.

Non-observance may cause personal injury or serious property damage.

---



---

#### **Caution!**

This symbol indicates a possible fault.

Non-observance could interrupt the device and any connected systems and plants, or result in their complete failure.

---

### Informative Symbols



---

#### **Note**

This symbol brings important information to your attention.

---



---

#### **Action**

This symbol indicates a paragraph with instructions. You are prompted to perform an action or a sequence of actions.

## 2 Safety Information

Read the information in this document carefully and observe this information when working with the device. Failure to observe the safety information and warning messages in this documentation can lead to malfunctions of the safety devices of the machines or plants in which they are fitted.

This can result in serious personal injury or death.

### Target Group, Personnel

Responsibility for planning, assembly, commissioning, operation, maintenance, and dismantling lies with the plant operator.

The personnel must be appropriately trained and qualified in order to carry out mounting, installation, commissioning, operation, maintenance, and dismantling of the device. The trained and qualified personnel must have read and understood the instruction manual.

Prior to using the product make yourself familiar with it. Read the instruction manual carefully.

### Reference to Further Documentation

Observe directives, standards, and national laws applicable to the intended use and the operating location.

## 2.1 Intended Use

### Use

The **Data Matrix Positioning System** is the positioning system in the Pepperl+Fuchs incident light process. The heart of the system is the read head, which consists of a camera module with an internal illumination unit. This enables the read head to detect position markers printed onto a self-adhesive code tape in the form of 2-D **Data Matrix codes**.

The **Data Matrix code tape** is mounted on a fixed part of the plant (e.g., the wall of an elevator shaft or the rail of a monorail conveyor). The read head is mounted on a moving "vehicle" positioned in parallel with the code tape (e.g., on the elevator cab or on the chassis of a monorail conveyor).

The **read head** is connected to the PUS evaluation unit. In the PUS evaluation unit, the red/blue color switching of the read head is activated, and a safe position and safe speed are calculated from the position marks detected.

### Misuse

Use the read head only in conjunction with the PUS evaluation unit as described in the documentation and in accordance with the technical specifications. The use of unapproved or inappropriate Data Matrix code tapes or Data Matrix metal code bars, or the use of the read head outside the specified use will cause a predictable malfunction. In this case, any warranty or liability of the manufacturer shall cease.

## 2.2 Useful Lifetime

The useful lifetime is specified in the characteristic safety values. .

Although, on the basis of a probabilistic estimate, a constant failure rate is assumed, this only applies under the condition that the useful lifetime of the components is not exceeded. The result of this probabilistic estimate is only applicable until the useful lifetime ends, as the probability of a failure significantly increases thereafter. This useful lifetime largely depends on the component itself and its operating conditions, particularly the temperature. For example, electrolytic capacitors are very sensitive to the operating temperature.

This assumption of a constant failure rate is based on the course of a typical bathtub curve for electronic components.

It is therefore clear that this failure calculation only applies to components that have this constant range, and that the validity of the calculation is limited to the useful lifetime of each component.

It is assumed that the majority of early failures are detected during installation and that, therefore, a constant failure rate applies during the useful lifetime.

Use the device only within the specified ambient and operating conditions.



### 3 Product Description

#### 3.1 Components of the Positioning System

The positioning system described in this manual consists of the following components:



Figure 3.1 System overview

- Read head **PXV100AQ-F200-R4-V19**, hereinafter referred to as "read head" in this document.
- 2-colored Data Matrix code tape **PXV\*-AA25-\***, hereinafter referred to as "Data Matrix code tape" in this document.  
Data Matrix metal code bars **PXV\*-AAM-\***, hereinafter referred to as "Data Matrix metal code bars" in this document.
- Safe evaluation unit **PUS-F161-B\*-PXV**, hereinafter referred to as "PUS evaluation unit" in this document.

## 3.2 Use and Application

### Data Matrix Positioning System

The **Data Matrix Positioning System** is the positioning system in the Pepperl+Fuchs incident light process. The heart of the system is the read head, which consists of a camera module with an internal illumination unit. This enables the read head to detect position markers printed onto a self-adhesive code tape or metal code bar in the form of 2-D **Data Matrix codes**. Each individual code contains information that is made visible by a two-color red and blue LED lighting and is read by the camera. The data is output to the **PUS evaluation unit**. The data can be processed there and used for process control. The PUS evaluation unit is a device that can be used to implement safety shutdowns and safety functions. It enables the calculation of safe position and velocity data for an axis from the data of the read head. The PUS evaluation unit ensures the safety-related evaluation and transmission of data via a safe and non-safe fieldbus, including x position, speed and diagnostic data, and safe input and output signals.

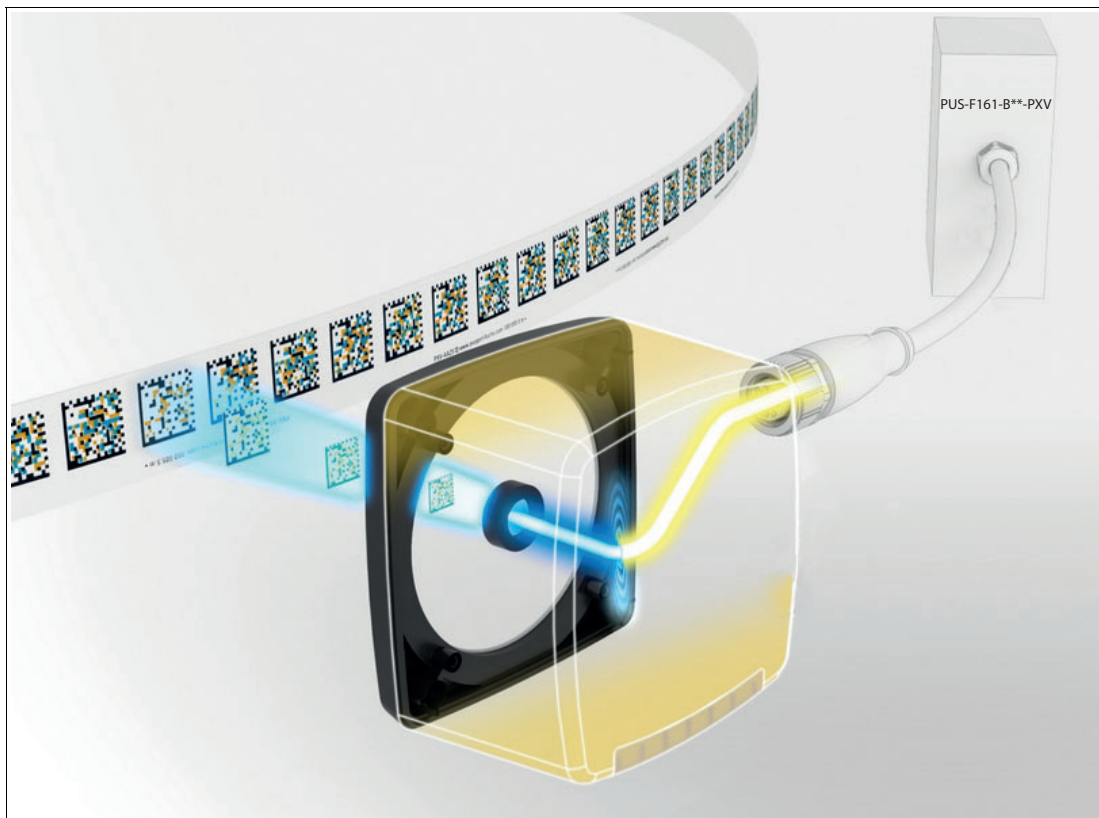

### Data Matrix Code Tape

The **Data Matrix code tape** is mounted on a fixed part of the plant (e.g., the wall of an elevator shaft, or the rail on a monorail conveyor). The read head is mounted on a "carrier" that moves parallel to the code tape (e.g., on the elevator cabin or on the chassis of a monorail conveyor).

The two-color Data Matrix code tape is illuminated by the red/blue illumination unit on the read head and is read by the camera. If the red LED ring of the read head is active, the blue and black areas of the Data Matrix code are visible. If the blue LED ring of the read head is active, the red and black areas of the Data Matrix code are visible.

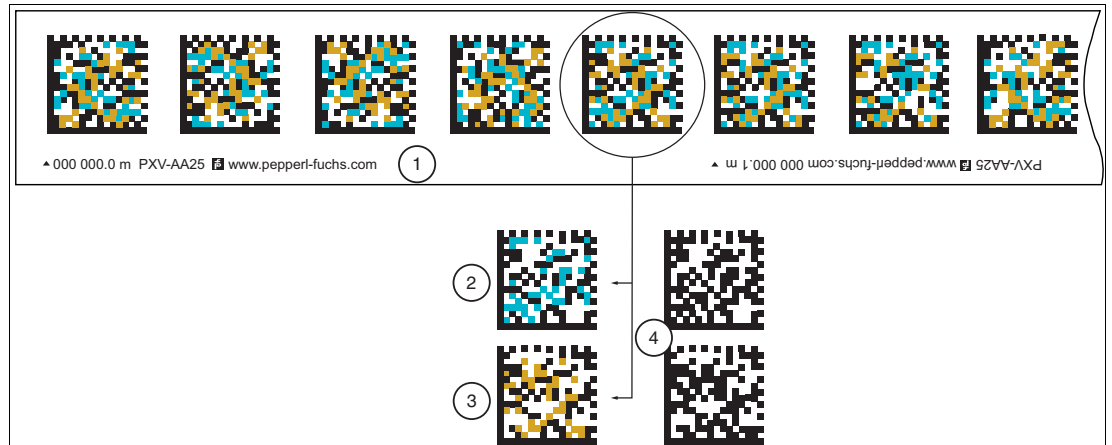

Figure 3.2 Schematic diagram: 2-colored Data Matrix code tape

- 1 2-colored Data Matrix code tape
- 2 Data Matrix code with red lighting
- 3 Data Matrix code with blue lighting
- 4 Monochrome Data Matrix codes



**Note**

**Note the type of code tape!**

The positioning system only works if the read head is used together with the 2-colored Data Matrix code tape of the following type: **PXV\*-AA25-\***.

The use of other code tapes is not permitted!

## Data Matrix Metal Code Bars

The metal code bars are an extension of the conventional code tapes and are made of robust aluminum. Compared to conventional code tapes, the metal code bars are more robust and resistant to external influences. They are specifically designed for use in environments where conventional code tapes can be quickly damaged due to the conditions in which they are used. Like conventional code tapes, the metal code bars can be glued on directly. They also have a special connection system that can be joined together like puzzle pieces. This allows the code bars to be seamlessly connected to form a continuous line.

The code bars are modular and available in nominal lengths of 100, 200, and 500 mm.



### Note

#### Observe the code bar type!

The positioning system only works if the read head is used together with the 2-colored Data Matrix metal code bars of the following type: **PXV\*-AAM-\***.

Other code bars are not permitted!

### 3.3 LED Indicators and Operating Elements

The read head has seven indicator LEDs for visual function checks and quick diagnosis.

Activate the alignment aid and parameterization mode using the two control buttons on the back of the device.

Button 1 is labeled "ADJUST." Button 2 is labeled "CONFIG."

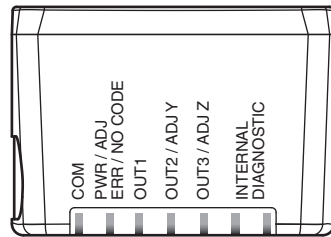
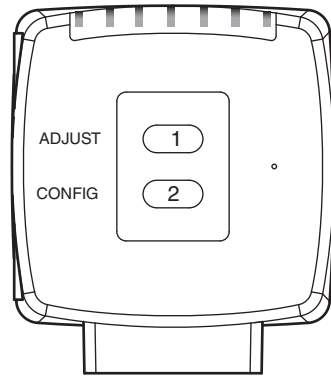

LED	[#1] COM	[#2] PWR/ADJ ERR/NO CODE	[#3] OUT 1	[#4] OUT 2/ADJ Y	[#5] OUT 3/ADJ Z	[#6] Internal diagnostics		Description
Color	Yel- low	Green/red	Yel- low	Yel- low	Yellow	Yel- low	Yel- low	
State	Off	Flashes green	Off	Off	Off	Off	Off	Orientation, Y > setpoint value $f_{\text{flash}} = 2 \text{ Hz}$
	Off	Flashes green	Off	On	Off	Off	Off	Orientation, Y < setpoint value $f_{\text{flash}} = 2 \text{ Hz}$
	Off	Flashes green	Off	Flash- ing	Off	Off	Off	Orientation, Y = setpoint value $f_{\text{flash}} = 2 \text{ Hz}$
	Off	Flashes green	Off	Off	Off	Off	Off	Orientation, Z > setpoint value $f_{\text{flash}} = 2 \text{ Hz}$
	Off	Flashes green	Off	Off	On	Off	Off	Orientation, Z < setpoint value $f_{\text{flash}} = 2 \text{ Hz}$
	Off	Flashes green	Off	Off	Flashing	Off	Off	Orientation, Z = setpoint value $f_{\text{flash}} = 2 \text{ Hz}$
	Off	Flashes red	Off	Off	Off	Off	Off	Alignment Code tape outside read range $f_{\text{flash}} = 2 \text{ Hz}$
	Off	Lights up red	Off	Off	Off	Off	Off	System error
	Off	Lights up green	x	x	x	Off	Off	Normal operation, no communi- cation LEDs marked with x indicate the status of the relevant output.
	Flash- ing	Lights up green	x	x	x	Off	Off	Normal operation, communi- cation active $f_{\text{flash}} = 2 \text{ Hz}$ LEDs marked with x indicate the status of the relevant output.
	Flash- ing	Flashes red	x	x	x	Off	Off	No code tape within read range, communication active $f_{\text{flash}} = 2 \text{ Hz}$ LEDs marked with x indicate the status of the relevant output.
	Flash- ing	Flashes red	Flash- ing	Flash- ing	Flashing	Off	Off	Normal operation. Indication for 2 secs if a button is pressed when the time lock is enabled.
	Off	Off	Flash- ing	Off	Off	Off	Off	Preconfiguration/configuration mode active $f_{\text{flash}} = 2 \text{ Hz}$
	Off	Lights up red	Flash- ing	Off	Off	Off	Off	Code card faulty $f_{\text{flash}} = 2 \text{ Hz}$ for 3 sec
	Off	Green, 1 sec	Flash- ing	Off	Off	Off	Off	Code card detected $f_{\text{flash}} = 2 \text{ Hz}$ for 3 sec
	x	Off	x	x	x	Off	Off	Time lock for buttons disabled
	x	x	x	x	x	Lights up	Lights up	Internal error Return to Pepperl+Fuchs

Table 3.1 LED Indicators

x = LED status has no meaning

### 3.4 Accessories

The right accessories offer enormous potential for cost savings. Such accessories not only save you a great deal of time and effort during initial commissioning, but also when replacing and maintaining our products.

In harsh ambient conditions, appropriate Pepperl+Fuchs accessories can be used to extend the service life of these products.

Model number	Description
PXV*-AA25-*	Data Matrix code tape
PXV*-AAM-*	Data Matrix metal code bars
PUS-F161-B28-PXV	Safe evaluation unit for position and velocity monitoring for safePUS/PXV read heads; PROFINET with PROFIsafe protocol
PUS-F161-B31-PXV	Safe evaluation unit for position and velocity monitoring for safePUS/PXV read heads; EtherCAT with FSoE protocol
V19-G-ABG-PG9	M12 single-ended female cordset, 8-pin, shielded, field-attachable
V19-G-ABG-PG9-FE	Grounding terminal and plug (set)
V19-G-BK3M-PUR-U/ABG-V19-G	Cordset, M12 socket, straight, to M12 plug, straight, A-coded, 8-pin, PUR cable, black, shielded
PCV-SC12	Grounding clip
PCV-MB1	Mounting bracket
PCV-LM25	Marker head for 25 mm code tape
PCV-AG100	Alignment guide for read head 100 mm

More information on accessories can be found in the datasheet for the read head at [www.pepperl-fuchs.com](http://www.pepperl-fuchs.com).

## 4 Transport and Storage

Retain the original packaging. Always store or transport the device in the original packaging to protect it from electrostatic discharge (ESD) and mechanical damage.



## 5 Planning

### 5.1 Position Detection – Structural Principle

The Data Matrix positioning system is an incident light positioning system consisting of a read head, the Data Matrix code tape, and a PUS evaluation unit. The read head is the central element of the system and includes a camera module with integrated lighting unit. The read head detects two-dimensional Data Matrix codes printed on a self-adhesive code tape or on metal code bars. Each individual code contains information that is made visible by a two-color red and blue LED lighting and is read by the camera. In the PUS evaluation unit, the red/blue color switching of the read head is activated, and a safe position and safe speed are calculated from the position marks detected. The prepared data is made available to the plant control system.

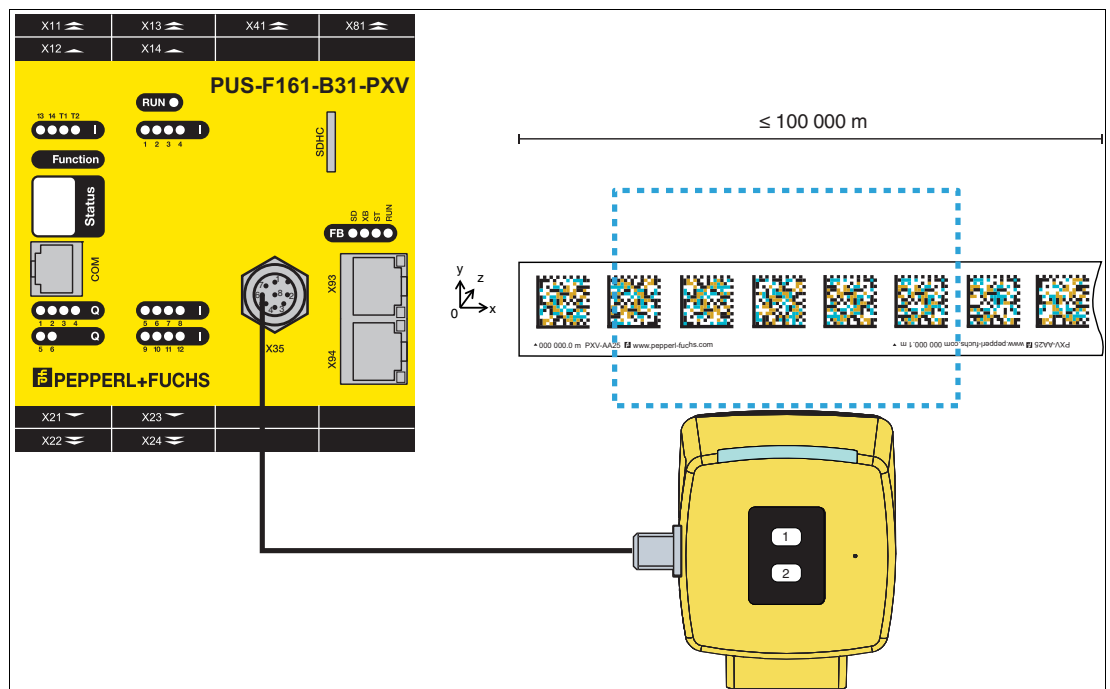

Figure 5.1 Schematic structure of the Data Matrix positioning system

### 5.2 Plant Design

Before selecting and using the product, the plant designer must evaluate whether this product is suitable for the intended application. Pepperl+Fuchs has no influence on the selection and use of this product. The warranty therefore only covers the consistent quality of the product.

Ensure that this device is used only in accordance with the technical specification described in these instructions. The device must not be used in a hazardous area.



#### Warning!

Danger due to ambiguous position information

Using double code areas can result in duplicate position information. This can lead to unclear position information. This can result in an incorrect control logic, which poses a risk to the personnel and plant.

During planning, make sure that the position information for the read head is unique in every component of the plant. Never use double code areas.

### 5.3 Safety-Related Reading Range of the Read Head

The safety-related reading range is the part of the field of view of the read head in which Data Matrix codes can be decoded. The safety-related reading range is smaller than the field of view. It must be ensured that the Data Matrix code is completely within the field of view and a quiet zone is present.

#### Field of View of the Read Head

The field of view is the maximum image on the sensor chip that is determined by the optical properties of the camera. The size of the field of view varies with the distance between the read head and the Data Matrix code tape. If the read head is positioned farther away from the Data Matrix code tape, the field of view is larger. If the read head is closer to the Data Matrix code tape, the field of view is smaller due to the shorter distance.

#### Safety-Related Accuracy

- The secure position can be determined with an accuracy of code position +/- half of the safety-related reading range.
- The safety-related reading range depends on the distance between the read head and the Data Matrix code tape and the orientation of the read head to the Data Matrix code tape.
- The accuracy changes in line with the read distance (z) to the Data Matrix code tape. The closer the sensor is to the Data Matrix code tape, the smaller the safety-related reading range and the more accurately the safety-related position can be determined.

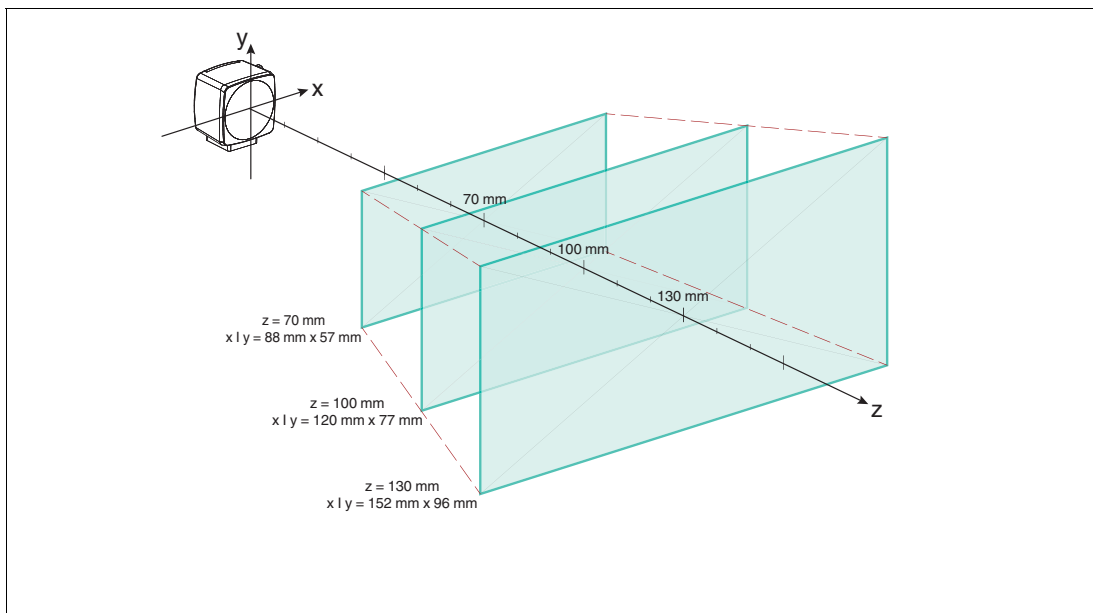

Size of the reading window in relation to the read distance z

	Read distance z to Data Matrix code tape [mm]	Reading window size x [mm]	Reading window size y [mm]	Number of Data Matrix codes in the reading window
Min.	70	88	57	max. 4
Nominal	100	120	77	max. 6
Max.	130	152	96	max. 7

## 5.4 Read Head Orientation for the Data Matrix Code Tape

The following section shows the number of visible Data Matrix codes depending on the read distance. The read head in the image is positioned in an orientation of 0° to the Data Matrix code tape.

**Number of Data Matrix codes at 100 mm read distance z to the Data Matrix code tape**

Read distance z to the Data Matrix code tape [mm]	max. number of Data Matrix codes
70	4
100	6
130	7

**0° orientation**

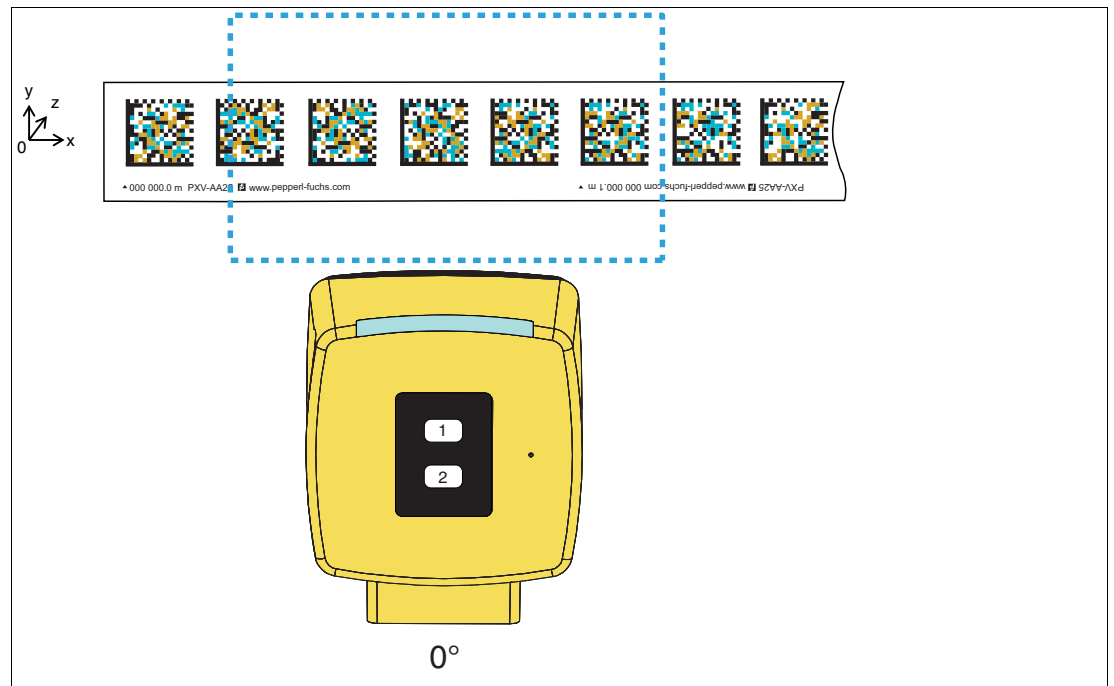

## 5.5 Characteristics of the Data Matrix Codes and Code Redundancy

### Characteristics of the Data Matrix Code

The position marks in the code tape contain information about the absolute position of the tape, and serve as reference points for the read head. The read head uses its camera to capture the image of the code and uses the information contained in the position marks to determine the exact position of the code in the camera image. This enables accurate positioning of the read head.

The code tape uses fail-safe Data Matrix codes. This is a special type of Data Matrix code (ECC200) that is encoded using the Error Correction Code (ECC) procedure. This means that it contains additional information to correct errors when reading or transmitting the code. As a result, codes can be damaged or partially obscured without the readability of the code being affected. This is especially important because in some cases the codes can be subject to a lot of wear and dirt.

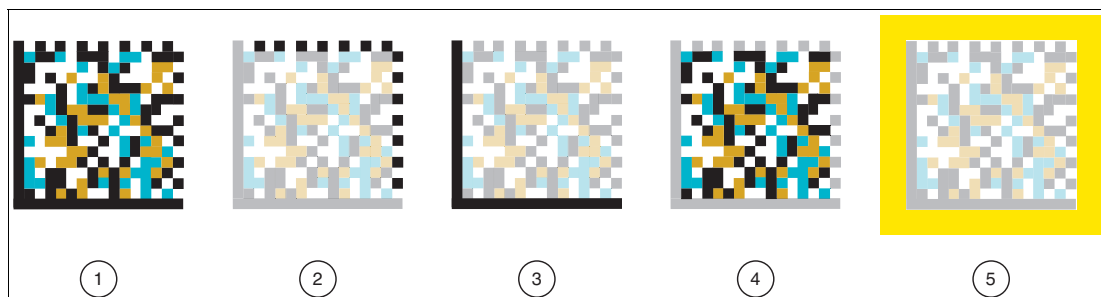

Figure 5.2 Data Matrix code ECC200

A Data Matrix code ECC200 consists of several areas that are relevant for code reading:

- 1 2-color Data Matrix codes according to ECC200
- 2 **Alternating Pattern:** The Alternating Pattern is a pattern of alternating black and white modules. The number of modules is even. It allows the data density to be determined. The Alternating Pattern is used for symbol size recognition and ECC200 type recognition.
- 3 **Finder Pattern:** The Finder Pattern is a characteristic pattern of black modules arranged in an L shape. It is used to locate the Data Matrix code in any rotation. Distortions are also detected. The Finder Pattern is used to clearly determine the location and size of the Data Matrix code.
- 4 **Data Range:** The data range is the actual data field in the Data Matrix code in which the information to be encoded is stored. It consists of a matrix of black, white, blue, and red squares representing the binary data.  
**Error correction range:** The error correction range is a portion of the Data Matrix code that contains additional data to detect and correct errors in reading and transmitting the code. The error correction range is encoded using the Error Correction Code (ECC).
- 5 **Quiet Zone:** The quiet zone (shown in yellow here) is a white area around the Data Matrix code. It is used to distinguish the code from other objects or the background. This makes it easier for the read head to read the code. The width of the quiet zone is 2 mm. To ensure that the read head can read the Data Matrix codes, the quiet zone of 2 mm around the Data Matrix code must not be violated when cutting the code tape.

### Code Redundancy

A maximum of three consecutive Data Matrix codes may be contaminated. As soon as at least one single Data Matrix code is detected in the field of view, the position output x, y can be performed. The system therefore offers the highest possible pollution tolerance, and can also be used for expansion joints or gaps (see chapter 5.7) without losing position.

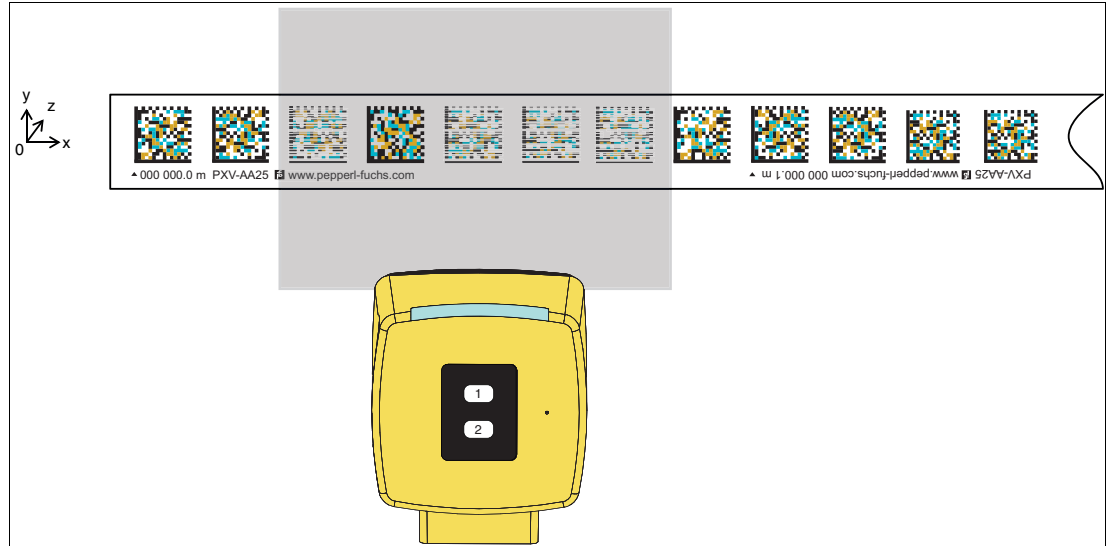
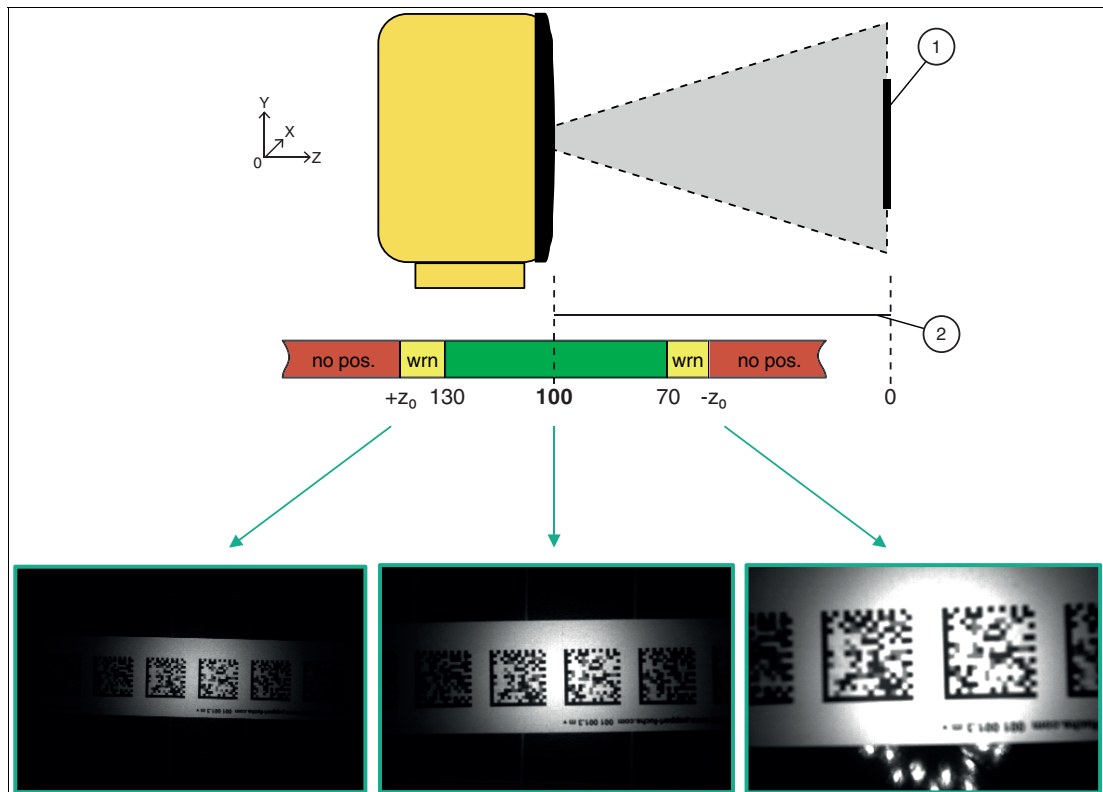

Figure 5.3

## 5.6 Read Head Orientation

### 5.6.1 Horizontal Tolerance – Read Distance $z$

The read head offers the highest possible depth of field for cornering in horizontal curves and mounting at different reading distances. If the read head is mounted too close or too far away on the Data Matrix code tape, a warning message is issued. We recommend that the read head always be mounted at a nominal distance of 100 mm, to ensure the highest possible availability of the system (due to resolution and code redundancy). Pay particular attention to the reduced mounting tolerance in the y direction and the reduced gap width, especially at extremely close reading distances.



- 1 2-colored Data Matrix code tape
- 2 Read distance to the Data Matrix code tape in z direction
- Green** Recommended reading range: Nominal value 100 mm  $\pm$  depth of focus
- Yellow** Range in which a "warning bit" is set
- Red** Range in which a "no pos. bit" is set

Read distance (z)	Range "no pos." bit	Range "warning" bit
$< -z_0$ mm	x	
$< 70$ mm		x
<b>100 mm</b>		
$> 130$ mm		x
$> +z_0$ mm	x	

### 5.6.2 Vertical Tolerance - Height Tolerance y

If the read head leaves the zero line ( $y = 0$ ) when traversing along the Data Matrix code tape (x-axis) in the y direction, a warning message is output from a defined threshold value. The read head continuously measures its position in relation to the Data Matrix code tape (1) and compares the current threshold value. If the read head is in the threshold range (shown in yellow), a warning message is issued to initiate countermeasures in time. If the error exceeds the limit value (shown in red), the read head loses the position, and a "no position" message is output.



**Note**

**Hysteresis**

The hysteresis range prevents a warning message from being repeatedly switched on and off around the limit value. If the distance in the y direction exceeds the warning limit value, the corresponding warning is activated. This message is not deactivated until the distance has fallen below the set warning limit value minus the hysteresis range.

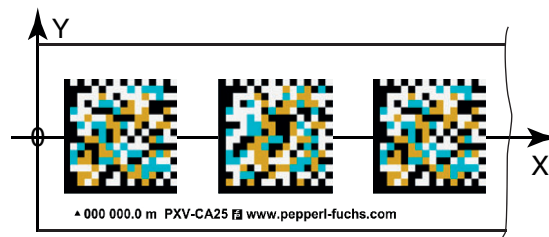

If the read head has detected a Data Matrix code tape, this Data Matrix code tape can move away from the zero point in the y direction within the field of view. The maximum y value at which the read head can still detect this distance from the zero line is set as  $+y_0$  or  $-y_0$ .

Height tolerance (y)	Range "No position message"	Range "Warning message"	Range Hysteresis
$> y_0$ mm	x		
$> 8 \geq y_0$ mm		x	
$> 7 \geq 8$ mm			x
<b>0 mm</b>			
$> -7 \geq -8$ mm			x
$> -8 \geq -y_0$ mm		x	
$> -y_0$ mm	x		

### Set Point $y = 0$

The read head is in an optimal position with respect to the Data Matrix code tape.

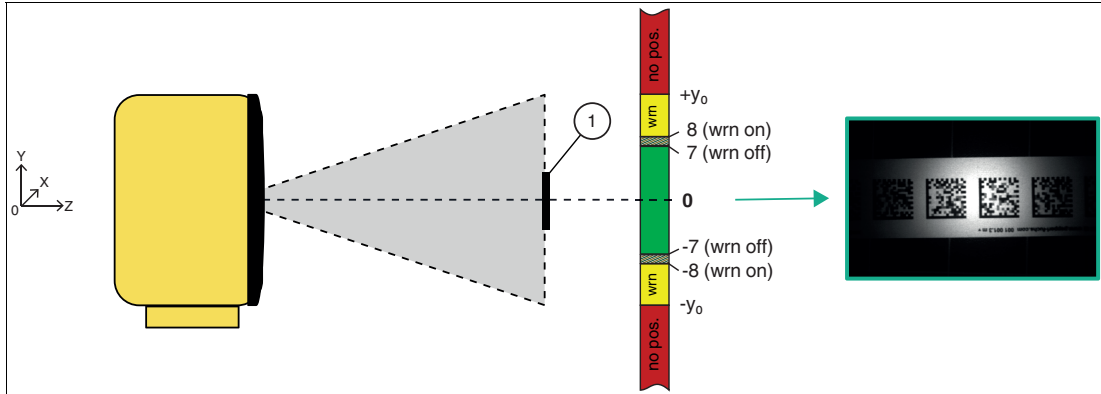

Figure 5.4 Green: recommended range

### Limit Value $y >$ Threshold Value

The read head is positioned too high in relation to the Data Matrix code tape, and a warning message is issued.

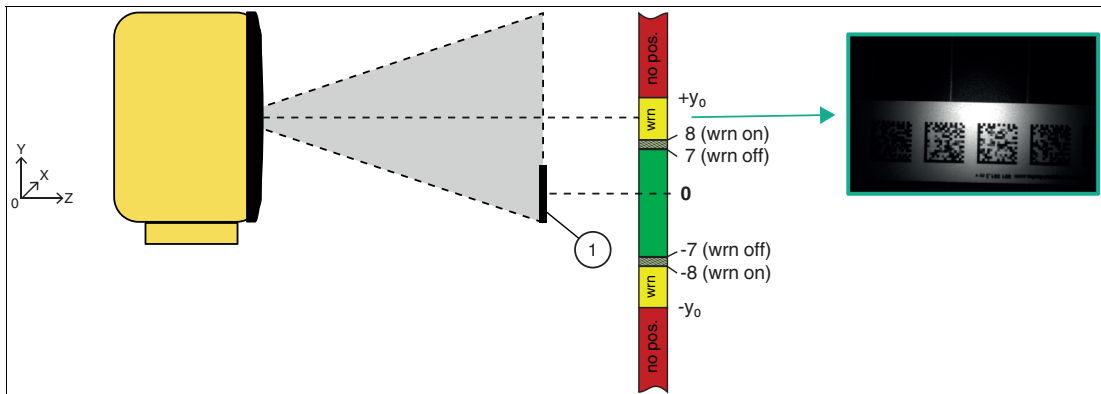

Figure 5.5 Yellow: Range in which a warning message is set

### Limit Value $y <$ Threshold Value

The read head is positioned too low in relation to the Data Matrix code tape, and a warning message is issued.

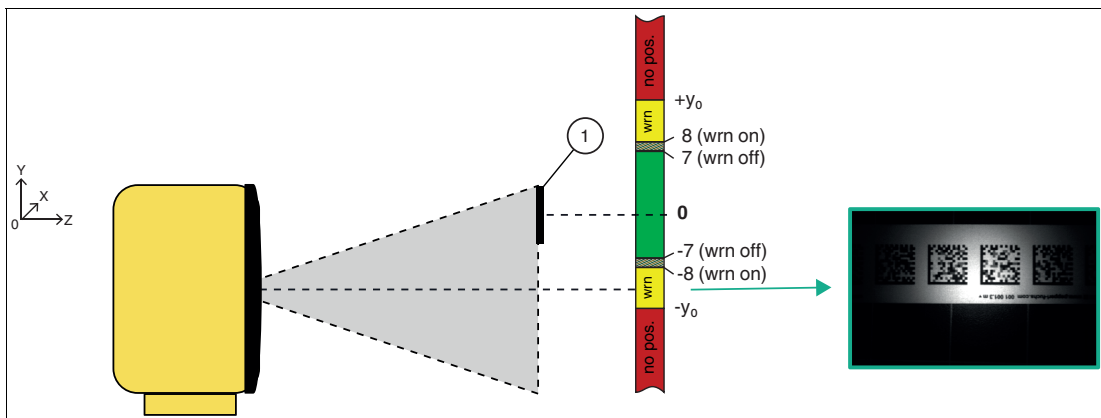

Figure 5.6 Yellow: Range in which a warning message is set



### No-Position

The read head is positioned too low in relation to the Data Matrix code tape and loses the position. The message "No-Position" is output.

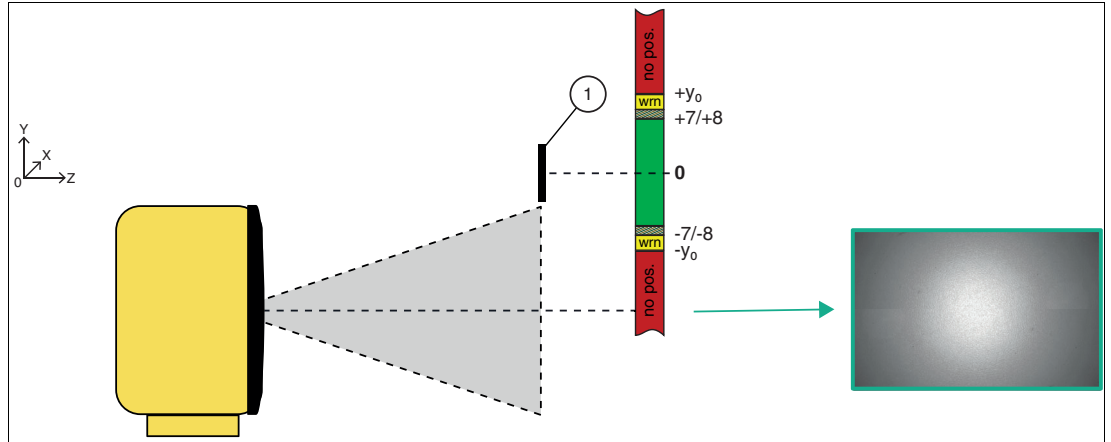

Figure 5.7 Red: Range in which a "No-position" message is set



#### Note

##### Alignment guide

Due to the alignment and mounting tolerances of the optics of the read head, the extreme values in the y direction can deviate from each other minimally. For exact alignment of the read head to the Data Matrix code tape, we recommend the use of the alignment guide (PCV-AG100).

The zero line  $y = 0$  is calibrated identically for all read heads with regard to the alignment guide. You can therefore determine the exact zero line with the help of the alignment guide when changing the read head, for example. See chapter 6.3.

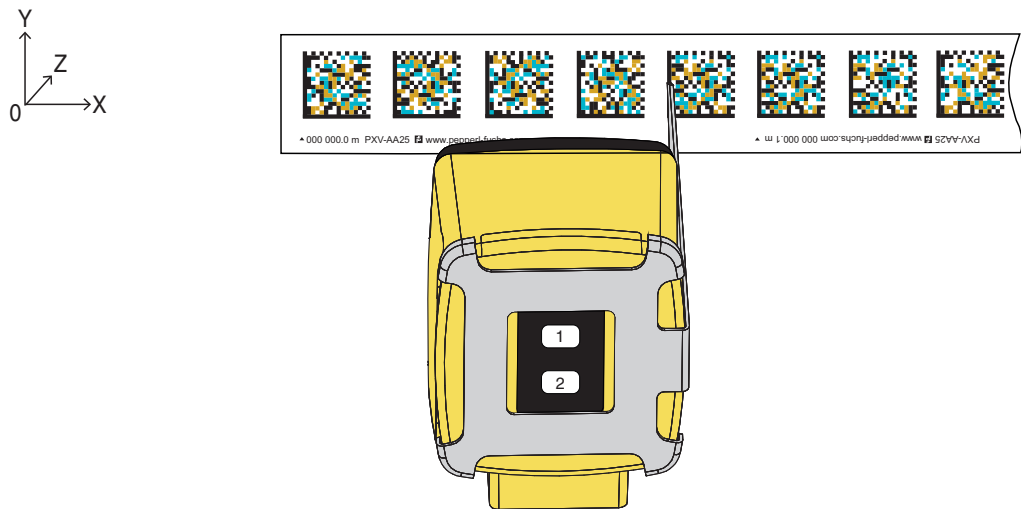

### 5.6.3 Inclination Angle

Inclination angle of  $\pm 30^\circ$  possible. It should be noted that the extreme tolerances do not apply in total.

Simultaneous tilting possible in both x and y directions.



**Note**

Simultaneous tiltings in the x and y directions are allowed. It is important to note that tilting the sensor shifts the reading window. If the sensor is tilted too much, this can cause the reading window to stop covering the Data Matrix codes.

#### Angle Tolerance on the Y Axis

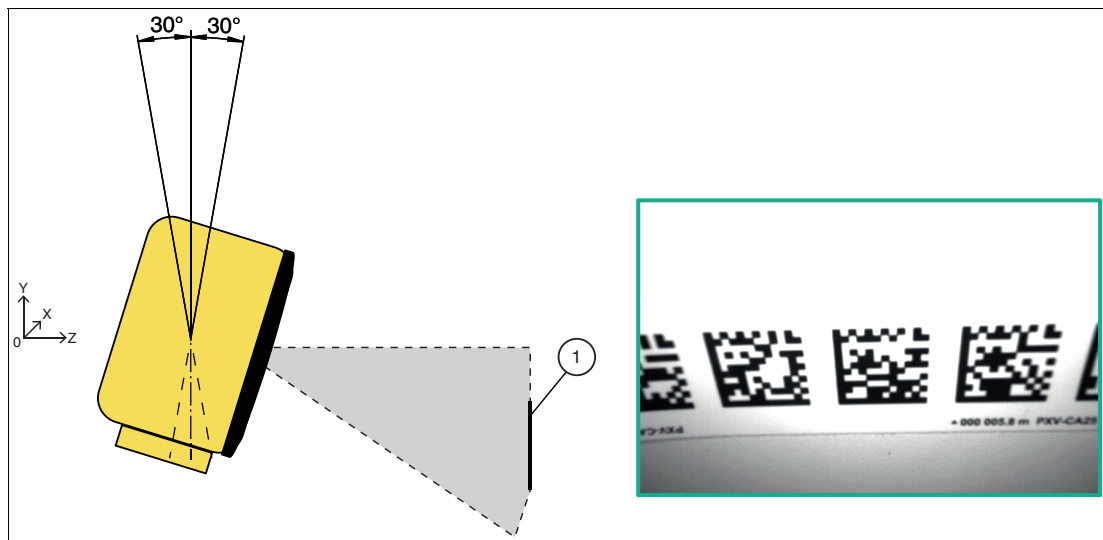

Figure 5.8 Vertical orientation tolerance

1 Data Matrix code tape

#### Angular Tolerance on the X Axis

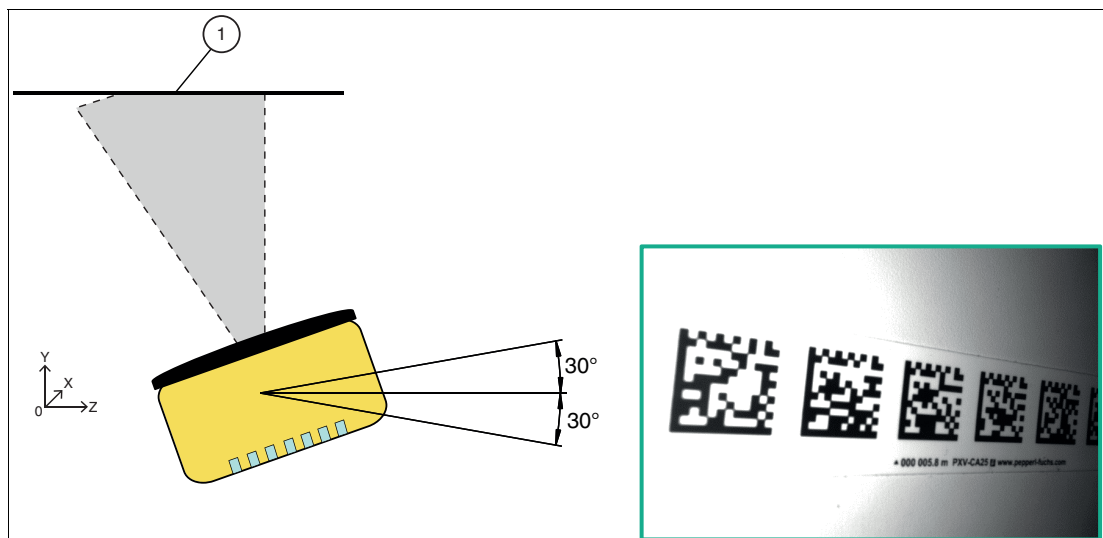

Figure 5.9 Horizontal orientation tolerance

1 Data Matrix code tape



## 5.7 Expansion Joints / Gaps

To compensate for temperature-related length changes in plant structures, expansion joints are usually required for longer tracks. If a Data Matrix code tape is applied at such locations, we recommend that you interrupt the code tape at the edge of the expansion joint and continue with a fully readable Data Matrix code tape. The read head is able to drive over expansion joints and gaps without loss of position.

The maximum gap (D) refers to the distance between two fully readable Data Matrix codes. It is therefore necessary to observe the grid of the code tape and ensure that the gaps are within the grid. The maximum gap width (D) not only depends on the reading distance, but also on the orientation of the read head.

It is therefore recommended to determine and maintain the maximum gap width based on the specific reading distance, the alignment of the read head, and the pattern of the code tape. Below are some typical values for the maximum gap width (D) depending on the read distance and the alignment of the read head.



### Note

#### Maintain the Quiet Zone!

A quiet zone (white space without coding) of 2 mm must be maintained around the Data Matrix codes. To ensure that the read head can read the Data Matrix codes, the quiet zone of 2 mm around the Data Matrix code must not be violated when cutting the code tape.

### Maximum Gap for Read Head Orientation 0°/180°

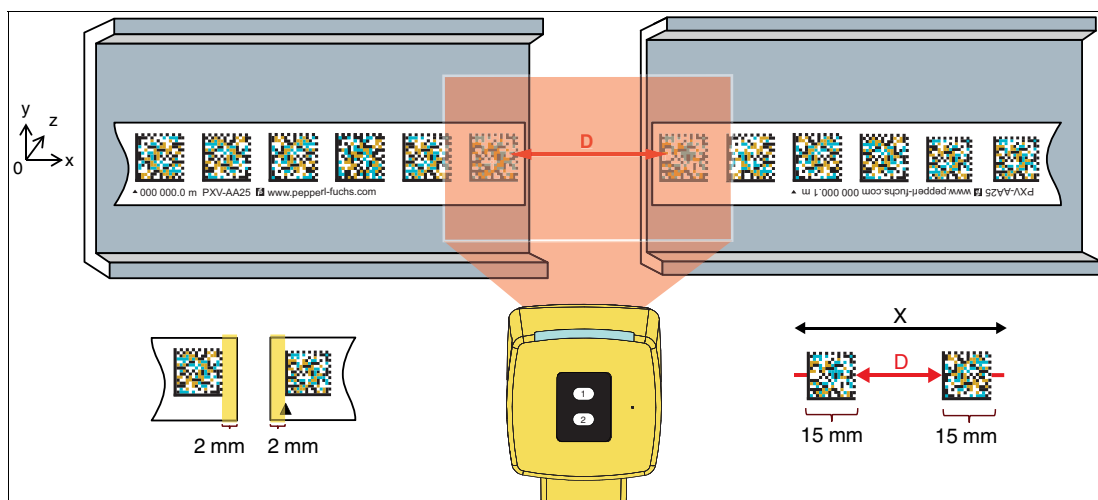

Figure 5.11



### Note

Note that the gap width D defines the distance between two complete Data Matrix codes and not the actual mechanical gap width.

### Maximum Gap Width D

	Read distance z to Data Matrix code tape [mm]	Reading window size x [mm]	Reading window size y [mm]	Max. gap width D [mm]
Min.	70	88	57	54
Nominal	100	120	77	86
Max.	130	152	96	118

2023-05

### Maximum Gap for Read Head Orientation 90°/270°

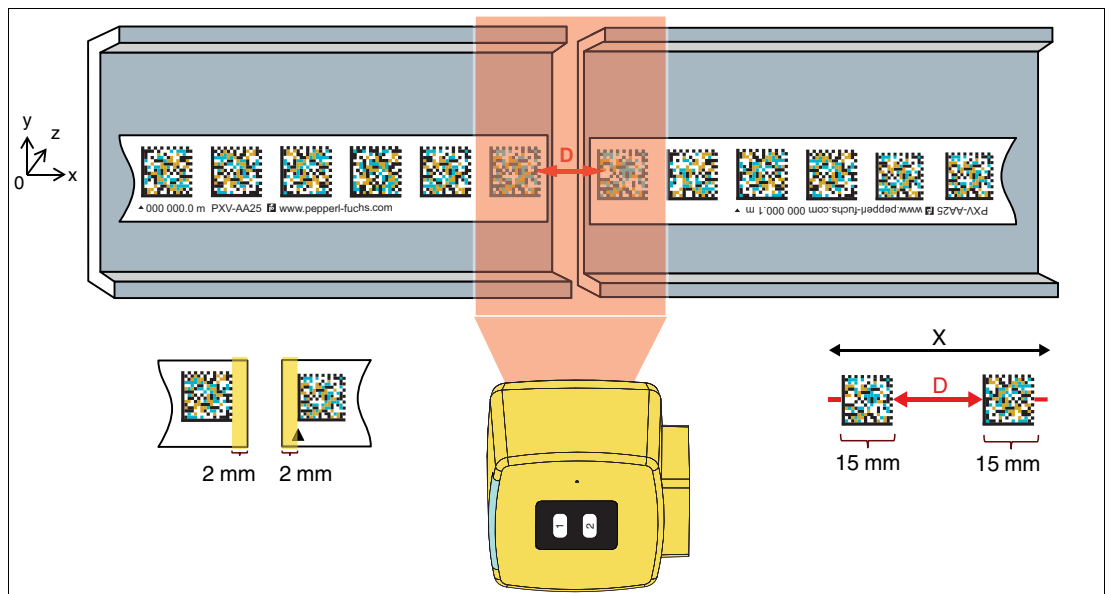

Figure 5.12 Expansion Joints / Gaps



#### Note

Please note that with this alignment of the read head, the code redundancy or the gap width is reduced.

#### Maximum Gap Width (D)

	Read distance z to Data Matrix code tape [mm]	Reading window size x [mm]	Reading window size y [mm]	Max. gap width D [mm]
Min.	70	88	57	23
Nominal	100	120	77	42
Max.	130	152	96	62

#### Examples of the Gap Width for Consecutive Missing Data Matrix Codes

The read head expects Data Matrix codes with an ascending number sequence in a predefined grid. A new code every 20 mm. This grid should be adhered to as far as possible at the interruptions to avoid position jumps.

If the code tape is cut and glued directly to the next code number, this can lead to a position jump and therefore to a high speed value. This is because the next Data Matrix code does not come after 5 mm as expected by the positioning system, but over a longer distance, the gap width.

It is therefore recommended to cut the codes according to the gap width. The quiet zone of 2 mm around the code must always be observed.

The maximum number of consecutive missing Data Matrix codes is limited and depends on various factors. In particular, the reading distance, the alignment of the read head, and the pattern of the code tape are crucial here. These factors must be taken into account when applying the Data Matrix code tape. Below are some examples of the maximum allowable gap width.

### 1 missing Data Matrix code

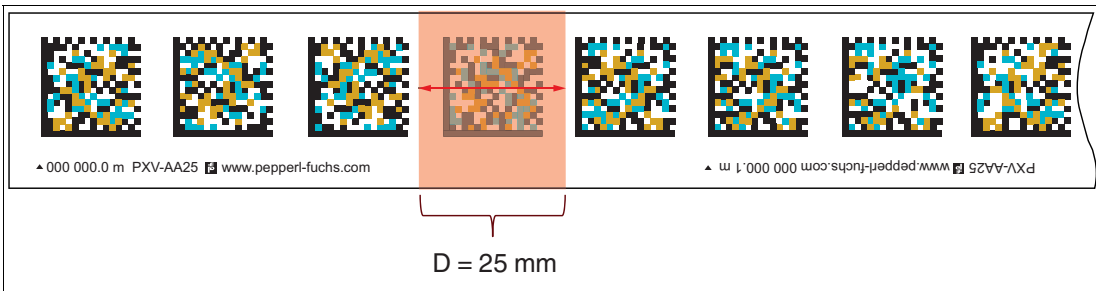

### 2 missing Data Matrix codes

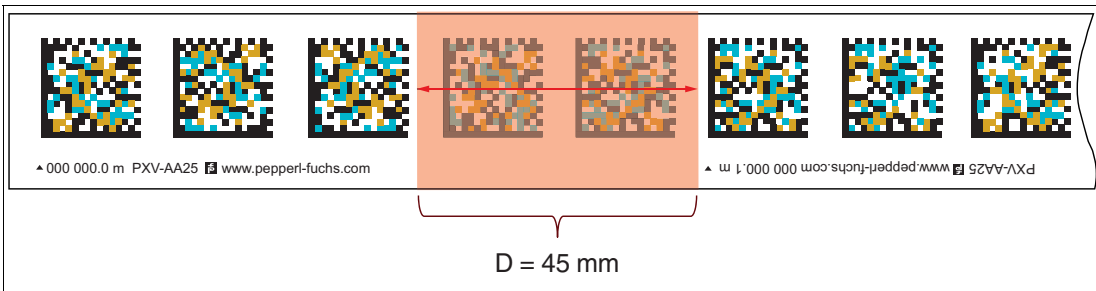

### 3 missing Data Matrix codes

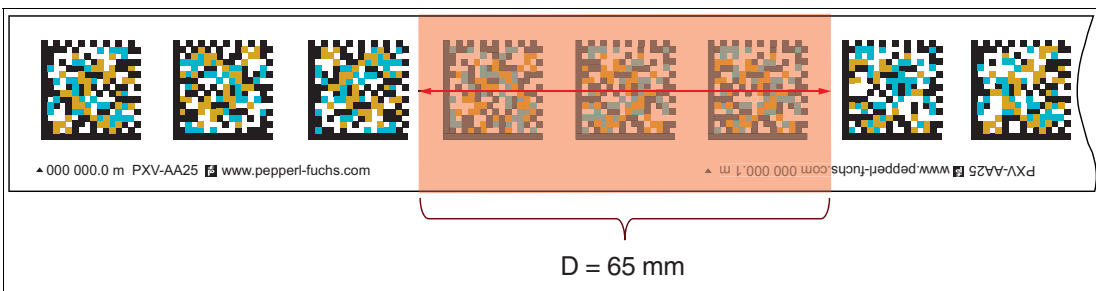

## Cutting Rule

The code tape is laid from right to left in ascending order of position, whereby the distances between the codes are defined by the pattern of the code tape.

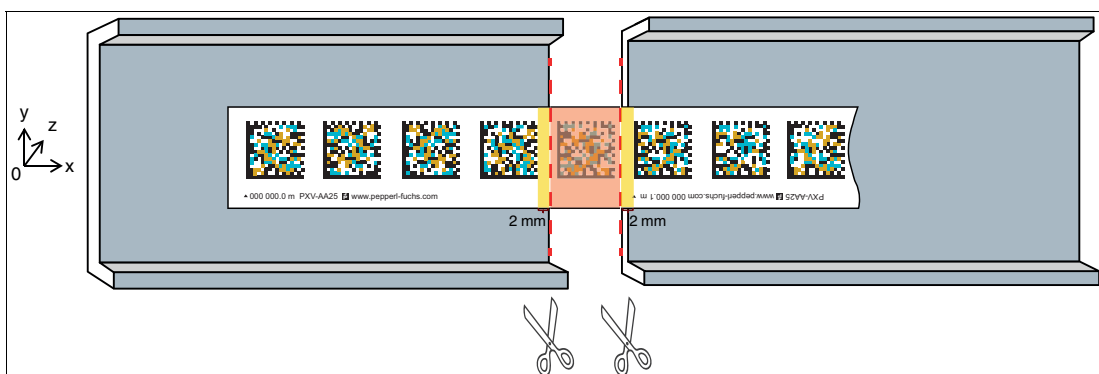

Figure 5.13

- Always cut the code tape centrally between two codes.
- In borderline situations, a projection of 2 mm of the white edge must be left.

Several methods are possible for laying the Data Matrix code tape over gaps (expansion joints or points), of which three options are shown below:

### Case 1 - Continuous Bonding

Glue the Data Matrix code tape continuously and cut out the codes in the area of the gap.

**Advantage:** The codes remain continuously in the same position grid. Therefore, there is no difference between the logical and mechanical position.

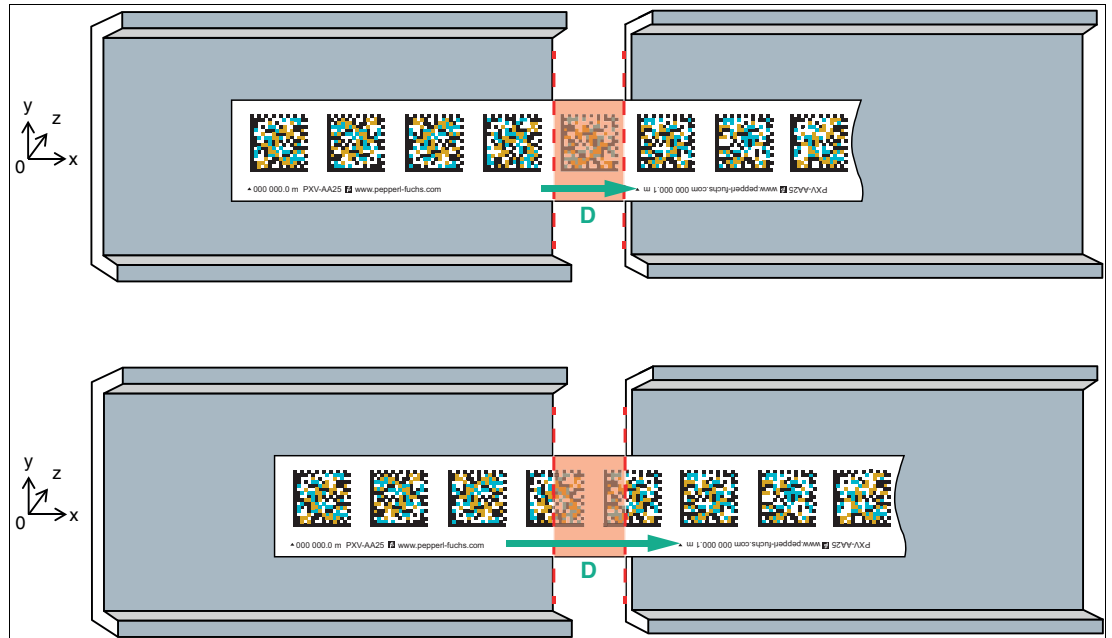

Figure 5.14

- Depending on the pattern of the Data Matrix code tape, a maximum of 1 ... 3 codes can be cut out.
- The gap condition refers to the distance D between two complete Data Matrix codes. The figure below shows that the distance D is significantly larger than in the upper figure, although the gap to be bridged is the same.
- The maximum permissible gap in relation to the selected measuring distance (z) must be observed.

### Case 2 - Continuous Continuation

Glue the Data Matrix code tape up to the gap and cut out the codes in the area of the gap. Continue the code tape at the continuous component.

**Advantage:** In the case of extremely wide gaps, the Data Matrix code tape can be optimally mounted along the mechanical gap. However, a logical jump occurs in the position value or velocity value within the transition area, because the read head expects the Data Matrix codes in a fixed grid.

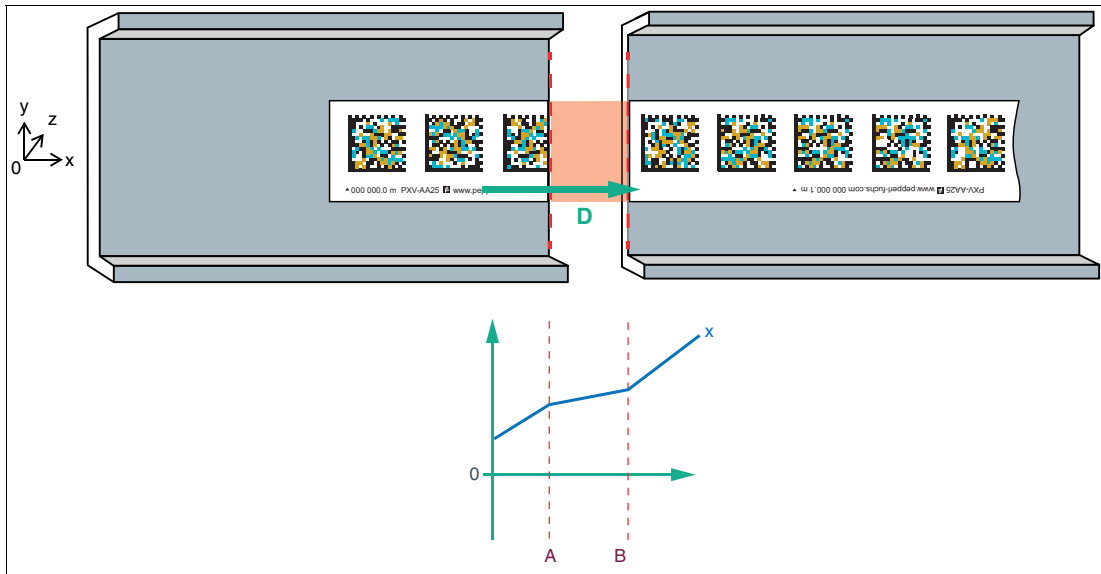

Figure 5.15

The  $x$  value is adjusted to the actual distance

### Case 3 - Continuous Continuation with Position Jump

Glue the Data Matrix code tape up to the gap/expansion gap and continue the Data Matrix code tape with a position difference of  $> 1$  meter at the continuous component.

**Advantage:** In the case of extremely wide gaps, the tape can be optimally mounted on mechanical gaps. The position jump results in a transition hysteresis, a defined position change or jump.

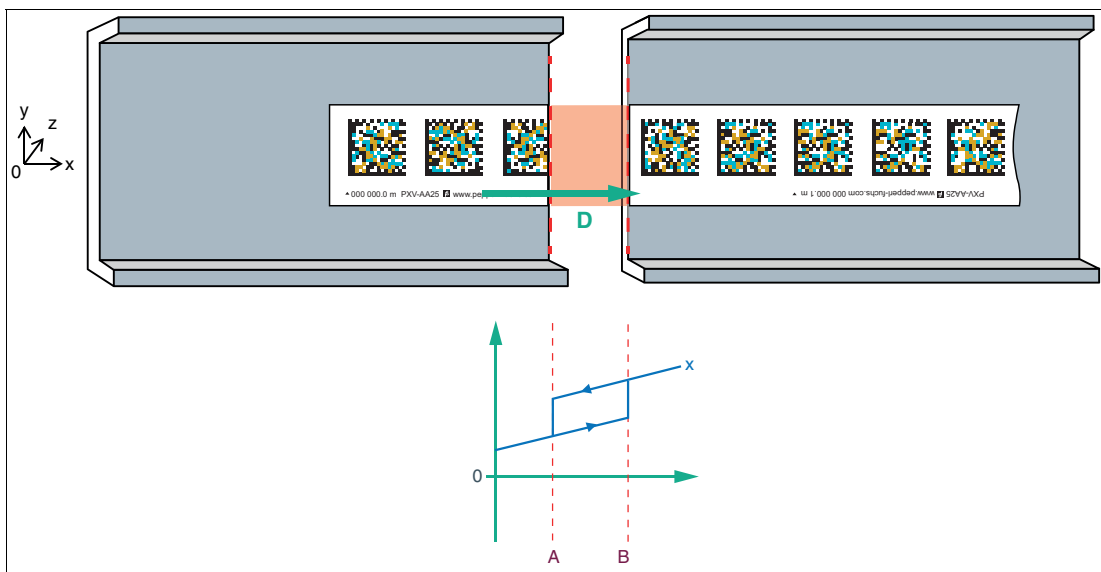

Figure 5.16



The x value remains constant at its historical value and shows a hysteresis of 21 mm. When the center of the image approaches the next code, there is a jump.

### Case 4 - Gap is too large

For a short period of time, the read head outputs the message "No Position."

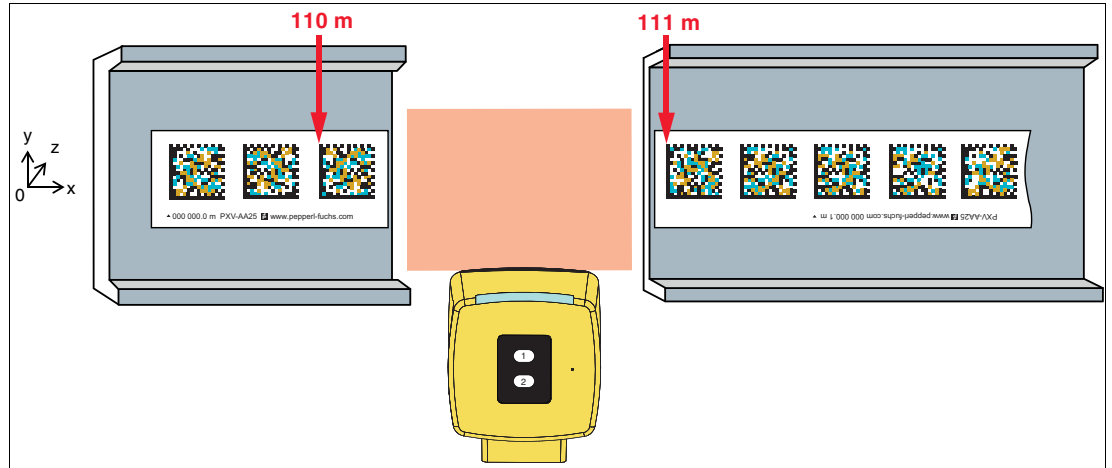

Figure 5.17

### Offset

To ensure successful detection of Data Matrix codes on a code tape, the offset  $V$  between the position codes must not be so large that the actual codes lie outside the read window. It is therefore recommended to keep the offset as small as possible.

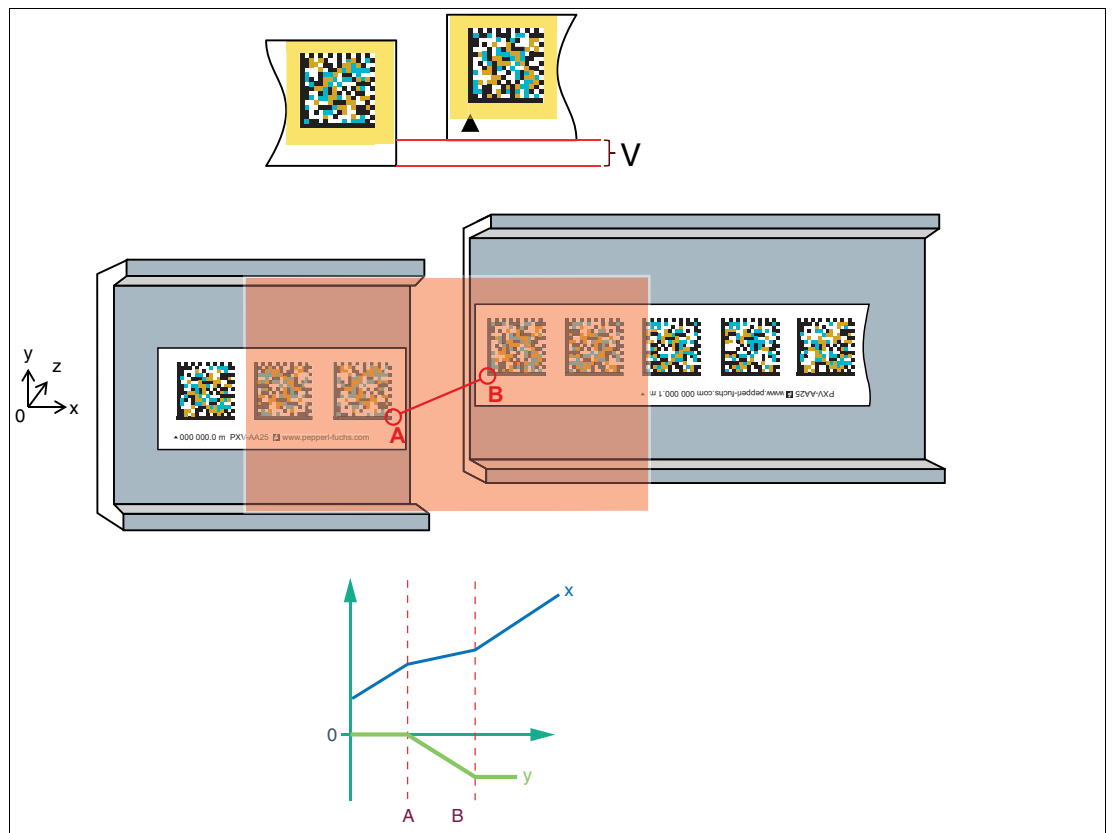

Figure 5.18 Offset

## Thermal Expansion



### Note

#### Thermal expansion coefficient

The thermal expansion coefficient of the attached code tape depends on the thermal expansion coefficient of the surface.

When planning the system, consider the worst-case scenario that can be caused by thermal expansion of the surface and adjust the Data Matrix code tape to fit the expansion joint accordingly.

One way of reducing the gap between the Data Matrix code tapes in the case of thermal expansion of the surface is to move the butt edges of the Data Matrix code tapes a few millimeters toward the expansion joint. Ensure that the Data Matrix code tapes do not overlap. The quiet zone around the Data Matrix codes of 2 mm must always be observed.

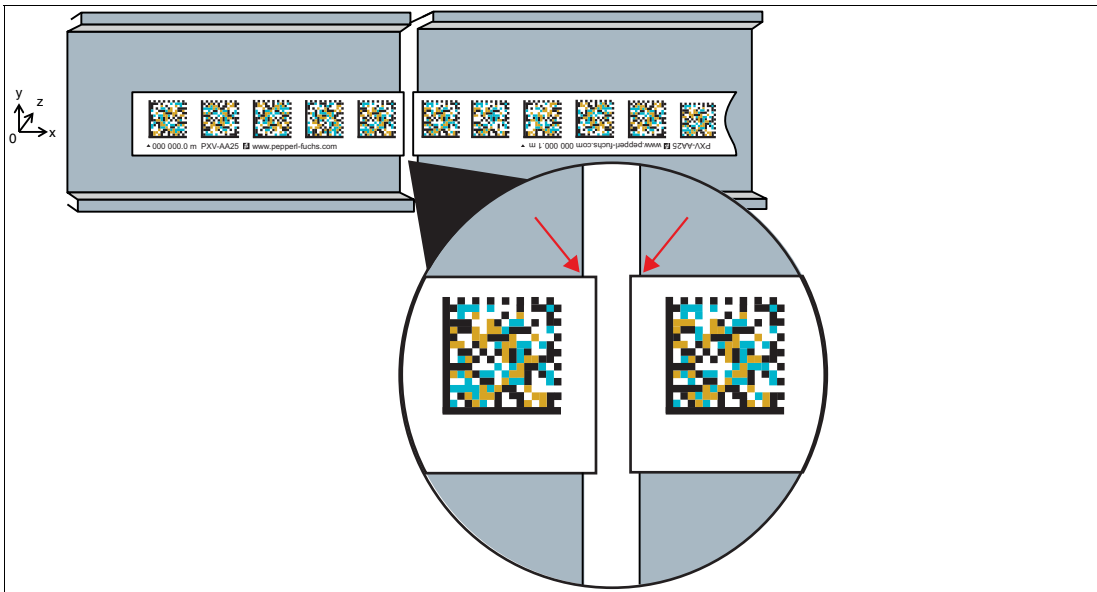

Figure 5.19

## 5.8 Behavior of the Read Head When Cornering

### Minimum Curve Radius

When planning your system, please ensure that you do not fall below a minimum bending radius of **100 mm** for horizontal curves.

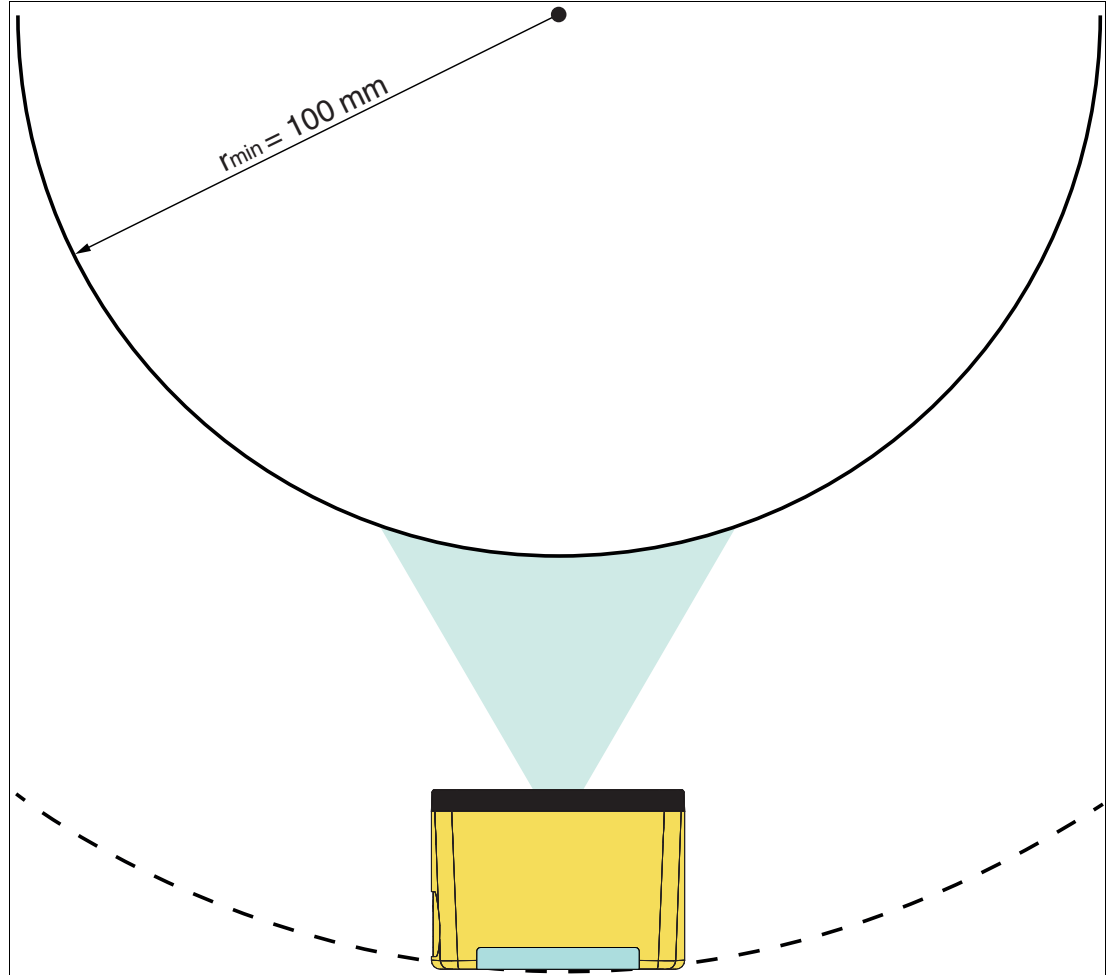

Figure 5.20

## Horizontal Curves

If the read head is not mounted in the application's axis of rotation (1), the following situation can occur for horizontal curves:

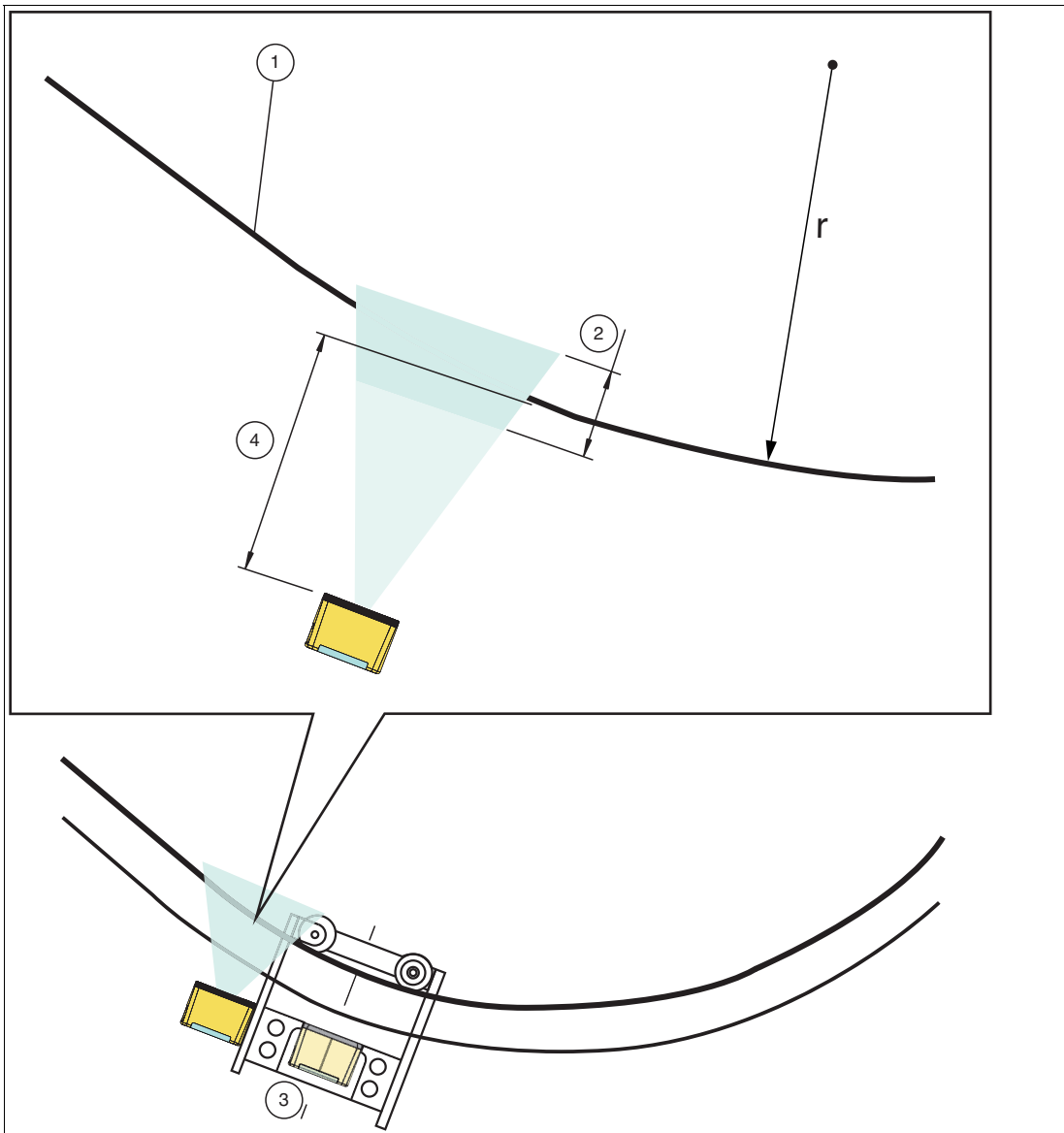

Figure 5.21

- Depending on the curve (right or left curve), the read head moves toward the code tape (1) or away from the code tape (1).
- The reading distance (4) moves out of the read head reading range. If the reading distance (4) is too large, the depth of field (2) is no longer sufficient to ensure safe position detection.
- Observe the information in the chapter "Vertical Orientation of the Read Head" ( and see chapter 5.6.3).

### Inclines and Declines

If the read head is not mounted in the rotation axis (1) of the application, the following situation may occur on inclines and declines:

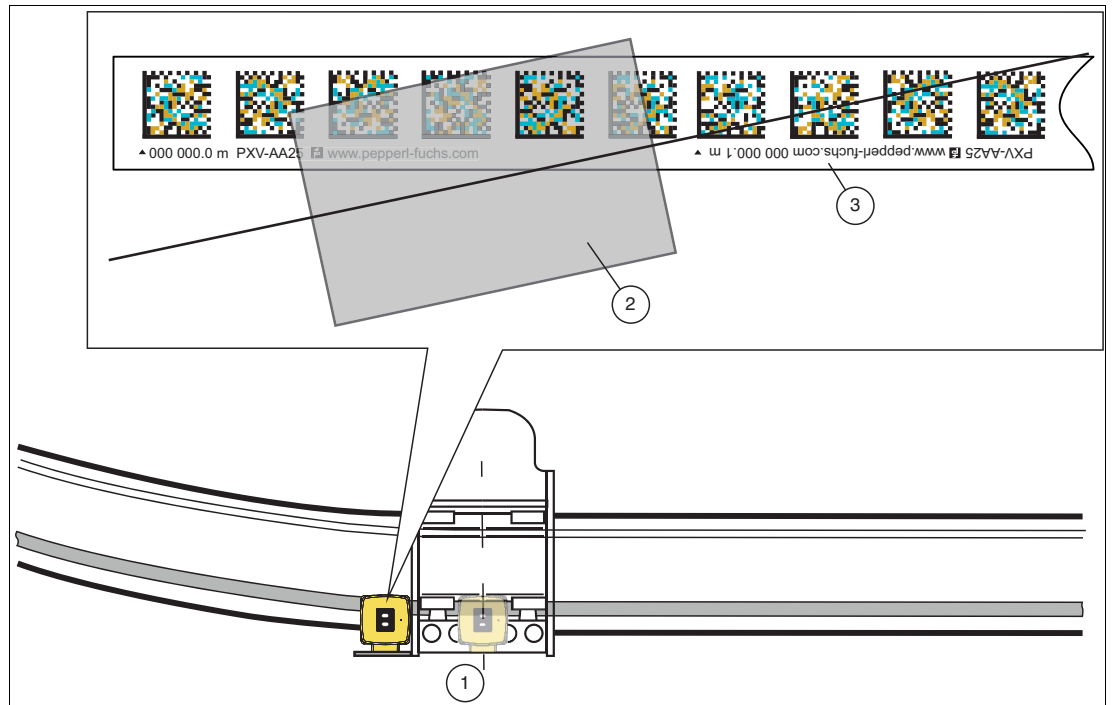

Figure 5.22

- The reading window (2) is tilted relative to the Data Matrix code tape (3). Secure position detection is only guaranteed if at least one Data Matrix code can be read.
- Observe the information in the chapter "Rotational Tolerance in the z Axis" (see chapter 5.6.4).

## 6 Installation and Commissioning

### 6.1 General

The positioning system is safe if it is mounted and set up in accordance with the provisions of these instructions, the read head works properly, and the Data Matrix code tape is mounted correctly so that it is stationary and readable.



#### Caution!

Danger due to misuse

Misuse of the positioning system can lead to dangerous situations.

- Do not use the device in hazardous areas.
- Do not make any unauthorized changes, additions or modifications to the device.
- Observe the safety information given in the product documentation.
- Observe the safety loop requirements.

### 6.2 Applying the Data Matrix Code Tape

The Data Matrix code tape is made of silicone-free polyester film. A position marker appears every 100 mm along the lower edge of the Data Matrix code tape. This position marker is used for various functions, including precise positioning of the Data Matrix code tape during mounting.

The reverse side of the Data Matrix code tape carries a modified acrylate-based permanent adhesive. Affix the self-adhesive Data Matrix code tape along the desired traverse distance.

Position the code tape so that the **www.pepperl-fuchs.com** label and the position markings are to the right of the Data Matrix code in the X direction. The position values then increase along the X direction.



#### Note

##### Note the Type of Code Tape!

The positioning system only works if the read head is used together with the 2-colored Data Matrix code tape of the following type: **PXV\*-AA25-\***.

The use of other code tapes is not permitted!

#### Dimensions of the Code Tape

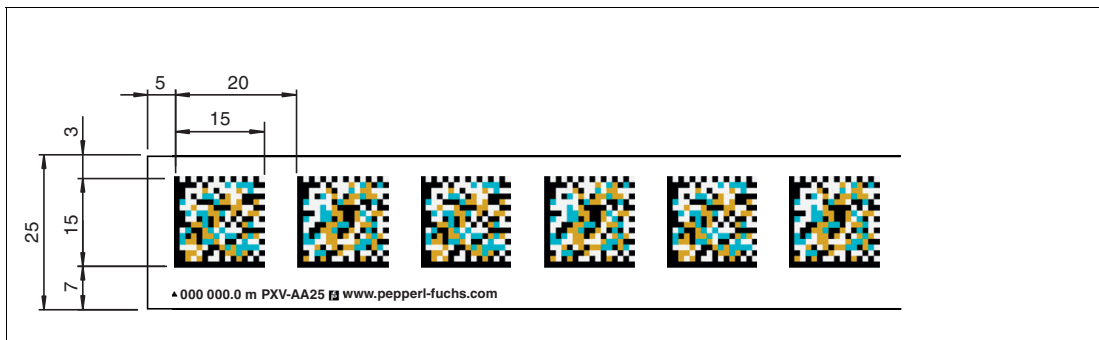

Figure 6.1 Dimension of the 2-colored Data Matrix code tape



#### Note

##### Orientation

The center of the Data Matrix code is not on the center line of the code tape.

**Note****Butt Edges**

If you attach another Data Matrix code tape at the end of a previous Data Matrix code tape, the code pattern of 20 mm must be retained.

---

**Note****Application Device**

To facilitate the application of the code tape, we recommend the use of a mechanical application device. The code tape is supplied on a roll and can be cumbersome and time-consuming to apply without a mounting aid. A mechanical application device can make the process more efficient and accurate, and avoid errors when applying.

A mechanical application device can be produced in different designs, depending on the requirements of the respective application. Typically, it consists of a mount or device that can hold and position the code tape, and a mechanism that aligns the code tape at the desired location. The mounting mechanism can be operated manually or automatically and enables quick, precise, and efficient application of the code tape.

The use of a mechanical application device can reduce the risk of errors and inaccurate positioning of the code tape. In addition, a mechanical application device can help to avoid overstretching or stretching of the code tape, which can occur when applied manually due to excessive force or uneven tension. This may result in impaired readability. A well-designed application device can ensure the uniform tension of the code tape during the application process. This contributes to a higher quality and durability of the code tape.

---

**Note****Marker head for the code tape line**

The marker head (PCV-LM25) is a useful aid to facilitate the application of the Data Matrix code tape. This device was specifically developed to mark the position of the Data Matrix code tape on the traverse distance. This ensures that the code tape is applied in the right position.

---

**Affixing Data Matrix Code Tape**

The following description outlines the basic procedure for mounting the Data Matrix code tape. Depending on the installation location, there are some points to be observed that are described in other sections of this chapter.

1. Clean the surface to remove greasy, oily, or dusty dirt.
2. Ensure that the surface is dry, clean, and stable.
3. Pull away a few centimeters of the protective film at the beginning of the code tape. Place the code tape at the precise point of the required starting position on the surface, and press to attach.
4. Then affix the code tape along the desired traverse distance. Note the following instructions.



**Note**

When removing the protective film from the code tape, make sure that the code tape is not inadvertently glued to an unwanted place. Also, ensure that no folds or waves are created in the code tape when sticking it down. The protective film should only be removed in small sections at a time.

If the protective film is removed too far, the code tape may accidentally stick in the wrong place, or form wrinkles and waves. This can make it difficult to remove and reattach the code tape in the right position.

We therefore recommend that you first remove only a small piece of the protective film and carefully attach the code tape to the desired location. If it is positioned correctly, you can further peel off the protective film to fully attach the code tape. This ensures that the code tape is positioned exactly where you want it to be and that the Data Matrix codes can be read reliably.

It is also important to ensure that the code tape does not come into contact with dirt or dust particles, as this may affect the adhesion and lead to poor adhesion of the code tape.

↳ The adhesive on the code tape hardens after 72 hours.

**Inclines and Declines**

When laying the Data Matrix code tape on inclines or declines, the Data Matrix code tape must be cut several times at the transition to the horizontal in the manner shown. Ensure that the Data Matrix codes are not destroyed and that a quiet zone of 2 mm is maintained so the Data Matrix codes are not damaged.



Figure 6.2 Inclines and Declines

- 1 Incline
- 2 Decline



### 6.3 Mounting and Alignment of the Read Head

Mounting and alignment of the read head are critical steps to ensure reliable and accurate capture of the Data Matrix codes.

The read head must be mounted in such a way that it has a clear view of the Data Matrix codes and is not obscured by other objects or machines. Stable and secure mounting is required to ensure that the read head is not moved during operation.

The alignment of the read head is another essential step in ensuring high reading accuracy of the Data Matrix codes. The position of the read head, the angle, the height, and the distance to the Data Matrix code must be considered for this.



---

#### **Warning!**

Risk of injury due to strobe effect

Stroboscopic effects when the device camera flashes can produce optical illusions, e.g., an apparent standstill or seemingly slower motion of rotating parts in the lighting. This results in a risk of injury.

Avoid mounting and aligning the device in such a way that it illuminates rotating parts. If this is not possible in parts of the plant, clearly indicate the possible hazards.

---



---

#### **Caution!**

Falsification of the image capture due to external illumination units in the mounting area of the read head

If the read head is mounted so that a second similar illumination unit with a comparable red/blue flashing behavior shines into the field of view, the recorded image can be falsified. The code of the Data Matrix code tape can no longer be decoded correctly, meaning that no valid position data is available.

When mounting the read head, make sure that no second similar illumination unit with a comparable red/blue flashing behavior shines into the field of view.

---

### 6.3.1 Mounting the Read Head

The mounting and alignment of the read head for the acquisition of Data Matrix codes requires precise fine adjustment of the read head. The mounting bracket PCV-MB1 is suitable for this purpose. It enables flexible and precise adjustment of the read head.

The slotted holes in the mounting bracket allow the read head to be moved in the y and z axes to achieve the most accurate alignment possible with the Data Matrix code tape.

Before mounting the read head, it must be ensured that the guide of the moving system part is designed in such a way that:

- The read distance is always maintained, otherwise the depth of field is no longer sufficient to ensure safe position detection (see chapter 5.6.1).
- The read head moves in the y direction in the setpoint range, otherwise a warning message is issued above a defined threshold value, or no position is detected (see chapter 5.6.2).



#### **Danger!**

Safety function failure due to inadequate mechanical mounting!

Loosening, moving, or twisting the read head can cause the programmed reference point to be shifted in relation to the tape. This can cause a shift between the programmed reference values of the safe control program and the safe position data of the read head.

The plant operator must ensure appropriate mechanical fixing. Information on a possible fault elimination for the error presumption "Detaching or Loosening a Fixing at Standstill or During Motion" can be found in DIN EN 61800-5-2:2017 Anhang D.3.16 Tabelle D.8 "Bewegungs- und Lagerückführungssensoren".



#### **Caution!**

Damage to the reader due to wrong mounting accessory

Using longer screws can damage the reader.

When selecting the length of the mounting screws, ensure that the maximum insertion depth of the screws in the threaded inserts on the reader is 8 mm.



#### **Caution!**

Damage to the reader due to inadequate attachment

If the read head is not sufficiently well and securely attached according to the requirements of the mechanical load due to the application, it can come loose and be damaged. Tightening the screws to a tightening torque that is too high can damage the reader.

Plant planners and commissioners are responsible for the following, depending on the local installation conditions:

Tightening torque of the fixing screws: Define the minimum tightening torque for installation according to the system requirement.

**Do not exceed the maximum tightening torque of 9 Nm.**

Ensure that the attachment is in accordance with the mechanical load of the application.

Prevent the unwanted loosening of connections, e.g., by using thread-locking fluid.



## Mounting the Mounting Bracket on the Moving System Part

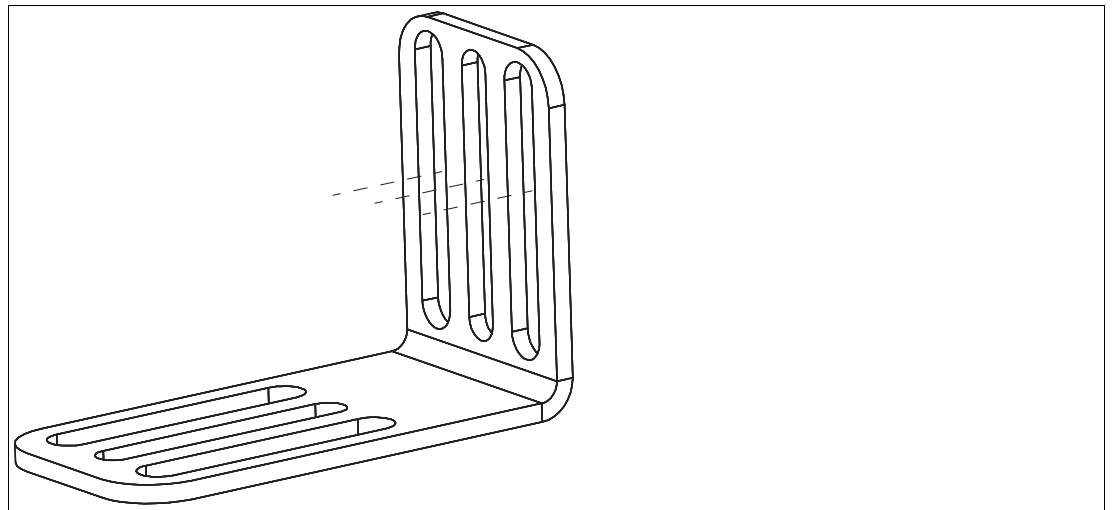

Figure 6.3 Mounting bracket (PCV-MB1)

1. Position the mounting bracket in the direction of the Data Matrix code tape so that the read head can be finely adjusted afterward.
2. Use the three slots to mount the mounting bracket. Screw the mounting bracket onto the moving part of the system using 3 screws.



### Note

#### Influence on the position determination!

It is important to check that the mounting bracket of the read head is firmly secured to ensure stable and safe mounting of the read head.

A loose or loosely mounted mounting bracket can cause the read head to be misaligned or move during operation, which can result in incorrect position values.

To check that the mounting bracket is firmly seated, carry out a visual inspection of the fasteners, such as the screws, to ensure that they are tight and secure. It may also be helpful to observe the read head during operation to ensure that it does not wobble or move.

---



## Mounting the Read Head on the Mounting Bracket



### Note

When mounting the read head, it is essential to pay attention to the direction of movement. The sensor always moves in the x direction. When mounting, ensure that the "PEPPERL+FUCHS" logo and the positioning targets are placed below the Data Matrix codes. The position values increase in the x direction.

Before installing the read head, ensure that a stable and secure mounting fixture is provided. Mount the read head so that the optics of the read head with ring light and camera module point toward the Data Matrix code tape.

1. Place the read head on the terminal block and position it in the middle. Insert the 4 mounting screws from below through the slots of the mounting bracket and through the terminal block. Tighten the screws so that the read head can still be moved on the terminal block.



### Note

The screws should not be tightened until the read head is precisely aligned. One option is to use the alignment guide, which allows the distance between the read head and the Data Matrix code tape to be precisely set. Another option is to use the alignment aid, which is activated via the "ADJUST" operating button 1 on the read head (see chapter 6.3.2).

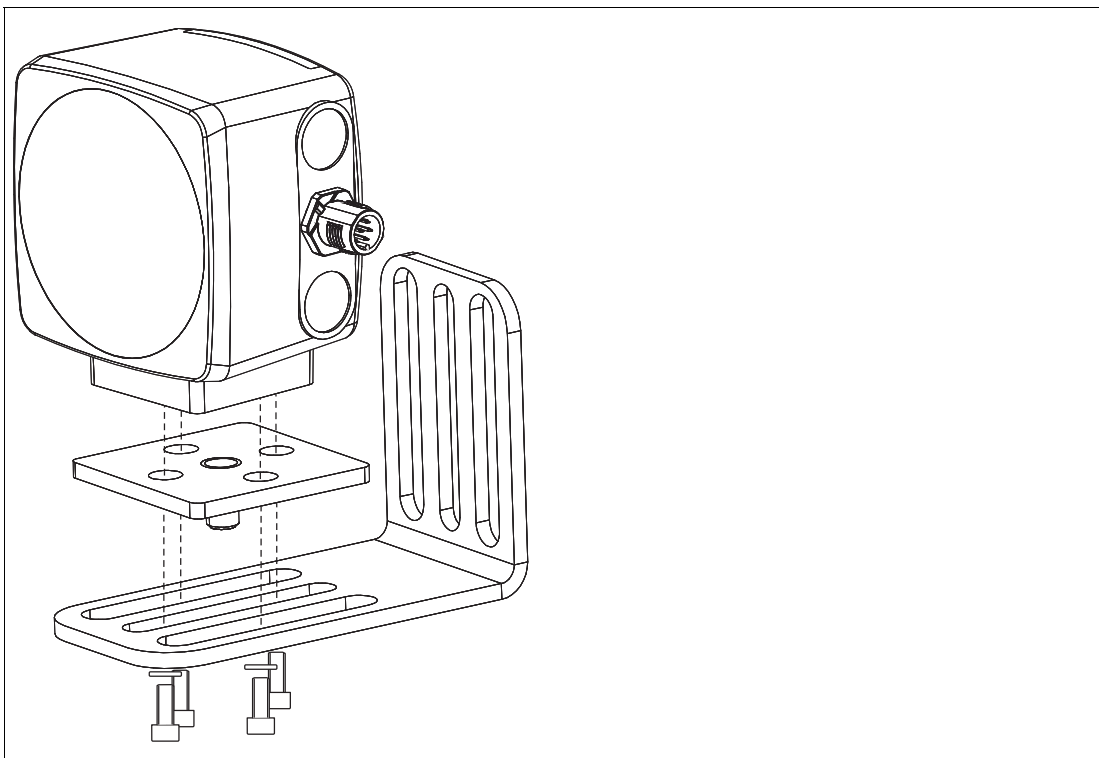

Figure 6.4 Mounting the read head



### Note

A guide pin is located in the center of the terminal block. This ensures that the read head is guided through the slots.

### 6.3.2 Alignment of the Read Head

Two tools are available for the exact alignment of the read head to the Data Matrix code tape:

- The alignment guide: It ensures the exact distance of the read head to the Data Matrix code tape, and the alignment of the optical axis of the read head to the center of the Data Matrix codes.
- The integrated alignment aid via the "ADJUST" operating button 1 on the read head: This enables fine adjustment in the y and z axes.



#### Aligning the Read Head with a Mechanical Alignment Guide

Use the alignment guide to align the optical axis of the read head with the center of the Data Matrix codes. For precise alignment of the read head with the Data Matrix code tape in the z axis, we recommend using the alignment guide PCV-AG100 (for 100 mm reading distance).

1. Adjust the distance between the read head and the Data Matrix code tape according to the information in the diagram. The optimal read distance of the read head is 100 mm with a depth of focus of  $\pm 30$  mm



#### Note

The number of readable Data Matrix codes in the reading window depends on the read distance (z distance) of the read head. The following list shows the maximum number of visible Data Matrix codes in the reading window depending on the z distance at a  $0^\circ$  orientation of the read head.

- Read distance: **70 mm**  
Number of visible Data Matrix codes: **max. 4**
- Read distance: **100 mm**  
Number of visible Data Matrix codes: **max. 6**
- Read distance: **130 mm**  
Number of visible Data Matrix codes: **max. 7**

Ensure that the conditions for the maximum gap width for expansion joints are always met (see chapter 5.7).

2. Position the read head at an orientation of  $0^\circ$  to the Data Matrix code tape. In the  $0^\circ$  orientation, the mounting adapter of the read head is directed downward.

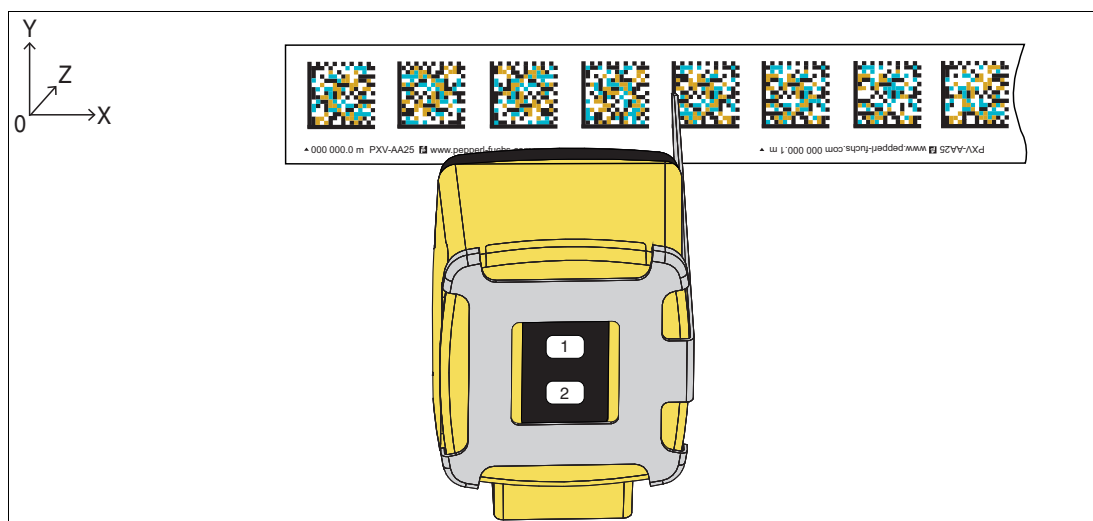

Figure 6.5 Aligning the read head

3. Insert the alignment guide over the read head from the rear. Make sure that the alignment tip of the guide sits opposite the connections of the read head.

4. Adjust the alignment of the read head until the alignment tip of the guide is aligned exactly with the center of the Data Matrix codes.
5. Note the maximum inclination angle of  $\pm 30^\circ$  on the x or y axis. Make sure that the read head is aligned within the permissible angular tolerances, see chapter 5.6.3.



**Note**

Simultaneous tilting on the x axis and the y axis is permitted. It is important to note that tilting the read head causes the reading window to shift. If the read head is tilted too much, it can cause the reading window to stop detecting the Data Matrix codes.

Using the alignment guide, the center of the optical axis of the read head can be aligned with the center of the Data Matrix codes. This ensures that the reading window detects the Data Matrix codes.

---

6. If the alignment of the read head is correct, you can tighten the 4 fixing screws on the mounting adapter of the read head.



## Aligning the Read Head with an Electronic Alignment Aid

The read head has an integrated alignment aid, which enables easy alignment of the read head in the y and z direction to the Data Matrix code tape. The alignment aid can only be activated within 10 minutes of switching on the read head.

1. Press the "ADJUST" button 1 on the read head for at least 2 seconds to activate the integrated alignment aid.  
↳ If the read head has recognized the Data Matrix code tape, LED 2 flashes green. If the read head has not recognized the Data Matrix code tape, LED 2 flashes red, see chapter 3.3.
2. Slowly move the read head in the direction (z axis) of the Data Matrix code tape until the yellow LED 5 flashes in the same cycle as the green LED 2.

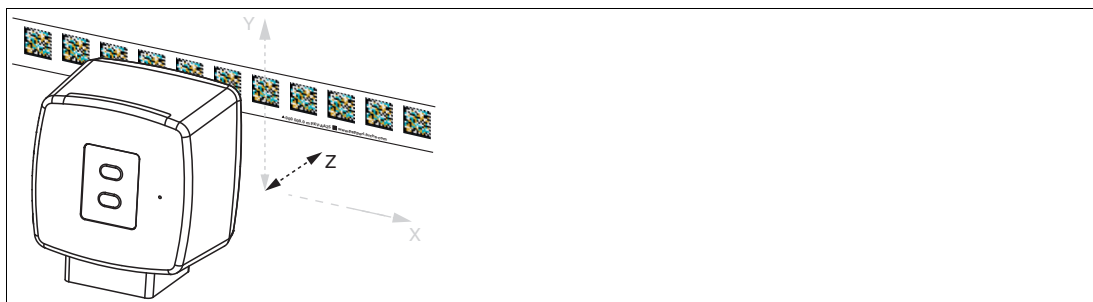

Figure 6.6 z orientation



### Note

#### z orientation:

- Distance between camera and Data Matrix code tape too small: yellow LED 5 lights up
- Distance between camera and Data Matrix code tape too large: yellow LED 5 goes out
- Distance between camera and Data Matrix code tape within the target range: yellow LED 5 flashes simultaneously with green LED 2

3. Slowly move the read head in the vertical direction (y axis) to the Data Matrix code tape until the yellow LED 4 flashes simultaneously with the green LED 2.



Figure 6.7 y orientation



### Note

#### y orientation:

- The optical axis of the read head is too low in relation to the center of the code tape: yellow LED 4 lights up.
- The optical axis of the read head is too high in relation to the center of the code tape: yellow LED 4 goes out
- Alignment of the read head in the target range: yellow LED 5 flashes simultaneously with the green LED 2

4. Terminate the alignment aid for the read head by briefly pressing the "ADJUST" button 1.  
 ↳ The read head now switches to normal operation.

## 6.4 Electrical Connection

The read head is connected electrically via an 8-pin M12 x 1 connector on the side of the housing. The power supply and communication with peripheral devices are established via this connection. The configurable inputs and outputs on the read head are located at this connection.



Figure 6.8 Electrical connection

### Connector assignment

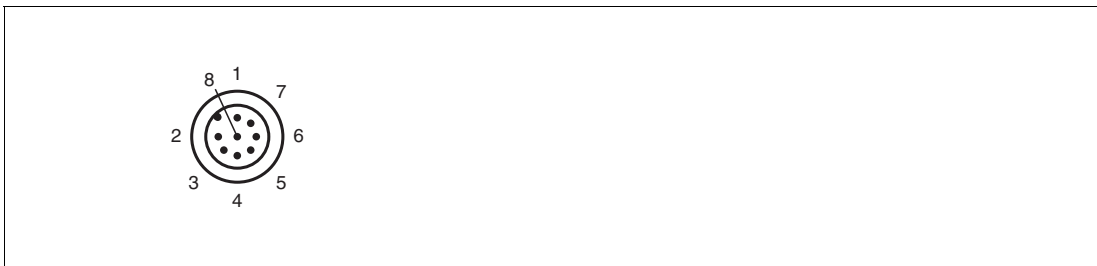

Figure 6.9 Connector assignment

### Color assignment

Pepperl+Fuchs single-ended female cordsets are manufactured in accordance with EN60947-5-2. When using a type V19-... single-ended female cordset with an open cable end ( ), the following color assignment applies:

Connection pin	Strand color	Color abbreviation
1	White	WH
2	Brown	BN
3	Green	GN
4	Yellow	YE
5	Gray	GY
6	Pink	PK
7	Blue	BU
8	Red	RD

Table 6.1 Color assignment



## Shielding Cables

The shielding of connection lines is required to suppress electromagnetic interference. Establishing a low resistance or low impedance connection with the protective conductor or equipotential bonding circuit is a particularly important factor in ensuring that these interference currents do not become a source of interference themselves. Only use connection lines with braid. Avoid connection lines with foil shield because this would increase the line capacities. The shielding is integrated at both ends, i.e., in the switch cabinet or on the PLC, **and** on the read head. The grounding terminal available as an accessory allows easy integration in the equipotential bonding circuit.

In exceptional cases, the shielding of a connection at one end may be more favorable if:

- An equipotential bonding cable is not laid or cannot be laid.
- A film shield is used.

The following points relating to shielding must be noted:

- Use metal cable clips that cover large areas of the shielding.
- Place the cable shield onto the equipotential bonding rail immediately on entering the switch cabinet.
- Direct the protective grounding connections to a common point in a star configuration.
- The cross-section of the cables used for grounding should be as large as possible.

### Additional Ground Connection

Model number	Description
PCV-SC12	Clip for mounting an additional ground connection.

Table 6.2 Ground connection



### Caution!

Damage to the device

Connecting an alternating current or excessive supply voltage can damage the device or cause the device to malfunction.

Electrical connections with reversed polarity can damage the device or cause the device to malfunction.

Connect the device to direct current (DC). Ensure that the supply voltage rating is within the specified device range. Ensure that the connecting wires on the female cordset are connected correctly.

## 6.5 Connecting the Read Head to the PUS Evaluation Unit

This chapter is intended to provide a simplified overview of the connection of the safePXV/PUS read head to the PUS evaluation unit.



### Warning!

Read the information in this documentation carefully and observe the information in the Installation Handbook for the PUS evaluation unit.

The PUS evaluation unit has an M12 socket for connecting a read head.

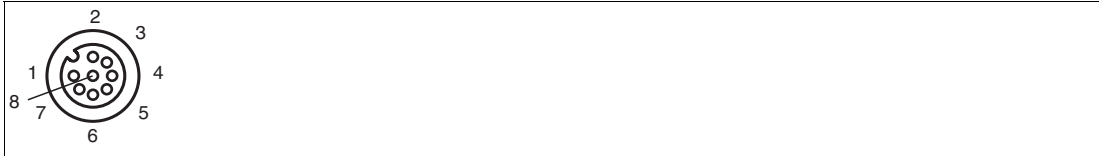

### Interface on the PUS Evaluation Unit

Interface	Pin	Designation	Description
X35 M12 socket, 8-pin	1	I/O2 (enable blue)	Activation of blue lighting
	2	UB+	Supply voltage
	3	Data + / TX / 485+	Data transfer
	4	Data - / RX / 485-	Data reception
	5	O1 (sync. out)	SYNC signal of the read head
	6	I1 (enable red)	Activation of red lighting
	7	GND	Ground
	8	I/O3	Not used

### Note



#### Two-sided grounding

The shielding of cables is required to suppress electromagnetic interference. Please use only shielded, twisted-pair cables, and shielded plugs with grounding.

The shielding is integrated at both ends, i.e., in the PUS evaluation unit and on the read head. The grounding terminal (PCV-SC12) available as an accessory allows easy integration in the equipotential bonding circuit.



### Establishing a Connection

To connect the read head to the PUS evaluation unit, proceed as follows:

1. Connect the M12 connector plug of the read head to the M12 socket of the PUS evaluation unit (X35).
2. Make sure that the connector plug is firmly and securely seated.

## 6.6 The RS-485 Interface

The read head is equipped with an RS-485 interface for communication purposes, i.e., parameterizing the read head functions or reading out current process data during operation. This interface is operated in 8-E-1 operating mode and is fitted with a terminator that can be activated or deactivated by parameterizing the sensor head. The RS-485 interface supports the following transfer rates:

- 38400 bit/s
- 57600 bit/s
- 76800 bit/s
- **115200 bit/s** (default value)

### Data structure of the RS-485 interface

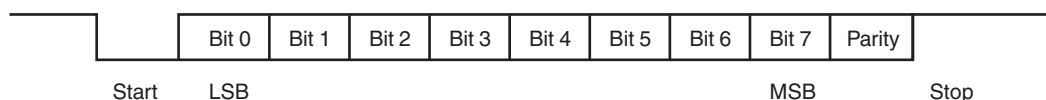

### Description of Sensor Data

#### Sensor Data

Pb	Position data for calculating the safe X position
ERR	Error message status bit present, error number in XP data
NP	No position information status bit
WRN	Warning present
XP	X fine position; resolution 1 mm
SP	Speed; resolution 1 mm/s
DIA	Diagnostic data/quality grade

#### Warning messages

Warning code	Description	Priority
0	No further warnings are present. This code is returned when all warnings have been read.	-
9	Temperature too high	1
8	Repair tape detected	2
1	Code with non-PXV content found	3
2	Read head too close to code tape	4
3	Read head too far from code tape	5
4	Y position too large; the sensor is just before OUT	6
5	Y position too small; the sensor is just before OUT	7
6	The read head is rotated or tilted in relation to the code tape	8
7	Low level of code contrast	9

### Quality Grades

The permanent monitoring of the quality grades enables an early reaction to damage or contamination of the code tape or the camera during commissioning and during operation. This increases the overall operational safety and in the case of a fault, the problem can be localized immediately. The quality is assessed using a scale of 1 to 6, with 1 being the best reading quality. If the grade is 3 or worse, a check of the camera or distance should be performed. Grade 7 signifies "No position" because no code was detected.

## 6.7 Commissioning the Read Head with the PUS Evaluation Unit via safeControl Expert

This section provides a brief description of the commissioning of the read head with the PUS evaluation unit via the safeControl Expert configuration software.



### Note

Please note that this brief description is only a summary of the necessary steps and does not cover all details and options. For more information and detailed instructions, we recommend that you read the safeControl Expert configuration software manual.



### Perform Commissioning with safeControl Expert

1. Download the safeControl Expert software from the Pepperl+Fuchs website and follow the installation steps.

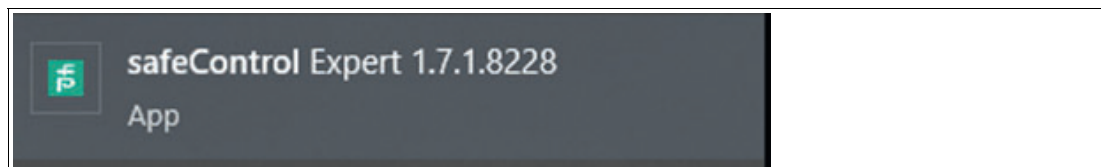

Figure 6.10



### Note

#### Dongle

For the correct operation of safeControl Expert, you need a license dongle (PUS-USB-LICENSE, item number: 70150045). If the program is started without a dongle, the following message appears:

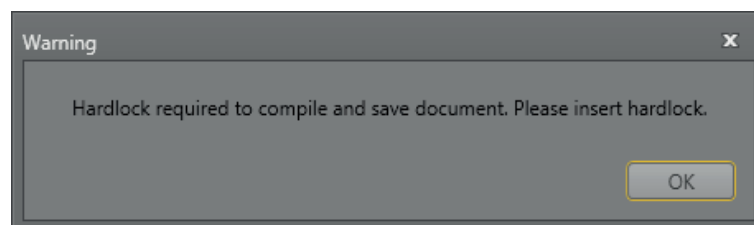

Figure 6.11

Click "OK" and insert the license dongle into the USB port. The dongle is automatically detected and safeControl Expert can be used in its full range of functions. If the dongle is removed while working with safeControl Expert, the full range of functions is no longer available, and the created program cannot be compiled and saved. Plug the dongle back into the USB port to restore full functionality.

2. Create a new, empty project by clicking the "New" button on the main menu.  
↳ An empty work area is displayed. All available devices are included in the library.

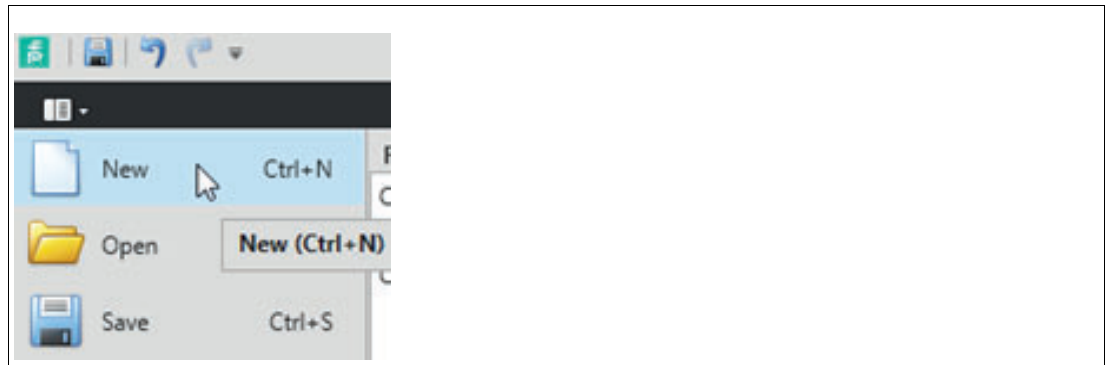

Figure 6.12

3. Select the PUS evaluation unit "PUS-F161-X-PXV" from the library and drag and drop it into the "Connection diagram" [Terminal Scheme].

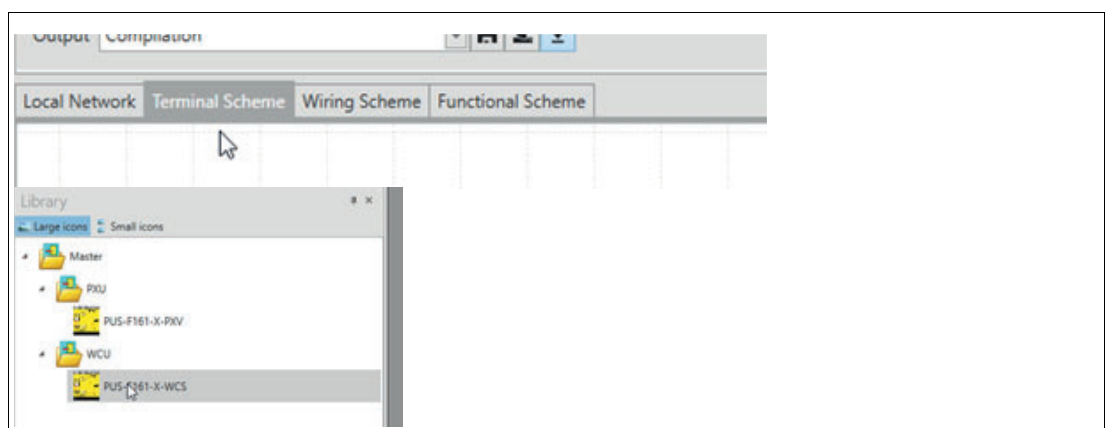

Figure 6.13

4. Open the properties window of the PUS evaluation unit and select the configuration "PXV" (1) under "Encoder Combination - Axis 1."

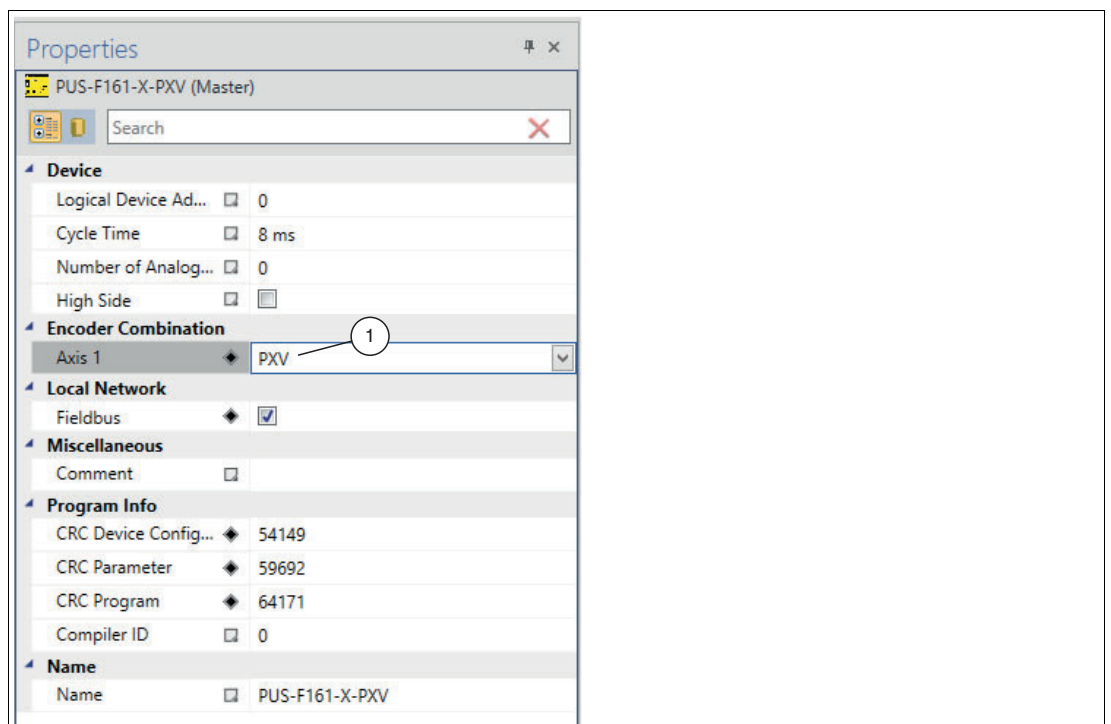

Figure 6.14

- Switch to the "Function plan" tab (1) and drag and drop axis 1 with PXV read head (2) into the function plan.

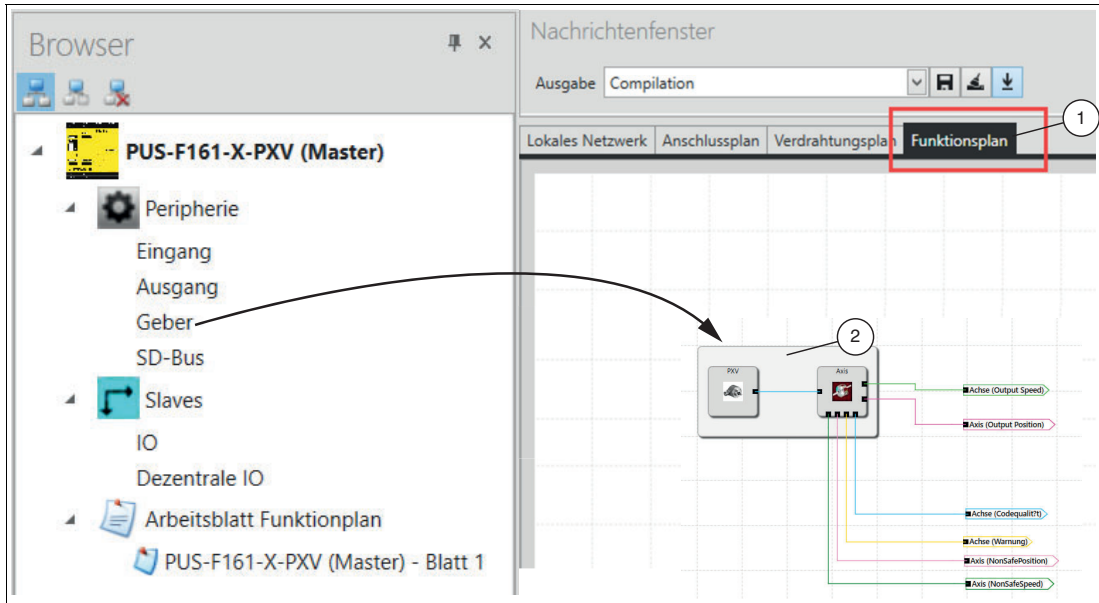

Figure 6.15

- Configure the axis settings according to your requirements.

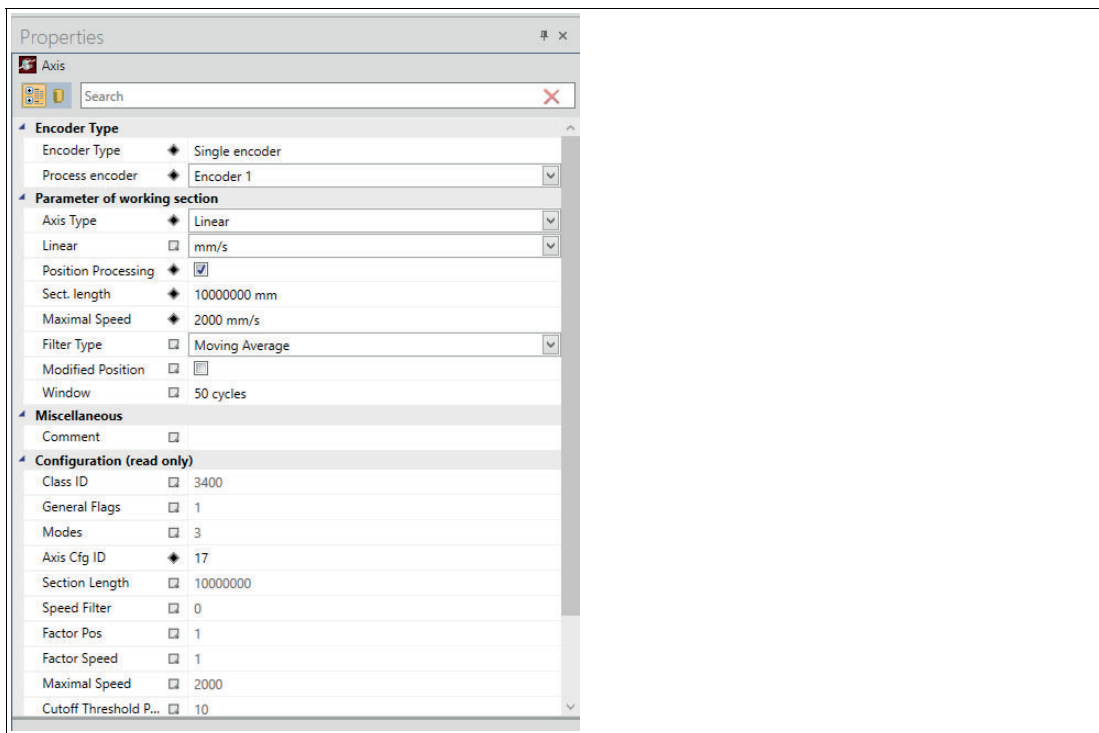

Figure 6.16



**Example**

- Axis type: Linear
- Unit [Linear]: mm/s
- Position Processing: Enable for safe position signal (position monitoring)



---

**Note**

For more information on the individual values, refer to the safeControl Expert manual.

---

## 7 Maintenance



### Caution!

Gerät kann bei längerer Betriebsdauer warm werden

Nach längerer Betriebszeit weisen die Metallflächen (Stecker) und das Gehäuse des Sensors eine erhöhte Temperatur zur Umgebung auf.

Dies ist bei Servicearbeiten zu beachten. Lassen Sie das Gerät abkühlen, bevor Sie es handhaben.

If the read head is faulty, it must be replaced with a new device. The read head may not be repaired.

No position values can be determined wherever sections of the Data Matrix code tape are dirty or destroyed.



### Note

#### Replacing Damaged or Destroyed Data Matrix Code Tape

The operator is responsible for replacing dirty or destroyed sections of Data Matrix code tape with original Data Matrix code tape. Replacement sections can be obtained from Pepperl+Fuchs, .



### Maintaining, Repairing or Replacing the Device

In case of maintenance, repair or replacement of the device, proceed as follows:

1. Implement appropriate maintenance procedures for regular maintenance of the safety loop.
2. While the device is maintained, repaired or replaced, the safety function does not work. Take appropriate measures to protect personnel and equipment while the safety function is not available. Secure the application against accidental restart.
3. Do not repair a defective device. A defective device must only be repaired by the manufacturer.
4. If there is a defect, always replace the device with an original device.

### 7.1 Maintenance

The device is maintenance-free.

### 7.2 Testing

The device does not need to be tested. To ensure adequate availability, we recommend regularly examining the read head and the Data Matrix code tape for mechanical damage and removing contamination.

A regular proof test is not required since the minimum interval for a proof test is longer than the useful lifetime. If the device is subjected to sources of potential mechanical damage or vibration in the plant, we recommend regularly inspecting the device with regard to the integrity of the housing (water ingress) and the right fastening (loose mounting screws).



## 7.3

### Cleaning

---

**Caution!**

Material damage due to improper cleaning

Treating surfaces with the wrong cleaning agents and liquids can damage the surface and therefore disrupt the function of the read head or make the Data Matrix codes illegible.

---

#### Cleaning the Read Head

Check that the components are securely mounted and that optical surfaces are clean.

Regularly clean the surface of the read head lens. The cleaning interval depends on the ambient conditions and the climate within the plant.

Use a soft, lint-free cloth to clean the surfaces.

#### Cleaning the Data Matrix Code Tape

The surface of the Data Matrix code tape consists of a polyester film with a special matt surface for diffuse reflection. The use of incorrect cleaning agents, or constant brushing can lead to the risk of the matt surface of the Data Matrix code tape being polished smooth. If the Data Matrix code tape has a shiny surface, this impairs detection of the codes by the read head. To avoid polishing the surface, do not apply strong pressure when cleaning the Data Matrix code tape.

Only use a non-aggressive plastic cleaner such as Caramba® to clean the code tapes.

---

**Note**

We do not recommend the use of conveyor brushes or permanent cleaning systems. These can damage the surface of the code tapes and make the Data Matrix codes unreadable.

---

## 7.4

### Repairs

---

**Danger!**

Danger to life due to missing safety function

If the safety loop is taken out of operation, the safety function is no longer guaranteed.

Do not bypass the safety function.

---

Do not repair or manipulate the device.

If there is a defect, always replace the device with an original device.

Only use accessories specified by the manufacturer.

## 8 Disposal

The device, built-in components, packaging, and any batteries contained within must be disposed in compliance with the applicable laws and guidelines of the respective country.

# Your automation, our passion.

## Explosion Protection

- Intrinsic Safety Barriers
- Signal Conditioners
- FieldConnex® Fieldbus
- Remote I/O Systems
- Electrical Ex Equipment
- Purge and Pressurization
- Industrial HMI
- Mobile Computing and Communications
- HART Interface Solutions
- Surge Protection
- Wireless Solutions
- Level Measurement

## Industrial Sensors

- Proximity Sensors
- Photoelectric Sensors
- Industrial Vision
- Ultrasonic Sensors
- Rotary Encoders
- Positioning Systems
- Inclination and Acceleration Sensors
- Fieldbus Modules
- AS-Interface
- Identification Systems
- Displays and Signal Processing
- Connectivity

### Pepperl+Fuchs Quality

Download our latest policy here:

[www.pepperl-fuchs.com/quality](http://www.pepperl-fuchs.com/quality)

