

VisuNet Computing Unit

TCU1100-*/TCU1200-
PCU1100-*/PCU1200-*

Elkhart Lake Processor
Series

Manual



With regard to the supply of products, the current issue of the following document is applicable:
The General Terms of Delivery for Products and Services of the Electrical Industry, published
by the Central Association of the Electrical Industry (Zentralverband Elektrotechnik und Elek-
troindustrie (ZVEI) e.V.) in its most recent version as well as the supplementary clause:
"Expanded reservation of proprietorship"

Worldwide

Pepperl+Fuchs Group
Lilienthalstr. 200
68307 Mannheim
Germany
Phone: +49 621 776 - 0
E-mail: info@de.pepperl-fuchs.com

North American Headquarters

Pepperl+Fuchs Inc.
1600 Enterprise Parkway
Twinsburg, Ohio 44087
USA
Phone: +1 330 425-3555
E-mail: sales@us.pepperl-fuchs.com

Asia Headquarters

Pepperl+Fuchs Pte. Ltd.
P+F Building
18 Ayer Rajah Crescent
Singapore 139942
Phone: +65 6779-9091
E-mail: sales@sg.pepperl-fuchs.com
<https://www.pepperl-fuchs.com>

1	History of the Manual	4
2	Introduction.....	5
2.1	Content of this Document.....	5
2.2	Target Group, Personnel	5
2.3	Symbols Used	6
3	Product Description	7
3.1	Overview.....	7
3.2	Technical Data.....	10
3.3	Dimensions and Type Labels.....	15
3.4	Scope of Delivery.....	16
3.5	Disposal	16
4	Installation.....	17
4.1	General Installation Requirements	17
4.2	Special Conditions of Use	17
4.3	Terminal Compartments.....	18
4.4	Mechanical Installation	26
5	BIOS Settings	28
6	Factory Reset	29
7	Appendix	30
7.1	System Health Monitoring	30

1 History of the Manual

The following editions of the manual have been released:

Version	Comments
09/2023	First edition
09/2024	TCU configuration Addition IGEL OS Removal of Div. 2 Marking

2 Introduction

2.1 Content of this Document

This document contains information that you need in order to use your product throughout the applicable stages of the product life cycle. These can include the following:

- Product identification
- Delivery, transport, and storage
- Mounting and installation
- Commissioning and operation
- Maintenance and repair
- Troubleshooting
- Dismounting
- Disposal

**Note**

This document does not substitute the instruction manual.

**Note**

For full information on the product, refer to the instruction manual and further documentation on the Internet at www.pepperl-fuchs.com.

**Note**

For specific device information such as the year of construction, scan the QR code on the device. As an alternative, enter the serial number in the serial number search at www.pepperl-fuchs.com.

The documentation consists of the following parts:

- Present document
- Instruction manual
- Datasheet

Additionally, the following parts may belong to the documentation, if applicable:

- EU-type examination certificate
- EU declaration of conformity
- Attestation of conformity
- Certificates
- Control drawings
- Functional safety manual
- Additional documents

2.2 Target Group, Personnel

Responsibility for planning, assembly, commissioning, operation, maintenance, and dismantling lies with the plant operator.

Only appropriately trained and qualified personnel may carry out mounting, installation, commissioning, operation, maintenance, and dismantling of the product. The personnel must have read and understood the instruction manual and the further documentation.

Prior to using the product make yourself familiar with it. Read the document carefully.

2.3 Symbols Used

This document contains symbols for the identification of warning messages and of informative messages.

Warning Messages

You will find warning messages, whenever dangers may arise from your actions. It is mandatory that you observe these warning messages for your personal safety and in order to avoid property damage.

Depending on the risk level, the warning messages are displayed in descending order as follows:



Danger!

This symbol indicates an imminent danger.

Non-observance will result in personal injury or death.



Warning!

This symbol indicates a possible fault or danger.

Non-observance may cause personal injury or serious property damage.



Caution!

This symbol indicates a possible fault.

Non-observance could interrupt the device and any connected systems and plants, or result in their complete failure.

Informative Symbols



Note

This symbol brings important information to your attention.



Action

1. This symbol indicates a paragraph with instructions. You are prompted to perform an action or a sequence of actions.

3 Product Description

3.1 Overview

Pepperl+Fuchs VisuNet Computing Units TCU1100-*/TCU1200-* and PCU1100-*/PCU1200-* are ATEX/IECEX certified devices intended for use in potentially explosive atmospheres, up to Zone 1/21 and 2/22.

Connected to Pepperl+Fuchs display units, the TCU and PCU devices serve as thin-client- or PC-based computing units. The TCU devices run VisuNet RM Shell firmware and allow users to easily connect to a host system via Ethernet. The PCU devices run a pre-installed Windows® operating system and allow users to install individual software packages such as SCADA applications to visualize and control their automation application.

Two USB Ex i interfaces support the connection of intrinsically safe accessories that match with the provided entity parameters, such as Pepperl+Fuchs' EXTA4 keyboard and mouse system. The USB Ex-e interface can be used to connect other third-party devices that comply with the installation requirements.

For extended distances, the computing units are available with an optional multi-mode fiber-optic interface.

VisuNet computing units are optimized for use with the modular Pepperl+Fuchs HMI components Display Unit (DPU1100-*/DPU1200-*) and Power Supply unit (PSU1100-*/PSU1200-*) of the VisuNet GXP product line.



Component Overview

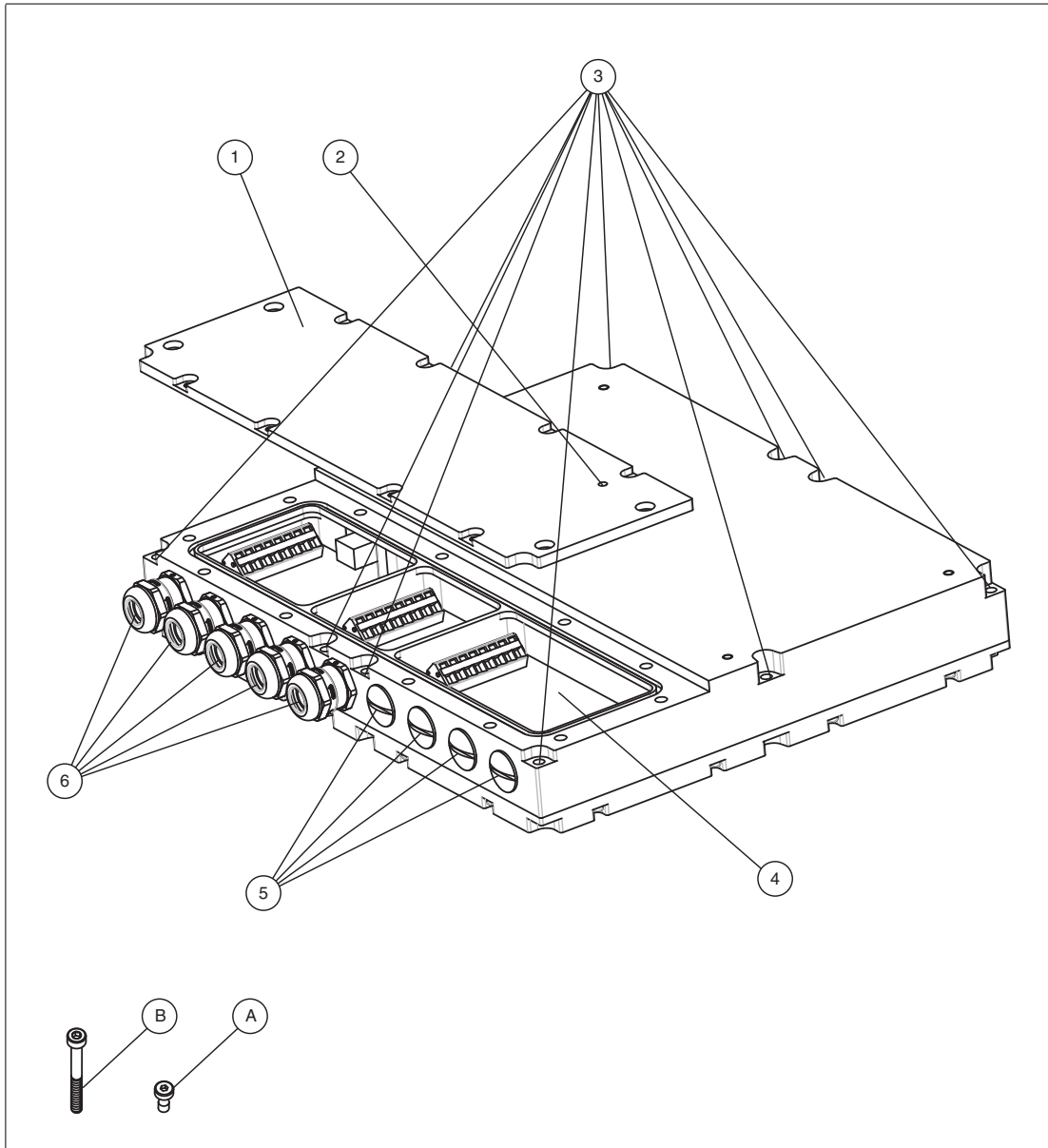

	Description	Tightening Torque
1	Terminal compartment cover	
2	Breather vent	
3	10 mounting holes	
4	Terminal compartment	
5	Optional cable glands	
6	Standard cable glands for power supply, USB Ex e, Ethernet, 2 x USB Ex i	5 Nm
A	12 x mounting screws for terminal compartment cover	1.5 Nm
B	10 x mounting screws for housing	3 Nm

2024-09



Danger!

Accumulation of condensed water within the housing can cause a short and result in an ignition.

A blocked breather vent cannot provide ventilation or drainage.

Do not block or restrict the breather vent! Do not insert any sharp objects into the breather vent!

Cable Gland Connection Layout

The cable glands have different inlays in different sizes. Therefore, it is important to use the correct installation cables with the corresponding cable gland. Do not use the cable glands for any other cable than stated below. Do not interchange the cables.

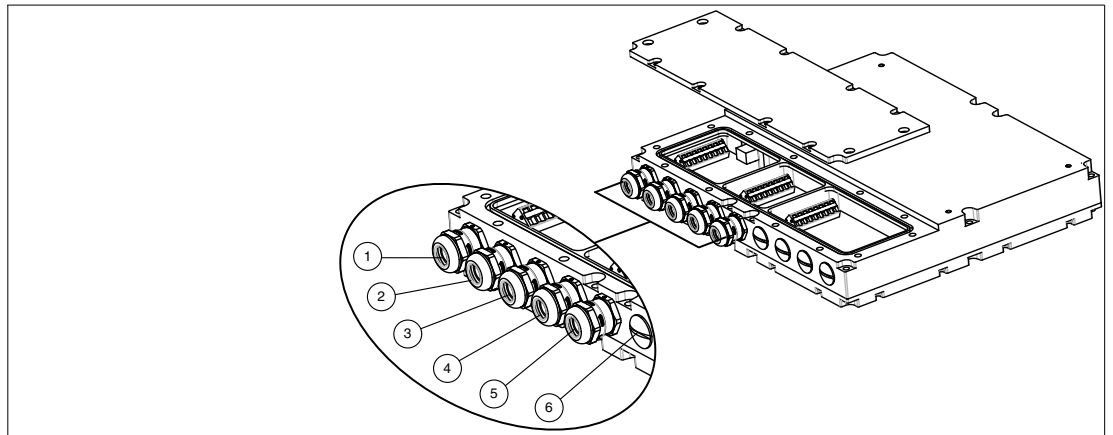

Figure 3.1 Cable gland connection layout

	Cable gland used for:	Allowed Cable Diameter	Tightening Torque
1	Power supply	6-10 mm	5 Nm
2	Ethernet	6-10 mm	
3	USB Ex e	3-7 mm	
4	USB Ex i	3-7 mm	
5	USB Ex i	3-7 mm	
6	User modules available as options, e.g., TTY Ex i, RS-232 Interface, RS-485 Interface. If option is not available, cable gland is replaced by a blind plug.	3-7 mm	

3.2 Technical Data



Note

Environmental Conditions

This equipment is designed for indoor/outdoor use at a maximum altitude of 2000 m.

PCU1100-*/PCU1200-*

Hardware

Hardware	
Processor	Intel Atom Elkhart Lake x6425RE
RAM	8 GB
Mass Storage	240 GByte industrial grade SSD Optional: 480 GByte SSD

Supply	
Input voltage	24 V DC , 2 A SELV/PELV
Power consumption	max. 48 W

Interface	
Interface type standard	Pepperl+Fuchs interface v1.0 for display units 1 x Ethernet 100/1000BASE-TX (Ex e) or 1 x fiber optic 1000BASE-SX (Multimode) or 1 x fiber optic 1000BASE-LX (Singlemode) 1 x USB 2.0 (Ex e; service port) 2 x USB 1.1 (Ex i; intended for Pepperl+Fuchs keyboard and mouse) 1 x DC or AC power in (via power supply unit)
Interface type optional	1 x barcode reader interface Pepperl+Fuchs Pscan-D/B (Ex i) "S3": 1 x barcode reader interface for wired 1- D scanners IDM-160-D*, IDM-Z1-160-D-* and base station IDMx61-B-* and IDM-Z1-x61-B-* (Ex i) "S4": 1 x barcode reader interface for wired 2- D Scanner IDM-Z1-260-D-* (Ex i) "S5": 1 x RS-232 interface with Power Supply for miscellaneous devices and peripherals (Ex i) 1 x RS-232 (Ex e) 1 x RS-485 (Ex e) 1 x Ethernet 100/1000Base-TX (Ex e) Bluetooth v4.0, communication distance up to 30 m in open terrain, transmission power +8 dBm, transmission frequency 2.402 ... 2.48 GHz

Software	
Operating System	Windows® 10 IoT Enterprise LTSC 2021 (x64)

Ambient Conditions	
Operating temperature	-20 ... 65 °C (-4 ... 149 °F)
Storage temperature	-20 ... 65 °C (-4 ... 149 °F)
Relative humidity	93% at 40°C, non-condensating, according to EN60068-2-78
Shock resistance	30 g , 11 ms all axis, IEC 60068-2-27
Vibration resistance	5 ... 100 Hz 1 G, 12 m/s ²

Mechanical specifications	
Degree of protection	IP66 (when mounted on the display unit from Pepperl+Fuchs)

Material	
Housing	Anodized aluminum
Seal	EPDM
Mass	approx. 5 kg (PCU1100-*) approx. 3 kg (PCU1200-*)
Dimensions	280 mm x 240 mm x 43 mm

TCU1100-*/TCU1200-*

Hardware	
Processor	Atom Elkhart Lake x6211E
RAM	4 GB
Mass Storage	64 GB industrial grade eMMC

Supply	
Input voltage	24 V DC \pm 10 % (SELV/PELV)
Power dissipation	14 W
Power consumption	14 W average, 30 W max.

Interface	
Interface type standard	1 x Ethernet 100/1000BASE-TX (Ex e) or 1 x fiber optic 1000BASE-SX (Multimode) or 1 x fiber optic 1000BASE-LX (Singlemode) 1 x USB 2.0 (Ex e; service port) 2 x USB 1.1 (Ex i; intended for Pepperl+Fuchs keyboard and mouse) 1 x DC or AC power in (via power supply unit)
Interface type optional	1 x barcode reader interface Pepperl+Fuchs Pscan-D/B (Ex i) "S3": 1 x barcode reader interface for wired 1-D scanners IDM-160-D*, IDM-Z1-160-D-* and base station IDMx61-B-* and IDM-Z1-x61-B-* (Ex i) "S4": 1 x barcode reader interface for wired 2-D Scanner IDM-Z1-260-D-* (Ex i) "S5": 1 x RS-232 interface with Power Supply for miscellaneous devices and peripherals (Ex i) 1 x RS-232 (Ex e) 1 x RS-485 (Ex e) 1 x Ethernet 100/1000BASE-TX (Ex e) Bluetooth v4.0, communication distance up to 30 m in open terrain, transmission power +8 dBm, transmission frequency 2.402 ... 2.48 GH



Software	
Operating System	VisuNet RM Shell 6 (based on Windows® 10 IoT Enterprise LTSC 2021 (x64)) Optional: TSJ-: IGEL OS 12 (based on Linux, pre-installed without licence) TSI-: IGEL OS 11 (based on Linux, pre-installed without licence)



Ambient Conditions	
Operating temperature	-20 ... 65 °C (-4 ... 149 °F)
Storage temperature	-20 ... 65 °C (-4 ... 149 °F)
Relative humidity	93% at 40°C, non-condensating, according to EN60068-2-78
Shock resistance	18 shocks 15 g , 11 ms all axis, IEC 60068-2-27
Vibration resistance	10 ... 150 Hz, +/- 0.075 mm , 1g, 10 cycles per axis according to EN60068-2-6

Mechanical specifications	
Degree of protection	IP66 (when mounted on the display unit from Pepperl+Fuchs)

Material	
Housing	Anodized aluminum
Mass	approx. 5 kg (TCU1100-*) approx. 4 kg (TCU1200-*)
Dimensions	280 mm x 240 mm x 43 mm

ATEX/IECEX Marking

Thin Client Unit TCU1100-J1-* PC Unit PCU1100-J1-*	
ATEX	
ATEX certificate	BVS 16 ATEX E 083 X
ATEX marking	 II 2G Ex eb q [ib] IIC T4 IP66 Gb  II 2D Ex tb [ib] IIIC T85°C IP66 Db
IECEX	
IECEX certificate	IECEX BVS 16.0060X
IECEX marking	Ex eb q [ib] IIC T4 IP66 Gb Ex tb [ib] IIIC T85°C IP66 Db

Thin Client Unit TCU1200-J2-* PC Unit PCU1200-J2-*	
ATEX	
ATEX certificate	BVS 16 ATEX E 082 X
ATEX marking	 II 3G Ex ec [ib] IIC T4 IP66 Gc  II 3D Ex tc [ib] IIIC T85°C IP66 Dc
IECEX	
IECEX certificate	IECEX BVS 16.0060X
IECEX marking	Ex ec [ib] IIC T4 IP66 Gc Ex tc [ib] IIIC T85 °C IP66 Dc

UKEx Marking

UKEx	
UKEx approval	Zone 1/21 CML 21UKEX3469X
UKEx Marking	II 2 G D Ex eb q [ib] IIC T4 Gb Ex tb [ib] IIIC T85°C Db

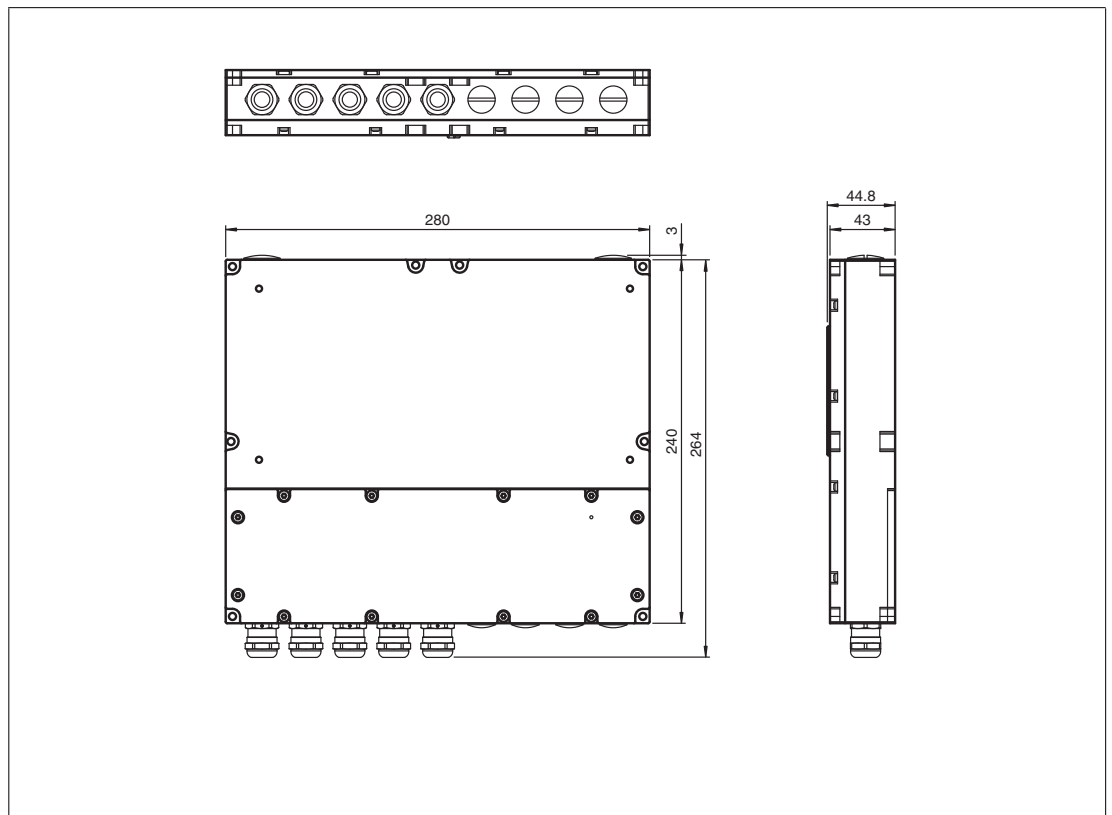

3.3 Dimensions and Type Labels

Dimensions



Labels

The following labels are present on the TCU/PCU.

<p>Warning marking "Warning – Do not open! This container has been permanently sealed and cannot be repaired." "Avertissement – Cette enveloppe est scellée en usine. Ne pas l'ouvrir!"</p>	 <p>Warning - Do not open! This container has been permanently sealed and cannot be repaired</p>
<p>Warning marking "Warning – Do not open when energized!" "Warning – Refer to instruction manual!" "Avertissement – Ne pas ouvrir sous tension!" "Avertissement – Reportez-vous au manuel d'instruction!"</p>	 <p>Warning - Do not open when energized! Warning - Refer to instruction manual!</p>

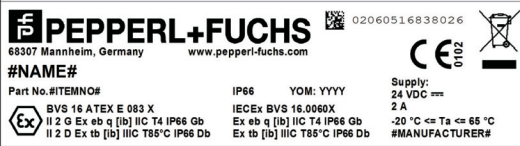
<p>Warning marking "Warning – Hot surface! Do not touch!" "Avertissement – Surface chaude! Ne pas toucher!"</p>	
<p>Type label TCU/PCU sample</p>	

3.4 Scope of Delivery

- Thin Client Unit / Personal Computer Unit
- 10 x M4 mounting screws

3.5 Disposal

Follow all local and any other requirements for disposing of electronic equipment. When disposing of any system component, mark VOID across all certification labels.

4 Installation

Watch the tutorial for the electrical installation steps on YouTube by scanning the QR code or by clicking on the following link:

English Version: https://www.youtube.com/watch?v=wBAZA-PY_OI



Figure 4.1

German Version: <https://www.youtube.com/watch?v=Gp1pUhQ32SI>

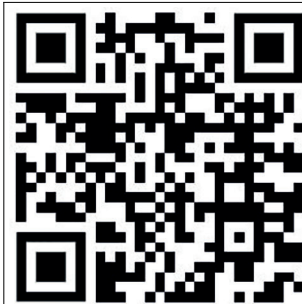

Figure 4.2

4.1 General Installation Requirements

- The equipment must be installed by competent personnel in accordance with the instructions. National laws and regulations must be observed.
- The building installation must provide a 20 A overcurrent protection.
- The installer must make a readily accessible disconnect device available.
- The safety of any system incorporating the power supply unit is the responsibility of the assembler of the system.

4.2 Special Conditions of Use

- Input power must be provided by a power supply that meets the requirements for safety extra-low protective voltage (SELV) or protective extra-low voltage (PELV).
- TCU/PCU must be mated with a suitably certified module, such as a DPU.
- Connection of TCU/PCU and display shall only be made when de-energized.

4.3 Terminal Compartments



Danger!

Danger of Explosion

Disconnecting cables too quickly may trigger an ignition, as device-internal cable capacitances need some time to discharge.

After de-energizing, wait 3 minutes before opening the compartment room or disconnecting the device from the display unit.

There are 3 terminal compartments on the back of the PCU/TCU:

- Terminal Compartment **Ex e** contains the Ex e power supply interface, an Ex e USB interface, an Ex e Ethernet interface, or an optional 1000-BASE-SX fiber optic Multimode interface or an optional 1000BASE-LX fiber optic Singlemode interface.
- Terminal Compartment **Ex i** contains a terminal block for 2 Ex i USB connectors.
- The third terminal compartment contains additional optional interfaces for user modules (TTY, Ethernet, RS-232, or RS-485, and scanner options).

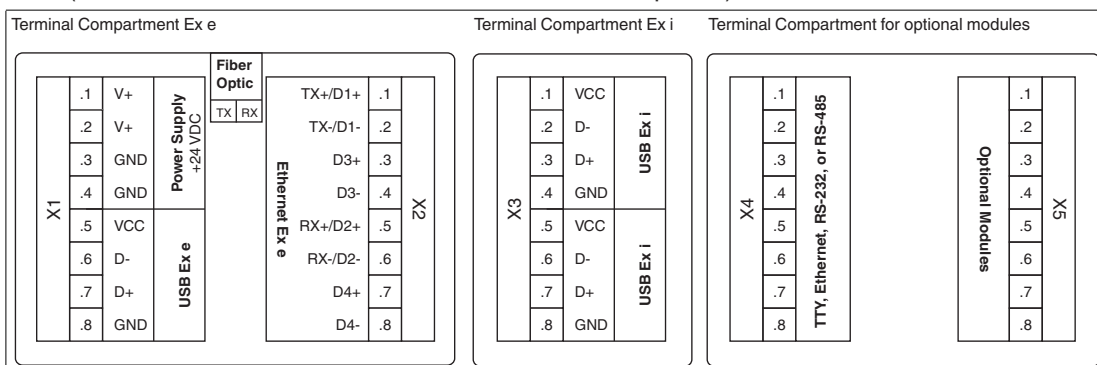

Figure 4.3 Terminal compartments

Note

For entity parameters, see the EU-Type Examination Certificate. This document is available on the TCU/PCU product pages at www.pepperl-fuchs.com.

Terminal Compartment Ex e

X1: Power Supply +24 V DC / USB Ex e

















Terminal		
X1.1	V+	Power Supply
X1.2	V+	
X1.3	GND	
X1.4	GND	
X1.5	VCC	USB Ex e
X1.6	D-	
X1.7	D+	
X1.8	GND	

The table below gives an overview of the 2 color schemes:

The Ethernet terminal assignment can be done either by EIA/TIA-568A or by EIA/TIA-568B color scheme. Choose the color scheme according to your factory standard.

We recommend using S/FTP Cat.7 Ethernet cables to achieve best signal quality and longest communication distances.

X2: Ethernet Ex e

Terminal		Ethernet Terminal Assignment acc. EIA/TIA-568B	Ethernet Terminal Assignment acc. EIA/TIA-568A
X2.1	Tx+/D1+	 white / orange line	 white / green line
X2.2	Tx-/D1-	 orange / white line OR fully orange	 green / white line OR fully green
X2.3	D3+	 blue / white line OR fully blue	 blue / white line OR fully blue
X2.4	D3-	 white / blue line	 white / blue line
X2.5	RX+/D2+	 white / green line	 white / orange line
X2.6	RX-/D2-	 green / white line OR fully green	 orange / white line OR fully orange
X2.7	D4+	 white / brown line	 white / brown line
X2.8	D4-	 brown / white line OR fully brown	 brown / white line OR fully brown

Optional Fiber-Optic Interface

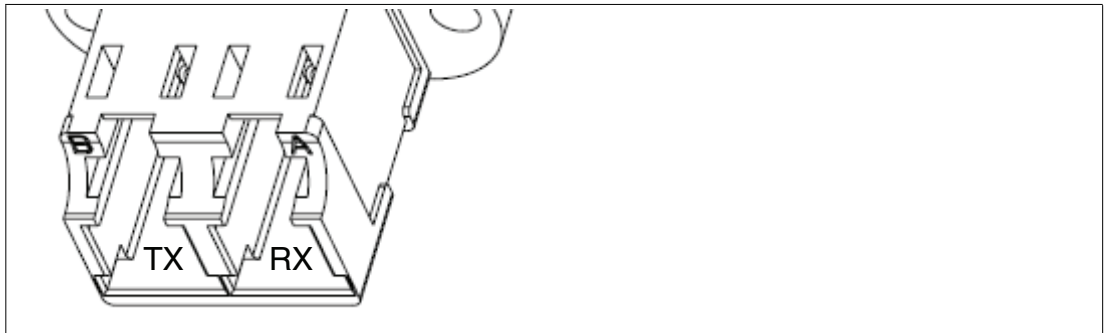

Figure 4.4 For the optional Fiber optic interface a duplex LC connection is required.



Note

When the fiber-optic interface is installed, no terminal connections are available at X2.

Multimode: Fiber Optic Specifications

Minimum cable requirement	OM2 (50/125 μm)
Data rate	1 Gb
Max. distance	550 m
Mode	Multimode
Category	1000BASE-SX
Link budget	3 dB (in addition to cabling with 550 m OM2)—if counterpart uses Horizon GXP, AFBR-5710 transceiver, 1002MC/SX media converter , or equivalent

Singlemode: Fiber Optic Specifications

Minimum cable requirement	OS2 (9/125 µm)
Data rate	1 Gb
Max. distance	10 km
Mode	Singlemode
Category	1000BASE-LX
Link lengths	1.25 GBd 0.5 m to 550 m - 50 µm MMF 0.5 m to 550 m - 62.5 µm MMF 0.5 m up to 10 km - SMF

The TX marking on the interface indicates the transmitted signal from the TCU/PCU to the connected device (switch). Connect the RX of the fiber-optic cable here.

The RX marking shows the receiving signal of the TCU/PCU from the connected device (switch). Connect the TX of the fiber-optic cable here.

Note



The fiber-optic interface of the TCU/PCU can be connected and safely operated with other devices that comply with Class 1 limits in accordance with IEC 60825-1 or that are classified as inherently safe optical radiation "op is" in accordance with IEC 60079-28.

Terminal Compartment Ex i

X3: USB for Keyboard and Mouse EXTA4 (2020 Generation) Ex i

TCU			Peripheral		
Terminal	Signal			Assignment	Color coding
	Name	Direction			
X3.1	VCC	Supply	1st USB Ex i (Keyboard)	VCC (Ui)	green
X3.2	D-	I/O		D-	gray
X3.3	D+	I/O		D+	brown
X3.4	GND	Supply		GND	yellow
X3.5	VCC	Supply	2nd USB Ex i (Mouse)	VCC (Ui)	red
X3.6	D-	I/O		D-	pink
X3.7	D+	I/O		D+	white
X3.8	GND	Supply		GND	blue

X3: USB for Keyboard and Mouse EXTA4 (2024 Generation) Ex i

	Assignment	Color coding
Keyboard and Mouse	Us	Red
	D-	White
	D+	Green
	GND	Black

Terminal Compartment for Optional Modules Ex i

X4 or X5: TTY "BR" Scanner Option for PSCAN-D/PSCAN-B Handheld Reader Ex i

TCU			Cable		
Terminal	Signal		Assignment	Color coding	Pin M12 connector
	Name	Direction			
Xx.1	Us	Supply	Us	yellow	4
Xx.2	GND	Supply	GND	brown/gray	1/5
Xx.3	-	-	-	-	-
Xx.4	TxD	O	RxD	green	3
Xx.5	-	-	-	-	-
Xx.6	RxD	I	TxD	white	2
Xx.7	-	-	-	-	-
Xx.8	-	-	-	-	-

DATL-PSCAN-D-XX00-N0 Power Cable for PSCAN-*

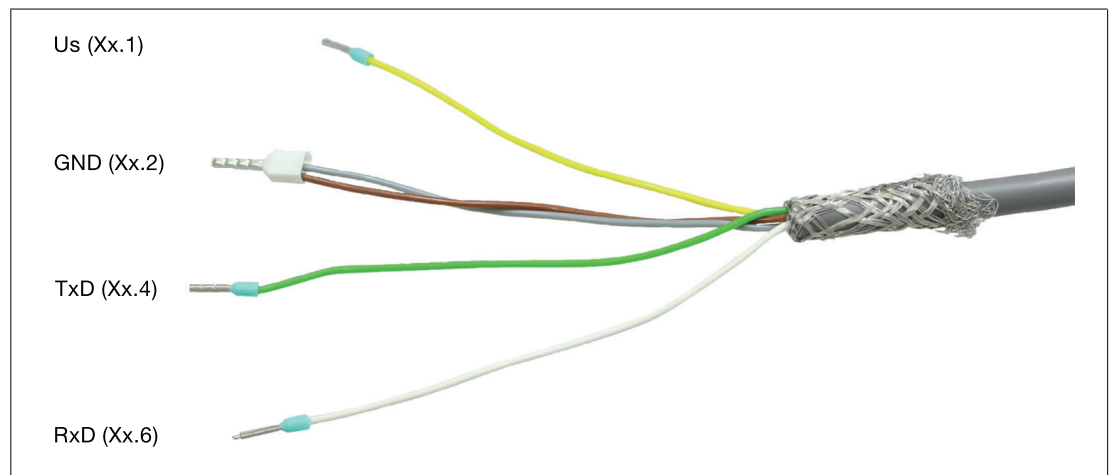

Figure 4.5

X4 or X5: "S3" Scanner Option for 1-D Handheld Barcode Reader IDM160*, IDM-Z1-160*, Base Station IDMx61-B-N0* Ex i and IDM-Z1-x61-B-N0*

TCU			Cable		
Terminal	Signal		Assignment	Color coding	Pin M12 connector
	Name	Direction			
Xx.1	Vcc	Supply	Vcc	green	1
Xx.2	GND	Supply	GND	brown	3
Xx.3	-	-	-	-	-
Xx.4	-	-	-	-	-
Xx.5	-	-	-	-	-
Xx.6	RxD	I	TxD	white	4
Xx.7	-	-	-	-	-
Xx.8	-	-	-	-	-

DATL-IDM-DB-S-XX00-N0 Connection Cable for IDM-Z1-160-D-1D-*

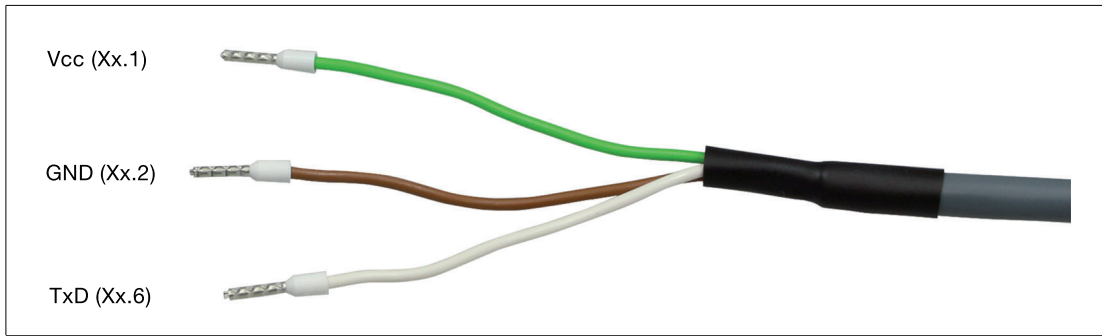

Figure 4.6

X4 or X5: "S4" Scanner Option for 2-D handheld barcode reader IDM-Z1-260-D-2D-* Ex i

Terminal Compartment Ex i					
TCU			Cable		
Terminal	Signal				
	Name	Direction	Assignment	Color coding	Pin M12 connector
Xx.1	US	Supply	Vcc	green	1
Xx.2	RxD	I	TxD	white	4
Xx.3	-	-	-	-	-
Xx.4	-	-	-	-	-
Xx.5	GND	Supply	GND	brown	3
Xx.6	-	-	-	-	-
Xx.7	-	-	-	-	-
Xx.8	-	-	-	-	-

DATL-IDM-DB-S-XX00-N0 Connection Cable for IDM-Z1-260-D-1D-*

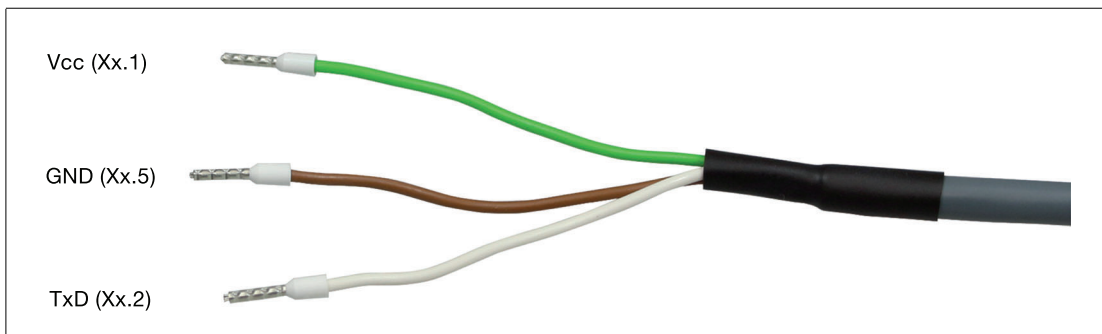

















Figure 4.7

X4 or X5: "S5" RS-232 interface Option for miscellaneous devices and peripherals Ex i

Terminal Compartment Ex i		
TCU		
Terminal	Signal	
	Name	Direction
Xx.1	US	Supply
Xx.2	RxD	I
Xx.3	TxD	O
Xx.4	-	-
Xx.5	GND	Supply
Xx.6	-	-
Xx.7	RTS	O
Xx.8	CTS	I

X4 or X5: 100/1000BASE-TX Option "ET" Ex e

Terminal		Ethernet Terminal Assignment acc. EIA/TIA-568B	Ethernet Terminal Assignment acc. EIA/TIA-568A
Xx.1	Tx+/D1+	 white / orange line	 white / green line OR fully green
Xx.2	Tx-/D1-	 orange / white line OR fully orange	 green / white line
Xx.3	D3+	 blue / white line OR fully blue	 blue / white line OR fully blue
Xx.4	D3-	 white / blue line	 white / blue line
Xx.5	RX+/D2+	 white / green line	 white / orange line
Xx.6	RX-/D2-	 green / white line OR fully green	 orange / white line OR fully orange
Xx.7	D4+	 white / brown line	 white / brown line
Xx.8	D4-	 brown / white line OR fully brown	 brown / white line OR fully brown

X4 or X5: RS-232 Option "S1" Ex e

TCU		
Terminal	Signal	
	Name	Direction
Xx.1	-	-
Xx.2	-	-
Xx.3	-	-
Xx.4	-	-
Xx.5	Rx	I
Xx.6	Tx	O
Xx.7	GND	-
Xx.8	-	-

2024-09

RS-232 Specifications

Cable	Shielded 0.75 mm ² (e.g., LiYCY 4 x 0.75)
Max. distance (acc. standard)	15 m
Max. distance (measured)	1000 m
Max. baud rate at 1000 m (depending on cable)	460.800 kBit/s
Max. baud rate (direct loopback)	1 Mbaud

X4 or X5: RS-485 Option "S2" Ex e

TCU		
Terminal	Signal	
	Name	Direction
Xx.1	120A	Termination
Xx.2	Y	O
Xx.3	120Z	Termination
Xx.4	A	I
Xx.5	B	I
Xx.6	Z	O
Xx.7	GND	-
Xx.8	HD/FD	(Control function)

RS-485 Cabling

Possible network connections include the following:

- Full duplex
- Terminated (120 Ohm) full duplex
- Half duplex
- Terminated half duplex

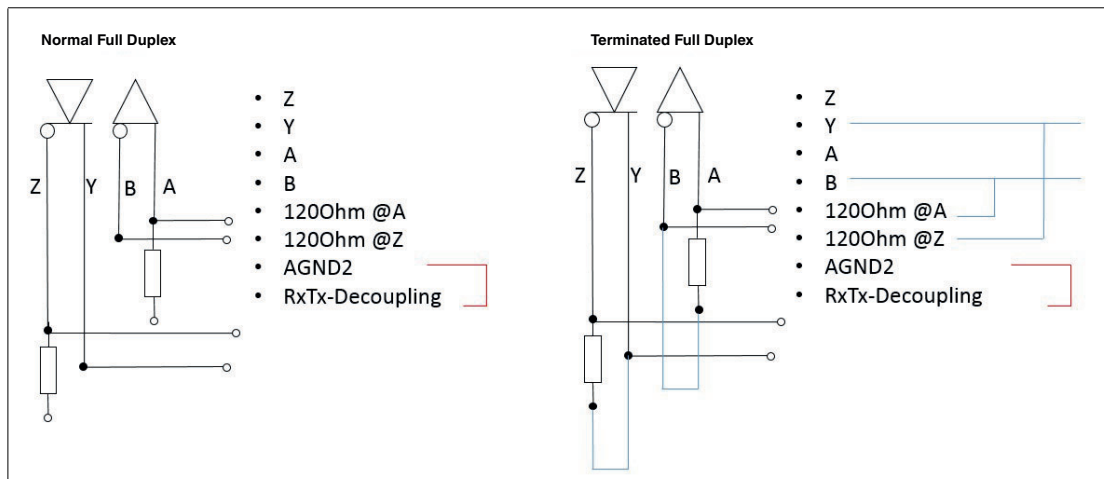

Figure 4.8 Full duplex cabling

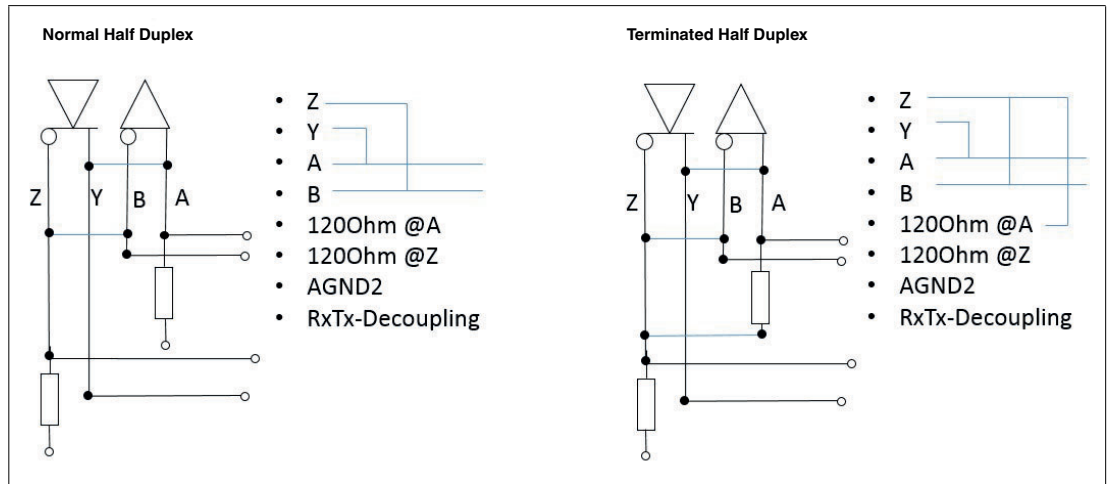

Figure 4.9 Half duplex cabling

RS-485 Specifications

Cable	Shielded 0.75 mm ² (e.g., LiYCY 4 x 0.75)
Max. distance (acc. standard)	1200 m
Max. baud rate at 10 m	1.843200 MBit/s
Max. baud rate at 1000 m (depending on cable)	460.800 kbit/s



Warning!

Danger of Explosion

Cable insulation may become damaged if cables and connection lines are not used in adequate temperature ranges. Thus, short circuits within the cable may occur which in turn may give rise to sparks and/or surface temperatures capable of triggering an ignition.

Only use cables and connection lines which are suitable to be used within a temperature rating of 80 °C if the system components are used within an ambient operating temperature of $T_a > 55\text{ °C}$.

4.4 Mechanical Installation



Danger!

Danger of Explosion

Disconnecting cables too quickly may trigger an ignition, as device-internal cable capacitances need some time to discharge.

After de-energizing, wait 3 minutes before opening the compartment room or disconnecting the device from the display unit.



Tip

Watch the tutorial for this installation step on Youtube by scanning the QR code or by clicking on the following link: <https://www.youtube.com/watch?v=xk7Kv-INdHM>

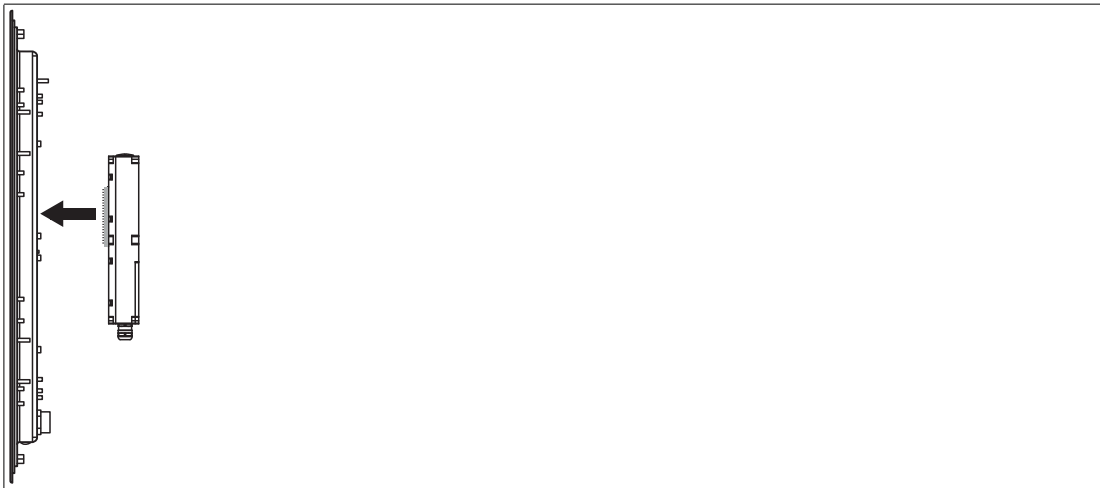

Figure 4.10



Mounting the TCU/PCU onto the Display Unit

1. Ensure the correct position of the TCU/PCU.
2. Place the TCU/PCU with the Pepperl+Fuchs connector above the Pepperl+Fuchs socket on the back of the display unit.



3. Carefully push the Pepperl+Fuchs connector into the Pepperl+Fuchs socket.

4. Use the mounting screws to fasten the PCU/TCU onto the display unit. Tighten the screws to 2 Nm.

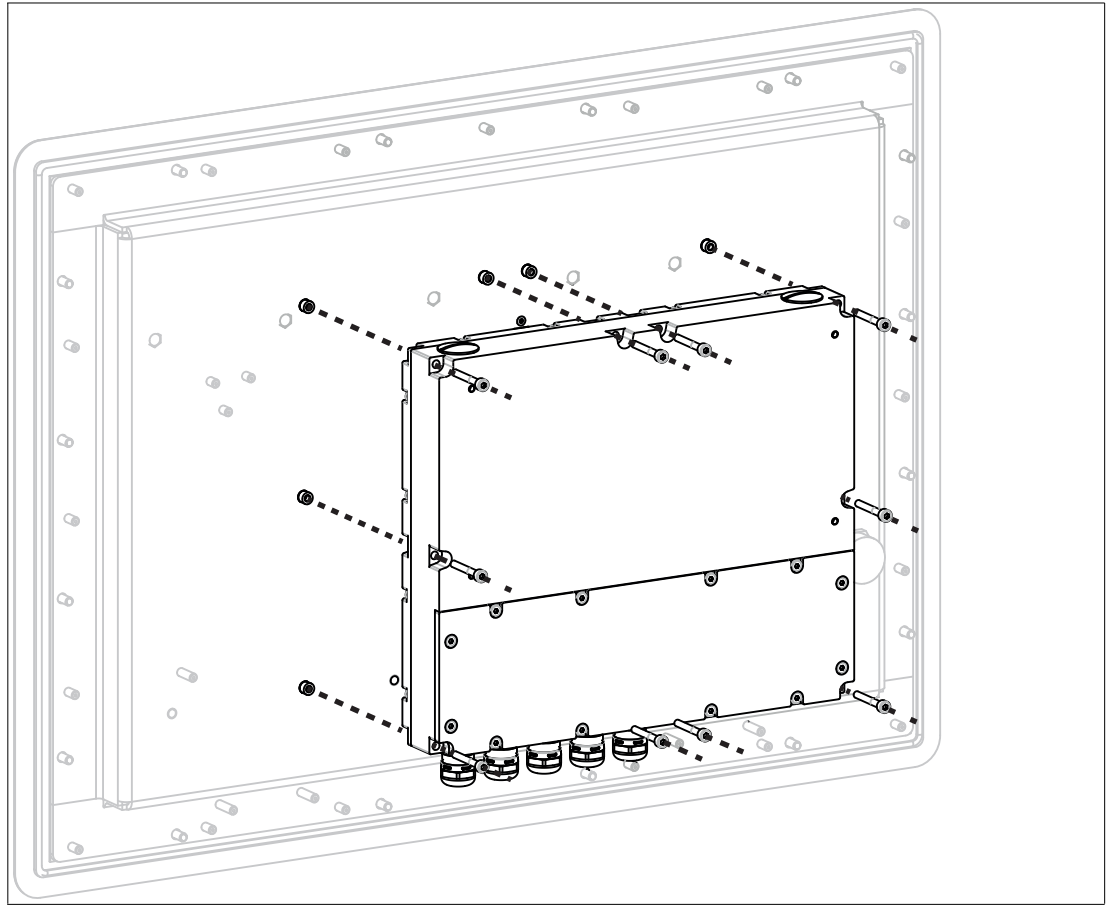

Figure 4.11 Mounting the TCU/PCU onto the display unit



Caution!

Damage to pins

Carefully align the PCU/TCU with the DPU when connecting the units. Mounting or dismantling the PCU/TCU at an angle can damage the pins.

5 BIOS Settings



Caution!

Warranty

Access to the BIOS is prohibited. Any access to the BIOS is at your own risk and is not covered by the warranty for repairs. Arbitrary changes to BIOS settings may affect device functionality. The BIOS is set according to customer requirements by default.

The default BIOS password is **pepperl**. It is recommended to change the password in order to prevent unauthorized access to the system BIOS.

The password is needed at all times to access the BIOS and/or change any BIOS settings.

The device is shipped with optimized BIOS settings and it is highly recommended not to change the BIOS settings. If they have been changed, the factory default settings can be restored following these steps:

1. Power up the system.
2. Press [DEL] key to enter the BIOS.
3. Press [F3] for default settings or [F2] for previous values.
4. Press [Enter].
5. Press [F4].
6. Press [Enter].
7. System will restart.



Note

If your device is equipped with an Intel Bay Trail Processor the default password is **hmiadmin1234**. Please refer to the type code.

6 Factory Reset

VisuNet PCUs and TCUs can be reset to their original factory configurations.

TCU

TCUs that use VisuNet RM Shell firmware can be reset via functions that are available in RM Shell. Refer to RM Shell documentation for instructions on performing a factory reset.

PCU

PCUs that use a pre-installed Windows® 10 IoT Enterprise LTSC 2021 (x64) operating system without VisuNet RM Shell can be reset using Windows® operating system functions. Refer to Microsoft® documentation for instructions on performing a factory reset.



Note

The Windows® activation key for every PCU can be found on a sticker on the device. The key is also stored as a file under C:\\$OEM\ProductKey.txt. This activation key is required when you re-install Windows® on the device.

7 Appendix

7.1 System Health Monitoring

When using the thin client unit in combination with the Pepperl+Fuchs display units DPU1100 / DPU1200-* there is a health monitoring for possible hardware errors that helps you to indicate what is wrong with the hardware components.

For the TCU there are 3 possible errors:

CPU / Display Error

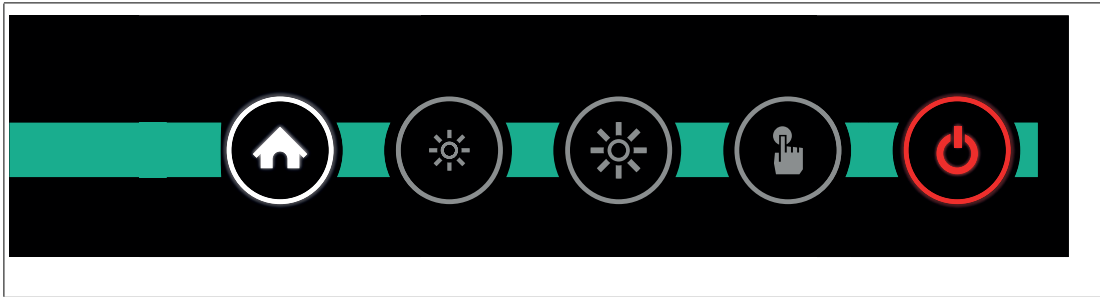

Indication	Problem	Solution
Home button solid white Power Button solid Red	CPU (Most likely Service Controller) damaged	Replace the CPU
	If backlight still turns on: Display frontkey controller damaged	Replace the display unit

Temperature Error (too Low)

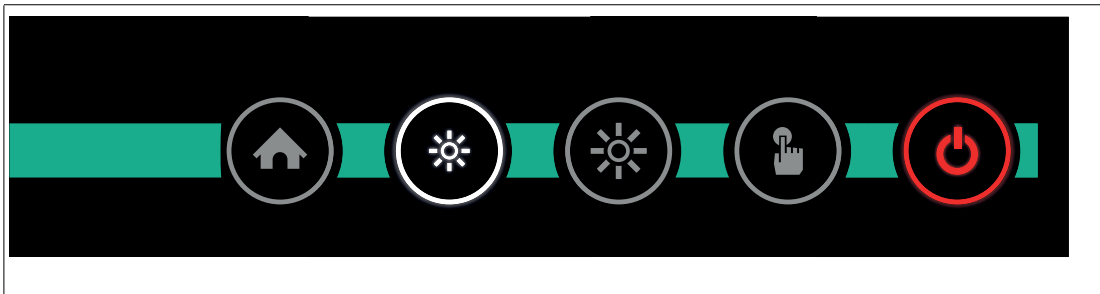

Indication	Problem	Solution
"Brightness -" button solid white Power button solid red	Temperature too low (monitored only during booting up)	Check if ambient temperature surrounding the panel is lower than the panel's allowed operating temperature.

Temperature Error (too High)

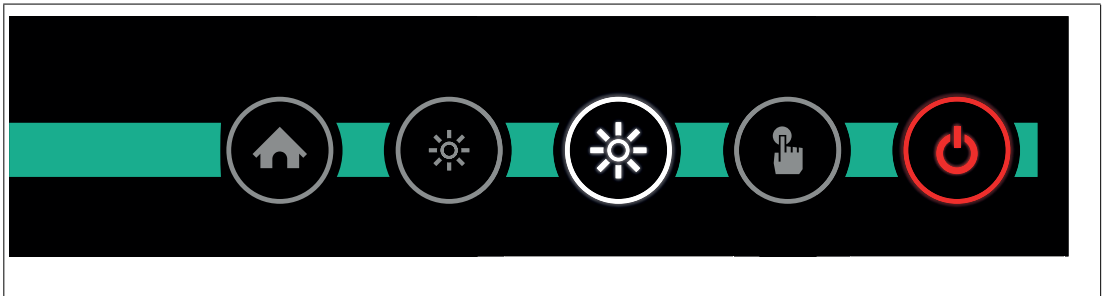

Indication	Problem	Solution
"Brightness +" button solid white Power button solid red	Temperature too high (monitored only during booting up)	Check if ambient temperature surrounding the panel exceeds the panel's allowed operating temperature.

Communication Error

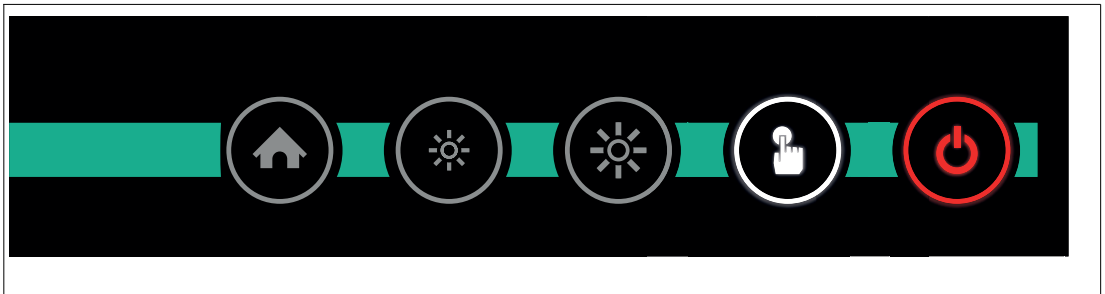

Indication	Problem	Solution
Touchscreen button solid white Power button solid red	No communication with DPU devices (e.g. storage device, temperature monitoring,...)	Replace display unit

Your automation, our passion.

Explosion Protection

- Intrinsic Safety Barriers
- Signal Conditioners
- FieldConnex® Fieldbus
- Remote I/O Systems
- Electrical Ex Equipment
- Purge and Pressurization
- Industrial HMI
- Mobile Computing and Communications
- HART Interface Solutions
- Surge Protection
- Wireless Solutions
- Level Measurement

Industrial Sensors

- Proximity Sensors
- Photoelectric Sensors
- Industrial Vision
- Ultrasonic Sensors
- Rotary Encoders
- Positioning Systems
- Inclination and Acceleration Sensors
- Fieldbus Modules
- AS-Interface
- Identification Systems
- Displays and Signal Processing
- Connectivity

Pepperl+Fuchs Quality

Download our latest policy here:

www.pepperl-fuchs.com/quality

