



# Hardware Installation and Configuration Guide



### ***Trademark Notices***

Control, DeviceMaster, and PortVision are registered trademarks of Control Corporation.

Ethernet is a registered trademark of Digital Equipment Corporation, Intel, and Xerox Corporation.

Microsoft and Windows are registered trademarks of Microsoft Corporation in the United States and/or other countries.

Modbus is a registered trademark of Schneider Electric.

PLC is a registered trademark of Allen-Bradley Company, Inc.

RedBoot is a trademark of Red Hat, Inc.

SIMATIC is a registered trademark of Siemens, AG.

Portions of SocketServer are copyrighted by GoAhead Software, Inc. Copyright © 2001. GoAhead Software, Inc. All Rights Reserved.

Other product names mentioned herein may be trademarks and/or registered trademarks of their respective owners.

Eighth Edition, October 28, 2009

Copyright © 2005 - 2009. Control Corporation.

All Rights Reserved.

Control Corporation makes no representations or warranties with regard to the contents of this document or to the suitability of the Control product for any particular purpose. Specifications subject to change without notice. Some software or features may not be available at the time of publication. Contact your reseller for current product information.

# Table of Contents

<b>Getting Started .....</b>	<b>5</b>
<b>Protocols Supported .....</b>	<b>5</b>
<b>Quick Start.....</b>	<b>5</b>
<b>Locating Software and Documentation .....</b>	<b>6</b>
<b>Hardware Installation .....</b>	<b>9</b>
<b>Installation Overview.....</b>	<b>9</b>
<b>1-Port - Enclosed Installation .....</b>	<b>10</b>
<b>1-Port - Embedded Installation.....</b>	<b>12</b>
Building the Serial Ribbon Cable.....	12
Mounting the Embedded .....	13
Attaching the Network and Serial Cables .....	14
Connecting the Power and Verifying Installation .....	14
<b>2-Port (Serial Terminal) 1E/2E Installation.....</b>	<b>16</b>
<b>2-Port (DB9) 1E/2E Installation .....</b>	<b>18</b>
<b>4-Port Installation .....</b>	<b>20</b>
<b>Adding a Unit to an Existing Installation .....</b>	<b>21</b>
<b>Replacing Hardware .....</b>	<b>21</b>
<b>Configuring the DeviceMaster UP .....</b>	<b>23</b>
<b>Installing and Upgrading PortVision Plus .....</b>	<b>23</b>
Installing PortVision Plus .....	23
Upgrading PortVision Plus.....	23
<b>Configuring the DeviceMaster UP Network Settings.....</b>	<b>24</b>
<b>Checking the Protocol Firmware Version .....</b>	<b>25</b>
<b>Uploading Protocol-Specific Firmware on the DeviceMaster UP .....</b>	<b>26</b>
<b>Connecting Serial Devices .....</b>	<b>29</b>
<b>DB9 and RJ45 Connectors .....</b>	<b>29</b>
DB9 Connectors .....	29
DB9 Null-Modem Cables (RS-232).....	30
DB9 Null-Modem Cables (RS-422).....	30
DB9 Straight-Through Cables (RS-232/485) .....	30
DB9 Loopback Plugs.....	31
RJ45 Connectors .....	31
RJ45 Null-Modem Cables (RS-232).....	31
RJ45 Null-Modem Cables (RS-422).....	32
RJ45 Straight-Through Cables (RS-232/485) .....	32
RJ45 Loopback Plugs.....	32
RJ45 RS-485 Test Cable .....	32
<b>Serial Terminals (4) - 1E .....</b>	<b>33</b>
Serial Terminal (4) Connectors .....	33
Serial Terminal (4) Null-Modem Cables (RS-232) .....	34
Serial Terminal (4) Null-Modem Cables (RS-422) .....	34
Serial Terminal (4) Straight-Through Cables (RS-232/485).....	34
1E Loopback Signals.....	35

<b>Serial Terminals (8) - 2E .....</b>	<b>36</b>
Serial Terminal (8) Connectors .....	36
Serial Terminal (8) Null-Modem Cables (RS-232) .....	37
Serial Terminal (8) Null-Modem Cables (RS-422) .....	37
Serial Terminal (8) Straight-Through Cables (RS-232/485).....	37
2E Loopback Signals.....	38
<b>Hardware Specifications.....</b>	<b>39</b>
<b>Locating DeviceMaster UP Specifications.....</b>	<b>39</b>
<b>Serial Communications.....</b>	<b>39</b>
<b>External Power Supply Specifications .....</b>	<b>40</b>
1-Port .....	40
2-Port (Serial Terminals) .....	40
2-Port (DB9) .....	40
4-Port .....	41
<b>DeviceMaster UP Product Pictures.....</b>	<b>41</b>
1-Port (DB9).....	42
1-Port Embedded.....	43
2-Port (Single Ethernet Port) with Serial Terminals.....	43
2-Port (Dual Ethernet Ports) with Serial Terminals.....	43
2-Port (Single Ethernet Port) DB9.....	44
2-Port (Dual Ethernet Ports) DB9 .....	44
4-Port (DB9).....	44
<b>Notices .....</b>	<b>45</b>
Radio Frequency Interference (RFI) (FCC 15.105) .....	45
Labeling Requirements (FCC 15.19).....	45
Modifications (FCC 15.21).....	45
Serial Cables (FCC 15.27) .....	45
Underwriters Laboratory .....	45
Important Safety Information .....	45
<b>RedBoot Procedures.....</b>	<b>47</b>
<b>Overview .....</b>	<b>47</b>
Establishing a Serial Connection .....	47
Establishing a Telnet Connection.....	48
<b>Determining the Network Settings .....</b>	<b>49</b>
<b>Configuring the Network Settings .....</b>	<b>49</b>
<b>Determining the Bootloader Version.....</b>	<b>50</b>
<b>Resetting the DeviceMaster UP .....</b>	<b>50</b>
<b>Uploading Firmware.....</b>	<b>51</b>
Serial Method.....	51
Telnet Method .....	52
<b>Configuring Passwords .....</b>	<b>54</b>
<b>Redboot Command Overview .....</b>	<b>55</b>
<b>Troubleshooting and Technical Support.....</b>	<b>57</b>
<b>Troubleshooting Checklist .....</b>	<b>57</b>
<b>General Troubleshooting.....</b>	<b>58</b>
<b>Daisy-Chaining DeviceMaster UP 2E/4-Port Units .....</b>	<b>59</b>
<b>Technical Support.....</b>	<b>60</b>
<b>Index.....</b>	<b>61</b>

# Getting Started

This guide discusses initial DeviceMaster UP installation and hardware configuration.

**Note:** *This guide does not discuss configuring the port characteristics or protocol-specific programming information. See [Locating Software and Documentation on Page 6](#) to locate the firmware and the appropriate documentation for your environment.*

## Protocols Supported

---

The DeviceMaster UP is a network attached, solid-state 1 or 4-port device server, which hosts an Industrial Ethernet engine and translates device communications to a programmable logic controller (PLC) and any serial device.

Depending on the model you purchased, the DeviceMaster UP may or may not have the protocol firmware loaded.

**Note:** *Models that have a protocol loaded on the DeviceMaster UP are identified in PortVision Plus and the DeviceMaster UP is labeled accordingly.*

When the DeviceMaster UP is loaded with the appropriate firmware for your DeviceMaster UP, it enables connectivity between any PLC and any serial device. The DeviceMaster UP supports the following protocols:

- EtherNet/IP
- Modbus/TCP
- PROFINET CbA
- PROFINET IO

## Quick Start









---











Installation and configuration follows these steps.









1. Connect the hardware (Page 9).
2. Install PortVision Plus (Page 23).
3. Configure the DeviceMaster UP network settings (Page 24).
4. If necessary, install or update the firmware on the DeviceMaster UP for your protocol (Page 26).
5. Use [Locating Software and Documentation on Page 6](#) to locate the appropriate installation document for your protocol so that you can perform the following procedures:
  - Configure port characteristics using the *Server Configuration* web page.
  - Program the PLCs.
6. Connect the serial device or devices (Page 29).

## Locating Software and Documentation

You can access the appropriate firmware assembly, PortVision Plus, and the *DeviceMaster UP* documentation from the CD shipped with the DeviceMaster UP or you can download the latest files using these internet links.

<b>PortVision Plus</b>	
<i>PortVision Plus</i> is the application that you use to configure network settings and upload the firmware for your protocol.	
<b>EtherNet/IP Firmware and Documentation</b>	
<p><b>EtherNet/IP (.msi)</b> file contains the firmware and supporting files. The firmware provides embedded configuration web pages. You may need to update the DeviceMaster UP with the latest version.</p> <p><b>Note:</b> <i>If you are currently running EtherNet/IP firmware V2.x platform, you may want refer to the EtherNet/IP User Guide for architecture information before upgrading.</i></p> <p>Depending on the model you purchased, the DeviceMaster UP may or may not have the EtherNet/IP firmware loaded.</p> <p><b>Note:</b> <i>Models that have a protocol loaded on the DeviceMaster UP are identified in PortVision Plus and the DeviceMaster UP is labeled accordingly.</i></p>	
<i>DeviceMaster UP Hardware Installation and Configuration Guide</i> (this guide) contains hardware installation, PortVision Plus installation, and firmware updating procedures.	
<i>EtherNet/IP Interface Configuration Quick Start</i> contains configuration procedures for the DeviceMaster UP embedded web pages.	
<i>EtherNet/IP User Guide</i> contains detailed protocol-specific information about the DeviceMaster UP.	
<i>DeviceMaster UP Filtering and Data Extraction Reference Guide</i> describes the data extraction and filtering processes provided by the DeviceMaster UP with EtherNet/IP.	
<i>Bootloader (.bin)</i> is the operating system that runs on the DeviceMaster UP hardware during the power on phase, which then starts the default application (either EtherNet/IP or SocketServer). The bootloader can be disabled and you can communicate to the device using Redboot.	
<i>SocketServer (.bin)</i> may be the DeviceMaster UP default application that is loaded on the unit, if the model is not loaded with EtherNet/IP firmware.	

<b>Modbus/TCP Firmware and Documentation</b>	
<p><b>Modbus/TCP (.msi)</b> contains the firmware and supporting files. The firmware provides embedded configuration web pages. You may need to update the DeviceMaster UP with the latest version.</p> <p><b>Note:</b> <i>If you are currently running Modbus/TCP firmware V2.x platform, you may want refer to the DeviceMaster UP Modbus/TCP User Guide for architecture information before upgrading.</i></p> <p>Depending on the model you purchased, the DeviceMaster UP may or may not have the Modbus/TIP firmware loaded.</p> <p><b>Note:</b> <i>Models that have a protocol loaded on the DeviceMaster UP are identified in PortVision Plus and the DeviceMaster UP is labeled accordingly.</i></p>	
<p><i>DeviceMaster UP Hardware Installation and Configuration Guide</i> (this guide) contains hardware installation, PortVision Plus installation, and firmware updating procedures.</p>	
<p><i>Modbus/TCP Interface Configuration Quick Start</i> contains an installation overview and configuration procedures for DeviceMaster UP embedded web pages.</p>	
<p><i>Modbus/TCP User Guide</i> contains detailed protocol-specific information about the DeviceMaster UP.</p>	
<p><i>DeviceMaster UP Filtering and Data Extraction Reference Guide</i> describes the data extraction and filtering processes provided by the DeviceMaster UP with Modbus/TCP 3.x firmware or higher.</p>	
<p><b>Bootloader (.bin)</b> the operating system that runs on the DeviceMaster UP hardware during the power on phase, which then starts the default application (either Modbus/TCP or SocketServer). The bootloader can be disabled and you can communicate to the device using Redboot.</p>	
<p><b>SocketServer (.bin)</b> may be the DeviceMaster UP default application that is loaded on the unit, if the model is not loaded with Modbus/TCP firmware.</p>	
<b>PROFINET CbA Firmware and Documentation</b>	
<p><b>PROFINET CbA (.msi)</b> contains the firmware and supporting files. The firmware provides embedded configuration web pages. You may need to update the DeviceMaster UP with the latest version.</p> <p>Depending on the model you purchased, the DeviceMaster UP may or may not have the PROFINET CbA firmware loaded.</p> <p><b>Note:</b> <i>Models that have a protocol loaded on the DeviceMaster UP are identified in PortVision Plus and the DeviceMaster UP is labeled accordingly.</i></p>	
<p><i>DeviceMaster UP Hardware Installation and Configuration Guide</i> (this guide) contains hardware installation, PortVision Plus installation, and firmware updating procedures.</p>	
<p><i>PROFINET CbA Quick Start</i> is an outline of the installation and configuration procedures with links to the appropriate documents.</p>	
<p><i>PROFINET CbA User Guide</i> contains protocol-specific information about configuring the DeviceMaster UP.</p>	

<b>PROFINET CbA Firmware and Documentation (Continued)</b>	
<i>Bootloader (.bin)</i> the operating system that runs on the DeviceMaster UP hardware during the power on phase, which then starts the default application (either PROFINET CbA or SocketServer). The bootloader can be disabled and you can communicate to the device using Redboot.	
<i>SocketServer (.bin)</i> may be the DeviceMaster UP default application that is loaded on the unit, if the model is not loaded with PROFINET CbA firmware.	
<b>PROFINET IO Firmware and Documentation</b>	
<p><b>PROFINET IO (.msi)</b> contains the firmware and supporting files. The firmware provides embedded configuration web pages. You may need to update the DeviceMaster UP with the latest version.</p> <p>Depending on the model you purchased, the DeviceMaster UP may or may not have the PROFINET IO firmware loaded.</p> <p><b>Note:</b> <i>Models that have a protocol loaded on the DeviceMaster UP are identified in PortVision Plus and the DeviceMaster UP is labeled accordingly.</i></p>	
<i>DeviceMaster UP Hardware Installation Guide</i> (this guide) contains hardware installation, PortVision Plus installation, and firmware updating procedures.	
<i>PROFINET IO Quick Start</i> is an outline of the installation and configuration procedures with links to the appropriate documents.	
<i>DeviceMaster UP Filtering and Data Extraction Reference Guide</i> describes the data extraction and filtering processes provided by the DeviceMaster UP with PROFINET IO.	
<i>Bootloader (.bin)</i> the operating system that runs on the DeviceMaster UP hardware during the power on phase, which then starts the default application (either PROFINET IO or SocketServer). The bootloader can be disabled and you can communicate to the device using Redboot.	
<i>SocketServer (.bin)</i> may be the DeviceMaster UP default application that is loaded on the unit, if the model is not loaded with PROFINET IO firmware.	



# Hardware Installation

## Installation Overview

---

---

The DeviceMaster UP enables communications with serial devices over an Ethernet network. The DeviceMaster UP provides for remote management, configuration, and connectivity through its 10/100BASE-T Ethernet connection.

Use the links below to locate installation procedures for the following models:

### Default Network Settings

IP address:  
192.168.250.250  
Subnet mask:  
255.255.0.0  
Gateway address:  
192.168.250.1

Ports	DeviceMaster UP	Installation Procedure
1†	DB9 serial port with a single Ethernet port	<a href="#">1-Port - Enclosed Installation on Page 10</a>
1	Embedded system	<a href="#">1-Port - Embedded Installation on Page 12</a>
2††	Screw terminal serial ports	<a href="#">2-Port (Serial Terminal) 1E/2E Installation on Page 16</a>
2‡	DB9 serial ports	<a href="#">2-Port (DB9) 1E/2E Installation on Page 18</a>
4†	DB9 serial ports with dual Ethernet†† ports	<a href="#">4-Port Installation on Page 20</a>
† The DeviceMaster UP 4 -port models also include DB9 to RJ45 adapters.		
†† One of the Ethernet ports on the DeviceMaster UP 2-port 2E and the 4-port is a built-in downstream port for daisy-chaining DeviceMaster UP systems or other network-ready devices.		

## 1-Port - Enclosed Installation

Use the following procedure to install the DeviceMaster UP 1-Port

1. Record the serial number of the DeviceMaster UP on the customer service label provided.

The serial number are located on a label on the DeviceMaster UP.

**Note:** Do not connect multiple units until you have changed the default IP address, see [Initial Configuration on Page 33](#).

2. Place the 1-Port on a stable surface and skip to [Step 3](#) or optionally mount the DeviceMaster UP using the mounting flanges or DIN rail adapters.

- a. Pick up the DeviceMaster UP so that the front of the device is facing you.
- b. Pick up a DIN rail clip. (The three tines should be on top and the M4 label should face you.)

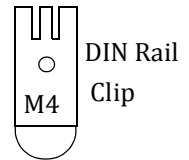

- c. Slide the DIN rail clip behind the DeviceMaster UP and line it up with one of the screw holes on the DeviceMaster UP.
- d. Insert the M4 screw into the hole and tighten with a Phillips screwdriver.

- e. Repeat [Steps b](#) through d with the second DIN rail clip. Make sure the screws on both DIN rail clips line up.

**Note:** If you need to remove the DeviceMaster UP from the DIN rail, exert pressure on the backside of the tabs at the bottom of both DIN rail clips.

- f. Attach the DeviceMaster UP to the DIN rail.

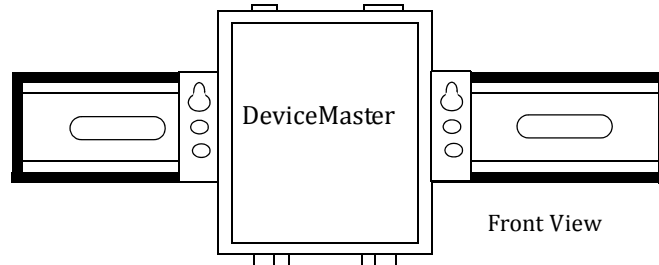
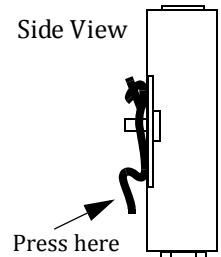

3. Connect the DeviceMaster UP port labeled **10/100 ETHERNET** to the same Ethernet network segment as the PLC using a standard network cable.

**The default serial port setting on the DeviceMaster UP is RS-232. Do not connect serial devices until you have configured the serial port settings. You must first configure the network and then upload the firmware before you can configure serial port settings.**

4. Apply power to the DeviceMaster UP using the following procedure.

**Note:** See [1-Port on Page 40](#), if you want to provide your own power supply.

**Observe proper ESD techniques when connecting and disconnecting the DeviceMaster UP.**

- Insert the earth ground wire into the earth ground screw terminal.



- Insert the DC positive wire into the positive screw terminal and the DC return wire into the return screw terminal.

If you purchased the Control power supply (separately), the wires are identified below:

- Red = 5-30VDC positive
- White = 5-30VDC return
- Black = earth ground

If you did not purchase a power supply from Control for the DeviceMaster UP, see [1-Port on Page 40](#) for power requirements.

- Use a small flat head screw to lock the wires into place.
- Verify that each wire has been tightened securely.
- Plug the screw terminal power connector into the DeviceMaster UP.

**Note:** Align the plug properly. The scalloped side of the screw terminal power connector should be aligned with the scalloped side of the power jack on the unit.

- Connect the power supply to a power source.
- Go to [Step 5](#) to verify that the DeviceMaster UP is functioning properly.

5. Verify that the **Status** LED has completed the boot cycle and network connection for the DeviceMaster UP is functioning properly using the table below.

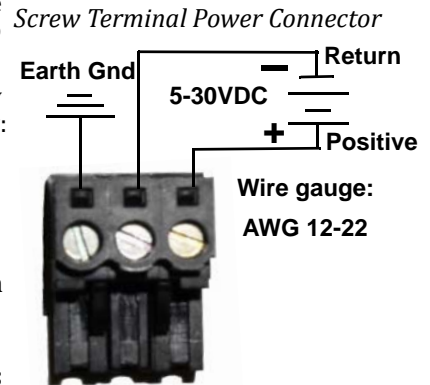

1-Port Enclosed LED Descriptions	
<b>Status</b>	The amber <b>Status</b> LED on the device is lit, indicating you have power and it has completed the boot cycle. <b>Note:</b> The <b>Status</b> LED flashes while booting and it takes approximately 15 seconds for the Bootloader to complete the cycle. When the Bootloader completes the cycle, the LED has a solid, steady light that blinks approximately every 10 seconds.
<b>Link/Act</b>	If the red <b>Link/Act</b> LED is lit, it indicates a working Ethernet connection.
<b>Duplex</b>	If the red <b>Duplex</b> LED is lit, it indicates full-duplex activity.
<b>100</b>	If the red <b>100</b> LED is lit, it indicates a working 100 MB Ethernet connection (100 MB network, only). If the LED is not lit, it indicates a 10 MB Ethernet connection.
<b>Note:</b> For additional LED information, go to the <b>Status</b> LED table on Page 57.	

6. Go to [Configuring the DeviceMaster UP on Page 23](#) to install PortVision, configure the network settings, and if necessary, upload the appropriate protocol firmware on the DeviceMaster UP.

## 1-Port - Embedded Installation

Installing the DeviceMaster UP 1-Port Embedded system follows these basic steps:

- Building the serial ribbon cable (below).
- [Mounting the Embedded on Page 13](#) and installing light pipes.
- [Attaching the Network and Serial Cables on Page 14.](#)
- [Connecting the Power and Verifying Installation on Page 14.](#)



**Caution**

**Observe proper ESD techniques when handling the DeviceMaster UP.**

### Building the Serial Ribbon Cable

Use the following information to build a DB9 serial ribbon cable to connect to the DeviceMaster UP 1-Port Embedded IDC10 connector (**J3**).

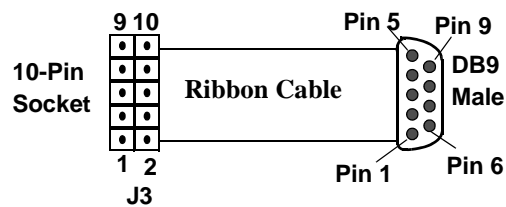

J3 Header	RS-232	RS-422	RS-485
1	CD	Not used	Not used
2	DSR	Not used	Not used
3	RxD	RxD-	Not used
4	RTS	TxD+	TRX+
5	TxD	TxD-	TRX-
6	CTS	RxD+	Not used
7	DTR	Not used	Not used
8	RI	Not used	Not used
9	GND	Not used	Not used
10	Not connected		

## Mounting the Embedded



Caution

Use the following procedure to mount the DeviceMaster UP 1-Port Embedded with the 5-30VDC power supply.

### Observe proper ESD techniques when handling the DeviceMaster UP.

- Carefully remove the DeviceMaster UP from the anti-static bag, following standard electrostatic device handling procedures.
- Mount the DeviceMaster UP for your environment using 1/4" stand-offs to separate the DeviceMaster UP from the base.

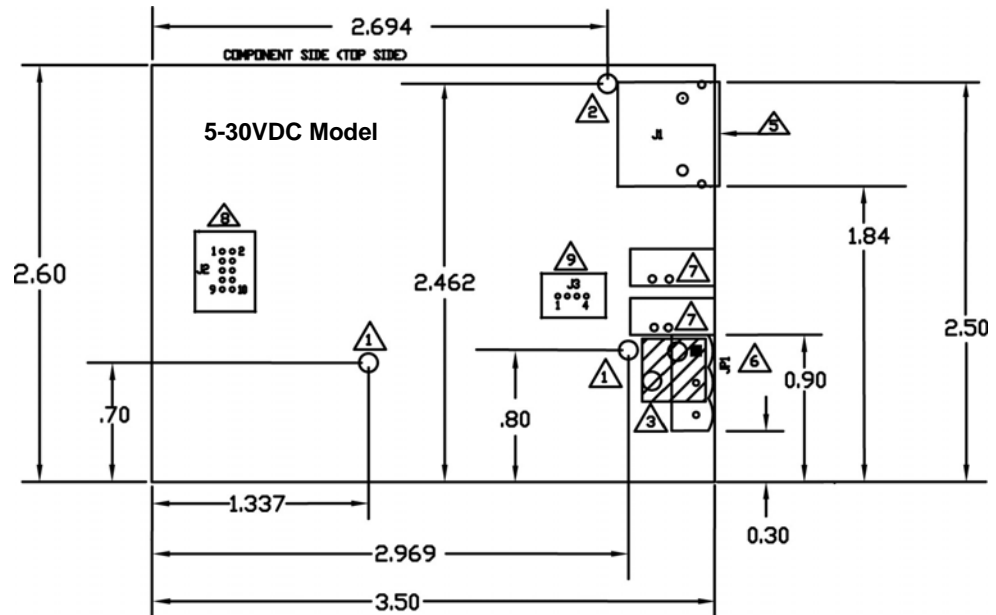

- Non-plated/non-grounded mounting holes 0.116" diameter (+/-0.003").
- Plated/chassis grounded mounting hole 0.116" diameter (+/-0.003").
- WARNING: Holes in hatched area are not mounting holes.
- Maximum component height above board is 0.55".
- Ethernet connection J2: J2 overhangs board edge by 0.14" and the height is 0.55".
- Power connector; the mating connector is Weidmuller P/N: 152651.
- LED light pipe mounting holes. The LED light pipes are not provided.
- Serial port connector J3: 0.1" pin spacing, 0.025" square pin diameter, and 0.230" pin height.
- Debug port connector J4: 0.1" pin spacing, 0.025" square pin diameter, and 0.230" pin height.



Caution

- Use one of the following methods to ground the DeviceMaster UP.
  - Through the **power supply** by connecting the ground wire on the power cable using plastic or metal stand-offs.
  - Through the **chassis**, using metal stand-offs. If plastic stand-offs are used to mount the board, then you must ground the DeviceMaster UP using the power cable.

**Note:** The maximum diameter of the metal stand-offs should be 0.175" with a 4-40 machine screw. Metal stand-offs are not provided with the DeviceMaster UP.

- Optionally, attach the light pipes. The following light pipes have been tested and found to function; Bivar, Inc. (P/N:LP-230) and Ledtronics, Inc. (P/N:LTP003-0CW-001).

After mounting the DeviceMaster UP, you are ready to connect the cables.

**Attaching the Network and Serial Cables**

Use the following procedure to attach the serial ribbon and Ethernet cables. For a larger illustration of the system, see [1-Port Embedded on Page 43](#).

1. Attach the ribbon cable built in [Building the Serial Ribbon Cable on Page 12](#) to the header labeled **J3**.

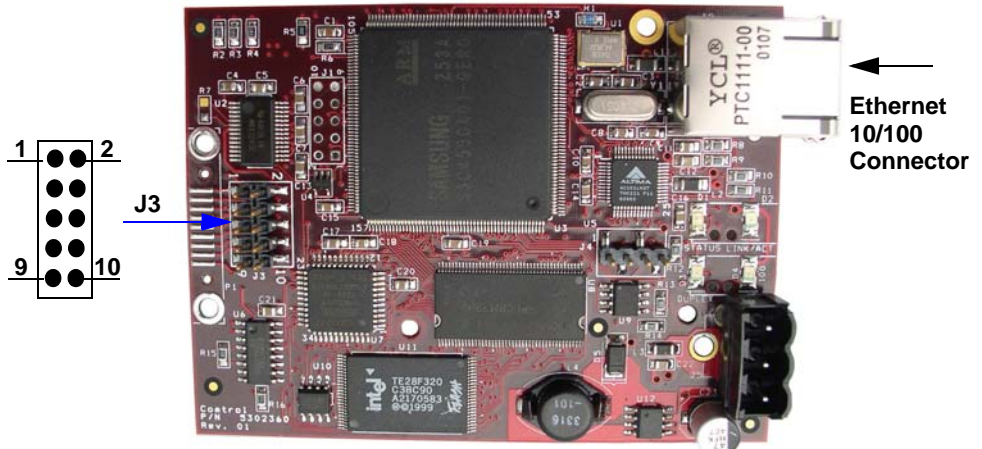

2. Connect a standard Ethernet cable from the RJ45 port on the DeviceMaster UP to your Ethernet hub.

**The default serial port setting on the DeviceMaster UP is RS-232. Do not connect the serial device until you have configured the serial port settings. You must configure network settings and upload firmware before configuring the serial port settings.**



Use the next subsection to wire the power terminal connector and verify the hardware installation.

**Connecting the Power and Verifying Installation**

Use the following procedure to wire the power terminal connector and connect the DeviceMaster UP to a power source.

**Observe proper ESD techniques when connecting and disconnecting the DeviceMaster UP.**



1. Insert the earth ground wire into the earth ground screw terminal.
2. Insert the DC positive wire into the positive screw terminal and the DC return wire into the return screw terminal.

If you purchased the Control power supply (separately), the wires are identified below:

- Red = 5-30VDC positive
- White = 5-30VDC return
- Black = earth ground

If you did not purchase a power supply from Control for the DeviceMaster UP, see [1-Port on Page 40](#) for power requirements.

3. Use a small flat head screw to lock the wires into place.
4. Verify that each wire has been tightened securely.
5. Plug the screw terminal power connector into the DeviceMaster UP.
6. Connect the power supply to a power source.

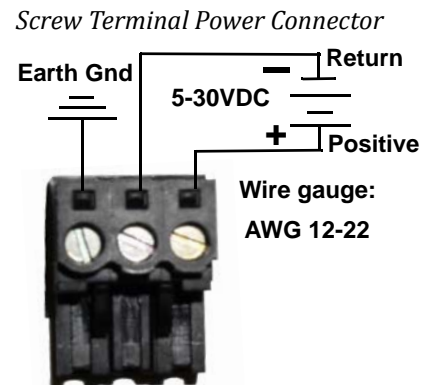

7. Plug the screw terminal power connector into **JP1** on the DeviceMaster UP by aligning the scalloped sides.

**Note:** Align the plug properly. The scalloped side of the screw terminal power connector should be aligned with the scalloped side of the power jack on the unit.

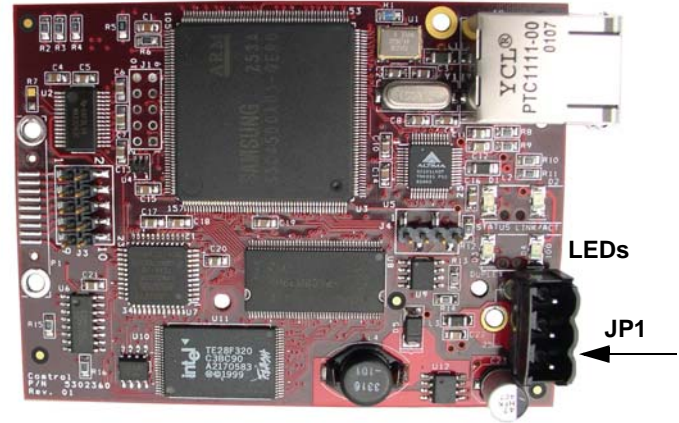

8. Apply power to the DeviceMaster UP.
9. Verify the **Status** LED has completed the boot cycle and network connection for the DeviceMaster UP is functioning properly using the table below.

The LEDs are located between the RJ45 connector and the power terminal block.

<b>1-Port Embedded LED Descriptions</b>	
<b>Status</b>	<p>When lit, the amber <b>Status</b> LED (<b>D1</b>) on the DeviceMaster UP indicates the devices is fully powered and has completed the boot cycle.</p> <p><b>Note:</b> The <b>Status</b> LED flashes for approximately 15 seconds while booting. When the Bootloader completes the cycle, the LED has a solid, steady light that blinks approximately every 10 seconds.</p>
<b>Link/Act</b>	<p>When lit, the red <b>Link/Act</b> LED (<b>D2</b>) indicates a working Ethernet connection.</p>
<b>Duplex</b>	<p>When lit, the red <b>Duplex</b> (<b>D3</b>) LED indicates full-duplex activity.</p>
<b>100</b>	<p>When lit, the red <b>100</b> (<b>D4</b>) LED indicates a working 100 MB Ethernet connection (100 MB network, only). If the LED is not lit, it indicates a 10 MB Ethernet connection.</p>
<p><b>Note:</b> For additional LED information, go to the <b>Status</b> LED table on Page 57.</p>	

10. Go to [Configuring the DeviceMaster UP on Page 23](#) to install PortVision Plus, configure the network settings, and if necessary, upload the appropriate protocol firmware on the DeviceMaster UP.

## 2-Port (Serial Terminal) 1E/2E Installation

Use the following procedure to install DeviceMaster UP 2-port models with serial terminal connectors. See [2-Port \(DB9\) 1E/2E Installation on Page 18](#) if the DeviceMaster UP has DB9 serial connectors.

- Record the serial number of the DeviceMaster UP unit on the customer service label provided.

The serial numbers are located on a label on the DeviceMaster UP.

- Attach the DeviceMaster UP 2-Port to the DIN rail adapter.
- Connect the power supply and apply power to the DeviceMaster UP using the power supply specifications on the product label and the following information.

**Observe proper ESD techniques when connecting and disconnecting the DeviceMaster UP.**



- Insert the earth ground wire into the chassis ground screw terminal. The chassis ground connection is made only if the DIN rail is NOT connected to signal ground.
- Insert the DC positive wire into the + screw terminal and the DC return wire into the - screw terminal.

If you purchased the Control power supply (separately), the wires are identified below:

- Red = 5-30VDC positive
- White = 5-30VDC return
- Black = chassis ground

If you did not purchase a power supply from Control for the DeviceMaster UP, see [2-Port \(Serial Terminals\) on Page 40](#) for power requirements.

- Use a small flat head screw driver to lock the wires into place.
- Verify that each wire has been tightened securely.
- Connect the power supply to a power source.

**Note:** Do not connect multiple units until you have changed the default IP address, see [Initial Configuration on Page 33](#).

- Use the appropriate method for network attachment of your DeviceMaster UP 2-port:  
 DeviceMaster UP **1E**: Connect the **10/100 port** to the same Ethernet network segment as the host PC using a standard network cable.

DeviceMaster UP **2E**: Connect the DeviceMaster UP 2E using one of these methods:

- Ethernet hub, switch (10/100Base-T), Server NIC (10/100Base-T)**: Connect a **10/100 port** to the same Ethernet network segment as the host PC using a standard Ethernet cable.
- Daisy-chaining DeviceMaster UP units**: Connect the port labeled **E1** (or **E2**) on the first DeviceMaster UP to the port labeled **E1** (or **E2**) on the second DeviceMaster UP or other device using a standard Ethernet cable.

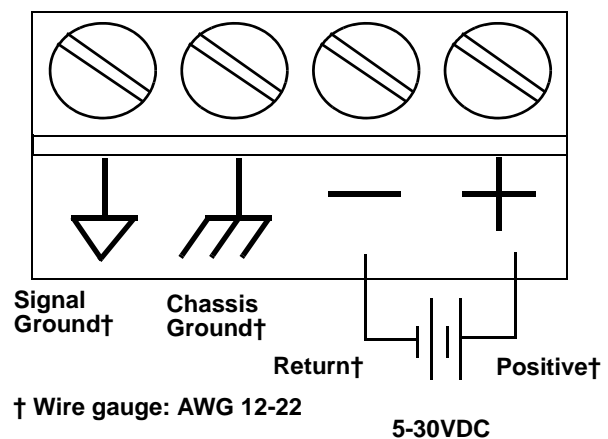

**† Wire gauge: AWG 12-22**  
**5-30VDC**  
**Signal Ground is used to connect RS-232 devices later in the installation.**





**Do not connect RS-422/485 devices until the appropriate port interface type has been configured. The default port setting is RS-232.**

5. Verify that the **Status** LED has completed the boot cycle and network connection for the DeviceMaster UP is functioning properly using the following table.

<b>2-Port Serial Terminal LED Descriptions</b>	
<b>STATUS</b>	The <b>STATUS</b> LED on the device is lit, indicating you have power and it has completed the boot cycle. <i>Note: The STATUS LED flashes while booting and it takes approximately 15 seconds for the Bootloader to complete the cycle. When the Bootloader completes the cycle, the LED has a solid, steady light that blinks approximately every 10 seconds.</i>
<b>LINK</b>	If the <b>LINK</b> (green) LED is lit, it indicates a working Ethernet connection.
<b>ACT</b>	If the <b>ACT</b> (yellow) LED flashes, it indicates network activity.
<i>Note: For additional LED information, go to the STATUS LED table on Page 57.</i>	

6. Go to [Configuring the DeviceMaster UP on Page 23](#) for default network settings and how to configure the DeviceMaster UP for use.

## 2-Port (DB9) 1E/2E Installation

Use the following procedure to install DeviceMaster UP 2-port models with DB9 connectors.

1. Record the serial number of the DeviceMaster UP unit on the customer service label provided.

The serial number are located on a label on the DeviceMaster UP.

2. Attach the DeviceMaster UP 2-Port to the DIN rail adapter.
3. Connect the power supply and apply power to the DeviceMaster UP using the power supply specifications on the product label and the following information.



**Caution**

**Observe proper ESD techniques when connecting and disconnecting the DeviceMaster UP.**

- a. Insert the earth ground wire into the chassis ground screw terminal.

**Note:** The chassis ground connection is made only if the DIN rail is NOT connected to earth ground.

- b. Insert the DC positive wire into one of the + screw terminals and the DC return wire into the - screw terminal.

A second redundant power supply can be connected to the unit by inserting the DC positive wire into the other + screw terminal and the DC return wire into the - screw terminal.

The DeviceMaster UP will continue to operate if one of the two connected power supplies should fail.

If you purchased the Control power supply (separately), the wires are identified below:

- Red = 6-30VDC positive
- White = 6-30VDC return
- Black = chassis ground

If you did not purchase a power supply from Control for the DeviceMaster UP, see [2-Port \(DB9\) on Page 40](#) for power requirements.

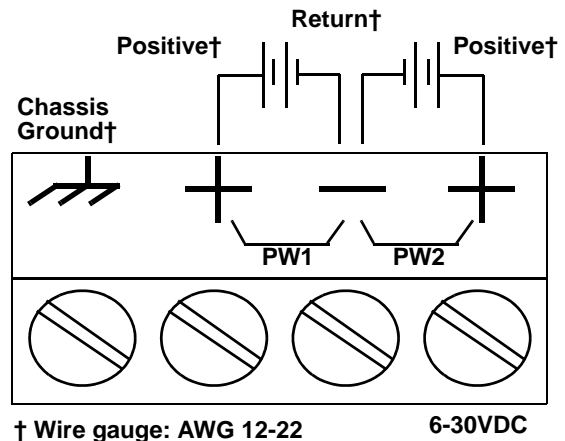

- c. Use a small flat head screw driver to lock the wires into place.
- d. Verify that each wire has been tightened securely.
- e. Connect the power supply to a power source.

**Note:** Do not connect multiple units until you have changed the default IP address, see [Initial Configuration on Page 33](#).

4. Use the appropriate method for network attachment of your DeviceMaster UP 2-port:
- DeviceMaster UP 1E:** Connect the **10/100 port** to the same Ethernet network segment as the host PC using a standard network cable.

**DeviceMaster UP 2E:** Connect the DeviceMaster UP 2E using one of these methods:

- **Ethernet hub, switch (10/100Base-T), Server NIC (10/100Base-T):** Connect a **10/100** port to the same Ethernet network segment as the host PC using a standard Ethernet cable.
- **Daisy-chaining DeviceMaster UP units:** Connect the port labeled **E1** (or **E2**) on the first DeviceMaster UP to the port labeled **E1** (or **E2**) on the second DeviceMaster UP or other device using a standard Ethernet cable.

**Do not connect RS-422/485 devices until the appropriate port interface type has been configured. The default port setting is RS-232.**



**Caution**

5. Verify that the **Status** LED has completed the boot cycle and network connection for the DeviceMaster UP is functioning properly using the following table.

2-Port DB9 LED Descriptions	
<b>STATUS</b>	The <b>STATUS</b> LED on the device is lit, indicating you have power and it has completed the boot cycle. <i>Note: The STATUS LED flashes while booting and it takes approximately 15 seconds for the Bootloader to complete the cycle. When the Bootloader completes the cycle, the LED has a solid, steady light that blinks approximately every 10 seconds.</i>
<b>LINK</b>	If the <b>LINK</b> (green) LED is lit, it indicates a working Ethernet connection.
<b>ACT</b>	If the <b>ACT</b> (yellow) LED flashes, it indicates network activity.
<b>Note:</b> For additional LED information, go to the <b>Status LED</b> table on Page 57.	

6. Go to [Configuring the DeviceMaster UP on Page 23](#) for default network settings and how to configure the DeviceMaster UP for use.

## 4-Port Installation

Use the following procedure to install the DeviceMaster UP 4-port

1. Record the serial number of the DeviceMaster UP unit on the customer service label provided.

The serial number are located on a label on the DeviceMaster UP.

**Note:** Do not connect multiple units until you have changed the default IP address, see [Initial Configuration on Page 33](#).

2. Optionally, attach the mounting brackets using the screws provided in the kit (6-32 1/4" flathead machine) or place the DeviceMaster UP on a stable surface.



[Larger Picture, Page 44](#)



Caution

**Failure to use the correct screws can damage the PCB and void the warranty. Do NOT use screws that exceed the length of the screws provided with the mounting bracket kit.**

**Note:** If you ordered the DeviceMaster Rackmount Shelf Kit accessory, use the document that accompanied that kit or [download the document](#) to mount the DeviceMaster UP on the shelf.

3. Connect the DeviceMaster UP to the same Ethernet network segment as the PLC using one of the following methods:

- **Ethernet hub or switch (10/100Base-T):** Connect to the port labeled **UP** on the DeviceMaster UP using a standard Ethernet cable.
- **Server NIC (10/100Base-T):** Connect to the port labeled **DOWN** on the DeviceMaster UP using a standard Ethernet cable.
- **Daisy-chaining DeviceMaster UP units:** Connect the port labeled **DOWN** on the first DeviceMaster UP to the port labeled **UP** on the second DeviceMaster UP or other device using a standard Ethernet cable. Refer to [Daisy-Chaining DeviceMaster UP 2E/4-Port Units on Page 59](#) for more detailed information.

**Note:** Do not connect multiple units until you have changed the default IP address, see [Configuring the DeviceMaster UP on Page 23](#).

**The default serial port setting for the DeviceMaster UP is RS-232. Do not connect any serial devices until you have configured the serial port settings. You must first configure the network settings and upload the firmware on the DeviceMaster UP before configuring the serial port settings.**



Caution

4. Apply power to the DeviceMaster UP by connecting the AC power adapter to the DeviceMaster UP, the appropriate power cord for your location to the power adapter, and plugging the power cord into a power source. If you want to provide your own power supply, see [4-Port on Page 41](#).
5. Verify that the **PWR** LED has completed the boot cycle and network connection for the DeviceMaster UP is functioning properly using the table below.

4-Port LED Descriptions	
<b>PWR</b>	<p>LED on the front panel of the DeviceMaster UP is lit, indicating you have power and it has completed the boot cycle.</p> <p><b>Note:</b> The <b>PWR</b> LED flashes while booting and it takes approximately 15 seconds for the Bootloader to complete the cycle. When the Bootloader completes the cycle, the LED has a solid, steady light that blinks approximately every 10 seconds.</p>

4-Port LED Descriptions		
<b>LNK ACT</b>	The red <b>LNK ACT</b> LED is lit, indicating that you have a working Ethernet connection.	
<b>COL</b>	If the red <b>COL LED</b> is lit, there is a network collision.	
<b>100</b>	If the red <b>100 LED</b> is lit, it indicates a working 100 MB Ethernet connection (100 MB network, only). If the LED is not lit, it indicates a 10 MB Ethernet connection.	
<b>Note:</b> For additional LED information, go to the <b>PWR LED</b> table on Page 57.		

- Go to [Configuring the DeviceMaster UP on Page 23](#) to install PortVision, configure the network settings, and if necessary, upload the appropriate protocol firmware on the DeviceMaster UP.

## Adding a Unit to an Existing Installation

Use this procedure to add another DeviceMaster UP to an existing configuration.

- Install the DeviceMaster UP to an Ethernet hub or server NIC using the appropriate subsection found in [Installation Overview on Page 9](#).
 

**Note:** Technical support recommends installing one unit at a time and testing that unit when installing multiple units. In the event troubleshooting must be done, a single unit is much easier to resolve than several at once.
- Power-up the new DeviceMaster UP and verify that the **PWR** or **Status LED** lights.
- Program an IP address into the new DeviceMaster UP using PortVision Plus.
- If necessary, upload the latest protocol firmware.
- Configure serial ports to support the serial devices or upload configuration files from PortVision Plus.
- Connect the serial devices.

## Replacing Hardware

Use this procedure to replace hardware.

- Configure the IP address in the new DeviceMaster UP.
- Remove the old unit and attach a new or spare DeviceMaster UP.
- Connect the new DeviceMaster UP to the network hub or server NIC.
- Apply power to the new DeviceMaster UP and verify that it passes the power on self-test.
- Program the IP address of the new DeviceMaster UP.
- If necessary, upload the latest protocol firmware.
- Configure any ports as necessary to match the previous unit or upload configuration files from PortVision Plus.
- Transfer *all* cabling from the old DeviceMaster UP to the new DeviceMaster UP.
- It is not necessary* to shut down and restart the host PC.



# Configuring the DeviceMaster UP

The DeviceMaster UP platform includes PortVision Plus, which is the management application that you use to:

- Configure the DeviceMaster UP network settings
- If necessary, upload protocol-specific firmware for your environment
- Access the protocol-specific *Server Configuration* page for serial port configuration

You can use PortVision Plus to monitor and manage devices from a centrally-located personal computer. PortVision Plus detects and graphically displays, in detail, every DeviceMaster UP server on the network. Network administrators can see the real-time operating conditions for each device server at a glance.

**Note:** If PortVision Plus is already installed, go directly to [Configuring the DeviceMaster UP Network Settings on Page 24](#) to change the IP address on the DeviceMaster UP.

---

## Installing and Upgrading PortVision Plus

---

PortVision Plus requires a host system running Windows 2000, Windows XP, Windows Server 2003, or Windows Vista.

Before installing PortVision Plus, consider the following:

- Use PortVision Plus to upload firmware and apply changes to a DeviceMaster UP that is on the same local network segment as the system on which PortVision Plus is installed. You cannot apply changes through PortVision Plus to a DeviceMaster UP that is not on the same local network segment
- Use PortVision Plus to monitor any DeviceMaster UP on the network. The DeviceMaster UP does not have to be on the same local network segment as PortVision Plus for monitoring purposes.

You can install or upgrade PortVision Plus from the *Software and Documentation* CD that came with your DeviceMaster UP or download the latest version.

- Install from the CD using the menu system or by executing the **.msi** file in the / **Dev\_Mstr/PortVision\_UP** directory.
- Download the latest from <http://support.comtrol.com/download.asp?partnumber=1800294>.

**Note:** See the PortVision Plus help system for information.

### Installing PortVision Plus

Use the following procedure to install PortVision Plus.

1. Execute the **pvplus\_version.msi** file.
2. Follow the *Installation Wizard* and optionally click **Launch PortVision Plus** at the last screen.

### Upgrading PortVision Plus

Use the following procedure to upgrade PortVision Plus.

1. Execute the **pvplus\_version.msi** file.
2. Click **Next** at the first screen.
3. Click **Modify** and follow the installation wizard.

## Configuring the DeviceMaster UP Network Settings

### Default Network Settings

IP address:  
192.168.250.250

Subnet mask:  
255.255.0.0

Gateway address:  
192.168.250.1

Use the following procedure to change the DeviceMaster UP network settings.

**Note:** The DeviceMaster UP must be connected to the same local network segment as the computer on which PortVision Plus is installed during initial configuration.

1. If you have not done so, install PortVision Plus (see [Installing and Upgrading PortVision Plus on Page 23](#)).
2. If necessary, start PortVision Plus by double-clicking the PortVision Plus icon or click **Start > Programs > Control > PortVision Plus**.
3. If this is the first time PortVision Plus has been opened, click the **Scan** button to locate DeviceMaster UP units on the network.

**Note:** The **Status** column for the DeviceMaster UP must display **ON-LINE** before you can go to the next step.

4. Right-click the DeviceMaster UP for which you want to program network information and click the **Configure Device** menu option.
5. Optionally, rename the device in the **Device Name** box.
6. If necessary, click **This device is on the local network**.
7. Change the device network properties as required for your site.

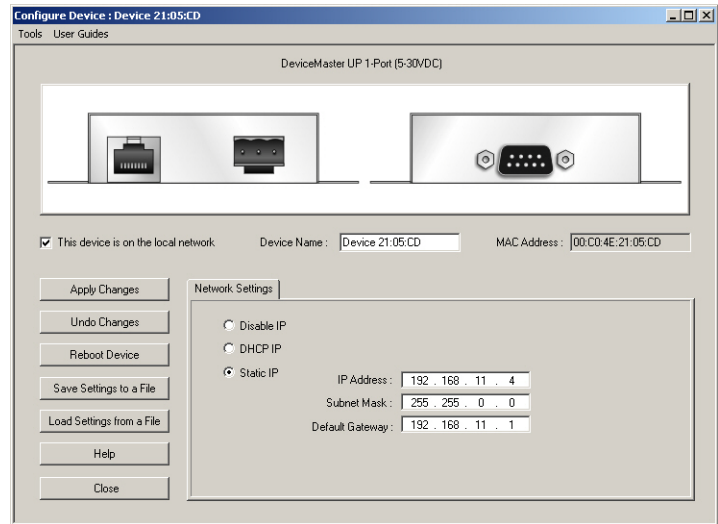

<b>Disable IP</b>	Click this option if you want to run the device using the MAC addressing scheme. <b>EtherNet/IP Users:</b> The DeviceMaster UP does not support <b>Disable IP</b> .
<b>DHCP IP†</b>	Click this option if you want to use the DeviceMaster UP with DHCP. Make sure that you provide the MAC address of the DeviceMaster UP to the network administrator.
<b>Static IP†</b>	Click this option to program a static IP address and type the appropriate IP address, subnet mask, and default gateway values for your site in the provided boxes.
†	<b>PROFINET CbA:</b> The network address entered here must match the IP address entered in SIMATIC iMap. See the <a href="#">DeviceMaster UP PROFINET CbA User Guide</a> for information about assigning addresses.
†	<b>PROFINET IO:</b> The network address entered here must match the IP address entered in SIMATIC Step7. See the <a href="#">DeviceMaster UP PROFINET IO Installation Quick Start</a> for information about assigning addresses.

8. Click **Apply Changes** and then **Close**. It may take up to a minute for the DeviceMaster UP status return to **ON-LINE**.



9. If applicable, check your firmware version to make sure that it is the latest version using the next subsection, [Checking the Protocol Firmware Version](#).
10. If necessary, use [Uploading Protocol-Specific Firmware on the DeviceMaster UP on Page 26](#) to update or load the firmware for your DeviceMaster UP.

## Checking the Protocol Firmware Version

Use PortVision Plus to check the firmware version before configuring the ports.

Depending on the model you purchased, the DeviceMaster UP may or may not have the protocol firmware loaded.

**Note:** Models that have a protocol loaded on the DeviceMaster UP are identified in PortVision Plus and the DeviceMaster UP is labeled accordingly.

The following procedure shows how to use PortVision Plus to check the firmware version on the DeviceMaster UP and check for the latest files.

**Note:** If you have not done so, install PortVision Plus ([Installing PortVision Plus on Page 23](#)).

1. Start PortVision Plus by double-clicking the PortVision Plus desktop icon or click **Start > Programs > Control > PortVision Plus**.
2. Examine the *List View* pane to see if or/and what version of the firmware is loaded on the DeviceMaster UP. If you see SocketServer or NS-Link as the *Software Version*, you must load the appropriate firmware for your protocol.

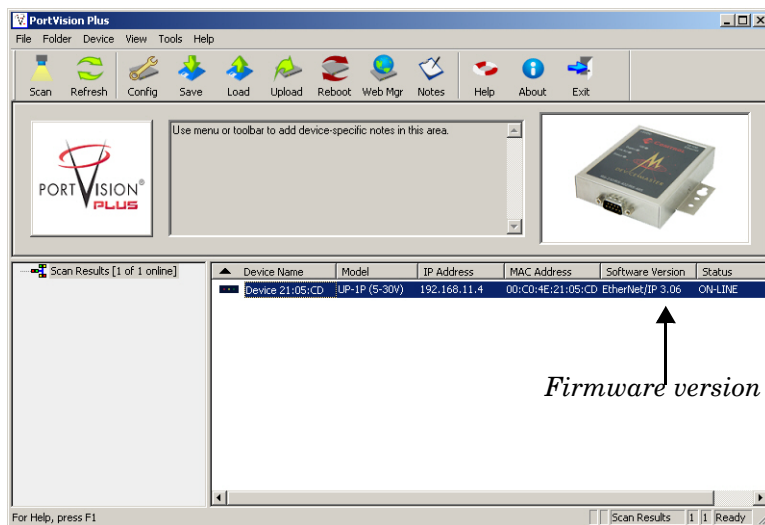

3. Check the Control web site to see if there is a later version available using the appropriate link.
  - [EtherNet/IP](#)
  - [Modbus/TCP](#)
  - [PROFINET CbA](#)
  - [PROFINET IO](#)
4. If applicable, download the latest version and go to [Step 2](#) in [Uploading Protocol-Specific Firmware on the DeviceMaster UP on Page 26](#).

## Uploading Protocol-Specific Firmware on the DeviceMaster UP

Some DeviceMaster UP models come from the factory with SocketServer firmware, which provides an interface to TCP/IP socket mode configuration and services, installed on the device.

If your DeviceMaster UP contains SocketServer and you want to configure one of the following environments, you must replace SocketServer with protocol-specific firmware:

- EtherNet/IP
- Modbus/TCP
- PROFINET CbA
- PROFINET IO

The CD shipped with the DeviceMaster UP contains the required firmware and support files in a self-installing (.msi) file or you can download the latest from the Internet

Use the following procedure to update the firmware on your DeviceMaster UP for the appropriate protocol. See [Locating Software and Documentation on Page 6](#), if you need to download the .msi file for your protocol.

**Note:** *If you have not done so, install PortVision Plus ([Installing PortVision Plus on Page 23](#)) and extract the firmware.msi file.*

1. Start PortVision Plus by double-clicking the PortVision Plus desktop icon or click **Start > Programs > Control > PortVision Plus**.
2. Right-click on the device or devices for which you want to upload firmware and click the **Upload Firmware** menu option.

Optionally, you can high-light a device and use the **Load** button.

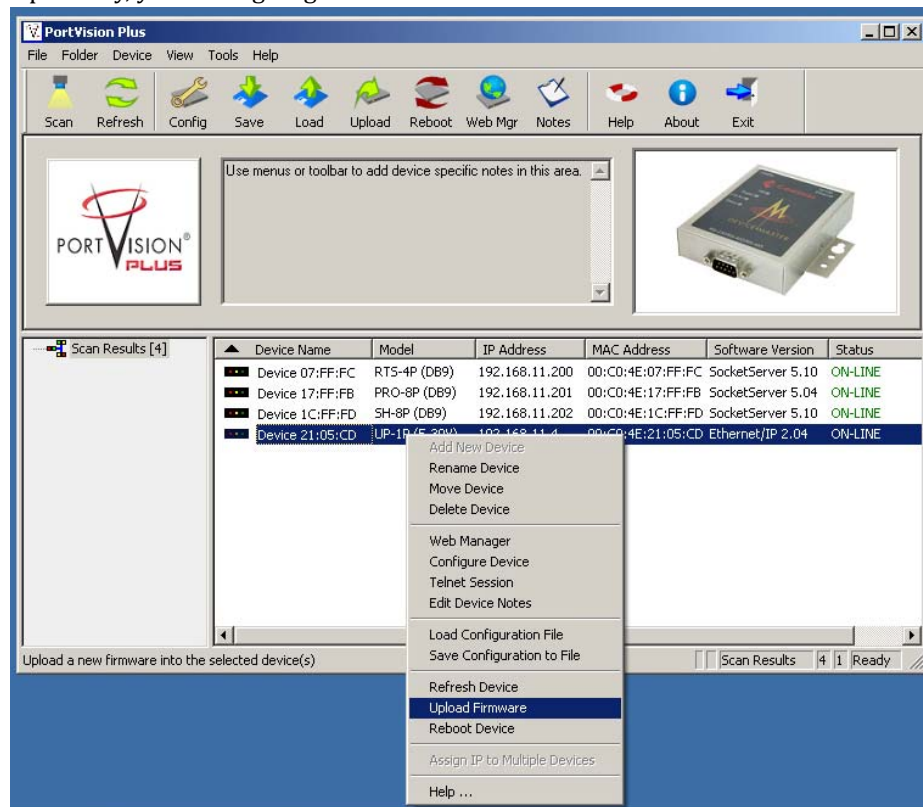

3. Browse and select the appropriate firmware (.bin) file and click **Open**.

4. Click **Yes** to upload the firmware.

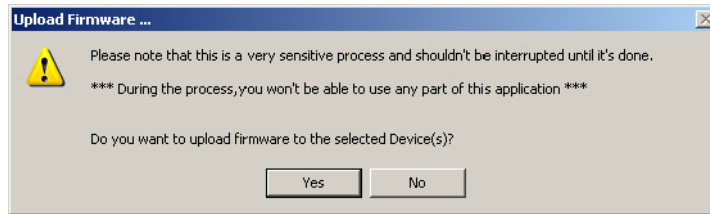

5. Click **OK** to the advisory message about waiting until the DeviceMaster UP is on-line and in the next minute the DeviceMaster UP unit or units should display **ON-LINE** in the **Status** field
6. Go to the appropriate *Quick Start* for your protocol for information about configuring the serial port or ports using the web page and programming your PLCs. See [Locating Software and Documentation on Page 6](#) to locate the document for your protocol or refer to the installation CD shipped with the DeviceMaster UP.

If you are planning on installing multiple DeviceMaster UPs (EtherNet/IP or Modbus/TCP), you may want to use the *Save/Load Configuration File* feature in PortVision Plus.

A configuration file can contain network settings and protocol settings. Refer to the PortVision Plus help system for information about saving and loading configuration files.

7. After configuring the serial port characteristics and preparing your PLC programs, you can use the next section in this guide, to attach the serial device or devices.



# Connecting Serial Devices

This section discusses connecting your serial devices to the DeviceMaster UP. It also provides you with information to build serial cables and loopback connectors to test the serial ports.

Use the appropriate procedure to connect asynchronous serial devices to the DeviceMaster UP ports.

- [DB9 and RJ45 Connectors](#)
- [Serial Terminals \(4\) - 1E on Page 33](#)
- [Serial Terminals \(8\) - 2E on Page 36](#)

**Note:** Go to [Building the Serial Ribbon Cable on Page 12](#) for connector information for the DeviceMaster UP 1-Port Embedded adapter.

## DB9 and RJ45 Connectors

---

---

1. Connect your serial devices to the appropriate serial port on the DeviceMaster UP using the appropriate cable. You can build your own DB9 or RJ45 cables using the appropriate discussion:
  - [DB9 Connectors](#) (below)
  - [RJ45 Connectors on Page 31](#)
2. Verify that the devices are communicating properly. Go to the appropriate table for information about the LEDs, which may provide information about the installation.
  - [1-Port Enclosed LED Descriptions on Page 11](#)
  - [1-Port Embedded LED Descriptions on Page 15](#)
  - [2-Port DB9 LED Descriptions](#)
  - [4-Port LED Descriptions on Page 20](#)

## DB9 Connectors

You can build your own null-modem or straight-through DB9 serial cables using the following subsections..

<i>DB9 Connector Pinouts</i>			
Pin	RS-232	RS-422 <i>RS-485 Full-Duplex (Master/Slave)†</i>	RS-485 Half-Duplex
1	DCD	Not used	Not used
2	RxD	RxD-	Not used
3	TxD	TxD-	TRxD-
4	DTR	Not used	Not used
5	GND	Not used††	Not used†
6	DSR	Not used	Not used
7	RTS	TxD+	TRxD+
8	CTS	RxD+	Not used
9	RI	Not used	Not Used
† Only 2-port models support RS-485 full-duplex.			
†† Pin 5 is tied to ground on the board, but is not used in the cable.			

Refer to the hardware manufacturer’s installation documentation if you need help with connector pinouts or cabling for the serial device.

This illustrates the DB9 connector signals.

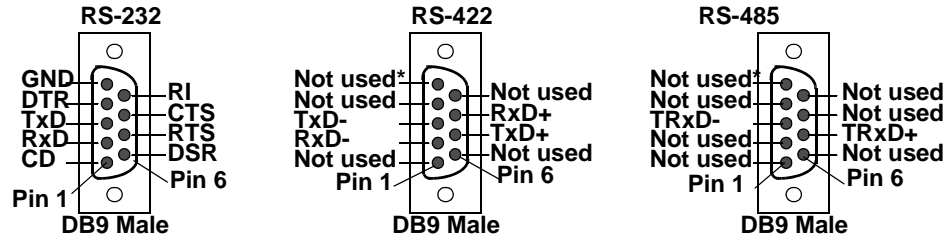

\* Pin 5 is tied to ground on the board, but is not used in the cable.

DB9 Null-Modem Cables (RS-232)

Use the following figure if you need to build an RS-232 null-modem cable. A null-modem cable is required for connecting DTE devices.

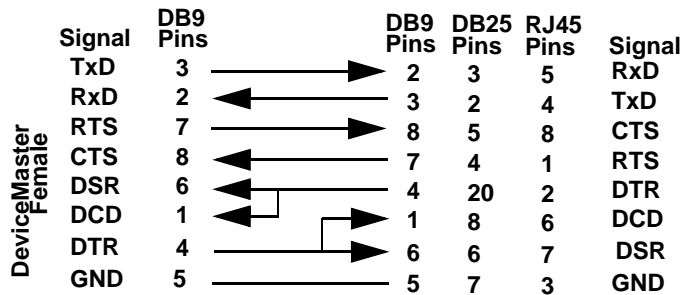

**Note:** You may want to purchase or build a straight-through cable and purchase a null-modem adapter. For example, a null-modem cable can be used to connect COM2 of one PC to COM2 of another PC.

DB9 Null-Modem Cables (RS-422)

Use the following figure if you need to build an RS-422 null-modem cable.

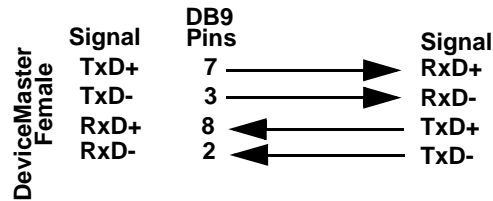

**Note:** RS-422 pinouts are not standardized. Each peripheral manufacturer uses different pinouts. Please refer to the documentation for the peripheral to determine the pinouts for the signals above.

DB9 Straight-Through Cables (RS-232/485)

Use the following figure if you need to build an RS-232 or RS-485 straight-through cable. Straight-through cables are used to connect modems and other DCE devices. For example, a straight-through cable can be used to connect COM2 to a modem.

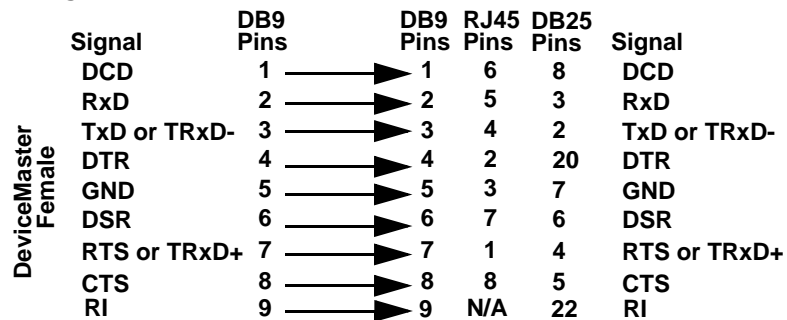

DB9 Loopback Plugs

Loopback connectors are DB9 female serial port plugs, with pins wired together as shown, that are used in conjunction with application software (Test Terminal) to test serial ports. The DeviceMaster UP is shipped with a single loopback plug (RS-232/422).

Wire the following pins together to build additional plugs or replace a missing RS-232 loopback plug:

- Pins 1 to 4 to 6
- Pins 2 to 3
- Pins 7 to 8 to 9

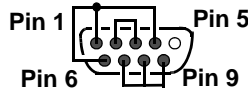

**RS-232 Only (Back View)** The RS-232 loopback plug also works for RS-422.

Wire the following pins together for an RS-422 loopback plug:

- Pins 2 to 3
- Pins 7 to 8

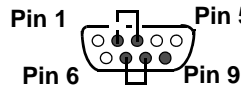

**RS-422 Only (Back View)**

RJ45 Connectors

You can build your own null-modem or straight-through RJ45 serial cables if you are using the DB9 to RJ45 adapters.

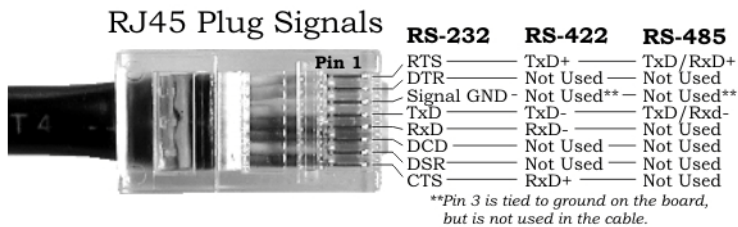

Pin	RS-232	RS-422	RS-485
1	RTS	TxD+	TRxD+
2	DTR	Not used	Not used
3	Signal GND	Not used†	Not used†
4	TxD	TxD-	TRxD-
5	RxD	RxD-	Not used
6	DCD	Not used	Not used
7	DSR	Not used	Not used
8	CTS	RxD+	Not used

† Pin 3 is tied to ground on the board, but is not used in the cable.

RJ45 Null-Modem Cables (RS-232)

Use the following figure if you need to build an RS-232 null-modem cable. A null-modem cable is required for connecting DTE devices.

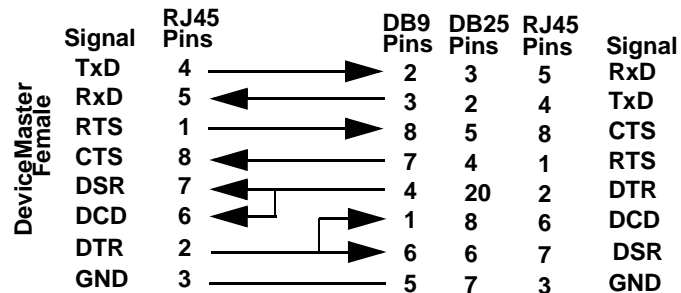

**Note:** You may want to purchase or build a straight-through cable and purchase a null-modem adapter. For example, a null-modem cable can be used to connect COM2 of one PC to COM2 of another PC.

RJ45 Null-Modem Cables (RS-422)

Use the following figure if you need to build an RS-422 null-modem RJ45 cable. A null-modem cable is required for connecting DTE devices.

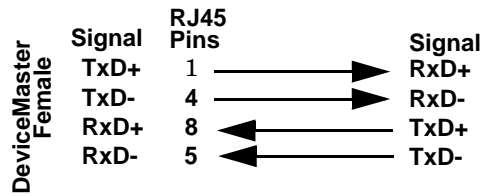

**Note:** RS-422 pinouts are not standardized. Each peripheral manufacturer uses different pinouts. Please refer to the documentation for the peripheral to determine the pinouts for the signals above.

RJ45 Straight-Through Cables (RS-232/485)

Use the following figure if you need to build an RS-232 or RS-485 straight-through cable. Straight-through cables are used to connect modems and other DCE devices. For example, a straight-through cable can be used to connect COM2 of one PC to COM2 to a modem.

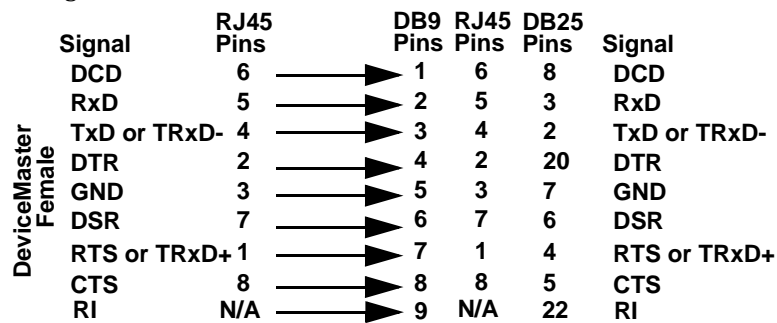

RJ45 Loopback Plugs

Loopback connectors are RJ45 serial port plugs, with pins wired together as shown, that are used in conjunction with application software (Test Terminal) to test serial ports. The DeviceMaster UP is shipped with a single loopback plug (RS-232/422).

- Pins 4 to 5
- Pins 1 to 8
- Pins 2 to 6 to 7

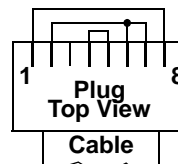

The RS-232 loopback plug also works for RS-422.

RJ45 RS-485 Test Cable

You can use a straight-through cable as illustrated previously, or build your own cable.

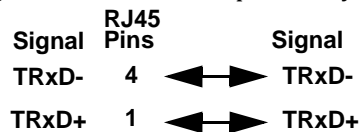

**Note:** RS-422 pinouts are not standardized. Each peripheral manufacturer uses different pinouts. Please refer to the documentation for the peripheral to determine the pinouts for the signals above.



## Serial Terminals (4) - 1E

Use the following information to connect the DeviceMaster UP 2-port 1E with serial terminals.

1. Connect your serial devices to the appropriate serial port on the DeviceMaster UP using the appropriate cable. You can build your own cables or loopbacks using the appropriate discussions.

**Note:** Refer to the hardware manufacturer's installation documentation if you need help with connector pinouts or cabling for the serial device.

2. Verify that the devices are communicating properly. Use the LED description table on Page 17 if you need information about the LEDs.

### Serial Terminal (4) Connectors

Use the following table or drawings for signal information. The signals for **SERIAL2** are the same as **SERIAL1**.

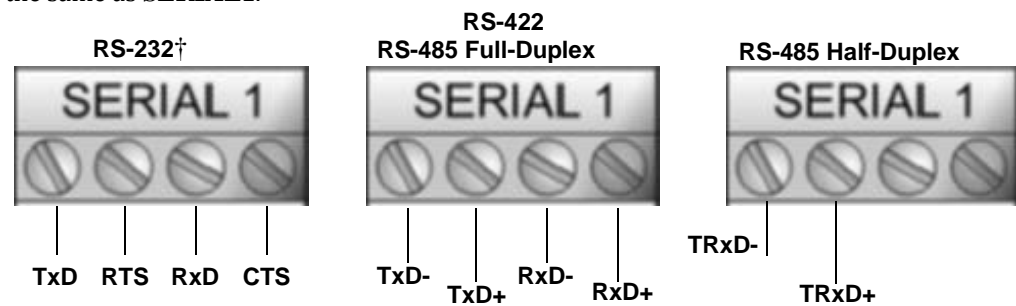

† † RS-232 ground must be connected to the appropriate signal ground terminal.

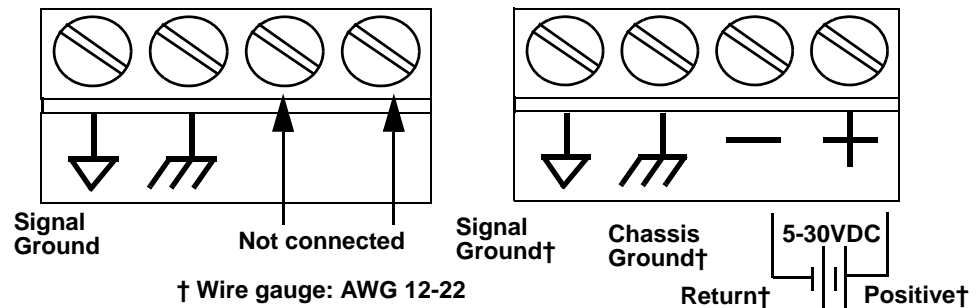

<b>RS-232†</b>	TxD	RTS	RxD	CTS
<b>RS-422/RS-485 Full-Duplex</b>	TxD-	TxD+	RxD-	RxD+
<b>RS-485 Half-Duplex</b>	TRxD-	TRxD+		

† RS-232 ground must be connected to the appropriate signal ground terminal.

*Serial Terminal (4)  
Null-Modem Cables  
(RS-232)*

An RS-232 null-modem cable is required for connecting DTE devices.

RS-232 Null-Modem Cable

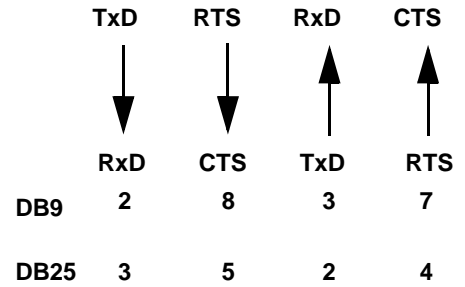

*Serial Terminal (4)  
Null-Modem Cables  
(RS-422)*

An RS-422 null-modem cable is required for connecting DTE devices.

**Note:** RS-422 pinouts are not standardized. Each peripheral manufacturer uses different pinouts. Please refer to the documentation for the peripheral to determine the pinouts for the signals above.

RS-422 Null-Modem Cable

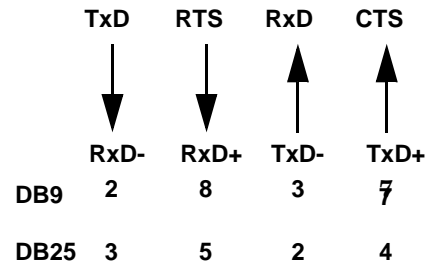

*Serial Terminal (4)  
Straight-Through  
Cables (RS-232/485)*

RS-232 or RS-485 straight-through cables are used to connect modems and other DCE devices.

RS-232/422 Straight-Through Cable

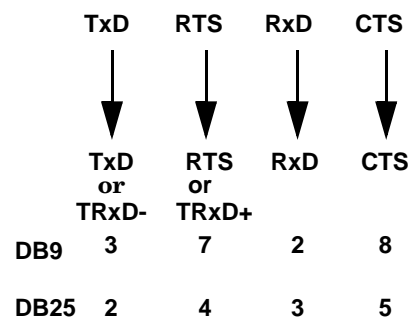
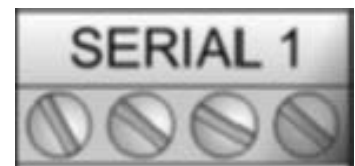

*1E Loopback Signals*

Use this drawing to wire a loopback, which is used in conjunction with application software (Test Terminal) to test serial ports.

See the [NS-Link User Guide for Windows](#) about using Test Terminal to test the serial ports. Optionally, this information is on the *Software and Documentation CD* shipped with the product.

Wire the terminals together to create a loopback.

- TxD to RxD
- RTS to CTS

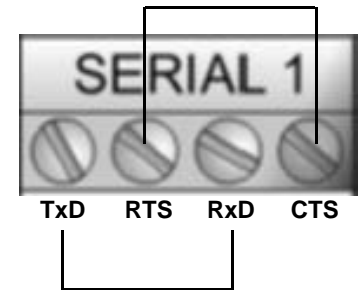

## Serial Terminals (8) - 2E

Use the following information to connect the DeviceMaster UP 2-port 2E with serial terminals.

1. Connect your serial devices to the appropriate serial port on the DeviceMaster UP using the appropriate cable.

**Note:** Refer to the hardware manufacturer's installation documentation if you need help with connector pinouts or cabling for the serial device.

2. Verify that the devices are communicating properly. Use the LED description table on Page 17 if you need information about the LEDs.

### Serial Terminal (8) Connectors

Use the following drawings or table for signal information. The signals for **SERIAL2** are the same as **SERIAL1**.

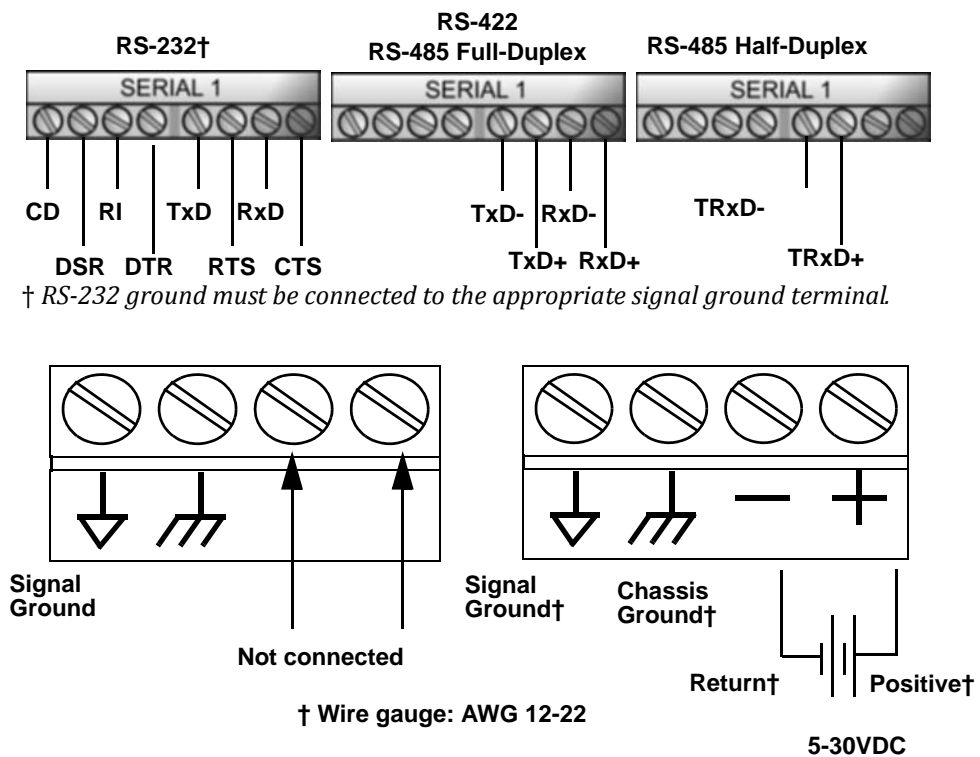

<b>RS-232</b>	CD	DSR	RI	DTR	TxD	RTS	RxD	CTS
<b>RS-422/RS-485 Full-Duplex</b>	N/A	N/A	N/A	N/A	TxD-	TxD+	RxD-	RxD+
<b>RS-485 Half-Duplex</b>	N/A	N/A	N/A	N/A	TRxD-	TRxD+	N/A	N/A

† RS-232 ground must be connected to the appropriate signal ground terminal

*Serial Terminal (8) Null-Modem Cables (RS-232)*

An RS-232 null-modem cable is required for connecting DTE devices.

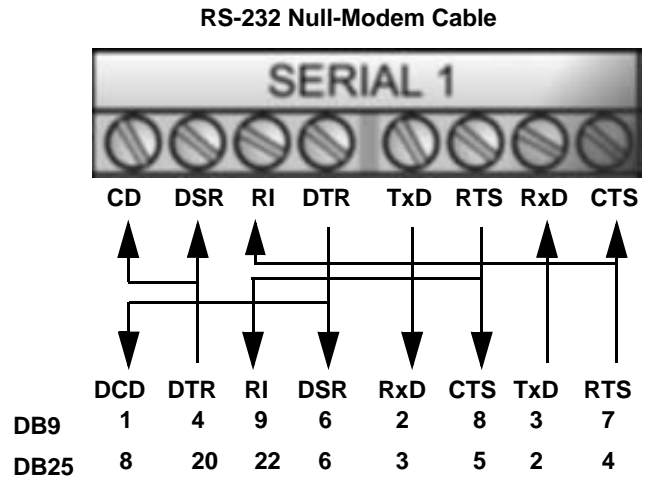

*Serial Terminal (8) Null-Modem Cables (RS-422)*

An RS-422 null-modem cable is required for connecting DTE devices.

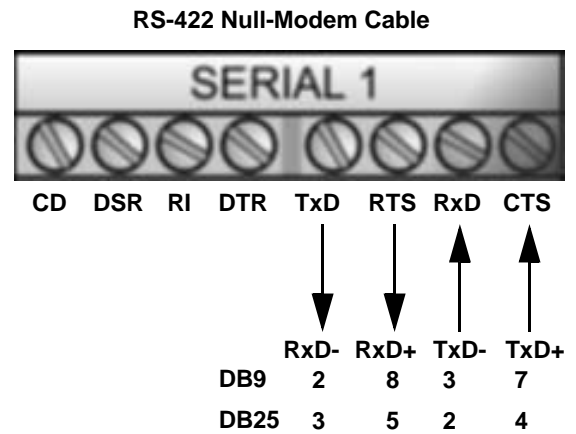

*Serial Terminal (8) Straight-Through Cables (RS-232/485)*

RS-232 or RS-485 straight-through cables are used to connect modems and other DCE devices.

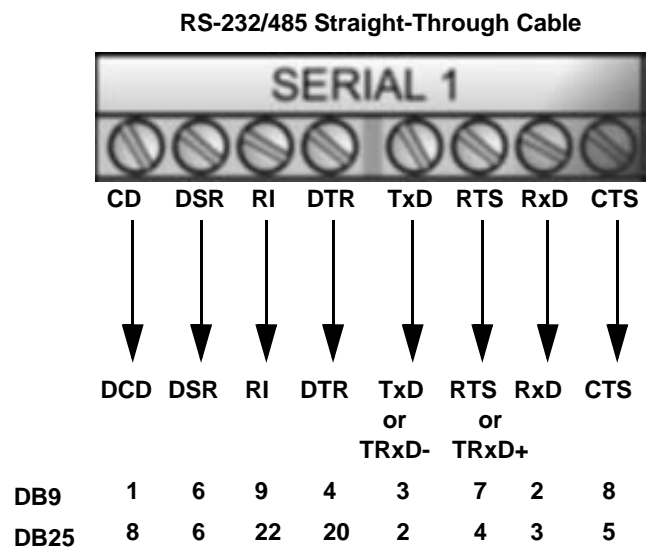

*2E Loopback Signals*

Use the drawing below to wire a loopback, which is used in conjunction with application software (Test Terminal) to test serial ports.

See the [NS-Link User Guide for Windows](#) about using Test Terminal to test the serial ports. Optionally, this information is on the *Software and Documentation* CD shipped with the product

Wire the terminals together to create a loopback.

- TxD to RxD
- RTS to CTS to RI
- DTR to CD to DSR

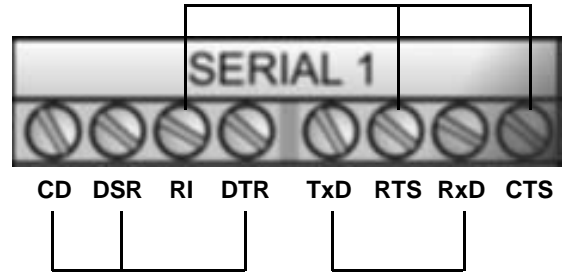

# Hardware Specifications

The following subsections contain specifications and safety notices for the DeviceMaster UP family.

RoHS compliant products conform to EU Directive 2002/95/EC. These products do not contain any restricted substances (lead, cadmium, hexavalent chromium, mercury, PBB, and PBDE) except as specifically provided in the Directive.

## Locating DeviceMaster UP Specifications

---

---

Specifications can be found on the Control web site at: <http://www.control.com/products/family/dmup>.

## Serial Communications

---

---

This table provides DeviceMaster UP serial communications specifications.

Serial Communications	
Interface	RS-232, RS-422, and RS-485
Serial connector types: 1-Port standard 1-Port embedded 2-port 4-Port	DB9 Male Header, IDC10 Screw terminal or DB9 DB9 (and DB9 to RJ45 adapter)
Baud rate/port Receive buffer Transmit buffer	300 to 230.4K bps 1024 bytes 256 bytes
Software control: Data bits Parity Stop bits Flow control	7 or 8 Odd, even, none 1 or 2 Hardware or software
Network default values: IP address Subnet mask Gateway	192.168.250.250 255.255.0.0 192.168.250.1
Network protocols	TCP/IP and UDP Socket services, BOOTP, TFTP, ICMP, ARP, SNMP (MIB-II), Telnet, HTTP, DHCP/RARP/Ping, RFC 1006
SNMP support	Monitoring only

## External Power Supply Specifications

This subsection discusses information that you may need if you wish to use your own external power supplies.

- [1-Port on Page 40](#)
- [2-Port \(Serial Terminals\) on Page 40](#)
- [2-Port \(DB9\) on Page 40](#)
- [4-Port on Page 41](#)

### 1-Port

This table provides specifications for the power supply shipped with the DeviceMaster UP 1-port

Control Power Supply: 1-Port 5-30VDC	
Input line frequency	43-63 Hz
Input line voltage	90-260 VAC
Output voltage	24VDC
Output current	500 mA @ 24VDC

This table provides the specifications, if you intend on using your own power supply.

External Power Supply: 1-Port 5-30VDC	
Output voltage†	5-30VDC
Current†	100 mA (Min) @ 24VDC
Power	2.5 W
† Any power supply that meets current consumption, voltage, power, and connector pinouts requirements can be used.	

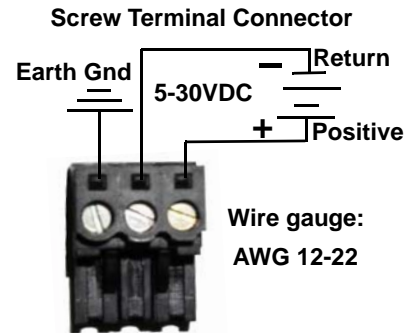

### 2-Port (Serial Terminals)

This table provides the specifications to purchase a power supply for a DeviceMaster UP 2-port 1E/2E model with serial terminal connectors..

External Power Supply: 2-Port (Serial Terminal Connectors) 5-30VDC	
Output voltage†	5-30VDC
Current†	100 mA (Min) @ 24VDC
Power	2.5 W
† Any power supply that meets current consumption, voltage, power, and connector pinouts requirements can be used.	

### 2-Port (DB9)

This table provides the specifications to purchase a power supply for a DeviceMaster UP 2-port 1E/2E model with serial terminal connectors..

External Power Supply: 2-Port (Serial Terminal Connectors) 6-30VDC	
Output voltage†	6-30VDC
Current†	100 mA (Min) @ 24VDC
Power	2.5 W
† Any power supply that meets current consumption, voltage, power, and connector pinouts requirements can be used.	



**4-Port**

This table provides the specifications for the power supply shipped with the DeviceMaster UP 4-port

<b>Control Power Supply: 4-Port</b>	
Input line frequency	47 - 63 Hz
Input line voltage	90 - 260 VAC
Output voltage	24VDC
Output current	500 mA @ 24VDC

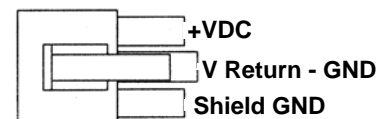

**Housing Molex P/N:**  
39-01-4030  
**Pins Molex P/N:**  
44485-1211

This table provides the specifications, if you intend on using your own power supply.

<b>External Power Supply: 4-Port</b>	
Output voltage†	9-30VDC
Current†	200 mA (Min) @ 24VDC
Power	4.8 W
† Any power supply that meets current consumption, voltage, power, and connector pinouts requirements can be used.	

## DeviceMaster UP Product Pictures

---

This subsection provides you with detailed pictures of the different DeviceMaster UP models:

- [1-Port \(DB9\) on Page 42](#)
- [1-Port Embedded on Page 43](#)
- [2-Port \(Single Ethernet Port\) with Serial Terminals on Page 43](#)
- [2-Port \(Dual Ethernet Ports\) with Serial Terminals on Page 43](#)
- [2-Port \(Single Ethernet Port\) DB9 on Page 44](#)
- [2-Port \(Dual Ethernet Ports\) DB9 on Page 44](#)
- [4-Port \(DB9\) on Page 44](#)

See the appropriate discussion in the [Hardware Installation](#) section (Page 9) for information about the LEDs.

**1-Port (DB9)**

This illustrates the DeviceMaster UP 1-Port.



**1-Port Embedded**

This illustrates the DeviceMaster UP 1-port Embedded system that uses a 5-30VDC power supply. See [1-Port on Page 40](#) so that you can provide a power supply for the DeviceMaster UP.

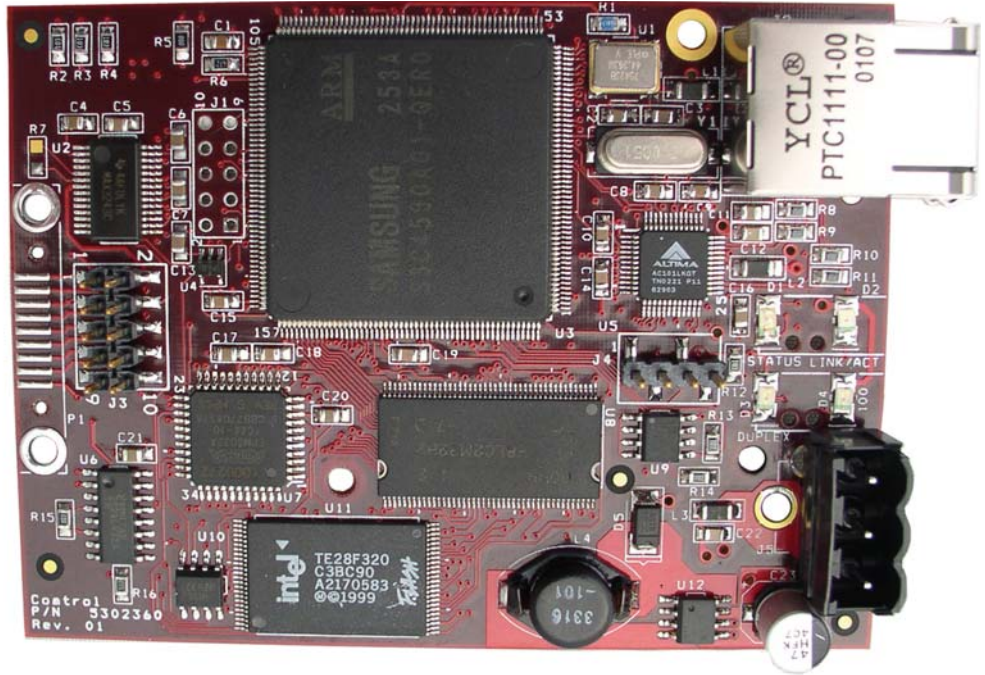

**2-Port (Single Ethernet Port) with Serial Terminals**

The DeviceMaster UP 2-port 1E with serial terminals uses a 5-30VDC power supply. See [2-Port \(Serial Terminals\) on Page 40](#) for information about the power supply.

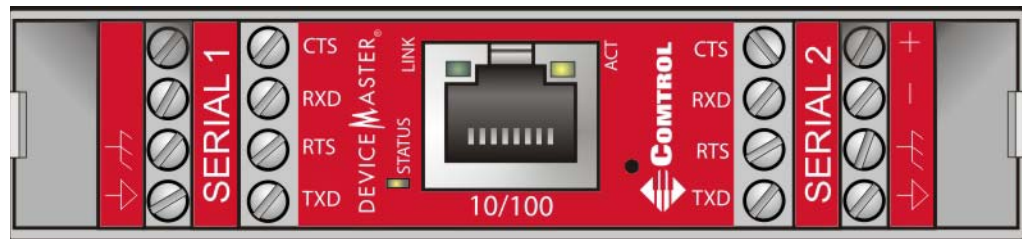

**2-Port (Dual Ethernet Ports) with Serial Terminals**

The DeviceMaster UP 2-port 2E with serial terminals uses a 5-30VDC power supply. See [2-Port \(Serial Terminals\) on Page 40](#) for information about the power supply.

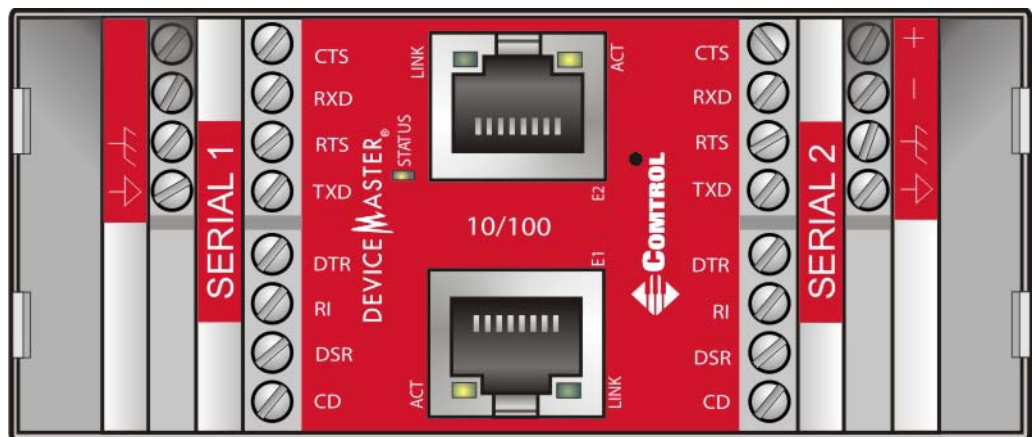

**2-Port (Single Ethernet Port) DB9**

The DeviceMaster UP 2-port 1E DB9 uses a 5-30VDC power supply. See [2-Port \(DB9\) on Page 40](#) for information about the power supply.



**2-Port (Dual Ethernet Ports) DB9**

The DeviceMaster UP 2-port 2E DB9 uses a 5-30VDC power supply. See [2-Port \(DB9\) on Page 40](#) for information about the power supply.



**4-Port (DB9)**

The **PWR** LED for the DeviceMaster UP 4 with DB9 ports is on the other side of the unit



---

---

## Notices

---

---

### Radio Frequency Interference (RFI) (FCC 15.105)

This equipment has been tested and found to comply with the limits for Class A digital devices pursuant to Part 15 of the FCC Rules.

This equipment generates, uses, and can radiate radio frequency energy, and if not installed and used in accordance with the instruction manual, may cause harmful interference to radio communications. However, there is no guarantee that interference will not occur in a particular installation. If this equipment does cause harmful interference to radio or television reception, which can be determined by turning the equipment off and on, the user is encouraged to try and correct the interference by one or more of the following measures:

- Reorient or relocate the receiving antenna.
- Increase the separation between the equipment and the receiver.
- Connect the equipment into an outlet on a circuit different from that to which the receiver is connected.
- Consult the dealer or an experienced radio/TV technician for help.

### Labeling Requirements (FCC 15.19)

This equipment complies with part 15 of FCC rules. Operation is subject to the following two conditions:

- This device may not cause harmful interference.
- This device must accept any interference received, including interference that may cause undesired operation.

### Modifications (FCC 15.21)

Changes or modifications to this equipment not expressly approved by Control Corporation may void the user's authority to operate this equipment.

### Serial Cables (FCC 15.27)

This equipment is certified for Class A operation when used with unshielded cables on models with the RJ45 connectors and with shielded cables on all models with DB9 connectors.

### Underwriters Laboratory

This equipment is Underwriters Laboratory "UL" listed.

### Important Safety Information



To avoid contact with electrical current:

- Never install electrical wiring during an electrical storm.
- Never install the power plug in wet locations.
- Use a screwdriver and other tools with insulated handles.



# RedBoot Procedures

Use this section as a reference if you want to perform tasks in Redboot. Typically, most of these procedures can be performed using PortVision Plus.

## Overview

---

---

You can use a *serial* connection between Port 1 on the DeviceMaster UP and a COM port on a PC. If you plan on using the serial method, you will need a null modem cable and a terminal program installed and configured on the PC.

**Note:** Use the serial connection method, if the DeviceMaster UP is not on the same Ethernet network segment as the PC.

You can use a *telnet* connection, if the DeviceMaster UP is locally accessible by Ethernet. If necessary, see [Establishing a Serial Connection on Page 47](#) or [Establishing a Telnet Connection on Page 48](#) to disable the Bootloader before performing any of these procedures.

## Establishing a Serial Connection

Use the following procedure to set up serial connection with a terminal server program (for example, Test Terminal (WCom2), HyperTerminal and the DeviceMaster UP. Test Terminal (WCom2) is available in PortVision Plus or you can also install the Control Utility package.

1. Connect a null-modem cable from an available COM port on your PC to **Port 1** on the DeviceMaster UP.

**Note:** See [Connecting Serial Devices on Page 29](#) to build a null-modem cable.

2. Configure a terminal server program (such as, HyperTerminal) to the following values:

- Bits per second = 57600
- Data bits = 8
- Parity = None
- Stop bits = 1
- Flow control = None

3. Reset the DeviceMaster UP.

**Note:** Disconnect and reconnect the power cable (external power supply).

4. Immediately type **#!DM** and press **Enter** in the terminal program.

5. At the **RedBoot>** prompt, type **dis**, and press **Enter**.

**Note:** If you do not disable the loading feature of the Bootloader within the time-out period (default is fifteen seconds), an application will be loaded from flash and started. If this happens, repeat Steps 3 through 5. The **#!DM** command is the only case-sensitive command and must be in uppercase.

```
#!DM
RedBoot>dis
Loading disabled
```

6. Verify that the system responds with a **Loading disabled** message.

7. Go to the appropriate task:
  - [Determining the Network Settings on Page 49](#)
  - [Configuring the Network Settings on Page 49](#)
  - [Determining the Bootloader Version on Page 50](#)
  - [Resetting the DeviceMaster UP on Page 50](#)
  - [Uploading Firmware on Page 51](#)
  - [Configuring Passwords on Page 54](#)
  - [Redboot Command Overview on Page 55.](#)

### Establishing a Telnet Connection

Use the following procedure to telnet to the DeviceMaster UP.

1. Open a telnet session, enter the DeviceMaster UP IP address. If using Windows, open a **Command** window and type **telnet [ip\_address]**.  
*Note: Press the **Enter** key if you have not programmed a password or use the password previously configured. The DeviceMaster UP does not come pre-programmed with a password.*
2. Type **reset**, and close the session.
3. Open a new telnet session, enter the DeviceMaster UP IP address, and the password.
4. Type **dis** to disable the Bootloader.

```
*****  
**  
**  Comtrol DeviceMaster Bootloader Version 3.05  
**  RedBoot(tm) environment - built 08:13:02, Apr   4 2008  
**  Platform: Comtrol DeviceMaster (ARM 7TDMI)  
**  Portions Copyright (C) 2000. Red Hat, Inc.  
**  Portions Copyright (C) 2001-2008 Comtrol Corp.  
*****  
  
FLASH:  64 blocks of 65536 bytes each  
FLASH:  4194304 bytes (0x05000000 - 0x05400000)  
RAM:    8126464 bytes (0x00000000 - 0x007c0000)  
RedBoot> dis  
Loading disabled  
RedBoot> _
```

5. Verify that the system responds with a **Loading disabled** message.
6. Go to the appropriate task:
  - [Determining the Network Settings on Page 49](#)
  - [Configuring the Network Settings on Page 49](#)
  - [Determining the Bootloader Version on Page 50](#)
  - [Resetting the DeviceMaster UP on Page 50](#)
  - [Uploading Firmware on Page 51](#)
  - [Configuring Passwords on Page 54](#)
  - [Redboot Command Overview on Page 55.](#)



## Determining the Network Settings

- If you are not sure what the network information is on a DeviceMaster UP, you can perform the following procedure.
1. Establish communications with the DeviceMaster UP using the serial (Page 47) method.
2. At the **RedBoot** prompt, type **ip**.
- Default Network Settings
- IP address:  
192.168.250.250
- Subnet mask:  
255.255.0.0
- Gateway address:
- ```
RedBoot>dis
Loading disabled
RedBoot> ip
IP Config: IpAddr 192.168.250.250 IpMask 255.255.0.0 IpGate 192.168.250.1
RedBoot>
```

The IP address, subnet mask, and IP gateway values will display.

**Note:** *Optionally, you can install PortVision Plus on a Windows system on the network and see the IP information in the List View pane.*

## Configuring the Network Settings

The following subsections show you how to establish a communications link with Redboot on the DeviceMaster UP, by using one of these methods:

- *Serial connection* between Port 1 on the DeviceMaster UP and a COM port on a PC. If you do not know the IP address of the DeviceMaster UP you must use a serial connection to communicate with the DeviceMaster UP.
- *Telnet connection* requires that you know the IP address. In addition, the IP address must also be valid for the network to which it is attached. For example: The network segment must be 192.168.250.x to telnet to the DeviceMaster UP default IP.

**Note:** *Optionally, you can install PortVision Plus on a Windows system on the network and use the Configure Device window to configure network settings.*

Use the following procedure to program the IP address using Redboot.

1. Establish communications with the DeviceMaster UP using the serial (Page 47) or telnet (Page 48) method.
2. Enter **ip [addr mask gateway]** and press the **Enter** key to configure the IP address.  
*Where:*

**addr** = IP address you want to use

**mask** = matches you network subnet mask

**gateway** = assigned by your network administrator

*Make sure that each value is separated by a space.*

```
RedBoot>dis
Loading disabled
RedBoot> ip ###.###.###.### ###.###.###.### ###.###.###.###
RedBoot> ip
IP Config: IpAddr ###.###.###.### IpMask ###.###.###.### IpGate ###.###.###.###
RedBoot> reset
... Resetting
```

3. Verify that Redboot responds with your configured network information or reissue the command.
4. Type **reset** to reset the DeviceMaster UP, if you do not have any other related Redboot tasks.

## Determining the Bootloader Version

---

---

Use the following procedure to determine what Bootloader version is loaded in the DeviceMaster UP.

1. Establish communications with the DeviceMaster UP using the serial (Page 47) or telnet (Page 48) method.
2. At the **RedBoot** prompt, type **version**.

```
RedBoot> version
*****
**
** Control DeviceMaster Bootloader Version 3.05
** RedBoot(tm) environment - built 08:13:02, Apr 4 2008
** Platform: Control DeviceMaster (ARM 7TDMI)
** Portions Copyright (C) 2000. Red Hat, Inc.
** Portions Copyright (C) 2001-2008 Control Corp.
*****

FLASH: 64 blocks of 65536 bytes each
FLASH: 4194304 bytes (0x05000000 - 0x05400000)
RAM: 8126464 bytes (0x00000000 - 0x007c0000)
RedBoot>
```

The Bootloader information displays.

3. To update the Bootloader on the DeviceMaster UP, make sure that you download the latest version and see [Uploading Protocol-Specific Firmware on the DeviceMaster UP on Page 26](#).
4. Type **reset** to reset the DeviceMaster UP, if you do not have any other related Redboot tasks.

**Note:** *Optionally, you can install PortVision Plus on a Windows system on the network and see the Bootloader version in the List View pane. Reboot the DeviceMaster UP, right-click the DeviceMaster UP and click Refresh Device until the Bootloader version displays. The Bootloader version is only displayed for a few moments.*

## Resetting the DeviceMaster UP

---

---

When you have completed your tasks in Redboot, you must enter a **reset** command at the **RedBoot>** prompt for the DeviceMaster UP to begin operation.

**Note:** *The LEDs on the DeviceMaster UP will go through the power up sequence. The DeviceMaster UP has completed its reset cycle when the **Status** LED is lit and it stops flashing.*

## Uploading Firmware

Use the appropriate procedure for your environment:

- [Serial Method on Page 51](#)
- [Telnet Method on Page 52](#)

**Note:** *Optionally, you can install PortVision Plus on a Windows system on the network and upload firmware. PortVision Plus is the recommended method for uploading firmware.*

### Serial Method

The procedure for updating the Bootloader and the default application are the same, but the **.bin** files are unique.

1. Verify that you have the **.bin** file ([Locating Software and Documentation on Page 6](#)) and cable ([Establishing a Serial Connection on Page 47](#)).
2. Connect a null modem cable from an available COM port on your PC to **Port 1** on the DeviceMaster UP.
3. Start the terminal program and configure your terminal server program (for example, HyperTerminal) to the following values:
  - Bits per second = 57600
  - Data bits = 8
  - Parity = None
  - Stop bits = 1
  - Flow control = None
4. Reset the DeviceMaster UP (disconnect and reconnect the power cable).
5. Immediately type **#!DM** and press **Enter** in your terminal program.

```
#!DM
RedBoot>dis
Loading disabled
```

6. At the **RedBoot>** prompt, type **dis**, and press **Enter**.

**Note:** *If you are unsuccessful in disabling the Bootloader within ten seconds, type **reset**, **#!DM**, and **dis** again. The **#!DM** command is the only case-sensitive command and must be in uppercase.*

7. Verify that the system responds with an **Loading disabled** message.
8. Type **load -r -b 0 -m x** at the **RedBoot>** prompt and press **Enter**.

```
RedBoot> load -r -b 0 -m x
CC
```

9. Upload the file using Xmodem for the protocol. For example, if you are using HyperTerminal:
  - a. Click **Transfer**.
  - b. Click **Send File**.
  - c. Browse to the location where you stored the file from [Locating Software and Documentation on Page 6](#).
  - d. Click **Xmodem** as the protocol.

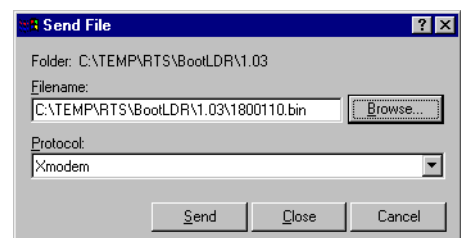

*The file name in this screen shows the Bootloader.*

- e. Click **Send**.

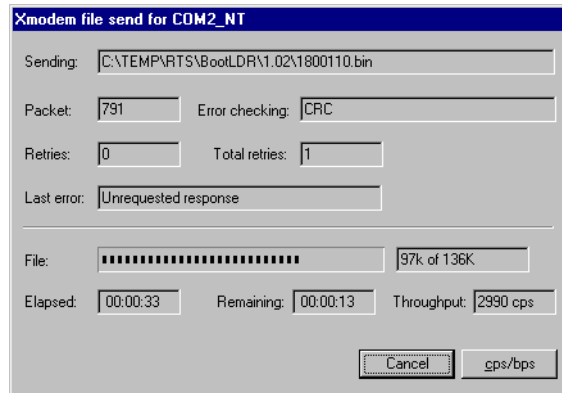

10. When the **RedBoot>** prompt appears (after approximately one minute for the Bootloader and approximately three minutes for the default application), type **go**.

```
CCCCCRaw load done: 542721 bytes read
Address range: 00000000-00084800, Entry point: 00000000,
xyzModem - CRC mode, 4241(SOH)/0(STX)/0(CAN) packets, 8 tries

... Erase from 0x05030000-0x050c0000: .....
... Program from 0x00000000-0x00084801 at 0x05060000: ...
... Erase from 0x050f0000-0x05400000: .
... Program from 0x007a0000-0x007b0000 at 0x053f0000: .
```

**Note:** In a few seconds, the ethernet and PWR LEDs cycle through a light sequence once and then upgrade is complete.

11. **If you updated the default application:** type, **fis list** and press **Enter** at the RedBoot> prompt

```
RedBoot> fis list
Name          FLASH addr  Mem addr    Length      Entry point
FIS_directory 0x053F0000  0x053F0000 0x00010000 0x00000000
default       0x05030000  0x00000000 0x00090000 0x00000000
RedBoot>
```

**Note:** You should see file information for a file called **default**. If you do not see this file, repeat the process starting with [Step 6](#).

12. Reset the DeviceMaster UP by typing **reset** at the RedBoot> prompt.

```
RedBoot> reset
...Resetting
```

**Note:** In a few seconds the ethernet and PWR LEDs cycle through a light sequence once and the update is complete.

13. Start your internet browser and enter the IP address of the DeviceMaster UP to verify that the new version of the default application loads.

## Telnet Method

Use the following procedure to update the Bootloader or the default application with telnet to the DeviceMaster UP.

**Note:** A TFTP server is required to perform firmware updates using Redboot.

1. Verify that you have the **.bin** file ([Locating Software and Documentation on Page 6](#)).
2. Open a telnet session, type **reset**, and close the session.

- Open a new telnet session and enter the DeviceMaster UP IP address.

```
$ telnet 192.168.250.250 ←————— Default IP Address
Trying 192.168.250.250...
Connected to 192.168.250.250.
Escape character is '^]'.

```

- Enter the webserver password.

**Note:** Press the **Enter** key if you have not programmed a password.

```
Password:
*****
**
** Control DeviceMaster Bootloader Version 3.05
** RedBoot(tm) environment - built 08:13:02, Apr 4 2008
** Platform: Control DeviceMaster (ARM 7TDMI)
** Portions Copyright (C) 2000. Red Hat, Inc.
** Portions Copyright (C) 2001-2008 Control Corp.
*****

FLASH: 64 blocks of 65536 bytes each
FLASH: 4194304 bytes (0x05000000 - 0x05400000)
RAM: 8126464 bytes (0x00000000 - 0x007c0000)
RedBoot>

```

- At the Redboot prompt: type **dis** and press **Enter** to disable the Bootloader.

```
RedBoot>dis
Loading disabled

```

- Verify that the system responds with an **Loading disabled** message.
- Load the file from a TFTP server using the following command and press the **Enter** key:

**load -r -b 0 -h <TFTP-Server\_IP\_Addr> <Downloaded\_File\_Name>**

**Note:** The default IP address is: **192.168.250.250**.

```
RedBoot> load -r -b 0 -h 192.168.250.1 1800110.bin
CCCCRaw load done: 139521 bytes read
Address range: 00000000-00022100, Entry point: 00000000.
xyzModem - Cksum mode, 1091(SOH)/0(STX)/0(CAN) packets, 6 retries
RedBoot>

```

- When the RedBoot> prompt appears (after approximately one minute if you are uploading the Bootloader and approximately three minutes if you are uploading the default application), type **go**.

```
RedBoot>go

```

**If uploading Bootloader:** In a few seconds the ethernet and PWR LEDs cycle through a light sequence once and the update is complete.

**If uploading the default application:**

- a. At the RedBoot> prompt, type: **fis list** and press **Enter**.

```
RedBoot> fis list
Name          FLASH addr  Mem addr    Length      Entry point
FIS_directory 0x053F0000  0x053F0000  0x00010000  0x00000000
default       0x05030000  0x00000000  0x00090000  0x00000000
RedBoot>
```

**Note:** You should see file information for a file called **default**. If you do not see this file, repeat the process starting with [Step 7](#).

- b. Reset the DeviceMaster UP by typing **reset** at the RedBoot> prompt.

**Note:** In a few seconds the ethernet and PWR LEDs cycle through a light sequence once.

- c. Start your internet browser and enter the IP address of the DeviceMaster UP to verify that the new version of the default application loads.

## Configuring Passwords

---

This section discusses how to configure a password for the web and telnet server.

**Note:** See the *PortVision Plus* or *socket Help* system for information about email notification.

Use the following procedure to establish the DeviceMaster UP password for the Web and telnet server. Establishing a password prevents unauthorized changes to the DeviceMaster UP configuration.

1. Establish communications with the DeviceMaster UP using the serial (Page 51) or telnet method (Page 48).
2. Type **password [your\_password]** and press **Enter**.

**Note:** If you forget your password, you can reprogram the password using the serial method which bypasses the password.

```
Password:
*****
**
** Comtrol DeviceMaster Bootloader Version 3.05
** RedBoot(tm) environment - built 08:13:02, Apr  4 2008
** Platform: Comtrol DeviceMaster (ARM 7TDMI)
** Portions Copyright (C) 2000. Red Hat, Inc.
** Portions Copyright (C) 2001-2008 Comtrol Corp.
*****

FLASH:  64 blocks of 65536 bytes each
FLASH:  4194304 bytes (0x05000000 - 0x05400000)
RAM:    8126464 bytes (0x00000000 - 0x007c0000)
RedBoot> dis
Loading disabled
RedBoot> password dev1357
Password 'dev1357'
RedBoot>
```

**Note:** The Bootloader version on your DeviceMaster UP may be different than the version displayed in this graphic.

See the **auth** command in the [Redboot Command Overview on Page 55](#) if you want to set up Web browser authentication.

## Redboot Command Overview

The following table is an overview of Redboot commands available. You can access the list of commands online by entering **help** and pressing the **Enter** key. For more detailed information, see the *eCos Reference Manual* that is located on the Control product CD or [download](#) it from the web.

| RedBoot Commands                                                                                              |                                                                                                                                                                                                                                                                                                                                                                                                                                                                                                                                                                     |
|---------------------------------------------------------------------------------------------------------------|---------------------------------------------------------------------------------------------------------------------------------------------------------------------------------------------------------------------------------------------------------------------------------------------------------------------------------------------------------------------------------------------------------------------------------------------------------------------------------------------------------------------------------------------------------------------|
| <b>auth</b><br>{noaccess, none, basic, md5, invalid}                                                          | Sets or displays web authentication. The default is set to <b>none</b> , which means that there is no authentication required to access the web server.<br><br>To deny access to the web server, click <b>noaccess</b> or <b>invalid</b> . If access is attempted, a message appears to notify the user that access is denied.<br><br>To configure the web server to request an un-encrypted password, click <b>basic</b> . To configure the web server to request an encrypted password, click <b>md5</b> . (Some browsers do not support the <b>md5</b> command.) |
| <b>boardrev</b> †                                                                                             | Displays board revision.                                                                                                                                                                                                                                                                                                                                                                                                                                                                                                                                            |
| <b>cache</b> [ON   OFF]                                                                                       | Manages machine caches.                                                                                                                                                                                                                                                                                                                                                                                                                                                                                                                                             |
| <b>chassis</b>                                                                                                | Displays chassis information.                                                                                                                                                                                                                                                                                                                                                                                                                                                                                                                                       |
| <b>disable</b>                                                                                                | Disables automatic load of the default application.                                                                                                                                                                                                                                                                                                                                                                                                                                                                                                                 |
| <b>dump -b &lt;location&gt; -l &lt;length&gt;</b>                                                             | Displays (hex dump) of a range of memory.                                                                                                                                                                                                                                                                                                                                                                                                                                                                                                                           |
| <b>fis</b> {cmds}                                                                                             | Manages flash images. See Chapter 2 of the <a href="#">eCos Reference Manual</a> for {cmds} information.                                                                                                                                                                                                                                                                                                                                                                                                                                                            |
| <b>go</b> [-w <timeout>] [entry]                                                                              | Executes code at a location.                                                                                                                                                                                                                                                                                                                                                                                                                                                                                                                                        |
| <b>help</b> <topic>                                                                                           | Displays available Redboot commands.                                                                                                                                                                                                                                                                                                                                                                                                                                                                                                                                |
| <b>ip</b> {addr mask gateway}                                                                                 | Displays or sets the IP address configuration.                                                                                                                                                                                                                                                                                                                                                                                                                                                                                                                      |
| <b>load</b> {-r} {-v} {-h <host>} {-m {TFTP   xyzmodem}} {-b <base_addr>} <file_name>                         | Loads a file from TFTP server or XModem.                                                                                                                                                                                                                                                                                                                                                                                                                                                                                                                            |
| <b>loop</b> 232 422[int port-number]                                                                          | Runs loopback test on port. The DeviceMaster Serial Hub does not support this command.                                                                                                                                                                                                                                                                                                                                                                                                                                                                              |
| <b>mac</b> †                                                                                                  | Displays ethernet MAC address.                                                                                                                                                                                                                                                                                                                                                                                                                                                                                                                                      |
| <b>model</b> †                                                                                                | Shows model number.                                                                                                                                                                                                                                                                                                                                                                                                                                                                                                                                                 |
| <b>password</b> {password}                                                                                    | Sets the password.                                                                                                                                                                                                                                                                                                                                                                                                                                                                                                                                                  |
| <b>reset</b>                                                                                                  | Resets the DeviceMaster UP.                                                                                                                                                                                                                                                                                                                                                                                                                                                                                                                                         |
| <b>telnet</b> [disable   enable]                                                                              | Sets or displays telnet server enable. Disables telnet.                                                                                                                                                                                                                                                                                                                                                                                                                                                                                                             |
| <b>teltimeout</b> [seconds]                                                                                   | Shows or sets telnet time-out.                                                                                                                                                                                                                                                                                                                                                                                                                                                                                                                                      |
| <b>terse</b>                                                                                                  | Terse command response mode.                                                                                                                                                                                                                                                                                                                                                                                                                                                                                                                                        |
| <b>timeout</b> {seconds}                                                                                      | Displays or sets Bootloader time-out value.                                                                                                                                                                                                                                                                                                                                                                                                                                                                                                                         |
| <b>t485 port #1 port #2</b>                                                                                   | Runs port-to-port RS-485 test.                                                                                                                                                                                                                                                                                                                                                                                                                                                                                                                                      |
| <b>version</b>                                                                                                | Displays RedBoot version information.                                                                                                                                                                                                                                                                                                                                                                                                                                                                                                                               |
| † Do not use these commands to change the values. Doing so may cause the DeviceMaster UP to stop functioning. |                                                                                                                                                                                                                                                                                                                                                                                                                                                                                                                                                                     |





# Troubleshooting and Technical Support

This section contains troubleshooting information for your DeviceMaster UP. You should review the following subsections before calling Technical Support because they will request that you perform many of the procedures or verifications before they will be able to help you diagnose a problem.

- [Troubleshooting Checklist on Page 57](#)
- [General Troubleshooting on Page 58](#)
- [Daisy-Chaining DeviceMaster UP 2E/4-Port Units on Page 59](#)

If you cannot diagnose the problem, you can contact [Technical Support on Page 60](#).

## Troubleshooting Checklist

---

The following checklist may help you diagnose your problem:

- Verify that you are using the correct types of cables on the correct connectors and that all cables are connected securely.

**Note:** *Most customer problems reported to Control Technical Support are eventually traced to cabling or network problems.*

- Isolate the DeviceMaster UP from the network by connecting the device directly to a NIC in a host system.

| Model                                 | Connected to        | Ethernet Cable | Connector Name          |
|---------------------------------------|---------------------|----------------|-------------------------|
| 1-Port                                | Ethernet hub or NIC | Standard       | 10/100 ETHERNET         |
| 1-Port Embedded                       | Ethernet hub or NIC | Standard       | RJ45 port (not labeled) |
| 2-Port - 1E (All models)              | Ethernet hub or NIC | Standard       | 10/100                  |
| 2-Port - 2E (All dual Ethernet ports) | NIC or Ethernet hub | Standard       | 10/100 - E1/E2          |
| 4-Port                                | NIC                 | Standard       | DOWN                    |
|                                       | Ethernet hub        | Standard       | UP                      |

- Verify that the Ethernet hub and any other network devices between the system and the DeviceMaster UP are powered up and operating.
- Reset the power on the DeviceMaster UP and watch the **PWR** or **Status** light activity.

| PWR or Status LED                                   | Description                             |
|-----------------------------------------------------|-----------------------------------------|
| 5 sec. off, 3 flashes, 5 sec. off, 3 flashes ...    | Redboot™ checksum failure.              |
| 5 sec. off, 4 flashes, 5 sec. off, 4 flashes ...    | SREC load failure.                      |
| 5 quick flashes                                     | The default application is starting up. |
| 10 sec. on, .1 sec. off, 10 sec. on .1 sec. off ... | The default application is running.     |

- If the device has a power switch, turn the device's power switch off and on, while watching the LED diagnostics.

- If the DeviceMaster UP does not have a power switch, disconnect and reconnect the power cord.
- Verify that the network IP address, subnet mask, and gateway is correct and appropriate for the network. If IP addressing is being used, the system should be able to ping the DeviceMaster UP.
- Verify that the IP address programmed into the DeviceMaster UP matches the unique reserved IP configured address assigned by the system administrator.
- If using DHCP, the host system needs to provide the subnet mask and gateway.
- Reboot the system and the DeviceMaster UP.
- If you have a spare DeviceMaster UP, try replacing the device.

## General Troubleshooting

---

This table illustrates some general troubleshooting tips.

**Note:** Make sure that you have reviewed the [Troubleshooting Checklist on Page 57](#).

| General Condition                                                                        | Explanation/Action                                                                                                                                                                                                                                                                                                                                                           |
|------------------------------------------------------------------------------------------|------------------------------------------------------------------------------------------------------------------------------------------------------------------------------------------------------------------------------------------------------------------------------------------------------------------------------------------------------------------------------|
| PWR or Status LED flashing                                                               | Indicates that boot program has not downloaded to the unit.<br>1. Reboot the system.<br>2. Make sure that you have downloaded the most current firmware for your protocol:<br><a href="http://www.comtrol.com/support/download.asp">http://www.comtrol.com/support/download.asp</a> .<br><b>Note:</b> If the PWR or Status LED is still flashing, contact Technical Support. |
| PWR or Status LED not lit                                                                | Indicates that power has not been applied or there is a hardware failure. Contact Technical Support.                                                                                                                                                                                                                                                                         |
| Cannot ping the device through Ethernet hub                                              | Isolate the DeviceMaster UP from the network. Connect the device directly to the NIC in the host system (see Page 57).                                                                                                                                                                                                                                                       |
| Cannot ping or connect to the DeviceMaster UP                                            | The default IP address is often not accessible due to the subnet masking from another network unless <b>192.168</b> is used in the network.<br><br>In most cases, it will be necessary to program in an address that conforms to your network.                                                                                                                               |
| DeviceMaster UP continuously reboots when connected to some Ethernet switches or routers | Invalid IP information may also cause the switch or router to check for a gateway address. Lack of a gateway address is a common cause.                                                                                                                                                                                                                                      |

---

## Daisy-Chaining DeviceMaster UP 2E/4-Port Units

---

The DeviceMaster UP 2E/4-port models with external power supplies follow the IEEE specifications for standard Ethernet topologies.

When using the **UP** and **DOWN** ports, the DeviceMaster UP 2E/4 is classified as a switch. When using the **UP** port only, it is a simple end node device.

The maximum number of daisy-chained DeviceMaster UP 2E/4 units, and the maximum distance between units is based on the Ethernet standards and will be determined by your own environment and the conformity of your network to these standards.

Control has tested with seven DeviceMaster UP 2E/4 units daisy-chained together using 10 foot CAT5 cables, but this is not the theoretical limit. You may experience a performance hit on the devices at the end of the chain, so it is recommended that you overload and test for performance in your environment. The OS and the application may also limit the total number of ports that may be installed.

Following are some quick guidelines and URLs of additional information. Please note that standards and URLs do change.

- Ethernet 10BASE-T Rules
  - The maximum number of repeater hops is four.
  - You can use Category 3 or 5 twisted-pair 10BASE-T cables.
  - The maximum length of each cable is 100m (328ft).

***Note:** Category 3 or 5 twisted pair cables look the same as telephone cables but they are not the same. The network will not work if telephone cables are used to connect the equipment.*
- Fast Ethernet 100BASE-TX rules
  - The maximum number of repeater hops is two (for a Class II hub). A Class II hub can be connected directly to one other Class II Fast Ethernet hub. A Class I hub cannot be connected directly to another Fast Ethernet hub.
  - You must use Category 5 twisted-pair 100BASE-TX cables.
  - The maximum length of each twisted-pair cable is 100m (328ft).
  - The total length of twisted-pair cabling (across directly connected hubs) must not exceed 205m (672ft).

***Note:** Category 5 twisted pair cables look the same as telephone cables but they are not the same. The network will not work if telephone cables are used to connect the equipment.*
- IEEE 802.3 specification: A network using repeaters between communicating stations (PCs) is subject to the “5-4-3” rule of repeater placement on the network:
  - Five segments connected on the network.
  - Four repeaters.
  - Three segments of the 5 segments can have stations connected. The other two segments must be inter-repeater link segments with no stations connected.

See <http://www.optronics.gr/Tutorials/ethernet.htm> for more specific information.

Additional information may be found at <http://compnetworking.about.com/cs/ethernet1/> or by searching the web.

## Technical Support

---

---

It contains troubleshooting procedures that you should perform before contacting Technical Support since they will request that you perform, some or all of the procedures before they will be able to help you diagnose your problem. If you need technical support, use one of the following methods.

| <b>Control Contact Information</b> |                                                                                 |
|------------------------------------|---------------------------------------------------------------------------------|
| Downloads                          | <a href="http://www.comtrol.com/downloads">http://www.comtrol.com/downloads</a> |
| Web site                           | <a href="http://www.comtrol.com">http://www.comtrol.com</a>                     |
| Phone                              | (763) 494-4100                                                                  |

# Index

## Numerics

### 100 LED

4-port [20](#)

### 4-port

installation [20](#)

## A

### add

new DeviceMaster [21](#)

### agency

notices [45](#)

## B

### baud rate/port [39](#)

### boot cycle

1-port

embedded [15](#)

enclosed [11](#)

2-port

DB9 [19](#)

serial terminal [17](#)

4-port [20](#)

8-port [20](#)

### Bootloader

downloading latest [6](#), [7](#), [8](#)

version

Redboot [50](#)

### building

embedded serial ribbon cable [12](#)

### building cables

see cables

## C

### cables

embedded ribbon cable [12](#)

null-modem

DB9 [30](#)

RJ45 [31](#)

serial terminals (8) [36](#)

RS-485 test [32](#)

straight-through

DB9 [30](#)

RJ45 [32](#)

serial terminal (4) [34](#)

serial terminals (8) [37](#)

### changing

IP address [24](#)

network settings [24](#)

### COL LED

4-port [20](#)

### commands

#!DM [47](#)

### configuration

DeviceMaster [23](#)

network

Redboot [49](#)

network settings [24](#)

overview [5](#)

serial method [47](#)

telnet [48](#)

uploading firmware [26](#)

using Redboot [47](#)

### connect

devices [29](#)

### contact information [60](#)

## D

### daisy-chaining devices

2-port 2E

DB9 [19](#)

serial terminal [16](#)

4-port [20](#)

8-port [20](#)

guidelines [59](#)

### data bits [39](#)

### DB9

loopback plugs [31](#)

null-modem cables [30](#)

straight-through cables [30](#)

### default

network settings [9](#), [24](#)

network values [39](#)

### DeviceMaster

adding units [21](#)

configuration [23](#)

configure network [47](#)

configuring network settings [24](#)

replacing hardware [21](#)

resetting

Redboot [50](#)

### devices

how to connect [29](#)

how to daisy-chain

2-port 2E model

DB9 [19](#)

serial terminal [16](#)

4-port models [20](#)

### DHCP IP

PortVision Plus [24](#)

### disable

loading

Redboot [55](#)

### disable DeviceMaster

#!DM command [47](#)

**Disable IP**

PortVision Plus [24](#)

**display**

Bootloader timeout [55](#)

IP address [55](#)

MAC address [55](#)

model number [55](#)

Redboot version [55](#)

telnet [55](#)

**documentation**

EtherNet/IP [6](#)

Modbus/TCP [7](#)

PROFINET CbA [7](#)

PROFINET IO [8](#)

**DOWN port**

4-port [20](#)

8-port [20](#)

**downloading**

latest software and documentation [6](#)

**downloads**

web site [60](#)

**E****embedded**

installation [12](#)

**EtherNet/IP**

documentation [6](#)

downloading latest [6](#)

uploading firmware [26](#)

**E****firmware**

EtherNet/IP [6](#)

Modbus/TCP [7](#)

PROFINET CbA [7](#)

PROFINET IO [8](#)

uploading [26](#)

**flow control** [39](#)**G****gateway address**

default [9, 24](#)

**getting started** [5](#)**H****hardware**

configuring network settings [24](#)

descriptions [9](#)

installation [9](#)

replace [21](#)

uploading firmware [26](#)

**help command**

Redboot [55](#)

**I****installation**

1-port

embedded [12](#)

enclosed [10](#)

2-port

DB9 [18](#)

serial terminal [16](#)

4-port [20](#)

add new device [21](#)

configuration [23](#)

configuring network settings [24](#)

hardware [9](#)

overview [5](#)

PortVision Plus [23](#)

uploading firmware [26](#)

**interface standards** [39](#)**IP address**

changing network settings [24](#)

configuration

Redboot [49](#)

default [9, 24, 39, 49](#)

how to determine

Redboot [49](#)

**ip command** [55](#)**IP gateway**

changing network settings [24](#)

default [39, 49](#)

**L****LEDs**

1-port

embedded [15](#)

enclosed [11](#)

2-port [17, 19](#)

4-port [20](#)

analysis [57](#)

**LNK ACT LED**

4-port [20](#)

**load**

TFTP or Xmodem [55](#)

**load command** [55](#)**loopback plugs**

DB9 [31](#)

RJ45 [32](#)

serial terminal (4) [35](#)

serial terminal (8) [38](#)

**M****mac command** [55](#)**Modbus/TCP**

documentation [7](#)

downloading latest [7](#)

uploading firmware [26](#)

**model command** [55](#)

**N****network**

- configuration
  - telnet [49](#)
- configuring settings [24](#)
- default values [39](#)
- how to connect to [9](#)
- protocols [39](#)

**network information**

- how to determine
  - RedBoot [49](#)

**null-modem cables** [30](#)

- DB9 [30](#)
- RJ45 [31](#) [32](#)
- serial terminals (8) [36](#)

**O****overview**

- installation steps [5](#)

**P****parity** [39](#)**password**

- administrator
  - Redboot [55](#)

**password command** [55](#)**phone**

- Technical Support [60](#)

**PortVision Plus**

- changing network settings [24](#)
- configuring network settings [24](#)
- download latest [6](#)
- installation [23](#)
- uploading firmware [26](#)

**power supply**

- specification
  - 1-port (5-30VDC) [40](#)
  - 2-port
    - DB9 [40](#)
    - serial terminal [40](#)
  - 4-port [41](#)

**PROFINET CbA**

- documentation [7](#)
- downloading latest [7](#)
- uploading firmware [26](#)

**PROFINET IO**

- documentation [8](#)
- downloading latest [8](#)
- uploading firmware [26](#)

**PWR**

- LED
  - 4-port [20](#)
  - 8-port [20](#)
  - analysis [57](#)

**PWR LED**

- 4-port [20](#)

**R****Redboot**

- administrator password [55](#)
- command overview [55](#)
- configure IP [49](#)
- LED activity [57](#)
- using for configuration [47](#)

**replace**

- hardware [21](#)

**reset**

- DeviceMaster
  - Redboot [50](#)

**reset command** [55](#)**ribbon cable**

- embedded [12](#)

**RJ45**

- loopback plugs [32](#)
- null-modem cables [31](#) [32](#)
- straight-through cables [32](#)

**RS-485**

- test cable [32](#)

**S****safety**

- information [45](#)

**screw terminals**

- see serial terminals

**serial**

- connector types [39](#)
- embedded ribbon cable [12](#)

**serial method**

- configuration [47](#)
- updating firmware [51](#)

**serial terminals (4)**

- loopback plugs [35](#)
- signals [33](#)
- straight-through cables [34](#)

**serial terminals (8)**

- loopback plugs [38](#)
- null-modem cables [36](#)
- signals [36](#)
- straight-through cables [37](#)

**set**

- Bootloader timeout [55](#)
- IP address [55](#)
- password [55](#)
- telnet [55](#)

**signals**

- serial terminals (4) [33](#)
- serial terminals (8) [36](#)

**SNMP support** [39](#)**SocketServer**

- downloading latest [6](#) [7](#) [8](#)

**software**

- downloading latest [6](#)

**software control**

- specifications [39](#)

**specifications**

- power supply
  - 1-port (5-30VDC) [40](#)
  - 2-port
    - DB9 [40](#)
    - serial terminal [40](#)
  - 4-port [41](#)

**Static IP**

- PortVision Plus [24](#)

**Status LED**

- 1-port
  - embedded [15](#)
  - enclosed [11](#)
- 2-port
  - DB9 [19](#)
  - serial terminal [17](#)
- analysis [57](#)

**stop bits [39](#)**

**straight-through cables**

- DB9 [30](#)
- RJ45 [32](#)
- serial terminal (4) [34](#)
- serial terminals (8) [37](#)

**subnet mask**

- default [9](#), [24](#), [39](#), [49](#)

**I**

**Technical Support [57](#), [60](#)**

**telnet command [55](#)**

**telnet method**

- configuration [48](#)
- updating firmware [52](#)

**terminal**

- loopback signals (4) [35](#)
- loopback signals (8) [38](#)
- serial signals (4) [33](#)
- serial signals (8) [36](#)

**TFTP**

- load command [55](#)

**timeout command [55](#)**

**troubleshooting [57](#)**

**U**

**UP port**

- 4-port [20](#)
- 8-port [20](#)

**upgrading**

- PortVision Plus [23](#)

**uploading**

- firmware [26](#)

**V**

**version**

- Bootloader
  - Redboot [50](#)

**version command [55](#)**

**W**

**web site [60](#)**

**X**

**Xmodem**

- load command [55](#)