

5500 Programming Quick Guide

Operating Elements of the Controller

The 5500 controller has four pushbuttons and five LEDs.



To advance up



To advance down



For EXIT out of parameter and RESET



Enter purge settings and select function

If the button is pressed longer than 5 seconds, the 5500 controller will go into the programming mode. The entries appear in the following sequence:

DISPLAY	PARAMETER	DEFAULT
PASSWORD / SET	Enter PSW settings	0000
PURGE / PROGRAM	Program modes	3
PURGE / TIME	Purging time	00:30
ENCLOSUR/PRESS P1	Min pressure	Gas: 0.3" (0.8mbar) Dust: 0.7" (1.8mbar)
ENCLOSUR/PRESS P2	Alarm pressure	0.8" (2 mbar)
ENCLOSUR/PRESS P3	Purging pressure	3.0" (7.5 mbar)
ENCLOSUR/PRESS P4	Max pressure	6.0" (15 mbar)
LEAKAGE / HYST	Leakage comp	0.5" (1.25 mbar)
PROGRAM / K2	K2 function	K1
SHUT-OFF / DELAY	Delay shut-off K1	0 sec
NUMBER / OF Pt100	2 max for Pt100	0
TEMP PT1 / SV1	SV1 on above PT1	35 °C
TEMP PT2 / SV1	SV1 on above PT2	35 °C
TEMP PT1 / K2	K2 on above PT1	45 °C
TEMP PT2 / K2	K2 on above PT2	45 °C
TEMP PT1 / K1	K1 on above PT1	50 °C
TEMP PT2 / K1	K1 on above Pt2	50 °C
BYPASS / N Y E	Bypass off/on/External	N
UNITS / M I	Metric or Imperial	I
TEMP / ENABLED	Temp function enable	N
CHANGE / PASSWORD	Change password	-----

Program	Application	Purge	Operation Specifics
Purge 1	Gas	Immediate Purge	<ul style="list-style-type: none"> Purge starts on power up (SV1) After purging Enclosure contacts (K1) energize If max. Press (P4) is reached, SV1 turns off Enclosure power ON during loss of pressure (K1) Alarms can be set for low pressure/temp. (K2) Pressure compensation turns on below (P2)
Purge 2	Gas	Delayed Purge	<ul style="list-style-type: none"> Purge starts above P1 pressure (SV1) After purging Enclosure contacts (K1) energize If max. Press (P4) is reached, Sv1 turns off Enclosure power on during loss of pressure (K1) Alarms can be set for low pressure/temp. (K2) Pressure compensation turns on below (P2)
Purge 3	Gas	Delayed Purge	<ul style="list-style-type: none"> Purge starts above P1 pressure (SV1) After purging, enclosure contacts (K1) energize If max. Press (P4) is reached, SV1 turns off Immediate shut-down during loss of pressure (K1) Alarms can be set for low pressure/temp. (K2) Pressure compensation turns on below (P2)
Purge 4	Gas	Immediate Purge	<ul style="list-style-type: none"> Purge starts on power up (SV1) After purging, enclosure contacts (K1) energize If max. Press (P4) is reached, SV1 turns off Enclosure power on during loss of pressure (K1) Alarms can be set for low pressure/temp. (K2) Pressure compensation turns on below (P3) Intended for continuous purge applications
Purge 5	Dust	Clean Enclosure	<ul style="list-style-type: none"> In dust atmosphere purging is not required Enclosure must be cleaned Pressure above (P1), Enclosure contact on (K1) Enclosure power ON during loss of pressure (K1) Alarms can be set for low pressure/temp. (K2) Pressure compensation turns on below (P2)

MENU STRUCTURE

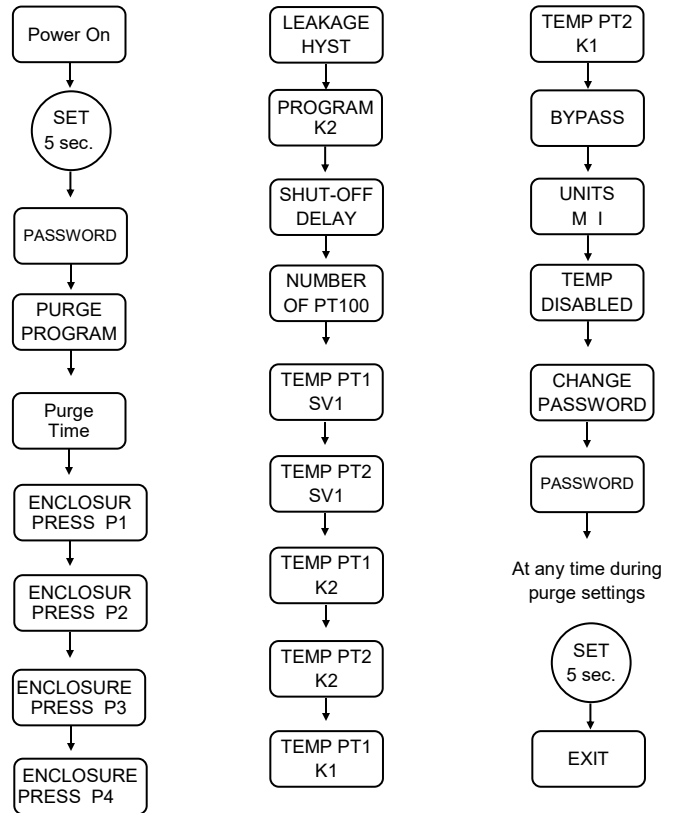

LED Indication



LED	LED Color	Description
K1	Green	Contact K1 is energized
K2	Amber	Contact K2 is energized
P/SV1	Blue Amber	Safe pressure P1 SV1 is energized
BYPASS	Amber	Bypass ON
PT100	Red	Pt100 fault

Purge time

Purge time is set in Min:Sec (000:00). Hold either key down to adjust the set time more quickly.

ENCLOSURE / PRESS P1

Pressure P1 is the minimum allowed pressure for safe use. Minimum value is 0.3" for gas and 0.7" for dust.

ENCLOSURE / PRESS P2

Pressure P2 is used for low pressure function. Compensation for leakages for certain functions will activate SV1 when below P2.

ENCLOSURE / PRESS P3

Pressure P3 is used to activate the time for purging. Pressure above P3 indicates proper flow for purging. In Program 4, P3 will start continuous flow compensation.

ENCLOSURE / PRESS P4

Pressure P4 is a maximum overpressure value. In reaching this value, the display will read 'MAX'. If P4 is achieved during purging, SV1 will shut off until pressure is below P4.

5500 Programming Quick Guide

LEAKAGE / HYST

Unexpected leakages from the enclosure or line pressure drops will decrease the pressure within the enclosure. If the pressure drops below P2 or P3 (Program 4), then the valve SV1 can be activated until P2 (P3) + Hyst is reached and will shut off. Compensating for leakages.

PROGRAM / K2

Relay output K2 can be programmed for several functions. These functions are as follows:

K1	Switch with K1
P1+	Switch on, if P1 exceeded
P1-	Switch off, if P1 below
P2+	Switch on, if P2 exceeded
P2-	Switch off, if P2 below
P3+	Switch on, if P3 exceeded
P4-	Switch on, if P4 below
P4+	Switch off, if P4 exceeded
FT	Switch on during purging
TEMP AL	Switch on if temp is exceeded
Bypass	Switch on if bypass is active

SHUT-OFF / DELAY

During operation of Program 3, if the pressure drops below P1, the delay of shutting down K1 can be implemented. The delay is selectable and can be set to durations between 0 to 60 seconds.



The use of the delay timer is the sole responsibility of the user.

NUMBER / OF PT100

The 5500 has 2 inputs for 2-wire PT100 temperature sensors which can be placed within the enclosure for monitoring various areas. For temperature monitoring or control TEMP /ENABLED function must be selected.

TEMP PT1 / SV1

TEMP PT2 / SV1

Each 2-wire PT100 sensor can be set to a max. temperature. When one of the set temperatures are reached, the SV1 will activate and cool the cabinet. When the temperature drops by 3°C, the valve will close.

TEMP PT1 / K2

TEMP PT2 / K2

Each 2-wire PT100 sensor can be set to a max. temperature. When one of the set temperatures are reached, the K2 will activate which can be used to activate a cooling device or an alarm. When the temperature drops by 3°C, K2 deactivates.

TEMP PT1 / K1

TEMP PT2 / K1

Each 2-wire PT100 sensor can be set to a max. temperature. When one of the set temperatures are reached, the K1 will de-activate. A reset of the system will have to be initiated which will start the purging mode.

BYPASS / N Y E

Allows K1 to energize/stay energized when pressure below P1. External switch allows K1 to energize after the purging cycle is complete and pressure is above P1. 'Y' will turn bypass on before purge and immediately energize K1.

UNITS / M I

Allows for metric (M) or Imperial (I) values. Temperature will always be in Celsius.

TEMP / ENABLED

Enables the temperature function. If settings are incorrect, PT100 LED will light up.

CHANGE / PASSWORD

Enter at least 4 digits. To exit without saving password, press RESET. To accept password, press SET.

Electrical Connections

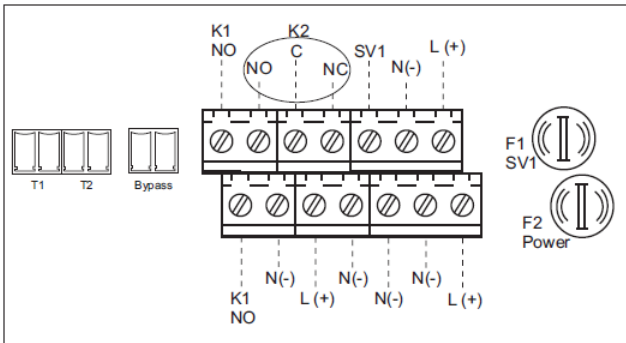

External Mount Terminal Block

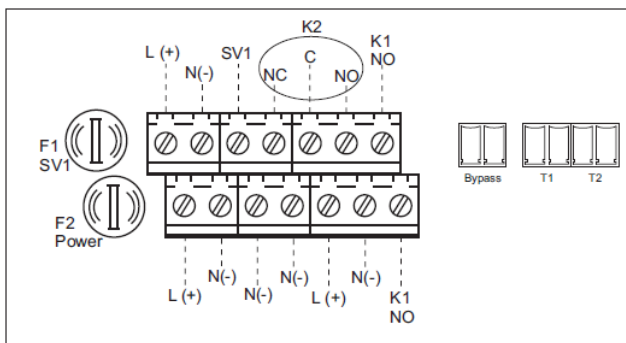

Internal Mount Terminal Block

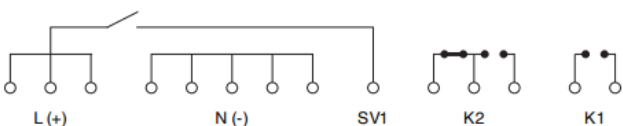

Troubleshooting

Fault	Possible Reason	Reaction
5500 doesn't work	No voltage	Check power cables to 5500
	5500 defect	Return 5500
5500 switches on without purge	Purging program is wrong	Verify correct purge program
Purge timer does not count down	No purge gas	Check gas supply
	Digital valve does not open	Check voltage
		Check for blockage
	Not enough flow from digital valve	Line pressure to low
		Tubing to valve is to small
	Not enough flow to regulator	Line pressure to low
Tubing to valve is to small		
To much leakage from enclosure		
Purging process does not begin	Digital valve does not open	Check power to valve
	Digital valve does not open	Check for blockage
		Gas supply is not clean
High temperature inside enclosure	Ambient temp. rise	Check location of enclosure to environment
Digital valve shuts off before purging complete	Too much leakage from the enclosure and pressure is dropping below P1	Check enclosure seals; increase flow from needle valve
	Pressure exceeds P4	Ensure that vent flow is not restricted; reduce purge flow

5500 Programming Quick Guide

Calculation of the Purging Time

Example:

Vent: EPV-5500-___-02 (From manual graph)
P3 set to : 2.6" H₂O (6.5mbar)

Enclosure volume: 10 cu.ft. (282 liters) Not a motor
Flow rate from vent graph: 11.3 scfm (320 liters/min)
requirement for purging

- NEC: 4 volume exchanges
- IEC: 5 volume exchanges

Results:

- NEC: $4 \times 10 \text{ cu.ft.} / 11.3 \text{ scfm} = 3.6 \text{ min.}$
($4 \times 282 \text{ liters} / 320 \text{ l/min} = 3.6 \text{ min.}$)
- IEC: $5 \times 10 \text{ cu.ft.} / 11.3 \text{ scfm} = 4.5 \text{ min.}$
($5 \times 282 \text{ liters} / 320 \text{ l/min} = 4.5 \text{ min.}$)

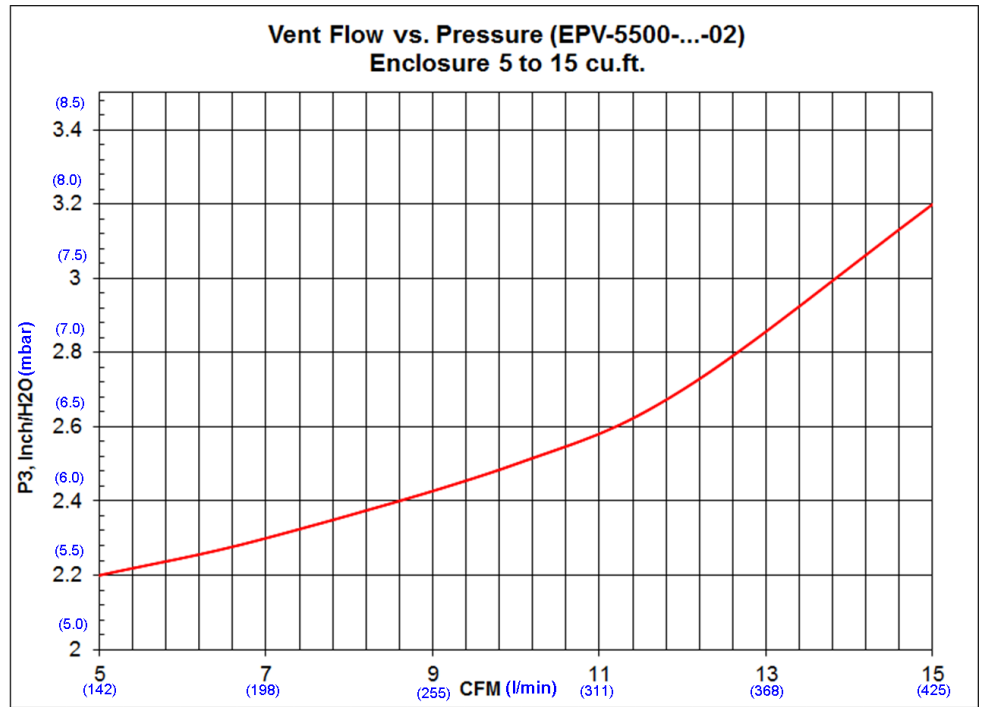

From installation manual for 5500 vent graphs
EPV-5500-...-02, enclosure volume 5 to 15 cu.ft.

Typical Installation Setup

Typical installation and the identification of components, and location in the enclosure

The 5500 control unit is mounted on the side of the enclosure but could easily be mounted on the top, or bottom. The EPV-5500 vent is mounted inside the enclosure but could also be mounted outside the enclosure if room prohibits it. The EPV-5500 vent should always be mounted so that the flow coming into the enclosure does not go directly through the vent. Adjacent corners are best for complete flushing out the enclosure. The manifold or valve system (not shown) can be mounted outside or inside the enclosure. If the 5500-MAN's are used, mounting hardware is included

The 5500 control unit can be mounted inside the enclosure. The EPV-5500 vent is mounted inside the enclosure but could also be mounted outside the enclosure if room prohibits it. The EPV-5500 vent should always be mounted so that the flow coming into the enclosure does not go directly through the vent. Adjacent corners are best for complete flushing out the enclosure. The manifold or valve system (not shown) can be mounted outside or inside the enclosure. If the 5500-MAN's are used, mounting hardware is included.

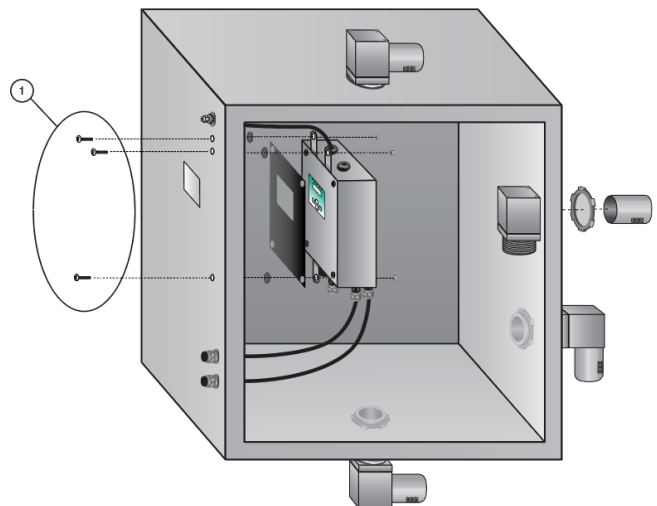
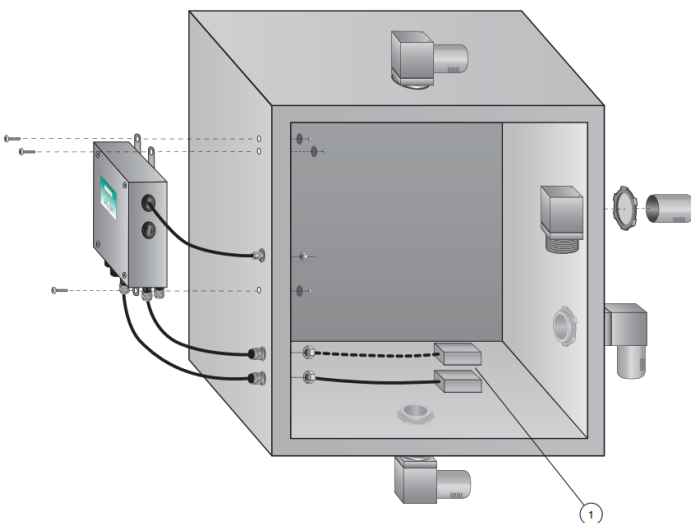

- 1) RTDs - not included.
- 2) Pressure reference kit included. Required to measure ambient pressure outside for the differential pressure sensor within the 5500 control unit. Tubing kit connected to port labeled 'Enclosure Pressure'.
- 3) Key pad must be mounted in a vertical orientation only.



- 1) Internal studs may be added to enclosure for cleaner looking installation.
- 2) Pressure reference kit included. Required to measure ambient pressure outside for the differential pressure sensor within the 5500 control unit. Tubing kit connected to port labeled 'Atmospheric Pressure'.
- 3) Key pad must be mounted in a vertical orientation only.