

# Segment Coupler 1

## KFD2-BR-Ex1.3PA.93

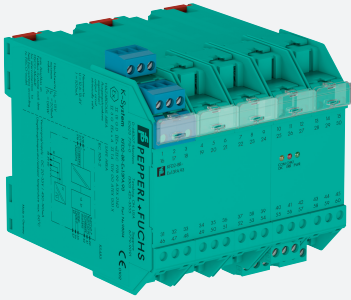

- Output: 12.6 ... 13.4 V/100 mA
- Couples PROFIBUS PA devices transparently to PROFIBUS DP
- Intrinsically safe, Ex ia (FISCO or Entity)
- Installation in Zone 2/Class I, Div. 2
- Fixed, high-availability terminator
- For all non-redundant masters
- Cyclic/acyclic data exchange



### Function

The Segment Coupler 1 (SK1) is an all-in-one gateway and fieldbus power supply for connecting PROFIBUS PA to PROFIBUS DP transparently. The Segment Coupler powers a single PROFIBUS PA segment adapting current and voltage. The output is rated intrinsically safe Ex ia IIC according to FISCO and Entity. The complete segment can be installed intrinsically safe. Communication is transparent between DP and PA. The gateway of the Segment Coupler makes each PA device appear as if it was connected to DP: This relates to addressing, cyclic/acyclic data exchange, and the transfer rate. Segment design is clear and easy to understand without subnetworks. The gateway itself is configuration-free. All in all, these features significantly reduce engineering work. SK1 supports any PROFIBUS DP master at a fixed transfer rate of 93.75 kbps.

### Connection

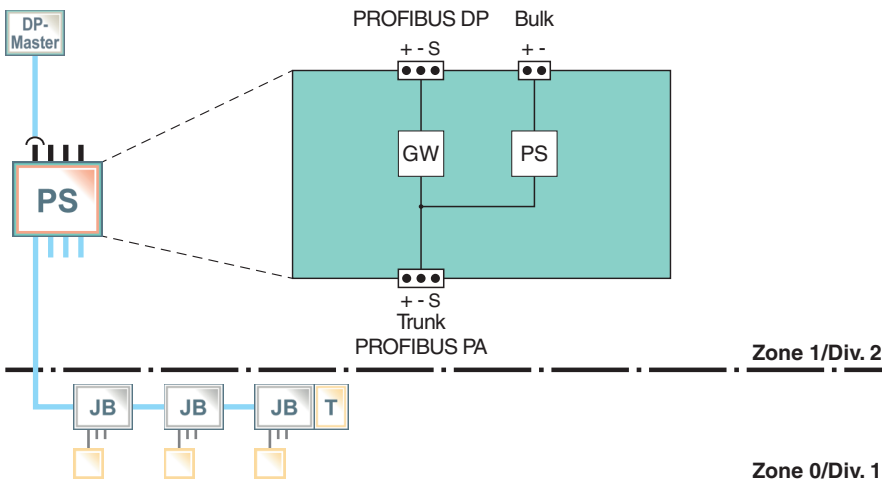

### Technical Data

#### General specifications

Design / Mounting Cabinet installation

#### Supply

Connection Power Rail or terminals 59+, 60-, 58 FE

Rated voltage  $U_r$  20 ... 35 V DC

Ripple  $\leq 10$  %

Rated current  $I_r$  190 mA ... 430 mA

#### Fieldbus connection

PROFIBUS PA  
Connection terminals 3, 18+; 2, 17-

Release date: 2022-07-04 Date of issue: 2022-07-04 Filename: 098314\_eng.pdf

Refer to "General Notes Relating to Pepperl+Fuchs Product Information".

Pepperl+Fuchs Group  
www.pepperl-fuchs.com

USA: +1 330 486 0002  
pa-info@us.pepperl-fuchs.com

Germany: +49 621 776 2222  
pa-info@de.pepperl-fuchs.com

Singapore: +65 6779 9091  
pa-info@sg.pepperl-fuchs.com

**pf** PEPPERL+FUCHS

## Technical Data

Rated voltage		12.6 ... 13.4 V
Rated current		max. 100 mA
Terminating impedance		100 Ω , integrated
PROFIBUS DP		PROFIBUS with RS-485 transmission technology
Connection		Terminals 40 RxD/TxD-P, 41 RxD/TxD-N, 42 screen/FE, 55 DGND, 56 CNTR-P, 57 VP
Baud rate		93.75 kBit/s
Terminating impedance		with rotary switch (S1) switchable: 1 = on; 0 = off
<b>Galvanic isolation</b>		
PROFIBUS DP/PROFIBUS PA		safe galvanic isolation acc. to EN 50020, voltage peak value 375 V
PROFIBUS DP/Supply		functional insulation acc. to DIN EN 50178, rated insulation voltage 50 V <sub>eff</sub>
PROFIBUS PA/Supply		safe galvanic isolation acc. to EN 50020, voltage peak value 375 V
<b>Directive conformity</b>		
Electromagnetic compatibility		
Directive 2014/30/EU		EN 61326-1:2013
<b>Standard conformity</b>		
Galvanic isolation		EN 50178
Electromagnetic compatibility		NE 21:2006
Degree of protection		IEC 60529
Fieldbus standard		EN 50170/2
Climatic conditions		IEC 60721
<b>Ambient conditions</b>		
Classification		3K3
Ambient temperature		-20 ... 60 °C (-4 ... 140 °F)
Storage temperature		-40 ... 85 °C (-40 ... 185 °F)
Relative humidity		< 75 %
Pollution degree		max. 2, according to IEC 60664
<b>Mechanical specifications</b>		
Connection type		Terminals
Core cross section		up to 2.5 mm <sup>2</sup>
Housing		100 mm x 115 mm x 107 mm
Degree of protection		IP20
Mass		650 g
Mounting		DIN rail mounting
<b>Data for application in connection with hazardous areas</b>		
EU-type examination certificate		PTB 99 ATEX 2142 , for additional certificates see <a href="http://www.pepperl-fuchs.com">www.pepperl-fuchs.com</a>
Marking		Ⓜ II (1) G [Ex ia] IIC Ga , Ⓜ II (1) D [Ex ia] IIIC Da
Supply		
Maximum safe voltage	U <sub>m</sub>	253 V AC / 125 V DC (Attention! U <sub>m</sub> is no rated voltage.)
<b>PROFIBUS PA</b>		
Voltage	U <sub>o</sub>	15 V
Current	I <sub>o</sub>	207.2 mA
Power	P <sub>o</sub>	1.93 W
Maximum safe voltage	U <sub>m</sub>	60 V
Certificate		PF 15 CERT 3527 X
Marking		Ⓜ II 3G Ex ec II T4 Gc
<b>Directive conformity</b>		
Directive 2014/34/EU		EN 60079-0:2012 , EN 60079-7:2015 , EN 60079-11:2012
<b>General information</b>		
Supplementary information		EC-Type Examination Certificate, Statement of Conformity, Declaration of Conformity, Attestation of Conformity and instructions have to be observed where applicable. For information see <a href="http://www.pepperl-fuchs.com">www.pepperl-fuchs.com</a> .

Release date: 2022-07-04 Date of issue: 2022-07-04 Filename: 098314\_eng.pdf

Refer to "General Notes Relating to Pepperl+Fuchs Product Information".

Pepperl+Fuchs Group  
[www.pepperl-fuchs.com](http://www.pepperl-fuchs.com)USA: +1 330 486 0002  
pa-info@us.pepperl-fuchs.comGermany: +49 621 776 2222  
pa-info@de.pepperl-fuchs.comSingapore: +65 6779 9091  
pa-info@sg.pepperl-fuchs.com

**PEPPERL+FUCHS**

## Assembly

## Accessories

	<b>KFD2-EB2</b>	Power Feed Module
---	-----------------	-------------------

Release date: 2022-07-04 Date of issue: 2022-07-04 Filename: 098314\_eng.pdf

Refer to "General Notes Relating to Pepperl+Fuchs Product Information".

Pepperl+Fuchs Group  
www.pepperl-fuchs.com

USA: +1 330 486 0002  
pa-info@us.pepperl-fuchs.com

Germany: +49 621 776 2222  
pa-info@de.pepperl-fuchs.com

Singapore: +65 6779 9091  
pa-info@sg.pepperl-fuchs.com

## Additional Information

### Dimensions

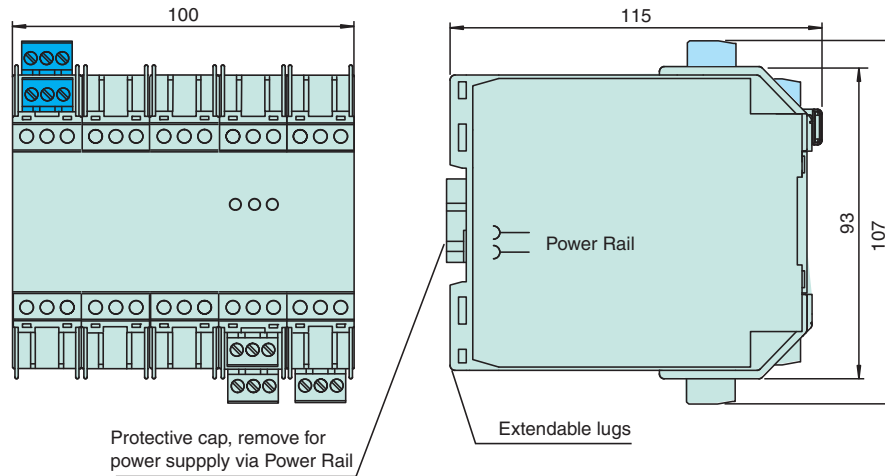

### Accessories

Power Rail	UPR-03	Inset component for DIN rail in accordance with DIN EN 50022, standard length 500 mm
Power supply modules	KFD2-EB2	Supplies power to the power rail at a voltage of 24 V DC and a max. current of 4 A
Terminator	KMD0-FT-Ex F*-FT-Ex1.I.IEC F*-FT-Ex1.D.IEC	Terminates the PROFIBUS PA branch in the field. The KMD0-FT-Ex is connected to the last PROFIBUS PA station.

### Installation

#### Connection

##### Please note!

On the segment coupler no supply voltage or other external voltage must be applied to the PROFIBUS terminals.  
For additional information see the PNO manual for PROFIBUS PA.

#### Output characteristic

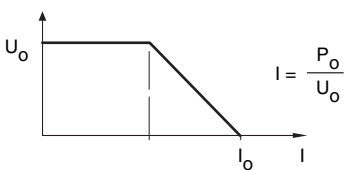

#### \*) FISCO:

Fieldbus Intrinsically Safe Concept

#### Number of stations, current consumption of stations:

The total of the max. current consumption of connected bus stations must be less than the rated current  $I_S$  of the segment coupler.  
The modulation current with which a bus station sends data does not need to be taken into consideration.

#### Ground, shield:

For reasons of interference immunity, the shield/FE, the FE and especially the shield/PA should be connected to a functional ground (or Ex-ground) on the segment coupler.

### Commissioning and Operation

#### Configuration

**Bus parameters:** Bus parameters of the PROFIBUS Master

Operation is ensured with the following bus parameters:

Parameter	Value	For description see section	Description
Baudrate (kBit/s)	93.75		
$T_{SL}$ (t <sub>Bit</sub> )	4095	Slot time	
min $T_{SDR}$ (t <sub>Bit</sub> )	22		Station delay time
$T_{ID2}$ (t <sub>Bit</sub> )	1000	Idle2 time	
max $T_{SDR}$ (t <sub>Bit</sub> )	1000	in Idle2 time	
$T_{ID1}$ (t <sub>Bit</sub> )	145/335 <sup>*)</sup>	Idle1 time	
$T_{SET}$ (t <sub>Bit</sub> )	55/150 <sup>*)</sup>	in Idle1 time	
$T_{QUI}$ (t <sub>Bit</sub> )	0		Quiet time
G	10		Gap factor
HSA	126	Highest Station Address	
max_retry_limit	1		Repetitions in event of failure

\*) There are no response errors for these values, even with older devices.

All time units that are specified in bits (without index <sup>1)</sup>) refer to 93.75 kBit/s. 1 Bit = 10.66 µs.

### Idle1 time:

The Idle1 time  $T_{ID1}$  is the idle time that must be observed by the Master between a response telegram and the following call-up telegram. The Idle time  $T_{ID1}$  should not be set directly by parameter for many control tools. To adjust the Idle time in spite of this, the Setup time parameter  $T_{SET}$  must be changed or, if  $T_{SET}$  is also inaccessible,  $T_{QUI}$  :

$T_{ID1}$  is calculated from:  $T_{ID1} = 2 \times T_{SET} + T_{QUI} + 35 \text{ Bit}$

The Idle time  $T_{ID1}$  depends on the maximum response time <sup>2)</sup> of all PA bus stations. For  $T_{ID1}$  and  $T_{SET}$ , values are specified in the left column corresponding to the current PROFIBUS regulations. Under certain circumstances, older PROFIBUS devices that do not work with the response times in accordance with Standard PROFIBUS DP-E could cause telegrams to be repeated. If this behaviour occurs, you can increase the Idle 1 time as an emergency measure. However, this also increases system response time (see Diagram 1).

### Slot time:

The Slot time  $T_{SL}$  should be set to 4 095<sup>3)</sup> Bit. The Slot time depends on the following parameters:

- Data field length  $L_S$  of the call-up telegram [byte]<sup>4)</sup>
- Data field length  $L_R$  of the response telegram [byte]
- Station delay time  $T_{SDR}$  of the PA bus station<sup>5)</sup> [Bit<sub>PA</sub>]<sup>6)</sup>

If the maximum total of data field length  $L_S$  and data field length  $L_R$  of all bus stations is known, the Slot time can be optimised (minimised):

$$T_{SL} > 13 \text{ Bit} \times (L_S + L_R) + 3 \text{ Bit} \times T_{SDR}/\text{Bit}_{PA} + 630 \text{ Bit [Bit]}$$

In contrast to the Idle1 time, the Slot time has only a minor effect on the system response time. Because of this, no minimisation is required. If the value of  $T_{SL}$  is too small, data exchange with long data field lengths cannot take place and the telegram packets will collide (see LED display, collision). For these reasons, the Slot time should not be set too low.

### Idle2 time:

The Idle2 time  $T_{ID2}$  is the idle time between an SDN (**S**end **D**ata with **n**o **A**cknowledge)<sup>7)</sup> and the subsequent call-up telegram. It should be set to 1000 Bit. If  $T_{ID2}$  will not be set directly, the parameter max.  $T_{SDR}$  is used. If max.  $T_{SDR}$  is greater than  $T_{ID1}$  (as in the table), the value of max.  $T_{SDR}$  is accepted for  $T_{ID2}$  <sup>8)</sup>.

### Highest Station Address HSA:

A PROFIBUS master queries the status of all stations cyclically up to the address value HSA. As soon as one station at an address lower than HSA does not respond, (for example because it is not connected) the relatively long Slot time expires. The effect on the system response time is illustrated in Diagram 1. If it is ensured that a station is present for each address up to and including HSA, this Slot time can be avoided --> Diagram 1, broken line.

**Comments for projecting, time response:**

Within the bus-specific communication interfaces, the time interval from the transfer of a piece of information to the next transfer of this information, or when it is updated, is referred to as the **system response time**, access time or total cycle time. The actual system response time is the total of all message cycles<sup>9)</sup> (the message cycle time) within a token cycle<sup>10)</sup>. Not all messages are processed cyclically (in every token cycle). These acyclic telegrams can be ignored at first, since they are used only sporadically. Starting with single-master operation, the system response time is the total of message cycles  $T_{MCi}$  to the passive bus stations. "n" is the number of these stations. A good approximation of the actual system response time  $T_{SYS}$  can be obtained by adding up one message cycle for effective data (cyclic data exchange) for each bus station "i" ( $i = \{1 \dots n\}$ ). In addition, the duration of the Gap Update and Token  $T_{G+T}$  are added.

$$T_{SYS} = \sum_{i=1}^n T_{MC(i)} + T_{G+T}$$

The value of  $T_{G+T}$  is a maximum (worst case) of 47 ms (boundary conditions<sup>11)</sup>). With a smaller number of stations, the duration of  $T_{T+G}$  is noticeable (see Diagram 1).  $T_{T+G}$  can be reduced to 11.36 ms (boundary conditions<sup>12)</sup>) by adjusting the Highest Station Address HSA --> Diagram 1, broken line. See Highest Station Address.

The duration of a message cycle depends on the effective data length  $L_S$  of the call (Output\_Length) and  $L_R$  of the response (Input\_Length). [in Bytes]

**Equation 1**

$$T_{MC} = 11 \text{ ms} + 0.256 \text{ ms} \times (L_S + L_R)$$

Boundary conditions<sup>13)</sup> --> Diagram 2 ( $T_{ID1} = 145 \text{ Bit}$ )

To enhance clarity, for the effective data lengths  $L_S$  and  $L_R$ , their sum  $L_{\Sigma}$  is used:  $L_{\Sigma} = L_S + L_R$

The response time  $T_{SYS}$  can be calculated by adding up the effective data lengths  $L_{\Sigma(i)}$  of stations  $i = \{1 \dots n\}$ .

**Equation 2**

$$T_{SYS} = n \times 11 \text{ ms} + 0.256 \text{ ms} \times \sum_{i=1}^n L_{\Sigma(i)} + 47 \text{ ms}$$

If an average effective data length  $\bar{L}_{\Sigma}$  is used, Equation 1 with n stations is simplified to:

**Equation 3**

$$T_{SYS} = n \times \bar{T}_{MC} + T_{G+T} = n \times (11 \text{ ms} + \bar{L}_{\Sigma} \times 0.256 \text{ ms}) + 47 \text{ ms}$$

Many devices work at an effective input or output data length of 5 ... 10 Bytes. Thus, the calculation example is close to practical requirements at  $\bar{L}_{\Sigma} = 10 \text{ Bytes}$ :

**Equation 4**

$$T_{SYS} = n \times 11 \text{ ms} + 10 \times 0.256 \text{ ms} + 47 \text{ ms}$$

$$T_{SYS} = n \times 13.56 \text{ ms} + 47 \text{ ms} \text{ --> Diagram 1 } (T_{ID} = 145 \text{ Bit})$$

**Characteristic Curves**

**Diagram 1**

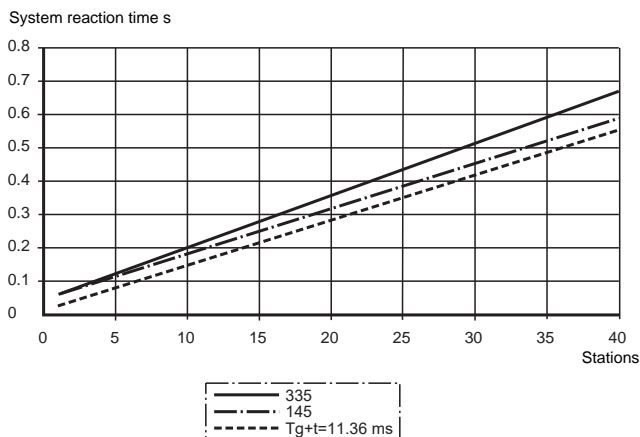

**Diagram 2**

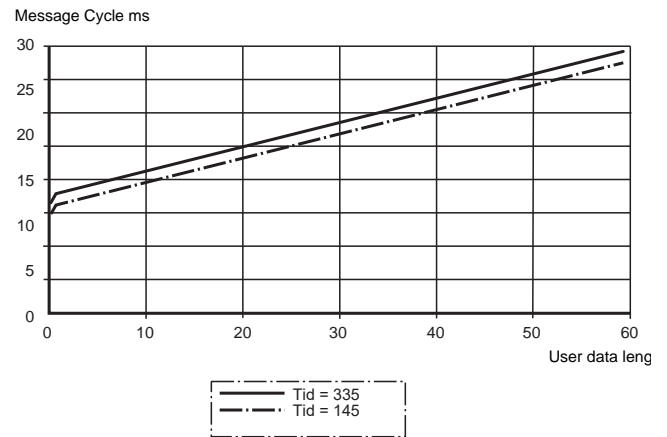

Release date: 2022-07-04 Date of issue: 2022-07-04 Filename: 098314\_eng.pdf

The previous formulas applied for operation at an Idle1 time of 145 Bit. If you are forced to increase the Idle time-1 (see the section entitled Idle1 time), the message cycle will also increase. The calculated times are shown in the diagrams with the  $T_{ID1}$  values of 335 Bit (thin line) recommended in older data sheets.

The following formulas contain the additional parameter  $T_{ID1}$ . The equations are numbered according to the previous equations with an additional index i.

**Equation 1i**

$$T_{MC} = 9.456 \text{ ms} + 0.256 \text{ ms} \times L_{\Sigma} + L_{ID} / 93.75 \text{ kBit/s}$$

**Equation 2i**

$$T_{SYS}^n = n \times (9.456 \text{ ms} + T_{ID} / 93.75 \text{ kBit/s}) + 0.256 \text{ ms} \times \Sigma T_{\Sigma(i)} + 48 \text{ ms}$$

**Equation 3i**

$$T_{SYS} = n \times (9.456 \text{ ms} + T_{ID} / 93.75 \text{ kBit/s} + L_{\Sigma} \times 0.256) + 48 \text{ ms}$$

**Equation 4i**

$$T_{SYS} = n \times (11 \text{ ms} + 10 \times 0.256 \text{ ms}) + 48 \text{ ms}$$

$$T_{SYS} = n \times 13.56 + 47 \text{ ms} \rightarrow \text{Diagram 1 } (T_{ID}) = 145 \text{ Bit}$$

**Indication**

LED display	Meaning	Comments
Yellow On continuously	Communication OK	Light off for time out (of DP line approx. 0.3 s light off with time out of PA line approx. 3 s)
Red On continuously	Hardware error	
Yellow flashing	DP reception error	flashes 3 times when telegram error is detected
Yellow and Red flashing in sync	PA reception error	flashes 3 times when telegram error is detected
Yellow and Red flashing alternately	Collision error sh. Slot time	flashes 3 times when collision error is detected
Green On	Power on	

**Footnotes**

- 1) Index PA applies to 31.25 kBit/s: 1 Bit<sub>PA</sub> = 3 Bit<sub>DP</sub> = 32 μs.
- 2) This special reaction time is not the so-called station delay time T<sub>SDR</sub>.
- 3) The value 4095 Bit applies to the following parameters: L<sub>S</sub> + L<sub>R</sub> < 253 Bytes; T<sub>SDR</sub> = 60 Bit<sub>PA</sub> (1.92 ms). If you would like to allow for data exchange with call-up and response telegram, each with a theoretical maximum length of 246 Bytes (L<sub>S</sub> + L<sub>R</sub> = 492 Bytes), T<sub>SL</sub> should be set to 7192 Bit.
- 4) The unit, byte, is the number of telegram characters (UART characters).
- 5) Most PA bus stations have a T<sub>SDR</sub> of 60 Bit<sub>PA</sub>.
- 6) The time unit bit<sub>PA</sub> applies for the PROFIBUS PA side as 31.25 kBit/s. 1 Bit<sub>PA</sub> = 32 μs .
- 7) SDN telegrams are used for example by the "Global Control" service.
- 8) T<sub>ID2</sub> is calculated from: T<sub>ID2</sub> = max (T<sub>SYN</sub> + T<sub>SM</sub>, max T<sub>SDR</sub> ). The greater value should be placed in parentheses. The relationships between these monitoring times are described in DIN 19 245-1 Section 4.1.7.
- 9) A message cycle includes a call-up telegram, response telegram, reaction time (between call and response) and the pause time until the beginning of the next call (Idle time-1).
- 10) The duration of a token cycle and the system response time are practically identical.
- 11) T<sub>T+G</sub> = 47 ms applies with the following boundary conditions: GAP Update in Worst Case (station address not present. Slot time T<sub>SL</sub> = 4059 Bit; Idle time-1 T<sub>ID1</sub> @ 150 Bit.
- 12) T<sub>T+G</sub> = 47 ms applies with the following boundary conditions: GAP Update with response; Idle time-1 T<sub>ID1</sub> = 145 Bit
- 13) Equation 1 has the following conditions: Idle time-1 = 145 Bit; station delay time of station T<sub>SDR</sub> = 60 Bit<sub>PA</sub> = 180 Bit; call and response have the same telegram format with a variable data field length (SD2).  
The time unit bit<sub>PA</sub> applies for the PROFIBUS PA side as 31.25 kBit/s. 1 Bit<sub>PA</sub> = 32 μs.

Release date: 2022-07-04 Date of issue: 2022-07-04 Filename: 098314\_eng.pdf