

Standstill and Rotational Direction Monitor

KFD2-SR2-Ex2.W.SM

- 2-channel isolated barrier
- 24 V DC supply (Power Rail)
- Dry contact or NAMUR inputs
- Selectable frequency trip values
- 2 relay contact outputs
- Start-up override
- Selectable mode of operation
- Line fault detection (LFD)
- Up to SIL 2 acc. to IEC/EN 61508



Function

This isolated barrier is used for intrinsic safety applications. This device is a standstill monitor that accepts input frequency pulses and triggers an output when the frequency drops below a preselected limit value. Two start-up override values are available. This unit can also be used to determine rotation direction. During an error condition, the relay reverts to its de-energized state and the LEDs indicate the fault according to NAMUR NE 44. The device has LED status indicators for direction of rotation detection, limit detection, supply, and hardware faults. The device is easily configured by the use of DIP switches. If the device is operated via Power Rail, additionally a collective error message is available. For additional information, refer to www.pepperl-fuchs.com.

Connection

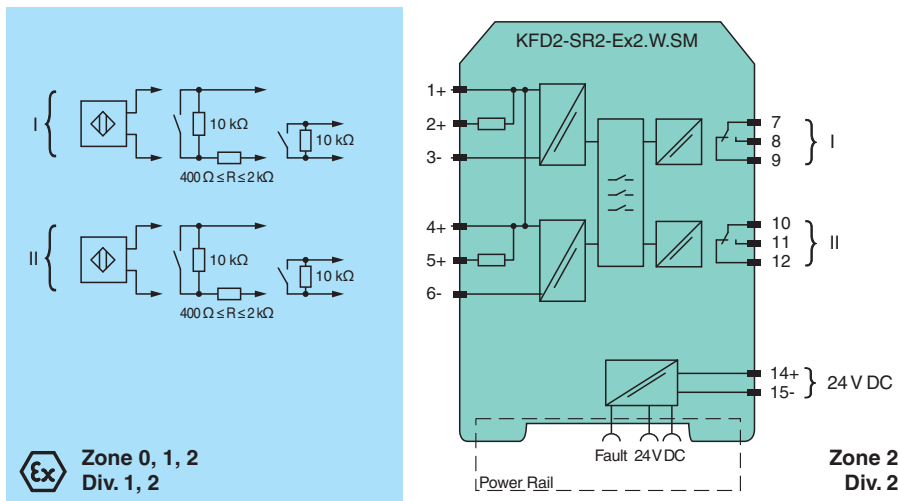

Technical Data

General specifications

| | |
|-------------|---------------------------------|
| Signal type | Digital Input |
| Programming | via DIP switch and programmable |

Functional safety related parameters

| | |
|------------------------------|-------|
| Safety Integrity Level (SIL) | SIL 2 |
|------------------------------|-------|

Supply

| | |
|---------------|----------------------------------|
| Connection | Power Rail or terminals 14+, 15- |
| Rated voltage | U _r 20 ... 30 V DC |

Release date: 2022-07-19 Date of issue: 2022-07-19 Filename: 132964_eng.pdf

Refer to "General Notes Relating to Pepperl+Fuchs Product Information".

Pepperl+Fuchs Group
www.pepperl-fuchs.com

USA: +1 330 486 0002
pa-info@us.pepperl-fuchs.com

Germany: +49 621 776 2222
pa-info@de.pepperl-fuchs.com

Singapore: +65 6779 9091
pa-info@sg.pepperl-fuchs.com



Technical Data

| | | |
|--|------------|--|
| Power consumption | | max. 1.5 W |
| Input | | |
| Connection side | | field side |
| Connection | | Input I: terminals 1+, 2+, 3- ; Input II: terminals 4+, 5+, 6- |
| Rated values | | acc. to EN 60947-5-6 (NAMUR) |
| Open circuit voltage/short-circuit current | | approx. 8 V DC / approx. 8 mA |
| Switching point/switching hysteresis | | 1.2 ... 2.1 mA / approx. 0.2 mA |
| Line fault detection | | breakage $I \leq 0.1$ mA , short-circuit $I > 6$ mA |
| Control input | | sensor power supply approx. 8.2 V, impedance 1.2 k Ω |
| Pulse duration | | > 200 μ s for standstill monitoring, > 250 μ s for rotation direction detection |
| Output | | |
| Connection side | | control side |
| Connection | | output I: terminals 7, 8, 9 ; output II: terminals 10, 11, 12 |
| Contact loading | | 250 V AC/2 A/cos $\phi > 0.75$; 126.5 V AC/4 A/cos $\phi > 0.75$; 40 V DC/2 A resistive load |
| Minimum switch current | | 2 mA / 24 V DC |
| Energized/De-energized delay | | approx. 20 ms / approx. 20 ms |
| Mechanical life | | 10 ⁷ switching cycles |
| Trip value | f_{\max} | for standstill monitoring: 0.1 Hz; 0.5 Hz; 2 Hz; 10 Hz adjustable via DIP switch (S1 and S2) |
| Transfer characteristics | | |
| Accuracy | | 5 % (S3 = I), 30 % (S3 = II) |
| Start-up override | | 5 seconds or 20 seconds, programmable |
| Frequency range | | ≤ 2 kHz |
| Rotation direction detection | | 90° phase difference between pulse input signal 1 and 2, overlapping ≥ 125 μ s |
| Galvanic isolation | | |
| Input/Output | | reinforced insulation according to IEC/EN 61010-1, rated insulation voltage 300 V _{eff} |
| Input/power supply | | reinforced insulation according to IEC/EN 61010-1, rated insulation voltage 300 V _{eff} |
| Output/power supply | | reinforced insulation according to IEC/EN 61010-1, rated insulation voltage 300 V _{eff} |
| Output/Output | | reinforced insulation according to IEC/EN 61010-1, rated insulation voltage 300 V _{eff} |
| Indicators/settings | | |
| Display elements | | LEDs |
| Control elements | | DIP switch |
| Configuration | | via DIP switches |
| Labeling | | space for labeling at the front |
| Directive conformity | | |
| Electromagnetic compatibility | | |
| Directive 2014/30/EU | | EN 61326-1:2013 (industrial locations) |
| Low voltage | | |
| Directive 2014/35/EU | | EN 61010-1:2010 |
| Conformity | | |
| Electromagnetic compatibility | | NE 21:2006 |
| Degree of protection | | IEC 60529:2001 |
| Input | | EN 60947-5-6:2000 |
| Ambient conditions | | |
| Ambient temperature | | -20 ... 60 °C (-4 ... 140 °F) |
| Mechanical specifications | | |
| Degree of protection | | IP20 |
| Connection | | screw terminals |
| Mass | | approx. 150 g |
| Dimensions | | 20 x 119 x 115 mm (0.8 x 4.7 x 4.5 inch) (W x H x D) , housing type B2 |
| Mounting | | on 35 mm DIN mounting rail acc. to EN 60715:2001 |

Release date: 2022-07-19 Date of issue: 2022-07-19 Filename: 132964_eng.pdf

Technical Data





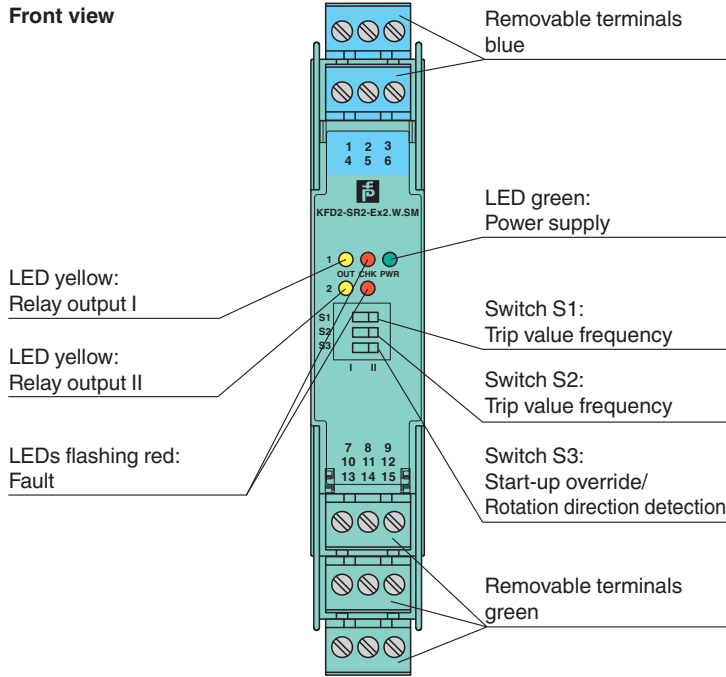

| Data for application in connection with hazardous areas | | |
|---|---|--|
| EU-type examination certificate | PTB 00 ATEX 2080 | |
| Marking | Ⓜ II (1)G [Ex ia Ga] IIC Ⓜ II (1)D [Ex ia Da] IIIC Ⓜ I (M1) [Ex ia Ma] I | |
| Input | Ex ia | |
| Voltage | U _o | 10.5 V |
| Current | I _o | 13 mA |
| Power | P _o | 34 mW (linear characteristic) |
| Supply | | |
| Maximum safe voltage | U _m | 253 V AC / 125 V DC (Attention! U _m is no rated voltage.) |
| Output | | |
| Maximum safe voltage | U _m | 253 V AC (Attention! The rated voltage can be lower.) |
| Fault indication output | | |
| Maximum safe voltage | U _m | 40 V DC (Attention! U _m is no rated voltage.) |
| Certificate | | |
| Marking | TÜV 99 ATEX 1493 X | |
| Output | Ⓜ II 3G Ex ec nC IIC T4 Gc | |
| Contact loading | | |
| Contact loading | 50 V AC/4 A/cos φ > 0.7; 40 V DC/2 A resistive load | |
| Galvanic isolation | | |
| Input/Output | safe electrical isolation acc. to IEC/EN 60079-11, voltage peak value 375 V | |
| Input/power supply | safe electrical isolation acc. to IEC/EN 60079-11, voltage peak value 375 V | |
| Directive conformity | | |
| Directive 2014/34/EU | EN IEC 60079-0:2018+AC:2020 , EN 60079-7:2015+A1:2018 , EN 60079-11:2012 , EN IEC 60079-15:2019 | |
| International approvals | | |
| FM approval | | |
| FM certificate | FM19US0207X | |
| Control drawing | 116-0035 | |
| UL approval | | |
| Control drawing | E106378 | |
| Control drawing | 116-0145 | |
| Contact loading | 250 V AC/2 A/cos φ > 0.75; 126.5 V AC/4 A/cos φ > 0.75; 30 V DC/2 A resistive load | |
| CSA approval | | |
| Control drawing | 116-0047 | |
| IECEx approval | | |
| IECEx certificate | IECEx PTB 11.0034 , IECEx TUN 19.0013X | |
| IECEx marking | [Ex ia Ga] IIC [Ex ia Da] IIIC [Ex ia Ma] I Ex ec nC IIC T4 Gc | |
| General information | | |
| Supplementary information | Observe the certificates, declarations of conformity, instruction manuals, and manuals where applicable. For information see www.pepperl-fuchs.com . | |

Release date: 2022-07-19 Date of issue: 2022-07-19 Filename: 132964_eng.pdf





Assembly



Matching System Components

| | | |
|---|-------------------------|--|
|  | KFD2-EB2 | Power Feed Module |
|  | UPR-03 | Universal Power Rail with end caps and cover, 3 conductors, length: 2 m |
|  | UPR-03-M | Universal Power Rail with end caps and cover, 3 conductors, length: 1,6 m |
|  | UPR-03-S | Universal Power Rail with end caps and cover, 3 conductors, length: 0.8 m |
|  | K-DUCT-BU | Profile rail, wiring comb field side, blue |
|  | K-DUCT-BU-UPR-03 | Profile rail with UPR-03- * insert, 3 conductors, wiring comb field side, blue |

Accessories

| | | |
|---|------------------|--|
|  | F-NR3-Ex1 | NAMUR Resistor Network |
|  | KF-ST-5GN | Terminal block for KF modules, 3-pin screw terminal, green |
|  | KF-ST-5BU | Terminal block for KF modules, 3-pin screw terminal, blue |
|  | KF-CP | Red coding pins, packaging unit: 20 x 6 |

Release date: 2022-07-19 Date of issue: 2022-07-19 Filename: 132964_eng.pdf

Refer to "General Notes Relating to Pepperl+Fuchs Product Information".

Additional Information

The function of standstill monitor with start-up override (S3 = I) or standstill monitor with rotation direction monitoring (S3 = II) can be selected by means of DIP switches.

| S3: | I | II |
|-------------------|--|---|
| Function: | Standstill monitor with start-up override | Standstill monitor with rotation direction monitoring |
| Input I: | Pulse input 1: NAMUR contacts (bounce-free) | Pulse input 1: NAMUR contacts (bounce-free) |
| Input II: | Start-up override: contact terminal 4 + 6: 20 seconds contact terminal 5 + 6: 5 seconds | Pulse input 2: NAMUR contacts (bounce-free) |
| Output I: | MIN/passive | MIN/passive |
| Output II: | MIN/active | Direction of rotation/error |

Standstill monitor with start-up override (S3 = I)

If the frequency falls below the trip value set with the DIP switches S1 and S2, the standstill monitor with start-up override switches the output I to passive and the output II to active. Input I is used to monitor the frequency of rising current edges. Signal transmitters can be sensors in accordance with EN 60947-5-6 (NAMUR) or contacts. Input I is monitored for lead breakage/short-circuiting. A start-up override can be initiated via input II. The duration of the start-up override can be selected between 5 and 20 seconds by means of a bridge (starting trigger) or an external trigger signal. During the start-up override time the outputs assume the "no standstill" state. In this case there is no lead breakage/short-circuit monitoring at input II.

| Trip value | Hysteresis | Switch S2 | Switch S1 |
|------------|------------|-----------|-----------|
| 0.1 Hz | 0.02 Hz | I | I |
| 0.5 Hz | 0.1 Hz | I | II |
| 2 Hz | 0.4 Hz | II | I |
| 10 Hz | 2 Hz | II | II |

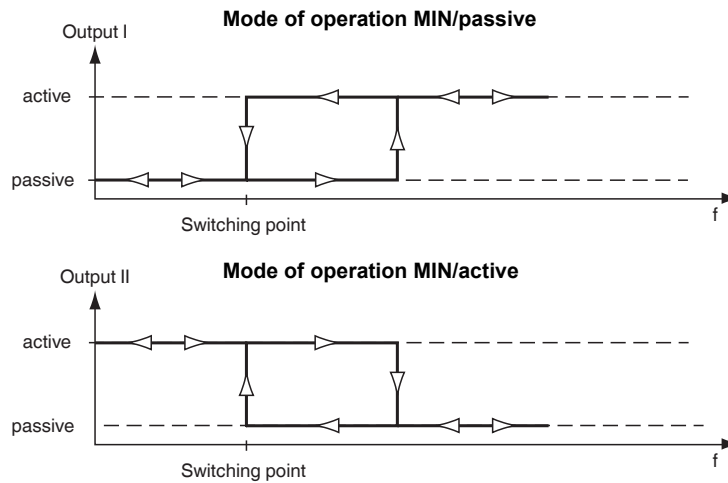

Release date: 2022-07-19 Date of issue: 2022-07-19 Filename: 132964_eng.pdf

Refer to "General Notes Relating to Pepperl+Fuchs Product Information".

Standstill monitor with rotation direction monitoring (S3 = II)

The device also offers stand still monitoring with direction of rotation monitoring as an alternative to stand still monitoring with start-up override. The trip values are identical to the standstill monitor with start-up override. At input II a signal that is offset by 90° to input I has to be applied; in this context minimum signal overlapping should be ensured. Signal transmitters at input I and input II can be sensors in accordance with DIN EN 60947-5-6 (NAMUR) or contacts. Both inputs are monitored for lead faults. Output I is used for standstill signalling and switches to a de-energized state (passive) in the event of a standstill. Output II is switched to active when the direction of rotation is clockwise. If a reverse rotation is detected or if a signal overlap is missing, output II switches to a de-energized state (passive). In this case it can be concluded, that the sensor is misadjusted or defective. If the sensor at input I is misadjusted or defective, input II is used for standstill monitoring.

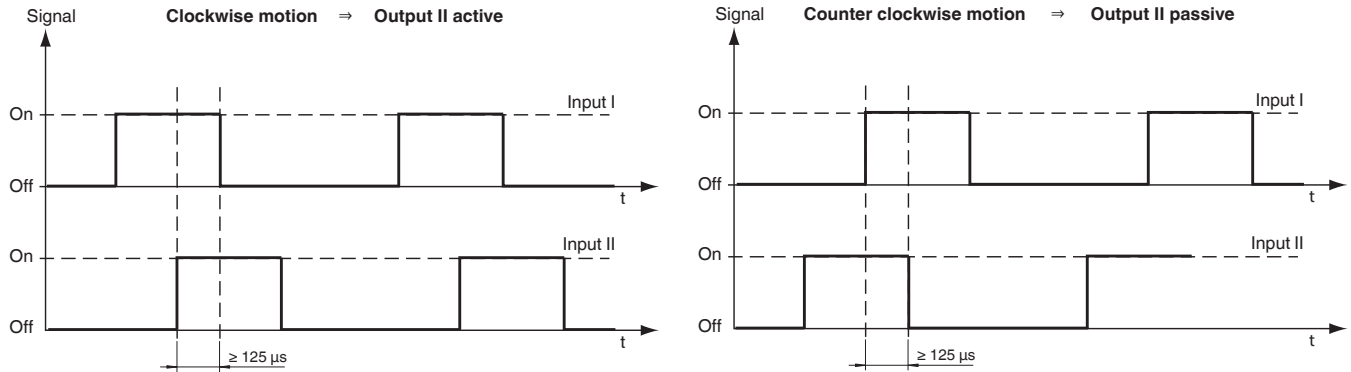
**Behaviour during malfunction:**

- Monitoring for lead faults
- Continuous monitoring of the device for errors in internal memory

If an error occurs, both relays go into the secure state, the red LEDs indicate the error and a collective error message is generated via the Power Rail.

Advice on use in SIL2 applications (Functional safety)

Care should be taken to ensure that the relays are de-energized (passive) in the critical condition of the application. Then, in the event of a power failure (de-energized, passive relay) the safety-critical state (energized) relay cannot be achieved.

Example 1:

The protective guard for a rotating shaft must remain locked in position until the shaft has stopped rotating. The safety-critical condition is the rotation of the shaft (risk of injury). For this reason, the locking of the protective guard should be achieved by means of a de-energized (passive) relay. The relay shall be energized (active) only when the shaft has stopped (safe condition). This device function is only achieved with "Standstill monitoring with start-up override" (S3 = I) and control of the protective guard with relay 2.

Example 2:

The cooling of a critical process by means of fans/coolant pumps has to be monitored. The safety-critical condition is the standstill of the fans/pumps (overheating). For this reason an alarm must be triggered when a relay has de-energized (passive). As long as the fans or the pumps are running (safety condition) the relay is energized (active). This device function can be achieved with "Standstill monitoring with start-up override" (S3 = I) and "Standstill monitoring with direction of rotation signalling" (S3 = II) with relay 1.

Characteristic Curve**Maximum switching power of output contacts**

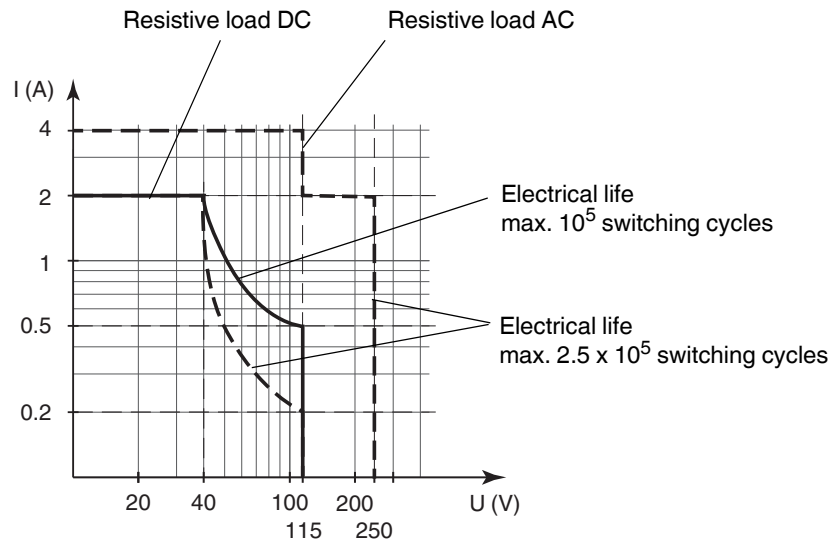

The maximum number of switching cycles is depending on the electrical load and may be higher when reduced currents and voltages are applied.