

PROFIBUS Power Hub, Gateway Module

HD2-GTR-4PA

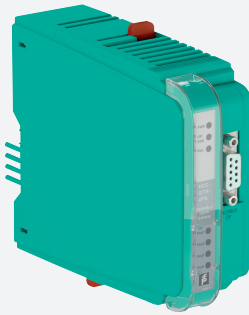

- PROFIBUS DP V1 / For 4 segments PA
- Couples PROFIBUS PA devices transparently to PROFIBUS DP
- Optional redundant configuration
- Installation in Zone 2/Class I, Div. 2
- Up to 12 Mbit/s, auto adapting
- For redundant and non-redundant masters
- Supports Flying Redundancy (FR)
- Cyclic/acyclic data exchange



Function

The PROFIBUS Power Hub gateway is a system component of the FieldConnex[®] PROFIBUS Power Hub (Segment Coupler 3 or SK3) and plugs into the gateway motherboard. The gateway operates with power supply modules connected to the same or a separate motherboard. This system component transparently couples PROFIBUS DP with up to 4 PROFIBUS PA segments. Communication is transparent between DP and PA. The gateway of the Segment Coupler makes each PA device appear as if it was connected to DP: This relates to addressing, cyclic/acyclic data exchange, and the transfer rate. Segment design is clear and easy to understand without subnetworks. The gateway itself is configuration-free. All in all, these features significantly reduce engineering work. The gateway provides a PA master for each segment and thus enables short bus cycle times. In redundant configuration, 2 PROFIBUS gateway modules operate with handshake between each communication. During redundancy transfer, communication is seamless for DP master and field devices, ensuring continued plant operation. Internal status is reported via volt-free contact and via diagnostic telegram on PROFIBUS DP.

Connection

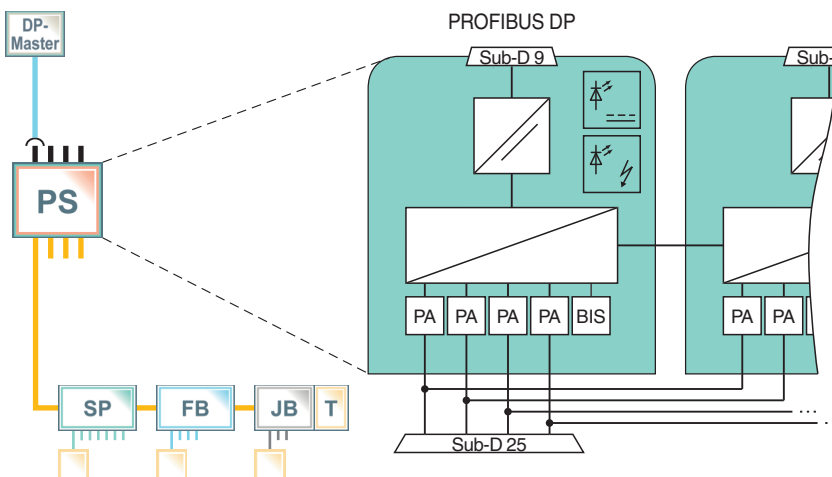

Technical Data

General specifications

Design / Mounting Motherboard based

Supply

Rated voltage	U_r	19.2 ... 35 V DC
Rated current	I_r	160 ... 90 mA
Power dissipation		3 W

Fieldbus connection

PROFIBUS DP

Technical Data

Connection	9-pin Sub-D socket
Protocol	PROFIBUS DP V1
Indicators/operating means	
LED Seg 1...4	red 2 Hz flashing: PA error, red and LED DP/ERR red: MAU error
LED PWR	green: Power on
LED DP/ERR	red 2 Hz flashing: DP error ; red: Hardware error
LED Red.	yellow: redundant operation primary device ; yellow 2 Hz flashing: synchronization or redundancy not available
Galvanic isolation	
CH/PROFIBUS DP	functional insulation acc. to IEC 62103, rated insulation voltage 50 V _{eff}
PROFIBUS DP/Supply	functional insulation acc. to IEC 62103, rated insulation voltage 50 V _{eff}
CH/CH	functional insulation acc. to IEC 62103, rated insulation voltage 50 V _{eff}
All circuits/FE	functional insulation acc. to IEC 62103, rated insulation voltage 50 V _{eff}
Directive conformity	
Electromagnetic compatibility	
Directive 2014/30/EU	EN 61326-1:2013
Low voltage	
Directive 73/23/EEC	EN 50178 (identical to EN 62103)
Standard conformity	
Galvanic isolation	IEC 62103
Electromagnetic compatibility	NE 21:2011
Degree of protection	IEC 60529
Fieldbus standard	IEC 61158-2
Shock resistance	EN 60068-2-27
Vibration resistance	EN 60068-2-6
Ambient conditions	
Ambient temperature	-40 ... 60 °C (-40 ... 140 °F)
Storage temperature	-40 ... 85 °C (-40 ... 185 °F)
Relative humidity	< 95 % non-condensing
Shock resistance	15 g 11 ms
Vibration resistance	1 g , 10 ... 150 Hz
Pollution degree	max. 2, according to IEC 60664
Corrosion resistance	acc. to ISA-S71.04-1985, severity level G3
Mechanical specifications	
Housing material	Polycarbonate
Housing width	40 mm
Housing height	106 mm
Housing depth	128 mm
Degree of protection	IP20
Mass	250 g
Mounting	motherboard mounting , mounting in any orientation
Data for application in connection with hazardous areas	
Certificate	TÜV 04 ATEX 2500 X
Marking	Ⓜ II 3 G Ex nA IIC T4 Gc
Directive conformity	
Directive 2014/34/EU	EN 60079-0:2012 , EN 60079-11:2012 , EN 60079-15:2010
International approvals	
FM approval	
FM certificate	FM 19 US 0015 X and FM 19 CA 0011 X
FM marking	AEx/Ex ec IIC T4
IECEX approval	
IECEX certificate	IECEX TUN 13.0038X
IECEX marking	Ex nA IIC T4 Gc

Release date: 2022-07-04 Date of issue: 2022-07-04 Filename: 180563_eng.pdf



Technical Data

Certificates and approvals	
Marine approval	DNV A-14038
General information	
Supplementary information	Observe the certificates, declarations of conformity, instruction manuals, and manuals where applicable. For information see www.pepperl-fuchs.com .

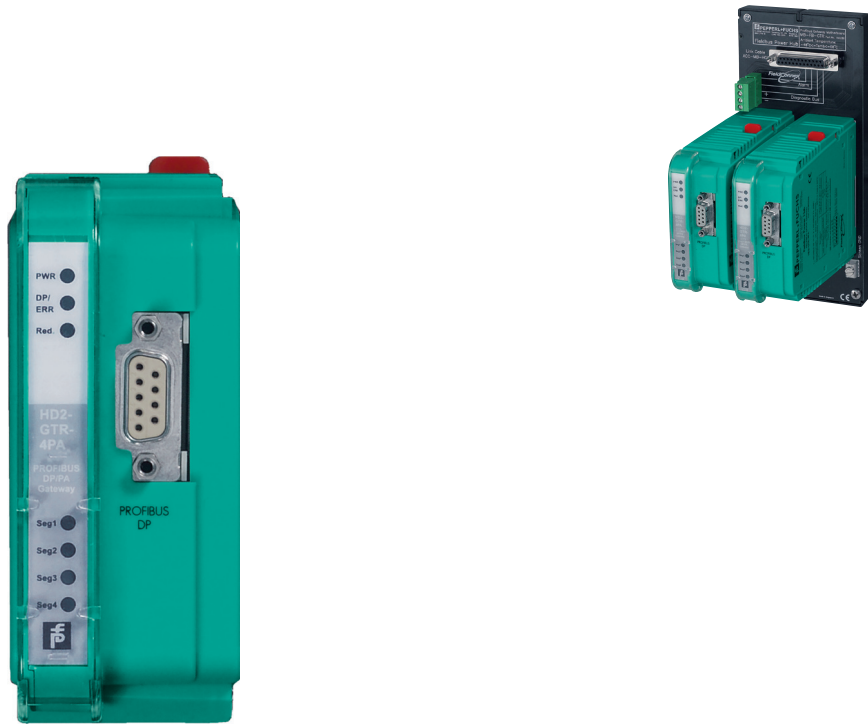

Assembly



Matching System Components

	MB-FB-GTR	Universal PROFIBUS Power Hub, Gateway Motherboard
	MBHC-FB-4.GT*	Fieldbus Power Hub, Motherboard for Gateway and Power Supply Modules

Accessories

	DTM FieldConnex	FieldConnex® DTM Collection
	PACTware 5.0	FDT Framework
	PACTware 4.1	FDT Framework

Release date: 2022-07-04 Date of issue: 2022-07-04 Filename: 180563_eng.pdf

Additional Information

Dimensions and Assembly

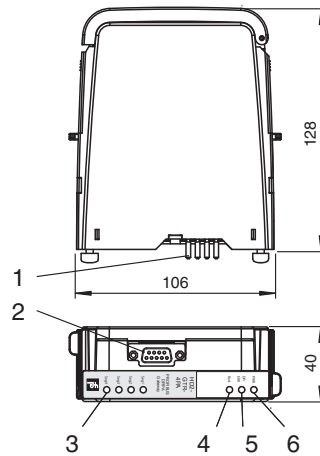

Description:

- 1 Plug connections to motherboard
- 2 PROFIBUS DP interface
- 3 LED Seg 1 ... Seg 4:
- Red flashing with 2 Hz: PA error, double slave address
- 4 LED Redundancy:
- Yellow constant: Redundancy operation primary device
- Yellow flashing: Synchronization
- 5 LED DP/Error:
- Red flashing with 2 Hz: DP error
- Red constant: Hardware error
- 6 LED Power:
- Green: Power on

Release date: 2022-07-04 Date of issue: 2022-07-04 Filename: 180563_eng.pdf

Refer to "General Notes Relating to Pepperl+Fuchs Product Information".

Pepperl+Fuchs Group
www.pepperl-fuchs.com

USA: +1 330 486 0002
pa-info@us.pepperl-fuchs.com

Germany: +49 621 776 2222
pa-info@de.pepperl-fuchs.com

Singapore: +65 6779 9091
pa-info@sg.pepperl-fuchs.com