

RFID read/write device

IQH1-18GM-V1

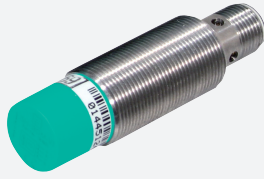

- Operating frequency 13.56 MHz
- Conforms to ISO 15693
- Suitable for FRAM transponder
- Read/write head with thread M18 x 1
- Connection via V1 (M12 x 1) plug connection
- Multihole-LED for function display
- Degree of protection IP67
- For connection to IDENTControl control interface

HF RFID read/write device, ISO 15693, for IDENTControl



Dimensions

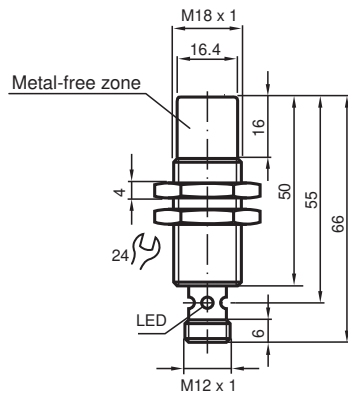

Technical Data

General specifications	
Operating frequency	13.56 MHz
Transfer rate	26 kBit/s
Sensing range	
Read distance	0 ... 50 mm
Write distance	0 ... 50 mm
Width	max. 45 mm
UL File Number	E87056 only from low voltage, limited energy source (SELV or PELV) or listed Class 2 source
MTBF	375 a (Operation at +40 °C)
Indicators/operating means	
LED green/yellow	Multihole-LED: green: power on green flashing: read/write attempt performed yellow: data carrier detected
Electrical specifications	
Power consumption	P ₀ ≤ 1.2 W
Supply	from the IDENTControl
Directive conformity	

Release date: 2023-08-07 Date of issue: 2023-08-07 Filename: 204622_eng.pdf

Refer to "General Notes Relating to Pepperl+Fuchs Product Information".

Pepperl+Fuchs Group
www.pepperl-fuchs.com

USA: +1 330 486 0001
fa-info@us.pepperl-fuchs.com

Germany: +49 621 776 1111
fa-info@de.pepperl-fuchs.com

Singapore: +65 6779 9091
fa-info@sg.pepperl-fuchs.com

PEPPERL+FUCHS

Technical Data

Radio equipment	
Directive 2014/53/EU	EN 301489-1 EN 301489-3 EN 300330 EN 62368-1 EN 50364
RoHS	
Directive 2011/65/EU (RoHS)	IEC/EN 63000
Standard conformity	
Degree of protection	EN 60529
RFID	ISO/IEC 15693-2 ISO/IEC 15693-3 ISO/IEC 18000-3
Approvals and certificates	
FCC approval	This device complies with part 15 of the FCC rules. Operation is subject to the following two conditions: (1) This device may not cause harmful interference, and (2) This device must accept any interference received, including interference that may cause undesired operation. Caution: Changes or modifications not expressly approved by the party responsible for compliance could void the user's authority to operate the equipment.
KCC approval	KCC-CRI-PF1-IQH1-18GM-V1
MIC approval	AC-14014
NCC approval	CCAM15LP0280T3
Radio approval	USA: FCC IREIQH1-18GM-V1
Ambient conditions	
Ambient temperature	-25 ... 70 °C (-13 ... 158 °F)
Storage temperature	-40 ... 85 °C (-40 ... 185 °F)
Mechanical specifications	
Housing length	66 mm
Housing diameter	18 mm
Degree of protection	IP67
Connection	connector M12 x 1
Material	
Housing	PBT/stainless steel
Encapsulation compound	CY 221/HY 2966
Installation	
Distance between two heads	Multiplex on: ≥ 30 mm Multiplex off: ≥ 80 mm
Mass	approx. 40 g



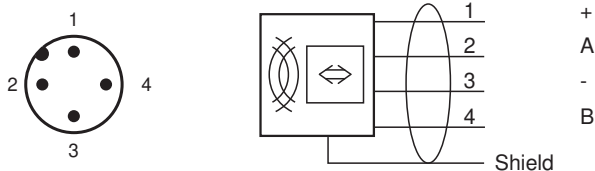

















Connection



Safety Information

This equipment has been tested and found to comply with the limits for a Class A digital device, pursuant to part 15 of the FCC Rules. These limits are designed to provide reasonable protection against harmful interference when the equipment is operated in a commercial environment. This equipment generates, uses, and can radiate radio frequency energy and, if not installed and used in accordance with the instruction manual, may cause harmful interference to radio communications. Operation of this equipment in a residential area is likely to cause harmful interference in which case the user will be required to correct the interference at his own expense.

Accessories



	IC-KP-B6-V15B	Control interface unit IDENTControl with PROFIBUS DP interface
	IC-KP-B17-AIDA1	IDENTControl control interface with Ethernet interface for TCP/IP, PROFINET, EtherNet/IP, and MODBUS TCP protocols
	IC-KP2-2HRX-2V1	Control interface unit IDENTControl Compact with serial interface RS-232 and RS-485
	IC-KP2-2HB6-V15B	Control interface unit IDENTControl Compact with interface for PROFIBUS DP
	IC-KP2-2HB17-2V1D	IDENTControl Compact control interface with Ethernet interface for TCP/IP, PROFINET, EtherNet/IP, and MODBUS TCP protocols
	IC-KP2-2HB21-2V1D	Control interface unit IDENTControl Compact with EtherCAT interface
	IQC21-8 10pcs	Data carrier
	IQC21-10 10pcs	Data carrier
	IQC21-12.4 10pcs	Data carrier
	IQC21-50F-T10	Data carrier
	IQC21-58	Data carrier
	IQC22-22-T9 50pcs	Data carrier
	IQC33-20 50pcs	Data carrier
	V1-G-2M-PUR-ABG-V1-W	Cordset M12 socket straight to M12 plug angled A-coded, 4-pin, PUR cable grey, shielded
	V1-G-5M-PUR-ABG-V1-W	Cordset M12 socket straight to M12 plug angled A-coded, 4-pin, PUR cable grey, shielded
	V1-G-10M-PUR-ABG-V1-W	Cordset M12 socket straight to M12 plug angled A-coded, 4-pin, PUR cable grey, shielded
	IQC33-50 25pcs	Data carrier
	IQC21-50 25pcs	Data carrier
	IQC33-30 25pcs	Data carrier
	IQC21-30 25pcs	Data carrier

Release date: 2023-08-07 Date of issue: 2023-08-07 Filename: 204622_eng.pdf

Refer to "General Notes Relating to Pepperl+Fuchs Product Information".

Pepperl+Fuchs Group
www.pepperl-fuchs.comUSA: +1 330 486 0001
fa-info@us.pepperl-fuchs.comGermany: +49 621 776 1111
fa-info@de.pepperl-fuchs.comSingapore: +65 6779 9091
fa-info@sg.pepperl-fuchs.com **PEPPERL+FUCHS**

Accessories

	IQC21-16 50pcs	Data carrier
	IQC21-10	Data carrier

Release date: 2023-08-07 Date of issue: 2023-08-07 Filename: 204622_eng.pdf

Refer to "General Notes Relating to Pepperl+Fuchs Product Information".

Pepperl+Fuchs Group
www.pepperl-fuchs.com

USA: +1 330 486 0001
fa-info@us.pepperl-fuchs.com

Germany: +49 621 776 1111
fa-info@de.pepperl-fuchs.com

Singapore: +65 6779 9091
fa-info@sg.pepperl-fuchs.com