

# Ultrasonic sensor

## UB300-18GM40-I-V1



- Short design, 40 mm
- Function indicators visible from all directions
- Analog output 4 mA ... 20 mA
- Measuring window adjustable
- Program input
- Temperature compensation

Single head system



### Dimensions

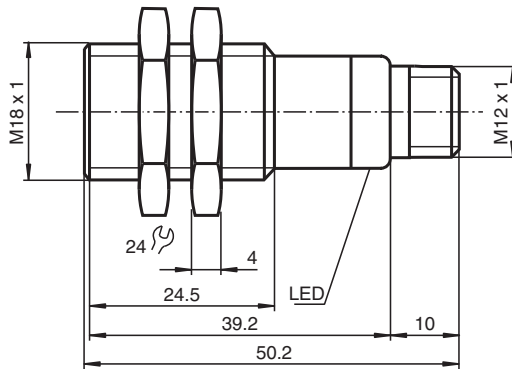

### Technical Data

#### General specifications

Sensing range	35 ... 300 mm
Adjustment range	50 ... 300 mm
Dead band	0 ... 35 mm
Standard target plate	100 mm x 100 mm
Transducer frequency	approx. 390 kHz
Response delay	approx. 50 ms

#### Indicators/operating means

LED green	Power on
-----------	----------

## Technical Data

LED yellow		solid yellow: object in the evaluation range yellow, flashing: program function, object detected
LED red		solid red: Error red, flashing: program function, object not detected
<b>Electrical specifications</b>		
Operating voltage	$U_B$	10 ... 30 V DC , ripple 10 % <sub>SS</sub>
No-load supply current	$I_0$	≤ 20 mA
<b>Input</b>		
Input type		1 program input lower evaluation limit A1: $-U_B \dots +1$ V, upper evaluation limit A2: $+4$ V ... $+U_B$ input impedance: > 4.7 kΩ, pulse duration: ≥ 1 s
<b>Output</b>		
Output type		1 analog output 4 ... 20 mA, short-circuit/overload protected
Default setting		evaluation limit A1: 50 mm evaluation limit A2: 300 mm
Resolution		0.4 mm at max. sensing range
Deviation of the characteristic curve		± 1 % of full-scale value
Repeat accuracy		± 0.5 % of full-scale value
Load impedance		0 ... 300 Ohm
Temperature influence		± 1.5 % of full-scale value
<b>Compliance with standards and directives</b>		
Standard conformity		
Standards		EN IEC 60947-5-2:2020 IEC 60947-5-2:2019 EN 60947-5-7:2003 IEC 60947-5-7:2003
<b>Approvals and certificates</b>		
UL approval		cULus Listed, Class 2 Power Source
CCC approval		CCC approval / marking not required for products rated ≤36 V
<b>Ambient conditions</b>		
Ambient temperature		-25 ... 70 °C (-13 ... 158 °F)
Storage temperature		-40 ... 85 °C (-40 ... 185 °F)
<b>Mechanical specifications</b>		
Connection type		Connector plug M12 x 1 , 4-pin
Housing diameter		18 mm
Degree of protection		IP67
Material		
Housing		brass, nickel-plated
Transducer		epoxy resin/hollow glass sphere mixture; foam polyurethane, cover PBT
Mass		25 g

## Connection

Standard symbol/Connections:  
(version I)

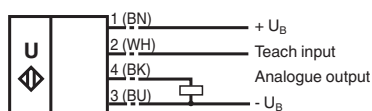

Core colours in accordance with EN 60947-5-2.

## Connection Assignment



Wire colors in accordance with EN 60947-5-2

1	BN	(brown)
2	WH	(white)
3	BU	(blue)
4	BK	(black)

## Characteristic Curve

### Characteristic response curve

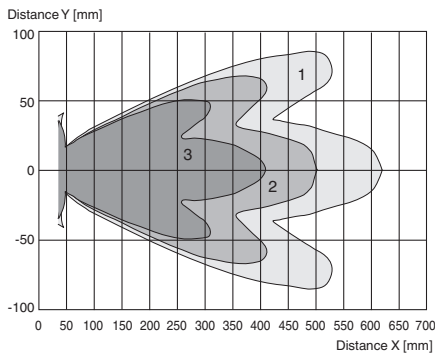

Curve 1: flat surface 100 mm x 100 mm  
 Curve 2: flat surface 10 mm x 10 mm  
 Curve 3: round bar, Ø 25 mm

### Programming the analog output mode

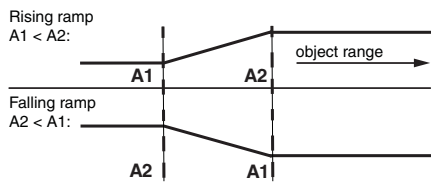







Release date: 2023-07-13 Date of issue: 2023-07-14 Filename: 220360\_eng.pdf

## Accessories

	<b>UB-PROG2</b>	Programming unit
	<b>OMH-04</b>	Mounting aid for round steel ø 12 mm or sheet 1.5 mm ... 3 mm

Refer to "General Notes Relating to Pepperl+Fuchs Product Information".

**Accessories**

	<b>BF 18</b>	Mounting flange, 18 mm
	<b>BF 18-F</b>	Plastic mounting adapter, 18 mm
	<b>BF 5-30</b>	Universal mounting bracket for cylindrical sensors with a diameter of 5 ... 30 mm
	<b>V1-G-2M-PVC</b>	Female cordset single-ended M12 straight A-coded, 4-pin, PVC cable grey
	<b>V1-W-2M-PUR</b>	Female cordset single-ended M12 angled A-coded, 4-pin, PUR cable grey
	<b>UVW90-K18</b>	Ultrasonic -deflector
	<b>M18K-VE</b>	Plastic nuts with centering ring for the vibration-free mounting of cylindrical sensors

Release date: 2023-07-13 Date of issue: 2023-07-14 Filename: 220360\_eng.pdf

Refer to "General Notes Relating to Pepperl+Fuchs Product Information".

Pepperl+Fuchs Group  
www.pepperl-fuchs.com

USA: +1 330 486 0001  
fa-info@us.pepperl-fuchs.com

Germany: +49 621 776 1111  
fa-info@de.pepperl-fuchs.com

Singapore: +65 6779 9091  
fa-info@sg.pepperl-fuchs.com

## Programming

### Programming procedure

The sensor features a programmable analog output with two programmable evaluation boundaries. Programming the evaluation boundaries and the operating mode is done by applying the supply voltage  $-U_B$  or  $+U_B$  to the Teach-In input. The supply voltage must be applied to the Teach-In input for at least 1 s. LEDs indicate whether the sensor has recognized the target during the programming procedure.

#### Note:

Evaluation boundaries may only be specified directly after Power on. A time lock secures the adjusted switching points against unintended modification 5 minutes after Power on. To modify the evaluation boundaries later, the user may specify the desired values only after a new Power On.

#### Note:

If a programming adapter UB-PROG2 is used for the programming procedure, button A1 is assigned to  $-U_B$  and button A2 is assigned to  $+U_B$ .

### Programming the analog output

#### Rising ramp

1. Place the target at the near end of the desired evaluation range
2. Program the evaluation boundary by applying  $-U_B$  to the Teach-In input (yellow LED flashes)
3. Disconnect the Teach-In input from  $-U_B$  to save the evaluation boundary
4. Place the target at the far end of the desired evaluation range
5. Program the evaluation boundary by applying  $+U_B$  to the Teach-In input (yellow LED flashes)
6. Disconnect the Teach-In input from  $+U_B$  to save the evaluation boundary

#### Falling ramp

1. Place the target at the far end of the desired evaluation range
2. Program the evaluation boundary by applying  $-U_B$  to the Teach-In input (yellow LED flashes)
3. Disconnect the Teach-In input from  $-U_B$  to save the evaluation boundary
4. Place the target at the near end of the desired evaluation range
5. Program the evaluation boundary by applying  $+U_B$  to the Teach-In input (yellow LED flashes)
6. Disconnect the Teach-In input from  $+U_B$  to save the evaluation boundary

## Installation Conditions

If the sensor is installed at places, where the environment temperature can fall below 0 °C, for the sensors fixation, one of the mounting flanges BF18, BF18-F or BF 5-30 must be used.

In case of direct mounting of the sensor in a through hole using the steel nuts, it has to be fixed at the middle of the housing thread. If a fixation at the front end of the threaded housing is required, plastic nuts with centering ring (accessories) must be used.