



Radar sensor

RaDec-D



- Microwave motion sensor with intelligent functions
- Reliable detection of people and vehicles
- Simplest adjustment of the sensing range
- Wall and ceiling mountable
- Version with direction detection and cross-traffic suppression

Standard radar motion sensor with additional functions, dynamic version with rotation direction monitoring, detection range 2 m x 4.5 m, max. installation height 4 m, black housing, relay contact output, cable connection



Function

The RaDec series consists of affordable radar motion sensors that not only combine all the key requirements of door manufacturers in a compact, stylish device, but are also user friendly and easy to install. An integrated microprocessor with 24 GHz microwave technology ensures a high level of reliability, even in difficult conditions. What's more, the sensor offers two adjustable detection areas, different operating modes, and an installation height of up to 4 m, and operates in a temperature range of -20 °C ... +60 °C. The -D version features rotation direction monitoring; a cross-traffic suppression system can also be connected to this version.

Dimensions

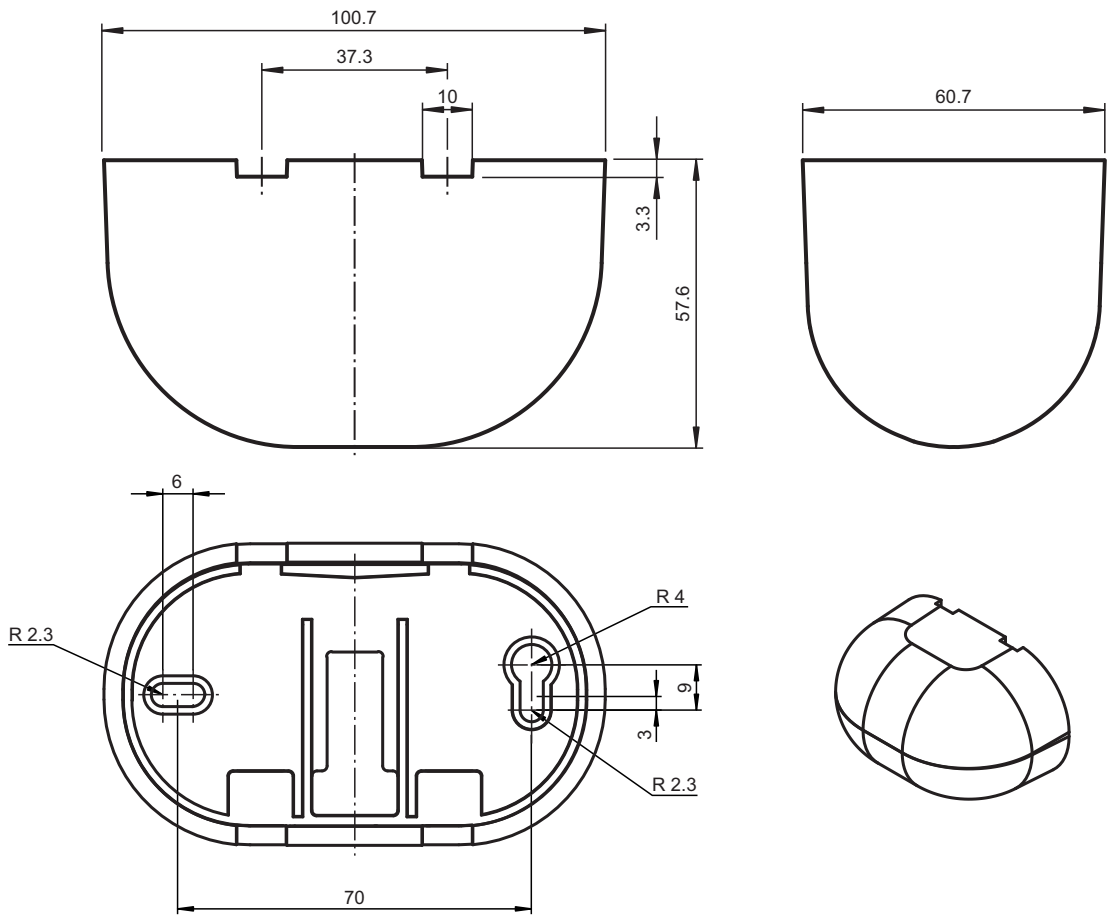

Technical Data

General specifications	
Sensing range	Wide: 2000 x 4500 mm (DxW) at 2200 mm mounting height and 30° inclination angle narrow: 4500x 2000 mm (DxW) at 2200 mm mounting height and 30° inclination angle
Function principle	Microwave module
Detection speed	min. 0.1 m/s
Setting angle	0 ... 90 ° in 5 ° increments
Operating frequency	24.15 ... 24.25 GHz K-Band
Operating mode	Radar motion sensor
Transmitter radiated power (EIRP)	< 20 dBm
Functional safety related parameters	
MTTF _d	300 a
Mission Time (T _M)	20 a
Diagnostic Coverage (DC)	0 %
Indicators/operating means	
Function indicator	LED red
Control elements	potentiometer , DIP switch for selection of operating modes
Control elements	sensitivity adjustment
Electrical specifications	
Operating voltage	U _B 12 ... 36 V DC , 12 ... 28 V AC
No-load supply current	I ₀ ≤ 50 mA at 24 V DC
Power consumption	P ₀ ≤ 1.7 W
Output	

Release date: 2023-03-28 Date of issue: 2023-03-28 Filename: 224402_eng.pdf

Technical Data

Switching type	NO/NC	
Signal output		relay
Switching voltage	max. 48 V AC / 48 V DC	
Switching current	max. 0.5 A AC / 1 A DC	
Switching power	max. 24 W / 60 VA	
De-energized delay	t _{off}	1 s
Approvals and certificates		
CE conformity	2014/53/EU This device can be used in all countries within the European Union. In other countries, all applicable national regulations must be observed.	
FCC approval	No - Use in North America is not permitted.	
Ambient conditions		
Operating temperature	-20 ... 60 °C (-4 ... 140 °F)	
Storage temperature	-30 ... 70 °C (-22 ... 158 °F)	
Relative humidity	max. 90 % non-condensing	
Mechanical specifications		
Mounting height	max. 4000 mm	
Degree of protection	IP54	
Connection	Connecting cable 2.5 m included with delivery	
Material		
Housing	black polycarbonate (PC)	
Mass	130 g	
Dimensions	101 mm x 60 mm x 59 mm	
Suitable series		
Series	RaDec	

Connection Assignment

Option:

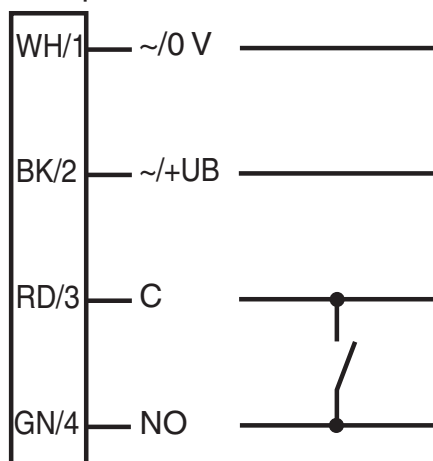

Assembly

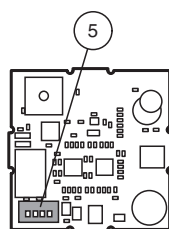
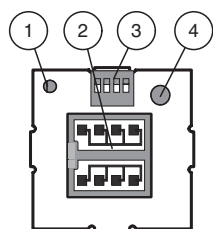



1	LED red
2	Antenna
3	DIP switch
4	Potentiometer
5	Connector

Release date: 2023-03-28 Date of issue: 2023-03-28 Filename: 224402_eng.pdf

Application



Accessories

	<p>RaDec Weather Cap</p>	<p>Weather hood for radar sensors series RaDec</p>
	<p>RMS/RaDec Ceiling Kit wh</p>	<p>Ceiling mount kit for radar sensors in the RMS and RaDec Series</p>

Release date: 2023-03-28 Date of issue: 2023-03-28 Filename: 224402_eng.pdf

Refer to "General Notes Relating to Pepperl+Fuchs Product Information".

Pepperl+Fuchs Group
www.pepperl-fuchs.com

USA: +1 330 486 0001
fa-info@us.pepperl-fuchs.com

Germany: +49 621 776 1111
fa-info@de.pepperl-fuchs.com

Singapore: +65 6779 9091
fa-info@sg.pepperl-fuchs.com

Function

Detection area

A wide or narrow detection area can be set by turning the PCB.

Detection area wide (Standard)

Detection area narrow

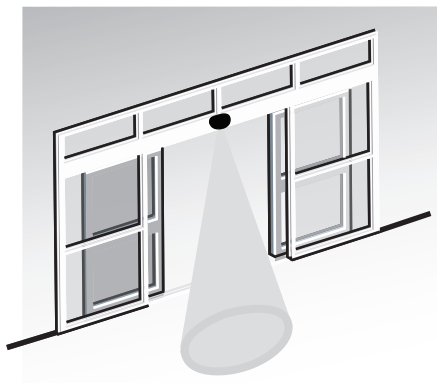
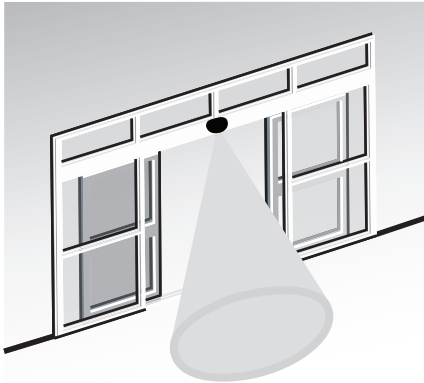

The size of the detection area can be changed using the potentiometer.

With the standard locking discs (already fitted in supplied device) you can set the position of the inclination angle in 10° or 5° increments from 0° to 90°.

By using the supplied locking discs for an inclined detection area (e.g. in revolving doors) the detection field can be rotated 15° left or right.

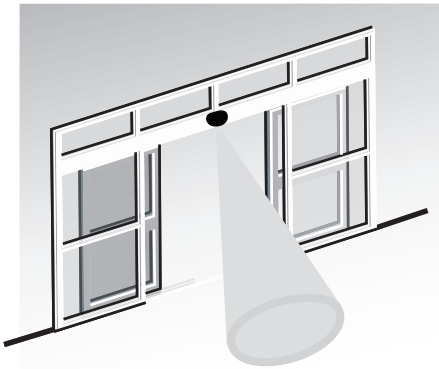

Detection capabilities

Direction detection

With direction detection, it can be set whether the sensor should be triggered by forward movements only or by forward and backward movements.

Cross-traffic suppression

Cross traffic suppression allows for passers-by to be partially suppressed.

Immunity

Immunity allows various external interferences, e.g. rain, vibrations and reflections to be minimized.

Relay contact switching mode

Relay contact when detection is active (NO)

Relay contact when detection is passive (NC)

The setting of the detection capabilities takes place with the DIP switch. The settings are checked by walking in the sensing area.

Function Principle

Radar sensors are microwave sensors that adopt the principle of Doppler radar. The most important requirement for microwave detection is that the object to be detected is moving. Applications include controlling automatic doors and gates.

The sensor emits microwaves of a defined frequency in order to detect people and large objects moving at speeds between 100

Release date: 2023-03-28 Date of issue: 2023-03-28 Filename: 224402_eng.pdf

Refer to "General Notes Relating to Pepperl+Fuchs Product Information".

mm/sec. and 5 m/sec. Stationary people or objects are not detected. Based on the latest 24 GHz technology with integrated microprocessor control, these sensors provide a high level of reliability, even in difficult operating conditions. The 24 GHz frequency, known as the 'K-band,' is reserved by CETECOM for this application area worldwide.

The direction detection function makes it possible to distinguish whether persons are moving towards the door or away from it. It is necessary to trigger the opening impulse if people are approaching the door. The sensor ignores objects that are moving away. Cross-traffic suppression serves a similar purpose. Automatic doors are often opened when a pedestrian walks too close to a shop window or a building facade. The cross-traffic suppression function can avoid this, because microwave technology combined with the microprocessor evaluation unit accurately detects these directions of motion. Both functions noticeably quiet the door area, increase the lifetime of the door mechanism, and in doing so help save energy.

Application

- Opening impulse sensors for automatic doors and industrial doors
- Monitoring approach areas to elevators
- Motion sensors for people and objects
- Impulse sensors for escalators