



Model Number

V3-WM

Female connector, M8, 3-pin, field attachable

Features

- Solder connection
- Gold plated contacts

Dimensions

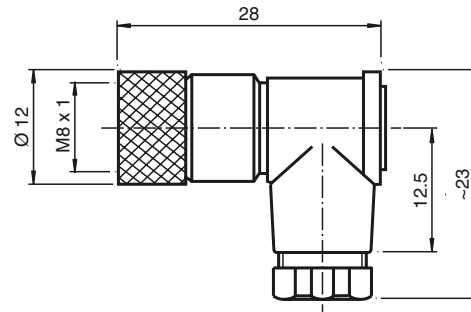

Technical data

General specifications

Number of pins	3
Connection 1	female connector
Construction type 1	right angle
Threading 1	M8

Electrical specifications

Operating voltage	U_B	max. 60 V AC/DC
Operating current		max. 4 A
Volume resistance		< 3 m Ω

Ambient conditions

Ambient temperature	-25 ... 85 °C (-13 ... 185 °F)
Pollution Degree	3

Mechanical specifications

Protection degree	IP67
Connection	1 x M8 socket, right-angled Solder connection for max. 0.25 mm ²

Material

Contacts	CuSn
Contact surface	Au
Body	PA, black
Slotted nut	Diecast zinc
Cable	
Sheath diameter	3.5 ... 5 mm
Flammability	
Contact material	UL 94 HB

Electrical connection

