

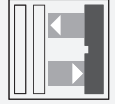

Triangulation sensor (BGE)

OB230-R3-E2-1T



- 45° cable outlet for maximum mounting freedom under extremely tight space constraints
- Improvement in machine availability with abrasion-resistant, antistatic glass front
- Detection of flat objects in front of a close background
- Highly visible light spot, even on dark materials

Triangulation sensor with background evaluation for standard applications, miniature design, 30 mm detection range, red light, light on, PNP output, fixed cable



The nano sensor has been developed for a broad range of applications. It offers excellent durability and is exceptionally easy to install. The housing is compact and, with its 45° cable outlet, can be installed in the smallest spaces. New functional principles and functionality open up a range of new options.

Dimensions

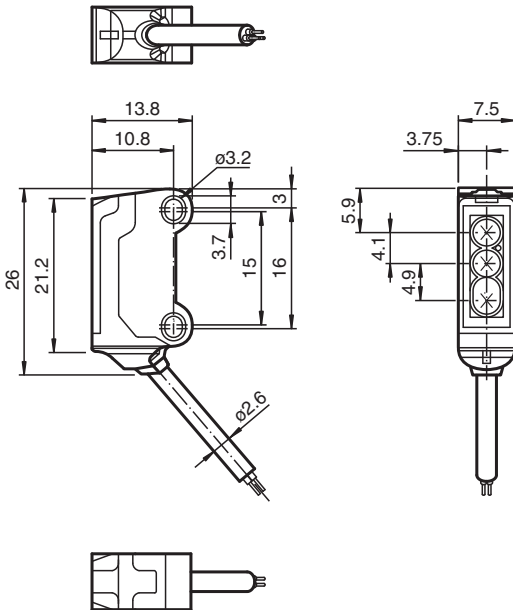

Technical Data

General specifications

Detection range	0 ... 30 mm
Reference target	standard white, 100 mm x 100 mm
Light source	LED
Light type	modulated visible red light , 630 nm
Angle deviation	approx. 2 °
Diameter of the light spot	approx. 2 mm at a distance of 30 mm
Opening angle	approx. 2 °
Optical face	frontal
Ambient light limit	EN 60947-5-2 : 30000 Lux

Functional safety related parameters

Release date: 2022-06-03 Date of issue: 2022-06-03 Filename: 269720_eng.pdf

Refer to "General Notes Relating to Pepperl+Fuchs Product Information".

Pepperl+Fuchs Group
www.pepperl-fuchs.com

USA: +1 330 486 0001
fa-info@us.pepperl-fuchs.com

Germany: +49 621 776 1111
fa-info@de.pepperl-fuchs.com

Singapore: +65 6779 9091
fa-info@sg.pepperl-fuchs.com

PF PEPPERL+FUCHS

Technical Data

MTTF _d		800 a
Mission Time (T _M)		20 a
Diagnostic Coverage (DC)		0 %
Indicators/operating means		
Operation indicator		LED green, statically lit Power on , short-circuit : LED green flashing (approx. 4 Hz)
Function indicator		LED yellow ON: sensor detects background
Electrical specifications		
Operating voltage	U _B	10 ... 30 V DC , class 2
No-load supply current	I ₀	< 10 mA
Protection class		III
Output		
Switching type		NO contact
Signal output		1 PNP output, short-circuit protected, reverse polarity protected, open collector
Switching voltage		max. 30 V DC
Switching current		max. 50 mA , resistive load
Voltage drop	U _d	≤ 1.5 V DC
Switching frequency	f	approx. 800 Hz
Response time		600 μs
Conformity		
Product standard		EN 60947-5-2
Approvals and certificates		
EAC conformity		TR CU 020/2011
UL approval		E87056 , cULus Recognized, Class 2 Power Source
CCC approval		CCC approval / marking not required for products rated ≤36 V
Ambient conditions		
Ambient temperature		-25 ... 60 °C (-13 ... 140 °F)
Storage temperature		-30 ... 70 °C (-22 ... 158 °F)
Mechanical specifications		
Housing width		7.5 mm
Housing height		26 mm
Housing depth		13.8 mm
Degree of protection		IP67
Connection		2 m fixed cable
Material		
Housing		PC/ABS and TPU
Optical face		glass
Cable		PUR
Mass		approx. 20 g
Cable length		2 m

Connection

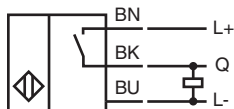

Release date: 2022-06-03 Date of issue: 2022-06-03 Filename: 269720_eng.pdf

Assembly

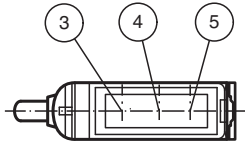
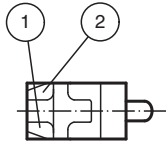

1	Operating display	green
2	Signal display	yellow
3	Emitter	
4	Receiver 1	
5	Receiver 2	

Characteristic Curve

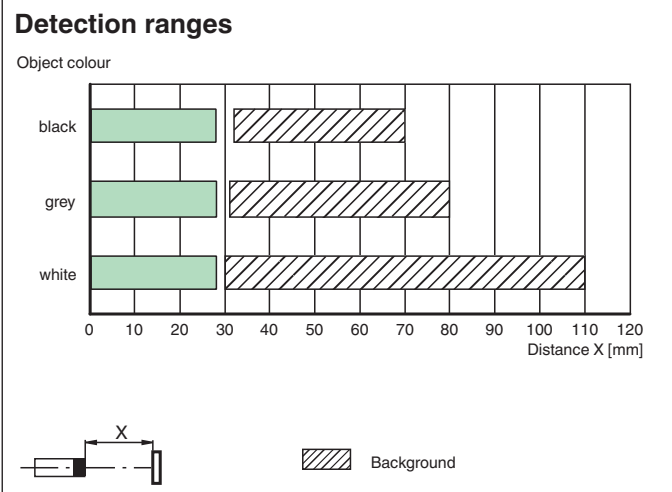
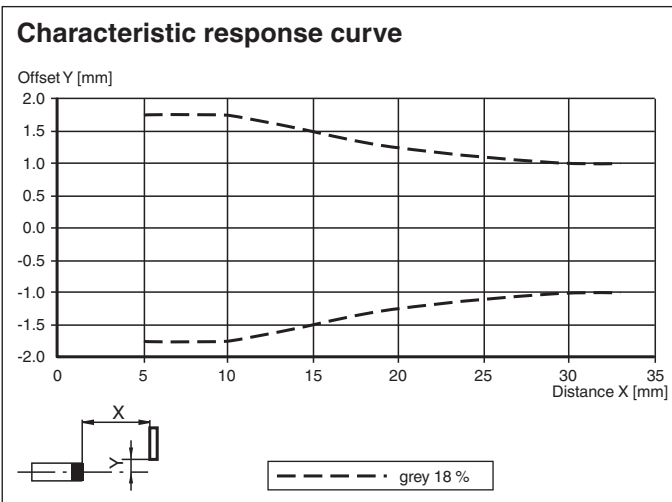

Accessories

	MH-R3-01	Mounting aid for sensors from the R3 series, mounting bracket
	MH-R3-02	Mounting aid for sensors from the R3 series, mounting bracket
	MH-R3-03	Mounting aid for sensors from the R3 series, mounting bracket
	MH-R3-04	Mounting aid for sensors from the R3 series, mounting bracket

Release date: 2022-06-03 Date of issue: 2022-06-03 Filename: 269720_eng.pdf