

9416 L

Connecteur, 12-broches, sens anti-horaire (numérotation des contacts en sens anti-horaire), sortie droite fabricant: Coninvers

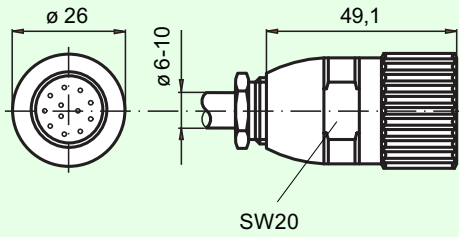

9426 C

Connecteur, 26-broches, sortie droite fabricant: Coninvers

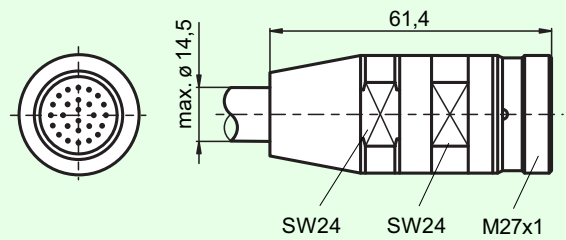

9420

Connecteur, 16-broches, sortie droite fabricant: Coninvers

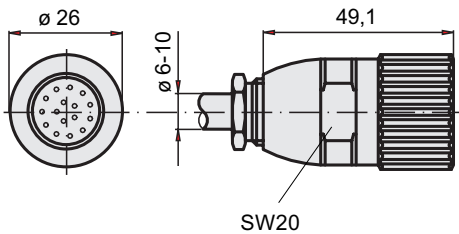

9426

Connecteur, 26-broches, sortie droite fabricant: Coninvers

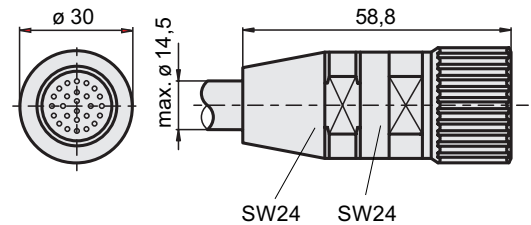

9423

Embase Sub-D, 25-broches, métal fabricant: FCT

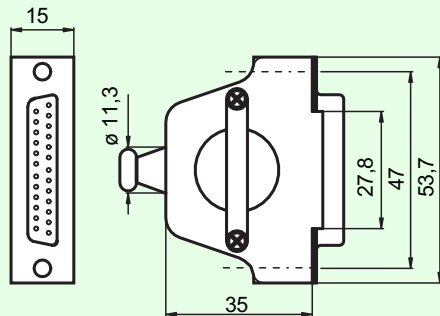

9428

Connecteur, 26-broches, sortie droite fabricant: Souriau

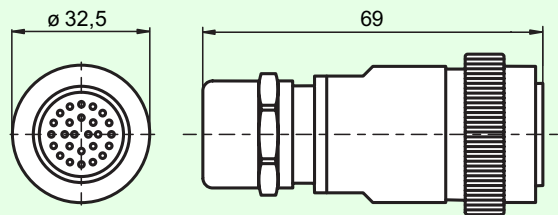

9424

Connecteur, 19-broches, sortie droite fabricant: Coninvers

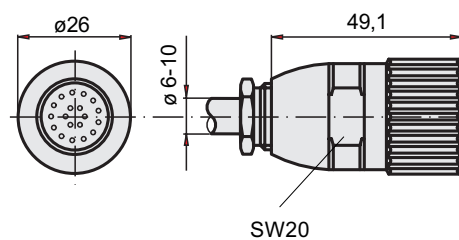

9429

Connecteur Sub-D, 9-broches, métal fabricant: FCT

