



Control Units Ex e, Stainless Steel

LCS*. *

- Stainless Steel enclosure
- Installation in Zone 1, Zone 2, Zone 21 and Zone 22
- Ex de, Ex ib and Ex tb certified
- Up to 4 operators per enclosure
- Customizable configuration of operators, cable entry quantities and cable gland types as per specification
- Wide range of labels and accessories available
- 3 enclosure size options
- Degree of protection IP66

Control Units Ex e, Stainless Steel



Function

The versatile control units of the LCS series are available as standard off-the-shelf control units or can be flexibly equipped with a great variety of operators, labels, cable glands and accessories. The comprehensive range of control functions allow the configuration of each control unit to exactly meet any application requirements and ensure optimal space efficiency.

The enclosures are manufactured from electropolished AISI 316L stainless steel to provide excellent tarnish and corrosion resistance. This surface finish is ideally suited to meet hygienic requirements valid in pharmaceutical and food processing plants. Durable materials and components of high quality allow the control units to be used in harsh ambient conditions.

Technical Data

Electrical specifications

Operating voltage	250 V max.
Operating current	16 A max.
Terminal capacity	2.5 mm ²
Terminal torque	0.8 Nm
Function	see data table

Mechanical specifications

Enclosure range	LCS
Enclosure cover	fully detachable
Cover fixing	stainless steel A4 (V4A) hexagonal head screws
Screws	M6
Number	4
Tightening torque	2 Nm
Degree of protection	IP66
Cable entry	cable glands as per specification
Number of cable entries	see data table
Defined entry area	face A and face B
Material	
Enclosure	1.5 mm AISI 316L, (1.4404) stainless steel
Finish	electropolished
Seal	one piece closed cell silicone
Mass	see data table
Dimensions	see data table
Tightening torque	
Nut torque at enclosure (SW1)	see datasheets of cable glands
Mounting	see data table
Grounding	M6 internal/external brass grounding bolt

Release date: 2022-05-12 Date of issue: 2022-05-12 Filename: t170323_eng.pdf

Refer to "General Notes Relating to Pepperl+Fuchs Product Information".

Pepperl+Fuchs Group
www.pepperl-fuchs.com

USA: +1 330 486 0002
pa-info@us.pepperl-fuchs.com

Germany: +49 621 776 2222
pa-info@de.pepperl-fuchs.com

Singapore: +65 6779 9091
pa-info@sg.pepperl-fuchs.com

PEPPERL+FUCHS

Technical Data

Ambient conditions	
Ambient temperature	-40 ... 55 °C (-40 ... 131 °F) -50 °C (-58 °F) on request
Data for application in connection with hazardous areas	
EU-type examination certificate	CML 16 ATEX 3009X
Marking	Ⓔ II 2 GD Ex db eb mb IIC T* Gb Ex ib IIC T* Gb Ex db eb ib mb IIC T* Gb Ex tb IIC T** °C Db T6/T80 °C @ Ta +40 °C T4/T130 °C @ Ta +55 °C
International approvals	
IECEX approval	IECEX CML 16.0008X
EAC approval	RU C-DE.BH02.B.00016/18
IA approval	MASC S/18-0003X
CCC approval	2020322304002545
Conformity	
Degree of protection	EN 60529
Usage category	IEC / EN 60947
CE marking	0080 or 0102, see type label
General information	
Ordering information	For standard configured units please see pdf data sheet. For configuration details please contact Customer Service.
Supplementary information	EC-Type Examination Certificate, Statement of Conformity, Declaration of Conformity, Attestation of Conformity and instructions have to be observed where applicable. For information see www.pepperl-fuchs.com .
Accessories	
Optional accessories	engraved traffolyte tag label engraved AISI 316L stainless steel tag label color in-fill stainless steel tag label M6 internal/external stainless steel grounding bolt
Indicators/operating means	
Control elements	small footprint max. 4 see data table all NC contacts have a direct opening action for emergency stop functions

Type Code

1	2	3	4	5	6	7	8	9
LC	*	*	****	****	****	****	*	*
LC	S	2	PGMX	E4MX			B	1

Example: LCS2.PGMX.E4MX.B.1

Control Unit, stainless steel enclosure for two control functions. Upper function: pushbutton green, base-mounted contact block with 1x NO / 1x NC contacts. Lower function: twist-to-release mushroom button, red, base-mounted contact block with 1x NO / 1x NC contacts. Cable entry configuration: bottom face cable gland M20 polyamide. Type of protection Ex db eb and Ex tb.

1	Series
LC	control unit
2	Material
S	stainless steel
3	Enclosure type / quantity of operating elements
1 ... 4	up to 4 operating elements, see dimensions data table
7	1 window for ammeter / voltmeter
8	1 window for ammeter / voltmeter and 1 operating element
9	1 window for ammeter / voltmeter and 2 operating elements
4	Function 1
xxxx	see operating elements type code
5	Function 2
xxxx	see operating elements type code

Release date: 2022-05-12 Date of issue: 2022-05-12 Filename: t170323_eng.pdf

Refer to "General Notes Relating to Pepperl+Fuchs Product Information".

Pepperl+Fuchs Group
www.pepperl-fuchs.com

USA: +1 330 486 0002
pa-info@us.pepperl-fuchs.com

Germany: +49 621 776 2222
pa-info@de.pepperl-fuchs.com

Singapore: +65 6779 9091
pa-info@sg.pepperl-fuchs.com

 **PEPPERL+FUCHS**

6	Function 3
xxxx	see operating elements type code
7	Function 4
xxxx	see operating elements type code
8	Entry configuration / cable glands
A ... M	standard entry configurations, see cable entries table
X	no entries
Z	customized entries
9	Type of explosion protection
	no character indicates Ex e (former versions)
1	Ex db eb mb, Ex tb
3	Ex ib, Ex tb
5	Ex db ib mb, Ex tb

Dimensions and Enclosure Details

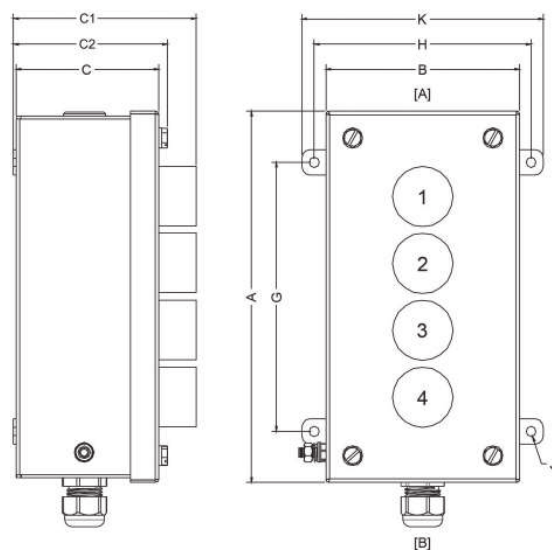

Enclosure type	Operating elements size and quantity	External dimensions [mm]						Mounting [mm]			Mass approx. [kg]
		A	B	C	C1	C2	K	G	H	J	
LCS1.*	1x small / 1x large	102	116	85.5	126	92.2	145	41	130	6.1	0.7
LCS2.*	2x small	142	116	85.5	100	92.2	145	81	130	6.1	1
LCS2.4P.*	1x small / 1x large (4pole)	142	116	85.5	126	92.2	145	81	130	6.1	1
LCS3.*	3x small / 3x large	220	116	85.5	115	92.2	145	161	130	6.1	1.5
LCS4.*	4x small	220	116	85.5	126	92.2	145	161	130	6.1	1.5
LCS7.*	1x ammeter or voltmeter	142	116	85.5	117	92.2	145	81	130	6.1	1.5
LCS8.*	1x ammeter and 1x small	220	116	85.5	117	92.2	145	161	130	6.1	1.5
LCS9.*	1x ammeter and 2x small	220	116	85.5	100	92.2	145	161	130	6.1	1.5

Dimension C1 is maximum, it will differ according to operating elements configuration

Cable Entries max. Quantity per Size

Type Code	Cable entries Face A			Cable entries Face B					
	M20 qty.	M20 type	M20 clamping range	M20 qty.	M20 type	M20 clamping range	M25 qty.	M25 type	M25 clamping range
.A.	-	-	-	1	CG.PEDS.M20.*	6 ... 12 mm	-	-	-
.B.	1	SP.PE.M20.*	-	1	CG.PEDS.M20.*	6 ... 12 mm	-	-	-
.F.	-	-	-	-	-	-	1	CG.PEDS.M25.*	10 ... 18 mm

Standard Variants

Type	Function	Color	Labeling	Operator action	Number of poles	Contact configuration	Switching configuration	Electrical specification	Switching diagram	Image example
LCS1.PRMX.*	pushbutton	red	0	spring return	2	1x NO / 1x NC	-	(1)		
LCS1.PGMX.*	pushbutton	green	I	spring return	2	1x NO / 1x NC	-	(1)		
LCS1.DMMX.*	double pushbutton	red / green	0 - I	spring return	2	1x NO / 1x NC	-	(1)		
LCS1.IRJX.*	illuminated pushbutton	red	-	spring return	1	1x NC	-	(2)		
LCS1.IGIX.*	illuminated pushbutton	green	-	spring return	1	1x NO	-	(2)		
LCS1.E4MZAR.*	mushroom button, with plastic lid	red	-	latching, twist to release	2	1x NO / 1x NC	-	(1)		
LCS1.E4MZPR.*	mushroom button, with plastic shroud, padlockable	red	-	latching, twist to release	2	1x NO / 1x NC	-	(1)		
LCS1.E4MX.*	mushroom button 40 mm	red	-	latching, twist to release	2	1x NO / 1x NC	-	(1)		
LCS1.E5MX.*	mushroom button 55 mm	red	-	latching, twist to release	2	1x NO / 1x NC	-	(1)		
LCS1.JRMX.*	mushroom button, lockable	red	-	latching, key release	2	1x NO / 1x NC	-	(1)		

Standard Variants

Type	Function	Color	Labeling	Operator action	Number of poles	Contact configuration	Switching configuration	Electrical specification	Switching diagram	Image example
LCS1. N1OX.*	control switch, small	black	0 - I	engage - engage	2	2x NO	2 position changeover with left OFF	(1)		
LCS1. N2MX.*	control switch, small	black	I - II	engage - engage	2	1x NO / 1x NC	2 position changeover	(1)		
LCS1. N3OX.*	control switch, small	black	I - 0 - II	engage - engage - engage	2	2x NO	3 position changeover with center OFF	(1)		
LCS1. S1OX.*	control switch, large, with shroud, padlockable in '0'	black	0 - I	engage - engage	2	2x NO	2 position changeover with left OFF	(1)		
LCS1. S2MX.*	control switch, large, with shroud	black	I - II	engage - engage	2	1x NO / 1x NC	2 position changeover	(1)		
LCS1. S3OX.*	control switch, large, with shroud, padlockable in '0'	black	I - 0 - II	engage - engage - engage	2	2x NO	3 position changeover with center OFF	(1)		
LCS1. K1OX.*	key switch	black / silver	0 - I	engage - engage	2	2x NO	2 position changeover with left OFF	(1)		
LCS1. K1MX.*	key switch	black / silver	0 - I	engage - engage	2	1x NO / 1x NC	2 position changeover with left OFF	(1)		
LCS1. K3OX.*	key switch	black / silver	I - 0 - II	engage - engage - engage	2	2x NO	3 position changeover with center OFF	(1)		
LCS1. LRLX.*	LED indicator	red	-	-	-	-	-	(3)		
LCS1. LGLX.*	LED indicator	green	-	-	-	-	-	(3)		

Release date: 2022-05-12 Date of issue: 2022-05-12 Filename: t170923_eng.pdf

Refer to "General Notes Relating to Pepperl+Fuchs Product Information".

Pepperl+Fuchs Group
www.pepperl-fuchs.com

USA: +1 330 486 0002
pa-info@us.pepperl-fuchs.com

Germany: +49 621 776 2222
pa-info@de.pepperl-fuchs.com

Singapore: +65 6779 9091
pa-info@sg.pepperl-fuchs.com

Standard Variants

Type	Function	Color	Labeling	Operator action	Number of poles	Contact configuration	Switching configuration	Electrical specification	Switching diagram	Image example
LCS2.4P. S201X.*	control switch, large, with shroud	black	I - II	engage - engage	4	2x NO / 2x NC	2 position changeover	(1)		
LCS2. PGMX. PRMX.*	pushbutton	green	I	spring return	2	1x NO / 1x NC	-	(1)		
	pushbutton	red	0	spring return	2	1x NO / 1x NC	-	(1)		
LCS2. PGMX. E4MX.*	pushbutton	green	I	spring return	2	1x NO / 1x NC	-	(1)		
	mushroom button	red	-	latching, twist to release	2	1x NO / 1x NC	-	(1)		
LCS2. PGMX. JRMX.*	pushbutton	green	I	spring return	2	1x NO / 1x NC	-	(1)		
	mushroom button, lockable	red	-	latching, key release	2	1x NO / 1x NC	-	(1)		
LCS3. PGMX. PRMX. E4MX.*	pushbutton	green	I	spring return	2	1x NO / 1x NC	-	(1)		
	pushbutton	red	0	spring return	2	1x NO / 1x NC	-	(1)		
	mushroom button	red	-	latching, twist to release	2	1x NO / 1x NC	-	(1)		
LCS3. LRLX. PGMX. PRMX.*	LED indicator	red	-	-	-	-	-	(3)		
	pushbutton	green	I	spring return	2	1x NO / 1x NC	-	(1)		
	pushbutton	red	0	spring return	2	1x NO / 1x NC	-	(1)		

Release date: 2022-05-12 Date of issue: 2022-05-12 Filename: t170923_eng.pdf

Refer to "General Notes Relating to Pepperl+Fuchs Product Information".





Standard Variants

Type	Function	Color	Labeling	Operator action	Number of poles	Contact configuration	Switching configuration	Electrical specification	Switching diagram	Image example
LCS3. LGLX. PGMX. PRMX.*	LED indicator	green	-	-	-	-	-	(3)		
	pushbutton	green	I	spring return	2	1x NO / 1x NC	-	(1)		
	pushbutton	red	O	spring return	2	1x NO / 1x NC	-	(1)		
LCS3. LRLX. DMMX. JRMX.*	LED indicator	red	-	-	-	-	-	(3)		
	double pushbutton	red / green	0 - I	spring return	2	1x NO / 1x NC	-	(1)		
	mushroom button, lockable	red	-	latching, key release	2	1x NO / 1x NC	-	(1)		
LCS3. LRLX. LOLX. LGLX.*	LED indicator	red	-	-	-	-	-	(3)		
	LED indicator	amber	-	-	-	-	-	(3)		
	LED indicator	green	-	-	-	-	-	(3)		
LCS7. WBAASA.*	ammeter 1 A	-	scale 0 ... 1 / 5 A	-	-	-	-	(4)		
LCS8. WBAASA. N5MX.*	ammeter 1 A	-	scale 0 ... 1 / 5 A	-	-	-	-	(4)		
	control switch, small	black	0 - I - II	engage - engage - engage	2	1x NO / 1x NC	3 position changeover with left OFF	(1)		

Release date: 2022-05-12 Date of issue: 2022-05-12 Filename: t170923_eng.pdf

Refer to "General Notes Relating to Pepperl+Fuchs Product Information".

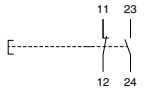
Standard Variants

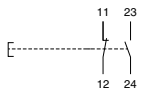
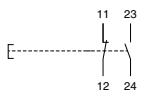
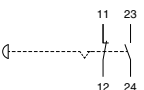
Type	Function	Color	Labeling	Operator action	Number of poles	Contact configuration	Switching configuration	Electrical specification	Switching diagram	Image example
LCS9. WBAASA. PGMX. PRMX.*	ammeter 1 A	-	scale 0 ... 1 / 5 A	-	-	-	-	(4)		
	pushbutton	green	I	spring return	2	1x NO / 1x NC	-	(1)		
	pushbutton	red	O	spring return	2	1x NO / 1x NC	-	(1)		
LCS4. LRLX. PGMX. PRMX. E4MX.*	LED indicator	red	-	-	-	-	-	(3)		
	pushbutton	green	I	spring return	2	1x NO / 1x NC	-	(1)		
	pushbutton	red	O	spring return	2	1x NO / 1x NC	-	(1)		
	mushroom button	red	-	latching, twist to release	2	1x NO / 1x NC	-	(1)		

Electrical Specifications

Reference in standard variants	Usage category	Rated operating voltage	Rated operating current
(1)	AC12 - 12 ... 250 V AC - 16 A AC15 - 12 ... 250 V AC - 10 A DC13 - 12 ... 110 V DC - 1 A DC13 - 12 ... 24 V DC - 1 A	-	-
(2)	AC15 - 12 ... 250 V AC - 10 A DC13 - 12 ... 24 V DC - 1 A	-	-
(3)	-	12 ... 250 V AC 12 ... 24 V DC	-
(4)	-	690 V AC	1 A

Configurations - Types of Operating Elements see Overleaf

Configurations with 1 function

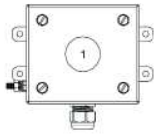

LCS1.*

maximum configuration (1)

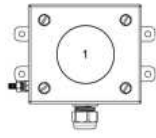

LCS1.*

large operator 2 pole (2)

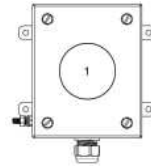

LCS2.4P.*

large operator 4 pole (3)

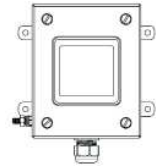

LCS7.*

window (4)

Configurations with 2 functions

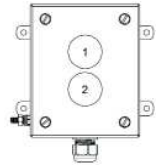

LCS2.*

maximum configuration (1)

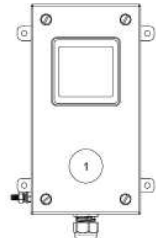

LCS8.*

window + 1 small operator (4)

Configurations with 3 functions

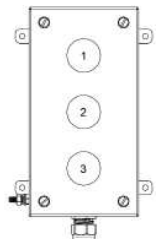

LCS3.*

maximum configuration (1)

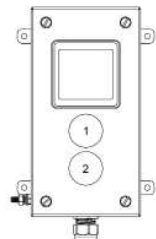

LCS3.*

large operator 2 pole (2)

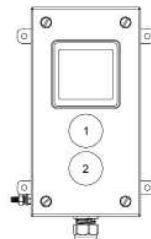

LCS9.*

window + 2 small operators (4)

Configurations with 4 functions

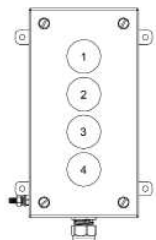

LCS4.*

maximum configuration (1)























- (1) Small operators with 2 pole contact blocks
Small operators include all pushbuttons, small switching actuators, LED indicators and potentiometers
- (2) Large switching actuators and all operators fitted with 2 pole contact modules, protective lid or padlockable shroud
- (3) Small and large switching actuators and all operators fitted with 4 pole contact modules, protective lid or padlockable shroud
- (4) Viewing windows with ammeter or voltmeter in combination with operating elements

Note: the use of label holders depends on operator configuration

All NC contacts have a direct opening action for emergency stop functions

For further configurations please contact Pepperl+Fuchs

Pushbuttons and Emergency Stops

Pushbuttons Actuator Heads			
Type	Color	Labeling	Image
CFP.PA	red	none	
CFP.PR	red	0	
CFP.PC	red	STOP	
CFP.PD	red	OFF	
CFP.PE	green	none	
CFP.PG	green	I	
CFP.PI	green	II	
CFP.PF	green	START	
CFP.PH	green	ON	
CFP.PY	yellow	none	
CFP.PO	amber	none	
CFP.PW	white	none	
CFP.PB	blue	none	
CFP.PJ	blue	RESET	
CFP.PK	black	none	
CFP.PL	black	0	
CFP.PN	black	I	
CFP.PP	black	II	
CFP.PQ	black	III	
CFP.PT	black	IV	
CFP.PU	black	arrow up	
CFP.PV	black	arrow down	
CFP.PZ*	see individual datasheets		

Actuator Heads - Technical Data

Mechanical specifications	
Dimensions	see data table
Mounting	use with base-mounted and lid-mounted contact modules
Degree of protection	IP66
Mass	see data table
Material	
Housing	Polyamide (PA)
Finish	inherent color black
Washer gasket	silicone
Ambient conditions	
Ambient temperature	-40 ... 55 °C (-40 ... 131 °F)
Service temperature	-40 ... 65 °C (-40 ... 149 °F)
Data for application in connection with hazardous areas	
EU-Type Examination Certificate	CML 16 ATEX 3339U
Marking	 II 2 GD Ex e IIC Gb Ex tb IIIC Db
International approvals	
IECEX approval	IECEX CML 16.0114U
Conformity	
Degree of protection	EN 60529
CE marking	0102
General information	
Supplementary information	EC-Type Examination Certificate, Statement of Conformity, Declaration of Conformity, Attestation of Conformity and instructions have to be observed where applicable. For information see www.pepperl-fuchs.com .
Enclosure type	LC*, LR* FXL*.CS, SR.CS* GR.CS*

Pushbuttons and Emergency Stops

Emergency Stops Actuator Heads

Type	Function	Color	Labeling	Operator action	Actuator head diameter	Switching diagram	Image
CFP.E4	mushroom button	red	none	latching, twist to release	40 mm		
CFP.E5	mushroom button	red	none	latching, twist to release	55 mm		
CFP.JR	mushroom button	red	none	latching, key release	39 mm		

Other Pushbuttons Actuator Heads

Type	Function	Color	Labeling	Operator action	Actuator head diameter	Switching diagram	Image
CFP.DM	pushbutton	red / green	0 - I	spring return	70 mm x 39 mm		
CFP.MK	mushroom button	black	none	spring return	39 mm		
CFP.MR	mushroom button	red	none	spring return	39 mm		
CFP.MG	mushroom button	green	none	spring return	39 mm		

Pushbuttons and Emergency Stops

Pushbuttons and Emergency Stops - Dimensions

Type	Function	Actuator head diameter [mm]	Panel wall thickness [mm]	Diameter thru-hole [mm]	Length outside enclosure [mm]	Total length [mm]	Mass [g]
		D2	PT	DT	H	L	
CFP.P*	pushbutton	39	1 ... 6	30.6	15.5	35.4	25
CFP.DM*	double pushbutton	70 x 39	1 ... 6	30.6	15.5	35.4	38
CFP.E4	emergency stop	40	1 ... 6	30.6	41.8	62.1	52
CFP.E5	emergency stop	55	1 ... 6	30.6	41.8	62.1	58
CFP.JR	key release mushroom button	39	1 ... 6	30.6	49.5	70	65
CFP.M*	mushroom button	37	1 ... 6	30.6	41.2	60.7	46

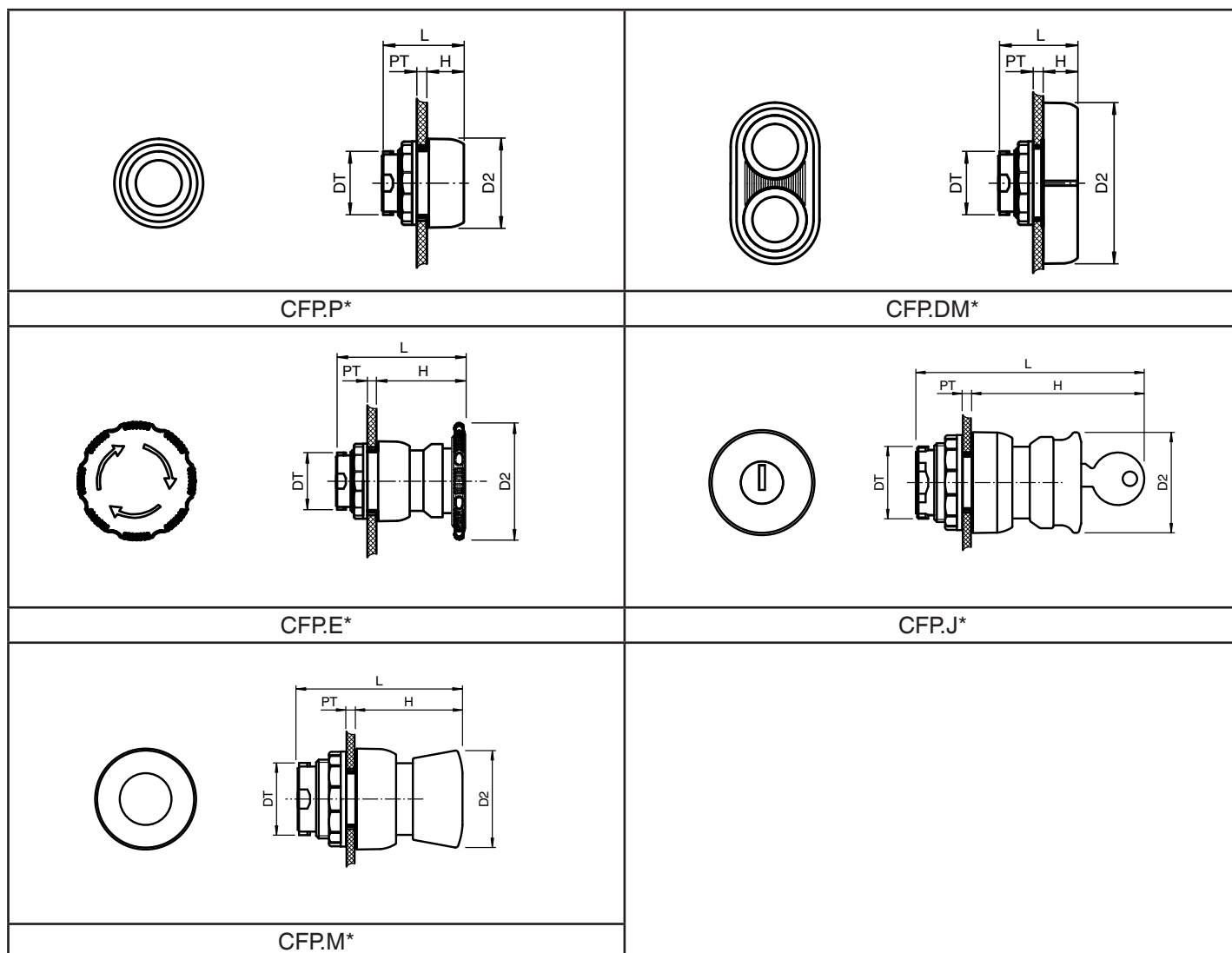

Pushbuttons and Emergency Stops

Contact Blocks

Type	Mounting	Number of poles	Contact configuration	Switching diagram see overview	Image
CFPM	base-mounted	2	1x NO / 1x NC		
CFPC	base-mounted	2	2x NC		
CFPO	base-mounted	2	2x NO		

Contact Blocks - Technical Data

Electrical specifications

Operating voltage	250 V max.
Operating current	16 A max.
Terminal capacity	2.5 mm ²
Terminal torque	0.8 Nm
Usage category	AC12: 12 ... 250 V AC - 16 A AC15: 12 ... 250 V AC - 10 A DC13: 12 ... 110 V DC - 1 A DC13: 12 ... 24 V DC - 1 A

Mechanical specifications

Mechanical life	1000000 switching operations
Degree of protection	IP20

Material

Housing	Polyamide (PA)
---------	----------------

Ambient conditions

Service temperature	-40 ... 90 °C (-40 ... 194 °F)
---------------------	--------------------------------

Data for application in connection with hazardous areas

EU-Type Examination Certificate	CML 16 ATEX 3339U
---------------------------------	-------------------

Marking	II 2 G Ex de IIC Gb
---------	------------------------

Contact Blocks - Technical Data continued

International approvals

IECEx approval	IECEx CML 16.0114U
----------------	--------------------

Conformity

Degree of protection	EN 60529
Usage category	IEC / EN 60947
CE marking	0102

General information

Supplementary information	EC-Type Examination Certificate, Statement of Conformity, Declaration of Conformity, Attestation of Conformity and instructions have to be observed where applicable. For information see www.pepperl-fuchs.com .
---------------------------	--

Pushbuttons and Emergency Stops



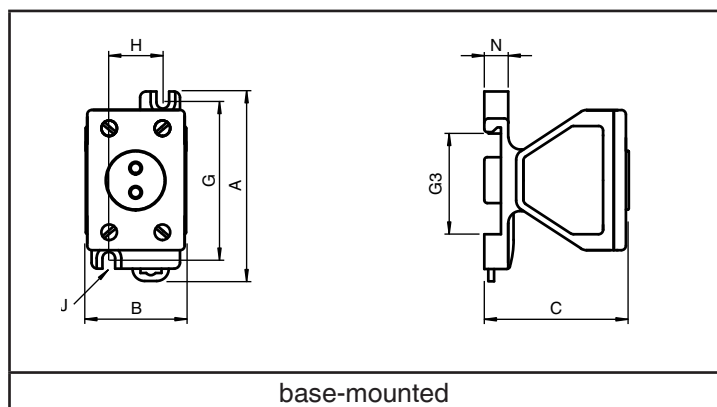

Contact Blocks - Dimensions

Mounting	External dimension [mm]			Mounting holes [mm]			Mounting brackets [mm]	DIN mounting rail receptacle [mm]	Mass [g]	Enclosure type
	A	B	C	G	H	Diam. J	N	G3		
base-mounted	63	33.4	50	52	18	4.2	8	35.6	68	LC*, LR* GR.CS*



Illuminated Pushbuttons

Illuminated Pushbuttons Actuator Heads

Type	Lens color	Operator action	Switching diagram	Image
CFP.IR	red	spring return	E-----	
CFP.IG	green	spring return	E-----	
CFP.IO	amber	spring return	E-----	
CFP.IW	white	spring return	E-----	
CFP.IB	blue	spring return	E-----	

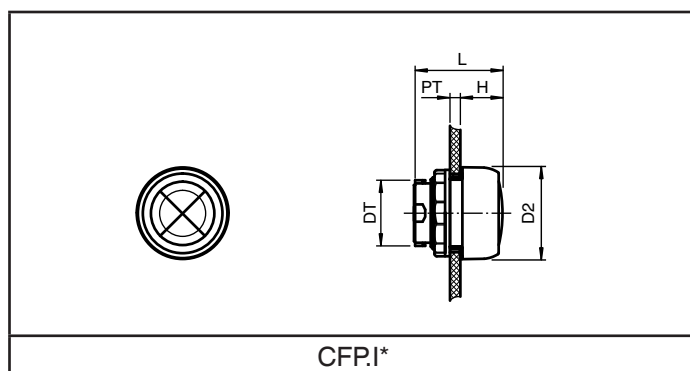

Actuator Heads - Technical Data

Mechanical specifications	
Degree of protection	IP66
Material	
Housing	Polyamide (PA)
Finish	inherent color black
Washer gasket	silicone
Ambient conditions	
Ambient temperature	-40 ... 55 °C (-40 ... 131 °F)
Service temperature	-40 ... 65 °C (-40 ... 149 °F)
Data for application in connection with hazardous areas	
EU-Type Examination Certificate	CML 16 ATEX 3339U
Marking	 II 2 GD Ex e IIC Gb Ex tb IIIC Db
International approvals	
IECEX approval	IECEX CML 16.0114U
Conformity	
Degree of protection	EN 60529
CE marking	0102
General information	
Supplementary information	EC-Type Examination Certificate, Statement of Conformity, Declaration of Conformity, Attestation of Conformity and instructions have to be observed where applicable. For information see www.pepperl-fuchs.com .

Illuminated Pushbuttons Actuator Heads - Dimensions

Actuator head diameter [mm]	Panel wall thickness [mm]	Diameter thru-hole [mm]	Length outside enclosure [mm]	Total length [mm]	Mass [g]	Mounting	Enclosure type
D2	PT	DT	H	L			
39	1 ... 6	30.6	17.5	36.8	21	use with base-mounted and cover-mounted contact modules	LC*, LR* FXL*.CS GR.CS*

Illuminated Pushbuttons

LED Contact Modules

Type	Mounting	Operating voltage [V]	Number of poles	Contact configuration	Switching diagram	Image
CFP.IL	base-mounted	10 ... 28 V AC/DC	1	1x NO		
CFP.I	base-mounted	30 ... 250 V AC	1	1x NO		
CFP.II	base-mounted	10 ... 28 V AC/DC Ex ia	1	1x NO		
CFP.JL	base-mounted	10 ... 28 V AC/DC	1	1x NC		
CFP.J	base-mounted	30 ... 250 V AC	1	1x NC		
CFP.JI	base-mounted	10 ... 28 V AC/DC Ex ia	1	1x NC		

Illuminated Pushbuttons

LED Contact Modules - Dimensions

Mounting	External dimension [mm]				Mounting holes [mm]			Mounting brackets [mm]	DIN rail receptacle [mm]	Mass [g]	Enclosure type
	A	B	C	L	G	H	Diam. J	N	G3		
base-mounted	63	33.4	47	82	52	18	4.2	8	35.6	72	LC*, LR* GR.CS*

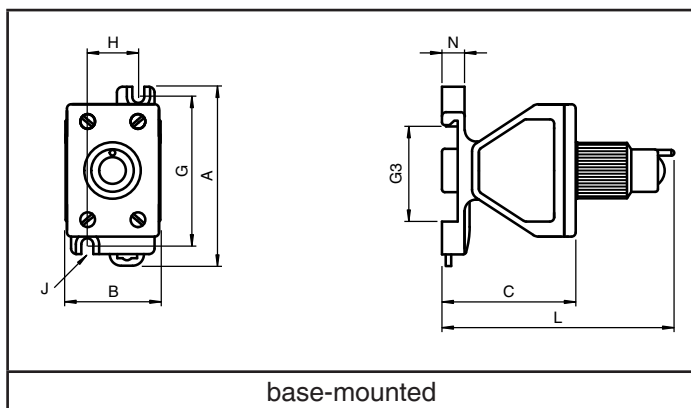

LED Modules - Technical Data

Electrical specifications

Operating voltage	250 V max.
Operating current	10 A max.
Power consumption	1 W max.
Terminal capacity	2.5 mm ²
Terminal torque	0.8 Nm
Usage category	AC15: 10 ... 250 V AC - 10 A DC13: 10 ... 24 V DC - 1 A

Mechanical specifications

Mechanical life	1000000 switching operations
Degree of protection	IP20

Material

Housing	Polyamide (PA)
---------	----------------

Ambient conditions

Service temperature	-55 ... 90 °C (-67 ... 194 °F)
---------------------	--------------------------------

Data for application in connection with hazardous areas

EU-Type Examination Certificate	CML 16 ATEX 3339U
Marking	Ex II 2 G Ex de IIC Gb

Intrinsically safe variants

Marking	Ex II 1 G Ex ia IIC Ga
---------	---------------------------

Voltage U _i	28 V
Current I _i	93 mA
Power P _i	0.651 W
Internal capacitance C _i	0 µF
Internal inductance L _i	0 mH

International approvals

IECEX approval	IECEX CML 16.0114U
----------------	--------------------

Conformity

Degree of protection	EN 60529
Usage category	IEC / EN 60947-3
CE marking	0102

LED Modules - Technical Data

General information

Supplementary information

EC-Type Examination Certificate, Statement of Conformity, Declaration of Conformity, Attestation of Conformity and instructions have to be observed where applicable. For information see www.pepperl-fuchs.com.

Control Switches Actuator Heads, for use with LCP*, LCS* and LR*

Control Switch Actuator Heads								
Type	Function	Diameter [mm]	Switching configuration	Switching diagram	Operator action	Labeling	Lockable	Image
CFP.N1	rotary actuator	39	2 position changeover with left OFF		L - L	0 - I	-	
CFP.N2	rotary actuator	39	2 position changeover		L - L	I - II	-	
CFP.N3	rotary actuator	39	3 position changeover with center OFF		L - L - L	I - 0 - II	-	
CFP.N3S	rotary actuator	39	3 position changeover with center OFF		S - L - S	I - 0 - II	-	
CFP.N5	rotary actuator	39	3 position changeover with left OFF		L - L - L	0 - I - II	-	
CFP.S1	rotary actuator	60	2 position changeover with left OFF		L - L	0 - I	yes	
CFP.S2	rotary actuator	60	2 position changeover		L - L	I - II	yes	
CFP.S3	rotary actuator	60	3 position changeover with center OFF		L - L - L	I - 0 - II	yes	
CFP.S3S	rotary actuator	60	3 position changeover with center OFF		S - L - S	I - 0 - II	yes	
CFP.S5	rotary actuator	60	3 position changeover with left OFF		L - L - L	0 - I - II	yes	
CFP.K1	key switch rotary actuator	39	2 position changeover with left OFF		L - L	0 - I	yes	
CFP.K1S	key switch rotary actuator	39	2 position changeover with left OFF		L - S	0 - I	yes	
CFP.K3	key switch rotary actuator	39	3 position changeover with center OFF		L - L - L	I - 0 - II	yes	
CFP.K3S	key switch rotary actuator	39	3 position changeover with center OFF		S - L - S	I - 0 - II	yes	

Operator action: L = latching, S = spring return

Control Switches Actuator Heads

Actuator Heads - Dimensions

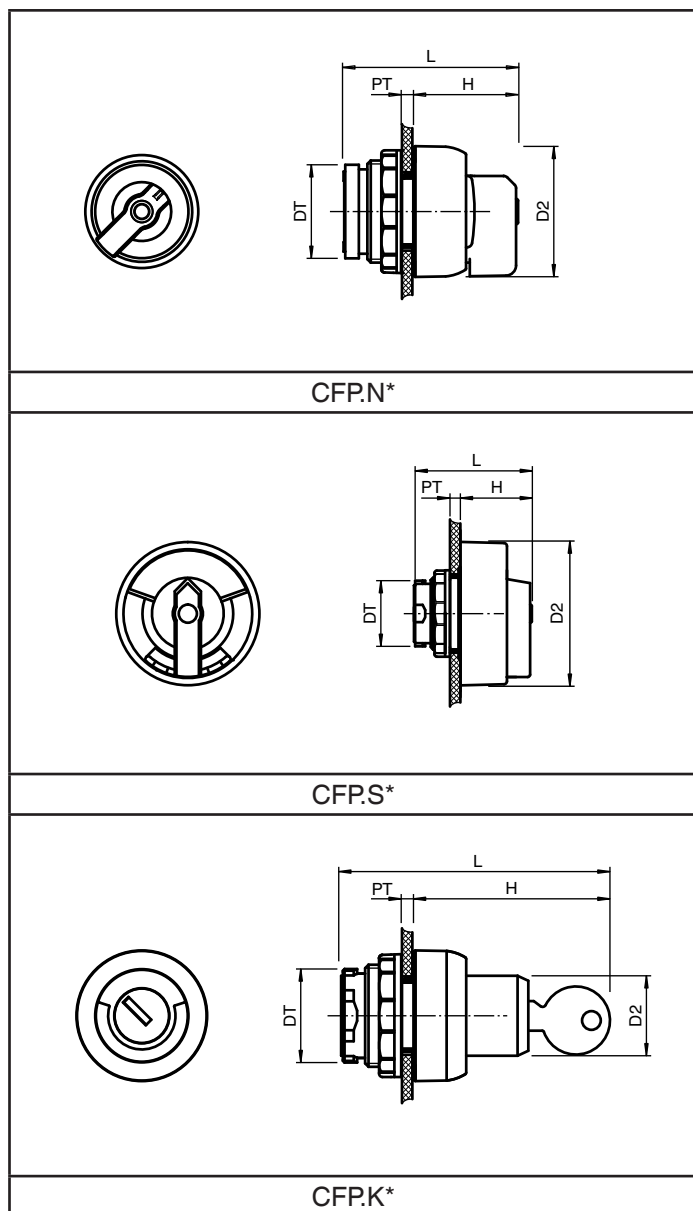

Actuator Heads - Technical Data

Mechanical specifications

Dimensions	see data table
Mounting	use with base-mounted and lid-mounted contact modules
Degree of protection	IP66
Mass	see data table

Material

Housing	Polyamide (PA)
Finish	inherent color black
Washer gasket	silicone

Ambient conditions

Ambient temperature	-40 ... 55 °C (-40 ... 131 °F)
Service temperature	-40 ... 65 °C (-40 ... 149 °F)

Data for application in connection with hazardous areas

EU-Type Examination Certificate	CML 16 ATEX 3339U
Marking	 II 2 GD Ex e IIC Gb Ex tb IIIC Db

International approvals



IECEX approval	IECEX CML 16.0114U
----------------	--------------------

Conformity

Degree of protection	EN 60529
CE marking	0102

General information

Supplementary information	EC-Type Examination Certificate, Statement of Conformity, Declaration of Conformity, Attestation of Conformity and instructions have to be observed where applicable. For information see www.pepperl-fuchs.com .
---------------------------	--

Type	Actuator head diameter [mm]	Panel wall thickness [mm]	Diameter thru-hole [mm]	Length outside enclosure [mm]	Total length [mm]	Mass [g]	Image example
	D2	PT	DT	H	L		
CFP.N*	39	1 ... 6	30.6	30.5	50.5	30	
CFP.S*	60	1 ... 6	30.6	30.5	50.5	46	
CFP.K*	39	1 ... 6	30.6	49.5	70	46	

Refer to "General Notes Relating to Pepperl+Fuchs Product Information".

Pepperl+Fuchs Group
www.pepperl-fuchs.comUSA: +1 330 486 0002
pa-info@us.pepperl-fuchs.comGermany: +49 621 776 2222
pa-info@de.pepperl-fuchs.comSingapore: +65 6779 9091
pa-info@sg.pepperl-fuchs.com PEPPERL+FUCHS

Control Switches, 2 Pole Contact Blocks, for use with LCP*, LCS* and LR*

Combination of 2 Pole Contact Blocks and Actuator Heads

Actuator head function	Actuator head diameter [mm]	Switching configuration	Contact block	Contacts	Switching diagram see overview	Operator action	Labeling	Lockable	Actuator type
rotary actuator	39	2 position changeover with left OFF	O	2x NO	(1)	L - L	0 - I	-	N1
rotary actuator	39	2 position changeover	M	1x NO / 1x NC	(2)	L - L	I - II	-	N2
rotary actuator	39	3 position changeover with center OFF	O	2x NO	(4)	L - L - L	I - 0 - II	-	N3
rotary actuator	39	3 position changeover with center OFF	O	2x NO	(4)	S - L - S	I - 0 - II	-	N3S
rotary actuator	39	3 position changeover with left OFF	M	1x NO / 1x NC	(3)	L - L - L	0 - I - II	-	N5
rotary actuator	60	2 position changeover with left OFF	O	2x NO	(1)	L - L	0 - I	yes	S1
rotary actuator	60	2 position changeover	M	1x NO / 1x NC	(2)	L - L	I - II	-	S2
rotary actuator	60	3 position changeover with center OFF	O	2x NO	(4)	L - L - L	I - 0 - II	yes	S3
rotary actuator	60	3 position changeover with center OFF	O	2x NO	(4)	S - L - S	I - 0 - II	yes	S3S
rotary actuator	60	3 position changeover with left OFF	M	1x NO / 1x NC	(3)	L - L - L	0 - I - II	yes	S5
key switch rotary actuator	39	2 position changeover with left OFF	O	2x NO	(1)	L - L	0 - I	yes	K1
key switch rotary actuator	39	2 position changeover with left OFF	O	2x NO	(1)	L - S	0 - I	yes	K1S
key switch rotary actuator	39	3 position changeover with center OFF	O	2x NO	(4)	L - L - L	I - 0 - II	yes	K3
key switch rotary actuator	39	3 position changeover with center OFF	O	2x NO	(4)	S - L - S	I - 0 - II	yes	K3S

Operator action: L = latching, S = spring return

Contact Blocks

Type	Mounting	Number of poles	Contact configuration	Switching diagram	Image
CFPM	base-mounted	2	1x NO / 1x NC		
CFPC	base-mounted	2	2x NC		
CFPO	base-mounted	2	2x NO		

Refer to "General Notes Relating to Pepperl+Fuchs Product Information".

Pepperl+Fuchs Group
www.pepperl-fuchs.comUSA: +1 330 486 0002
pa-info@us.pepperl-fuchs.comGermany: +49 621 776 2222
pa-info@de.pepperl-fuchs.comSingapore: +65 6779 9091
pa-info@sg.pepperl-fuchs.com

PEPPERL+FUCHS

Control Switches, 2 Pole Contact Blocks, for use with LCP*, LCS* and LR*

Switching Diagrams

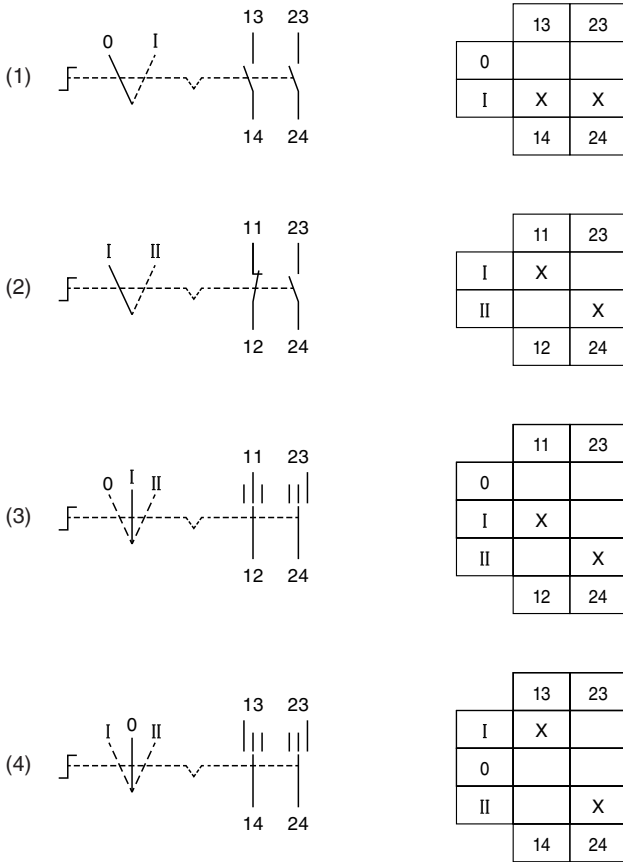

Contact Blocks - Technical Data

Electrical specifications

Operating voltage	250 V max.
Operating current	16 A max.
Terminal capacity	2.5 mm ²
Terminal torque	0.8 Nm
Usage category	AC12: 12 ... 250 V AC - 16 A AC15: 12 ... 250 V AC - 10 A DC13: 12 ... 110 V DC - 1 A DC13: 12 ... 24 V DC - 1 A

Mechanical specifications

Mechanical life	1000000 switching operations
Degree of protection	IP20

Material

Housing	Polyamide (PA)
---------	----------------

Ambient conditions

Service temperature	-40 ... 90 °C (-40 ... 194 °F)
---------------------	--------------------------------

Data for application in connection with hazardous areas

EU-Type Examination Certificate	CML 16 ATEX 3339U
---------------------------------	-------------------

Marking	II 2 G Ex de IIC Gb
---------	------------------------

International approvals

IECEx approval	IECEx CML 16.0114U
----------------	--------------------

Conformity

Degree of protection	EN 60529
Usage category	IEC / EN 60947
CE marking	0102

General information

Supplementary information	EC-Type Examination Certificate, Statement of Conformity, Declaration of Conformity, Attestation of Conformity and instructions have to be observed where applicable. For information see www.pepperl-fuchs.com .
---------------------------	--

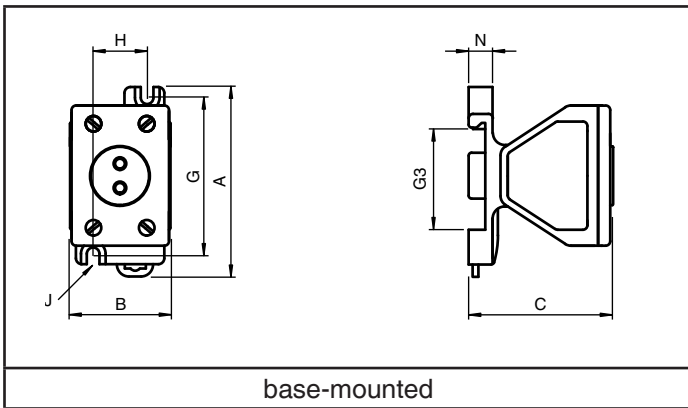

Contact Blocks - Dimensions

Mounting	External dimension [mm]			Mounting holes [mm]			Mounting brackets [mm]	DIN mounting rail receptacle [mm]	Mass [g]	Enclosure type
	A	B	C	G	H	Diam. J				
base-mounted	63	33.4	50	52	18	4.2	8	35.6	68	LC*, LR*

Release date: 2022-05-12 Date of issue: 2022-05-12 Filename: t170923_eng.pdf

Refer to "General Notes Relating to Pepperl+Fuchs Product Information".

Control Switches, 4 Pole Contact Blocks, for use with LCP*, LCS* and LR*

Combination of 4 Pole Contact Blocks and Actuator Heads

Actuator head function	Actuator head diameter [mm]	Switching configuration	Contact block	Contacts	Switching diagram see overview	Operator action	Labeling	Lockable	Actuator type
rotary actuator	60	2 position changeover with left OFF	03	4x NO	(5)	L - L	0 - I	yes	S1
rotary actuator	60	2 position changeover	01	2x NO / 2x NC	(6)	L - L	I - II	-	S2
rotary actuator	60	3 position changeover with center OFF	03	4x NO	(7)	L - L - L	I - 0 - II	yes	S3
rotary actuator	60	3 position changeover with center OFF	03	4x NO	(7)	S - L - S	I - 0 - II	yes	S3S

Operator action: L = latching, S = spring return

Contact Blocks

Type	Mounting	Number of poles	Contact configuration	Switching diagram	Image
CFP.01	base-mounted	4	2x NO / 2x NC		
CFP.02	base-mounted	4	4x NC		
CFP.03	base-mounted	4	4x NO		
CFP.04	base-mounted	4	1x NO / 3x NC		
CFP.05	base-mounted	4	3x NO / 1x NC		

Control Switches, 4 Pole Contact Blocks, for use with LCP*, LCS* and LR*

Switching Diagrams

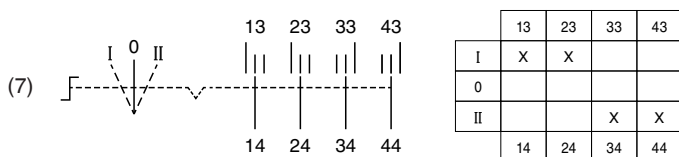
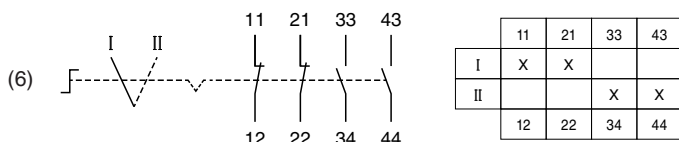
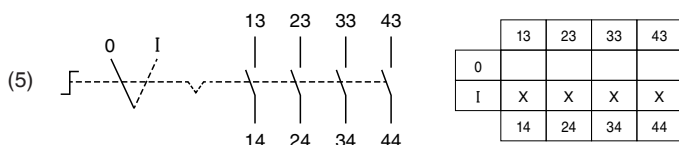

Contact Blocks - Technical Data

Electrical specifications

Operating voltage	250 V max.
Operating current	16 A max.
Terminal capacity	2.5 mm ²
Terminal torque	0.8 Nm
Usage category	AC12: 12 ... 250 V AC - 16 A AC15: 12 ... 250 V AC - 10 A DC13: 12 ... 110 V DC - 1 A DC13: 12 ... 24 V DC - 1 A

Mechanical specifications

Mechanical life	1000000 switching operations
Degree of protection	IP20

Material

Housing	Polyamide (PA)
---------	----------------

Ambient conditions

Service temperature	-40 ... 90 °C (-40 ... 194 °F)
---------------------	--------------------------------

Data for application in connection with hazardous areas

EU-Type Examination Certificate	CML 16 ATEX 3339U
Marking	II 2 G Ex de IIC Gb

International approvals

IECEx approval	IECEx CML 16.0114U
----------------	--------------------

Conformity

Degree of protection	EN 60529
Usage category	IEC / EN 60947
CE marking	0102

General information

Supplementary information	EC-Type Examination Certificate, Statement of Conformity, Declaration of Conformity, Attestation of Conformity and instructions have to be observed where applicable. For information see www.pepperl-fuchs.com .
---------------------------	--

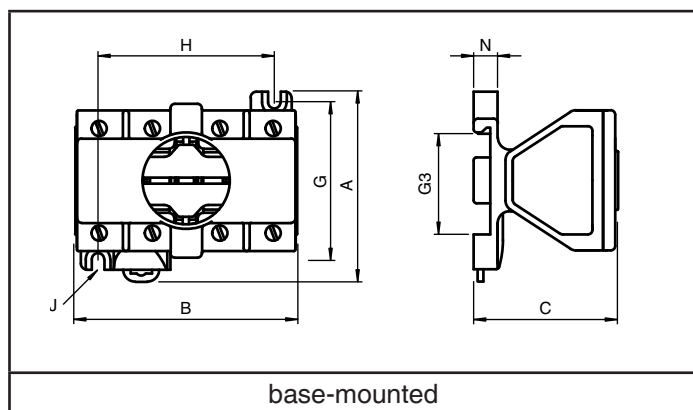

Contact Blocks - Dimensions

Mounting	External dimension [mm]			Mounting holes [mm]			Mounting brackets [mm]	DIN mounting rail receptacle [mm]	Mass [g]	Enclosure type
	A	B	C	G	H	Diam. J				
base-mounted	63	74	58.6	52	58	4.2	8	35.6	165	LC*, LR*

Release date: 2022-05-12 Date of issue: 2022-05-12 Filename: t170923_eng.pdf

Control Switches, 4 Pole Rotary Switching Blocks, for use with LCP*, LCS* and LR*

Combination of 4 Pole Rotary Switching Blocks and Actuator Heads							
Switching configuration	Switching block	Contacts	Switching diagram see overview	Operator action	Labeling	Lockable	Actuator type
2 position changeover, left OFF	10	4x NO	(10)	L - L	0 - I	yes	T1
2 position changeover	11	2x NO / 2x NC	(11)	L - L	I - II	-	T2
2 position changeover	17	3x NO / 1x NC	(17)	L - L	I - II	-	T2
2 position changeover	18	1x NO / 3x NC	(18)	L - L	I - II	-	T2
3 position changeover, center OFF	12	4x NO	(12)	L - L - L	I - 0 - II	yes	T3
3 position changeover, center OFF	14	4x NO	(14)	L - L - L	I - 0 - II	yes	T3
3 position changeover, center OFF, both sides spring return	13	4x NO	(13)	S - L - S	I - 0 - II	yes	T3
3 position changeover	22	4x NO	(22)	L - L - L	I - 0 - II	-	T3
3 position changeover	23	4x NO	(23)	L - L - L	0 - I - II	-	T5
3 position changeover, right spring return	19	2x NO / 2x NC	(19)	L - L - S	0 - I - II	-	T5
3 position changeover, right spring return	16	3x NO / 1x NC	(16)	L - L - S	0 - I - II	-	T5
4 position changeover	15	3x NO / 1x NC	(15)	L - L - L - L	I - II - III - IV	-	T4
4 position changeover, right spring return	20	4x NO	(20)	L - L - L - S	I - II - III - IV	-	T4
4 position changeover	21	4x NO	(21)	L - L - L - L	I - II - III - IV	-	T4

Operator action: L = latching, S = spring return

Control Switches, 4 Pole Rotary Switching Blocks, for use with LCP*, LCS* and LR*

Dimensions



actuator head



rotary switching block, base-mounted

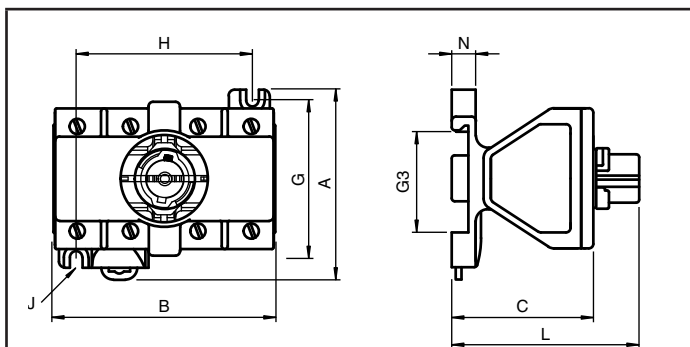

dimensions

Switching Blocks - Technical Data

Electrical specifications

Operating voltage	250 V max.
Operating current	16 A max.
Terminal capacity	2.5 mm ²
Terminal torque	0.8 Nm
Usage category	AC12: 12 ... 250 V AC - 16 A AC15: 12 ... 250 V AC - 10 A DC13: 12 ... 110 V DC - 1 A DC13: 12 ... 24 V DC - 1 A

Mechanical specifications

Mechanical life	1000000 switching operations
Degree of protection	IP20

Material

Housing	Polyamide (PA)
---------	----------------

Ambient conditions

Service temperature	-40 ... 90 °C (-40 ... 194 °F)
---------------------	--------------------------------

Data for application in connection with hazardous areas

EU-Type Examination Certificate	CML 16 ATEX 3339U
Marking	II 2 G Ex de IIC Gb

International approvals

IECEx approval	IECEx CML 16.0114U
----------------	--------------------

Conformity

Degree of protection	EN 60529
Usage category	IEC / EN 60947
CE marking	0102

General information

Supplementary information	EC-Type Examination Certificate, Statement of Conformity, Declaration of Conformity, Attestation of Conformity and instructions have to be observed where applicable. For information see www.pepperl-fuchs.com .
---------------------------	--

Switching Blocks - Dimensions

Mounting	External dimension [mm]			Mounting holes [mm]			Mounting brackets [mm]	DIN mounting rail receptacle [mm]	Mass [g]	Enclosure type
	A	B	C	G	H	Diam. J				
base-mounted	63	74	72	52	58	4.2	8	35.6	171	LC*, LR*

Refer to "General Notes Relating to Pepperl+Fuchs Product Information".

Pepperl+Fuchs Group
www.pepperl-fuchs.comUSA: +1 330 486 0002
pa-info@us.pepperl-fuchs.comGermany: +49 621 776 2222
pa-info@de.pepperl-fuchs.comSingapore: +65 6779 9091
pa-info@sg.pepperl-fuchs.com



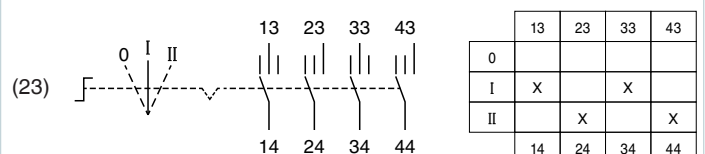
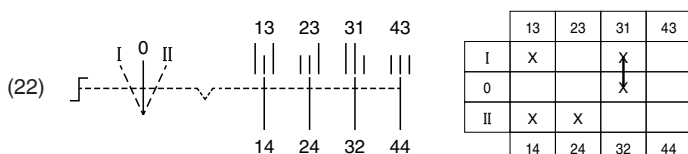
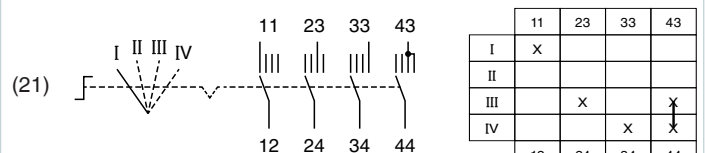
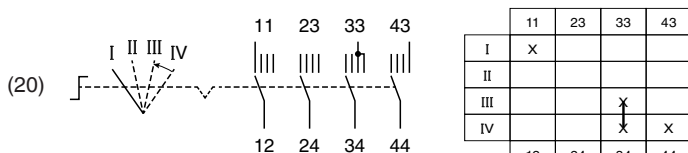
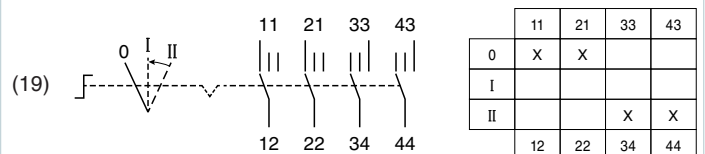
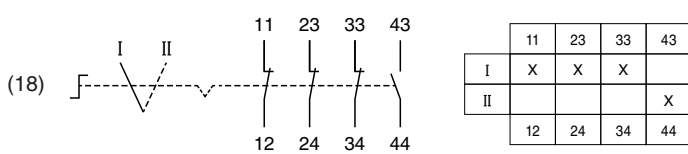
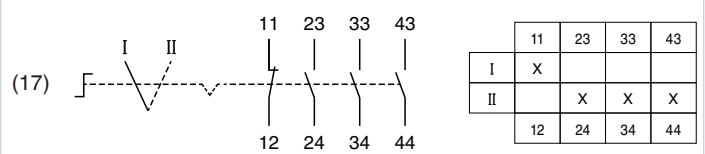
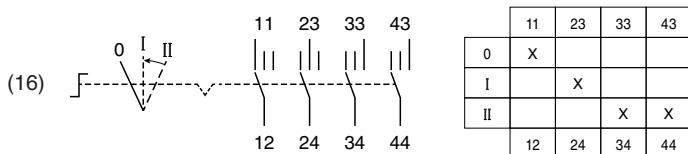
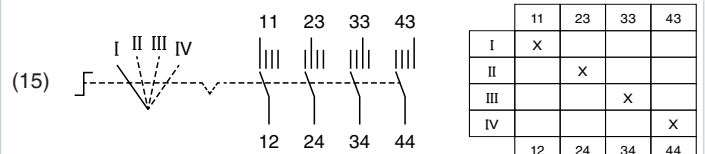
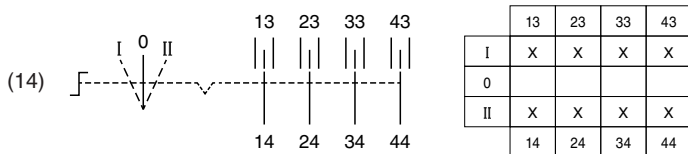
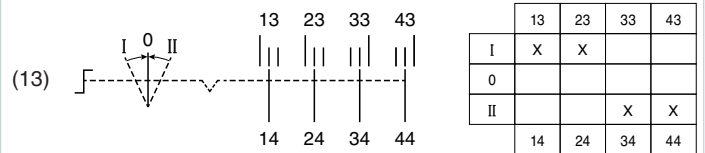
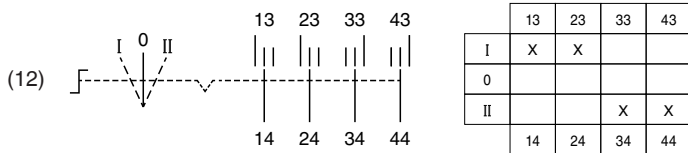
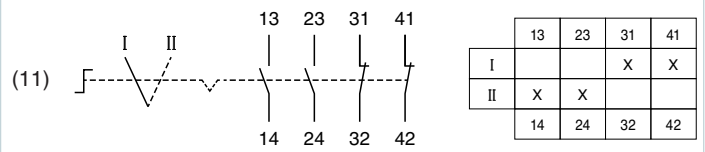
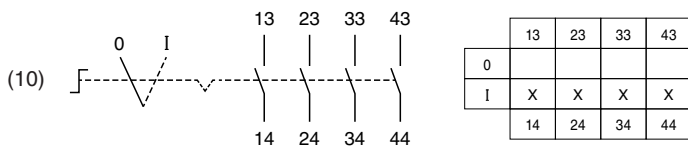

PEPPERL+FUCHS

Control Switches, 4 Pole Rotary Switching Blocks, Switching diagrams



Release date: 2022-05-12 Date of issue: 2022-05-12 Filename: t170923_eng.pdf

LED Indicators

LED Indicators Lenses		
Type	Lens color	Image
CFP.LR	red	
CFP.LG	green	
CFP.LO	amber	
CFP.LW	white	
CFP.LB	blue	

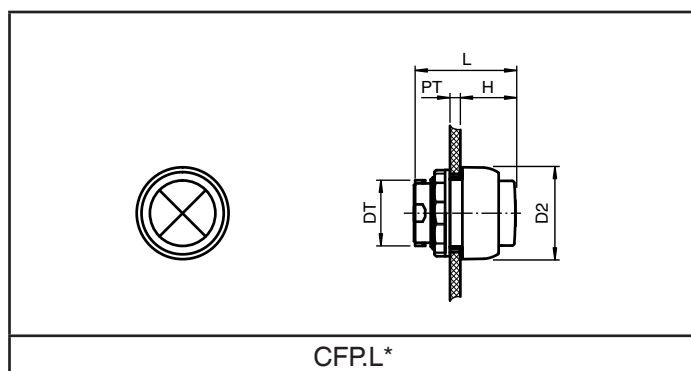

LED Heads - Technical Data

Mechanical specifications

Degree of protection IP66

Material

Housing Polyamide (PA)

Finish inherent color black

Washer gasket silicone

Ambient conditions

Ambient temperature -40 ... 55 °C (-40 ... 131 °F)

Service temperature -40 ... 65 °C (-40 ... 149 °F)

Data for application in connection with hazardous areas

EU-Type Examination Certificate CML 16 ATEX 3339U

Marking

 II 2 GD
Ex e IIC Gb
Ex tb IIIC Db

International approvals

IECEx approval IECEx CML 16.0114U

Conformity

Degree of protection EN 60529

CE marking 0102

General information

Supplementary information

EC-Type Examination Certificate, Statement of Conformity, Declaration of Conformity, Attestation of Conformity and instructions have to be observed where applicable. For information see www.pepperl-fuchs.com.

LED Heads - Dimensions

Diameter [mm]	Panel wall thickness [mm]	Diameter thru-hole [mm]	Length outside enclosure [mm]	Total length [mm]	Mass [g]	Mounting	Enclosure type
D2	PT	DT	H	L			
39	1 ... 6	30.6	23.6	43	20	use with base-mounted and cover-mounted LED modules	LC*, LR* FXL*, CS GR.CS*

LED Indicators

LED Modules

Type	Mounting	Rated operating voltage [V AC/DC]	Image
CFP.NI	base-mounted	10 ... 28, Ex ia	
CFP.NE	base-mounted	10 ... 28	
CFP.L	base-mounted	30 ... 250	

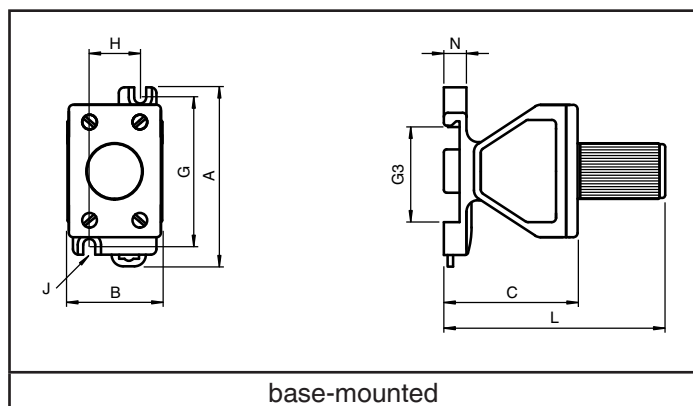

LED Modules - Technical Data

Electrical specifications

Operating voltage	250 V max.
Power consumption	2 W max.
Terminal capacity	2.5 mm ²
Terminal torque	0.8 Nm

Mechanical specifications

Degree of protection	IP20
----------------------	------

Material

Housing	Polyamide (PA)
---------	----------------

Ambient conditions

Service temperature	-40 ... 90 °C (-40 ... 194 °F)
---------------------	--------------------------------

Data for application in connection with hazardous areas

EU-Type Examination Certificate	CML 16 ATEX 3339U
---------------------------------	-------------------

Marking	 II 2 G Ex de IIC Gb
---------	--

Intrinsically safe variants *.NI, *.GI

Marking	 II 1 G Ex ia IIC Ga
---------	--

Voltage U _i	28 V
Current I _i	93 mA
Power P _i	0.651 W
Internal capacitance C _i	0 µF
Internal inductance L _i	0 mH

International approvals

IECEx approval	IECEx CML 16.0114U
----------------	--------------------

Conformity

Degree of protection	EN 60529
CE marking	0102

General information

Supplementary information	EC-Type Examination Certificate, Statement of Conformity, Declaration of Conformity, Attestation of Conformity and instructions have to be observed where applicable. For information see www.pepperl-fuchs.com .
---------------------------	--

LED Modules - Dimensions



Mounting	External dimension [mm]				Mounting holes [mm]			Mounting brackets [mm]	DIN rail receptacle [mm]	Mass [g]	Enclosure type
	A	B	C	L	G	H	Diam. J				
base-mounted	63	33.4	47	84	52	18	4.2	8	35.6	61	LC*, LR* GR.CS*

Refer to "General Notes Relating to Pepperl+Fuchs Product Information".

Pepperl+Fuchs Group
www.pepperl-fuchs.comUSA: +1 330 486 0002
pa-info@us.pepperl-fuchs.comGermany: +49 621 776 2222
pa-info@de.pepperl-fuchs.comSingapore: +65 6779 9091
pa-info@sg.pepperl-fuchs.com PEPPERL+FUCHS

Buzzer

Buzzer Modules

Type	Function	Color	Rated operating voltage [V AC/DC]	Image
CFP. BUZRF1	flashing buzzer	red	10 ... 28	
CFP. BUZRF2	flashing buzzer	red	30 ... 250	
CFP. BUZKS1	buzzer	black	10 ... 28	
CFP. BUZKS2	buzzer	black	30 ... 250	

Buzzer - Technical Data

Electrical specifications

Operating voltage	250 V max.
Power consumption	1 W max.
Terminal capacity	2.5 mm ²
Terminal torque	0.8 Nm
Sound level	60 dB at 30 cm

Mechanical specifications

Degree of protection	IP66
----------------------	------

Material

Housing	Polyamide (PA)
---------	----------------

Ambient conditions

Ambient temperature	-40 ... 55 °C (-40 ... 131 °F)
Service temperature	-40 ... 90 °C (-40 ... 194 °F)

Data for application in connection with hazardous areas

EU-Type Examination Certificate	CML 16 ATEX 3339U
---------------------------------	-------------------

Marking	 II 2 GD Ex e ib mb IIC Gb Ex ib tb IIIC Db
---------	--

International approvals

IECEx approval	IECEx CML 16.0114U
----------------	--------------------

Conformity

Degree of protection	EN 60529
CE marking	0102

General information

Supplementary information	EC-Type Examination Certificate, Statement of Conformity, Declaration of Conformity, Attestation of Conformity and instructions have to be observed where applicable. For information see www.pepperl-fuchs.com .
---------------------------	--

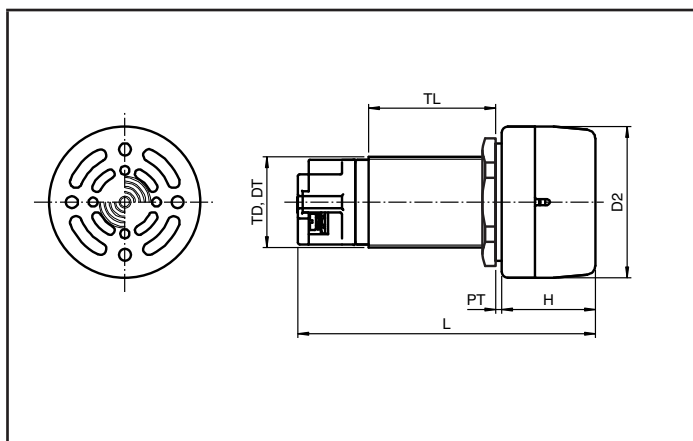

Buzzer - Dimensions

Actuator head diameter [mm]	Panel wall thickness [mm]	Diameter thru-hole [mm]	Length outside enclosure [mm]	Total length [mm]	Thread size	Thread length [mm]	Mass [g]	Mounting	Enclosure type
D2	PT	DT	H	L	TD	TL			
50	1 ... 35	30.6	31	98.5	M30 x 1.5	42	125	cover-mounted	LC*, LR* GR.CS* SR.CS* FXL*.CS

Ammeters

Ammeter Modules

Type	Rated operating current	Scales see table	Image
CFP.AA	0 ... 1 A	scale per specification	
CFP.AB	0 ... 5 A	scale per specification	
CFP.AC	4 ... 20 mA	scale 4 ... 20 / 40 mA	
CFP.AD	0 ... 20 mA	scale 0 ... 20 / 40 mA	

Ammeter Scales

Scales	Type Code	Scales	Type Code
0 ... 1 / 5 A	SA	0 ... 150 / 750 A	SM
0 ... 2.5 / 12.5 A	SB	0 ... 200 / 1000 A	SN
0 ... 5 / 25 A	SC	0 ... 250 / 1250 A	SO
0 ... 10 / 50 A	SD	0 ... 300 / 1500 A	SP
0 ... 15 / 75 A	SE	0 ... 400 / 2000 A	SQ
0 ... 20 / 100 A	SU	0 ... 500 / 2500 A	SR
0 ... 25 / 125 A	SF	0 ... 600 / 3000 A	SS
0 ... 30 / 150 A	SG	0 ... 1000 / 5000 A	ST
0 ... 40 / 200 A	SH	Scale as per specification	SZ
0 ... 50 / 250 A	SI		
0 ... 60 / 300 A	SJ		
0 ... 75 / 375 A	SK		
0 ... 100 / 500 A	SL		

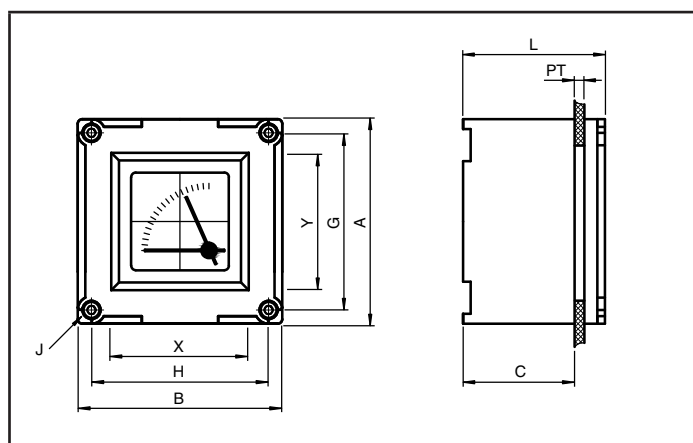

Ammeter Modules - Dimensions

External dimension [mm]				Viewing window [mm]		Panel wall thickness [mm]	Mounting holes [mm]			Mass [g]	Enclosure type
A	B	C	L	X	Y	PT	G	H	Diam. J		
70	70	59	75	54	50	1 ... 6	63	63	3.5	186	LC*, LR* FXL*.CS, SR.CS* GR.CS

Ammeter Modules - Technical Data

Electrical specifications

Operating voltage	500 V AC
Operating current	5 A max.
Accuracy class	1.5
Terminal capacity	2.5 mm ²
Terminal torque	0.8 Nm

Mechanical specifications

Degree of protection	IP66
Mounting	Meter window mounting kit

Material

Housing	Polyamide (PA)
---------	----------------

Ambient conditions

Service temperature	-40 ... 95 °C (-40 ... 203 °F)
---------------------	--------------------------------

Data for application in connection with hazardous areas

EU-Type Examination Certificate	CML 16 ATEX 3339U
Marking	 II 2 G Ex e IIC Gb

International approvals

IECEX approval	IECEX CML 16.0114U
----------------	--------------------

Conformity

Degree of protection	EN 60529
CE marking	0102

General information

Supplementary information

EC-Type Examination Certificate, Statement of Conformity, Declaration of Conformity, Attestation of Conformity and instructions have to be observed where applicable. For information see www.pepperl-fuchs.com.

Meter Window Mounting Kits

Type	Window including	Enclosure type
CFP.WB	base mounting kit	L*, GR.CS*
CFP.WL	cover mounting kit	FXL*.CS, SR.CS*

Voltmeters

Voltmeter Modules

Type	Rated operating voltage	Image
CFP.V6	0 ... 10 V	
CFP.V1	0 ... 25 V	
CFP.V2	0 ... 40 V	
CFP.V7	0 ... 50 V	
CFP.V8	0 ... 100 V	
CFP.V9	0 ... 120 V	
CFP.V3	0 ... 150 V	
CFP.V4	0 ... 250 V	
CFP.V5	0 ... 500 V	

Voltmeter Scales

included in module

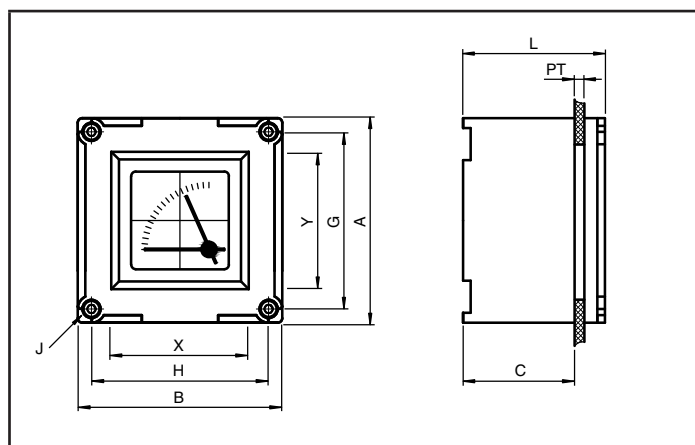

Voltmeter Modules - Dimensions

External dimension [mm]				Viewing window [mm]		Panel wall thickness [mm]	Mounting holes [mm]			Mass [g]	Enclosure type
A	B	C	L	X	Y	PT	G	H	Diam. J		
70	70	59	75	54	50	1 ... 6	63	63	3.5	186	LC*, LR* FXL*.CS, SR.CS* GR.CS*

Voltmeter Modules - Technical Data

Electrical specifications

Operating voltage	500 V AC
Accuracy class	1.5
Terminal capacity	2.5 mm ²
Terminal torque	0.8 Nm

Mechanical specifications

Degree of protection	IP66
Mounting	Meter window mounting kit

Material

Housing	Polyamide (PA)
---------	----------------

Ambient conditions

Service temperature	-40 ... 95 °C (-40 ... 203 °F)
---------------------	--------------------------------

Data for application in connection with hazardous areas

EU-Type Examination Certificate	CML 16 ATEX 3339U
Marking	 II 2 G Ex e IIC Gb

International approvals

IECEX approval	IECEX CML 16.0114U
----------------	--------------------

Conformity

Degree of protection	EN 60529
CE marking	0102

General information

Supplementary information	EC-Type Examination Certificate, Statement of Conformity, Declaration of Conformity, Attestation of Conformity and instructions have to be observed where applicable. For information see www.pepperl-fuchs.com .
---------------------------	--

Meter Window Mounting Kits

Type	Window including	Enclosure type
CFP.WB	base mounting kit	L*, GR.CS*
CFP.WL	cover mounting kit	FXL*.CS, SR.CS*

Potentiometers

Potentiometer Actuator Heads

Type	Enclosure type	Labeling	Image
CFP.R1	LC* LR*	0 ... 10	

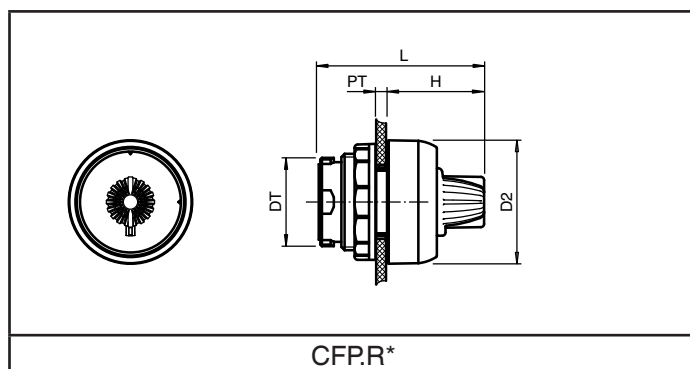

Actuator Heads - Technical Data

Mechanical specifications

Degree of protection IP66

Material

Housing Polyamide (PA)

Finish inherent color black

Washer gasket silicone

Ambient conditions

Ambient temperature -40 ... 55 °C (-40 ... 131 °F)

Service temperature -40 ... 65 °C (-40 ... 149 °F)

Data for application in connection with hazardous areas

EU-Type Examination Certificate CML 16 ATEX 3339U

Marking  II 2 GD
Ex e IIC Gb
Ex tb IIIC Db

International approvals

IECEX approval IECEX CML 16.0114U

Conformity

Degree of protection EN 60529

CE marking 0102

General information

Supplementary information EC-Type Examination Certificate, Statement of Conformity, Declaration of Conformity, Attestation of Conformity and instructions have to be observed where applicable. For information see www.pepperl-fuchs.com.

Potentiometer Actuator Heads - Dimensions

Actuator head diameter [mm]	Panel wall thickness [mm]	Diameter thru-hole [mm]	Length outside enclosure [mm]	Total length [mm]	Mass [g]	Mounting
D2	PT	DT	H	L		
39	1 ... 6	30.6	30.5	50.5	27	use with base-mounted and cover-mounted potentiometer modules

Potentiometers

Potentiometer Modules

Type	Mounting	Range [kΩ]	Image
CFP.3	base-mounted	0 ... 0.5	
CFP.1	base-mounted	0 ... 1	
CFP.2	base-mounted	0 ... 2	
CFP.5	base-mounted	0 ... 5	
CFP.0	base-mounted	0 ... 10	

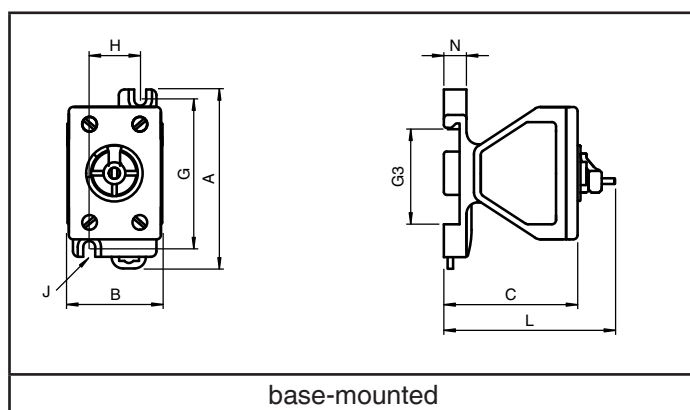

Potentiometer Modules - Technical Data

Electrical specifications

Operating voltage	200 V max.
Power consumption	0.1 W max.
Terminal capacity	2.5 mm ²
Terminal torque	0.8 Nm

Mechanical specifications

Degree of protection	IP20
----------------------	------

Material

Housing	Polyamide (PA)
---------	----------------

Ambient conditions

Service temperature	-55 ... 90 °C (-67 ... 194 °F)
---------------------	--------------------------------

Data for application in connection with hazardous areas

EU-Type Examination Certificate	CML 16 ATEX 3339U
---------------------------------	-------------------

Marking	 II 2 G Ex de IIC Gb
---------	--

International approvals

IECEx approval	IECEx CML 16.0114U
----------------	--------------------

Conformity

Degree of protection	EN 60529
CE marking	0575







General information







Supplementary information	EC-Type Examination Certificate, Statement of Conformity, Declaration of Conformity, Attestation of Conformity and instructions have to be observed where applicable. For information see www.pepperl-fuchs.com .
---------------------------	--

Potentiometer Modules - Dimensions

Mounting	External dimension [mm]				Mounting holes [mm]			Mounting brackets [mm]	DIN rail receptacle [mm]	Mass [g]	Enclosure type
	A	B	C	L	G	H	Diam. J				
base-mounted	63	34	50	60	52	18	4.2	8	35.6	69	LC*, LR*

Operating Elements Accessories

Accessory		
Type	Description	Image
CFP.BK	Blanking plug	
CFP.ZT	Extra small label holder with printed label as per specification	
CFP.ZS	Small label holder with printed label as per specification	
CFP.ZL	Large label holder with printed label as per specification	
CFP.ZEB	Emergency stop label, yellow, round	
CFP.ZEB.V2	Emergency stop label, yellow, round, engraved NOT HALT EMERGENCY STOP	
CFP.TP	Locknut spanner, plastic	

Accessory		
Type	Description	Image
CFP.ZB CFP.ZBR (1) (8)	Protective flap for small actuators, plastic, padlockable	
CFP.ZJ CFP.ZJR (1) (8)	Protective pushbutton flap with continuous operation, plastic, padlockable	
CFP.ZH (3)	Protective flap for double pushbutton, stainless steel, padlockable	
CFP.ZA CFP.ZAR (4) (8) (9)	Protective flap, plastic	
CFP.ZP CFP.ZPR (5) (8)	Emergency stop shroud, plastic, padlockable, supplied with padlock and 2 keys	
CFP.ZDT (6) (9)	Protective flap, stainless steel	
CFP.ZCT (7)	Protective flap, stainless steel, padlockable	

- (1) CFP.ZB* are designed for use with CFP.P* pushbuttons, CFP.I* illuminated pushbuttons, CFP.N* small switches, CFP.R* potentiometer actuators
- (2) CFP.ZJ* are designed for use with CFP.P* pushbuttons
- (3) CFP.ZH is designed for use with CFP.D* double pushbuttons
- (4) CFP.ZA* are designed for use with CFP.S* large switches, CFP.E* emergency stops
- (5) CFP.ZP* are designed for use with CFP.E4 emergency stop buttons, the shroud can either be used without the bar to avoid accidental operation or with the bar to padlock in the operated position
- (6) CFP.ZDT is designed for use with both CFP.E4 and CFP.E5 emergency stop buttons
- (7) CFP.ZCT is designed for use with both CFP.E4 and CFP.E5 emergency stop buttons. The shroud is used to padlock the emergency stop in the operated position and when not in use, the flap should be left open
- (8) Accessories that have two options, use a R at the end of the typecode for use with rail mounted contact blocks and those without R are used for cover mounted contact blocks only
- (9) Shrouds and flaps potentially prevent free and unimpaired access to an emergency stop button. These products may therefore only be used in applications where their use has been assessed and not found to cause unacceptable risk to health and safety of persons or damage to the protected machinery.