



Control Units Ex e, Panel Mount

PM*. *. *

- Customizable configuration of operators and contact modules as per specification
- Ex de and Ex tb certified
- Full equipment certified
- Polyamide housing for panel mount
- Installation in Zone 1, Zone 2, Zone 21 and Zone 22
- Cable Gland M20 integrated in protective cover
- Degree of protection IP66



Function

The versatile control units of the series PM* are available as standard off-the-shelf control units or can be flexibly equipped with a great variety of operators and contact configurations. The comprehensive range of control functions allow the configuration of each control unit to exactly meet any application requirements and ensure optimal space efficiency.

The enclosures are manufactured from polyamide and allow easy installation in appropriate industrial panels and enclosures. Each unit is individually certified as full equipment.

Durable materials and components of high quality allow the control units to be used in ambient temperatures between -40 °C and +50 °C.

Technical Data

Electrical specifications

Operating voltage	250 V max.
Operating current	16 A max.
Terminal capacity	2x 2.5 mm ²
Terminal torque	0.8 Nm
Function	see data table

Mechanical specifications

Cable type	non-armored cables
Clamping range (D)	5.5 ... 13 mm
Covering	Protective cover fully detachable
Cover fixing	Phillips head screw
Degree of protection	IP66
Cable entry	
Number of cable entries	1x M20 cable gland in protective cover
Material	
Housing	Polyamide (PA)
Finish	inherent color black
Seal	silicone
Washer gasket	silicone
Mass	max. 150 g
Dimensions	see data table
Tightening torque	
Nut torque at enclosure (SW1)	2 Nm (SW1)
Mounting	via actuator head

Ambient conditions

Ambient temperature	-40 ... 50 °C (-40 ... 122 °F)
---------------------	--------------------------------

2021-11-25 13:53:30 / T183422 / ENG

Refer to "General Notes Relating to Pepperl+Fuchs Product Information".

Pepperl+Fuchs Group
www.pepperl-fuchs.com

USA: +1 330 486 0002
pa-info@us.pepperl-fuchs.com

Germany: +49 621 776 2222
pa-info@de.pepperl-fuchs.com

Singapore: +65 6779 9091
pa-info@sg.pepperl-fuchs.com

PEPPERL+FUCHS

Technical Data

Data for application in connection with hazardous areas

EU-type examination certificate	CML 16 ATEX 3106X
Marking	1 II 2 GD Ex de IIC T6 Gb Ex tb IIIC T80 °C Db
International approvals	
IECEX approval	IECEX CML 16.0046X
Conformity	
Degree of protection	EN 60529
Usage category	IEC / EN 60947
CE marking	0080 or 0102, see type label
General information	
Ordering information	For standard configured units please see pdf data sheet. For configuration details please contact Customer Service.
Supplementary information	EC-Type Examination Certificate, Statement of Conformity, Declaration of Conformity, Attestation of Conformity and instructions have to be observed where applicable. For information see www.pepperl-fuchs.com .

Type Code

Function			
PMP	Pushbutton		
PMI	Illuminated pushbutton		
PMS	Control switch		
PML	LED indicator		
PMR	Potentiometer		
Actuator heads			
xx	see separate table		
Contact blocks and modules			
xx	see separate table		
Configuration			
xx	see separate table		
Example			
Function	Actuator heads	Contact blocks and modules	Configuration
PMP	.E4	.C	.11
Example: Pushbutton for panel mount, mushroom button 40 mm, red, twist-to-release, contact block with 1x NO / 1x NC contacts			

Dimensions

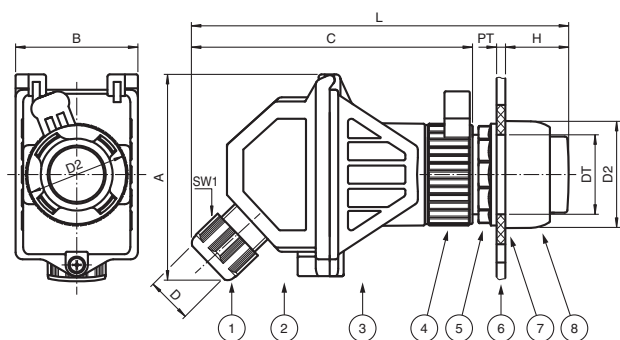

Legend

1	Cable gland	A	Height
2	Protective cover	B	Width
3	Contact module	C	Depth
4	Bayonet catch	D	Clamping range, cable sheath diameter
5	Locknut	DT	Diameter thru-hole
6	Panel / enclosure wall	D2	Outer diameter actuator head
7	Flat gasket	H	Length outside enclosure
8	Actuator head	L	Total length
		PT	Panel / enclosure wall thickness

Details see data table

Type	Actuator head diameter [mm]	Length outside enclosure [mm]	Total length [mm]	Height [mm]	Width [mm]	Depth [mm]	Width across flats [mm]	Diameter thru-hole [mm]	Panel wall thickness [mm]	Image example
	D2	H	L	A	B	C	SW1	DT	PT	
PMP.P*	39	15.5	128	77	44	105	24	30.6	1 ... 6	
PMP.D*	70 x 39	15.5	128	77	44	105	24	30.6	1 ... 6	
PMPE4*	40	41.8	153.7	77	44	105	24	30.6	1 ... 6	
PMPE5*	55	41.8	153.7	77	44	105	24	30.6	1 ... 6	
PMP.J*	39	41.6	154.1	77	44	105	24	30.6	1 ... 6	
PMI.I*	39	17.5	130	77	44	105	24	30.6	1 ... 6	
PMS.N*	39	30.6	143.1	77	44	105	24	30.6	1 ... 6	
PMS.K*	39	33.3	145.8	77	44	105	24	30.6	1 ... 6	
PML.L*	39	23.6	136.1	77	44	105	24	30.6	1 ... 6	
PMR.R*	39	30.5	143	77	44	105	24	30.6	1 ... 6	

2021-11-25 13:53:30 / T183422 / ENG

Refer to "General Notes Relating to Pepperl+Fuchs Product Information".

Pepperl+Fuchs Group
www.pepperl-fuchs.comUSA: +1 330 486 0002
pa-info@us.pepperl-fuchs.comGermany: +49 621 776 2222
pa-info@de.pepperl-fuchs.comSingapore: +65 6779 9091
pa-info@sg.pepperl-fuchs.com

Standard Variants, Pushbuttons and Emergency Stop Buttons



Type	Function	Color	Labeling	Operator action	Number of poles	Contact configuration	Switching configuration	Switching diagram	Usage category
PMP. PZ1.C.02	pushbutton	selection of red, green, amber, white, blue, black	-	spring return	2	2x NC	-		AC12 - 12 ... 250 V AC - 16 A AC15 - 12 ... 250 V AC - 10 A DC13 - 12 ... 110 V DC - 1 A DC13 - 12 ... 24 V DC - 1 A
PMP. PZ1.C.11	pushbutton		-	spring return	2	1x NO / 1x NC	-		
PMP. PZ1.C.20	pushbutton		-	spring return	2	2x NO	-		
PMP. DZ3.C.02	double pushbutton	selection of red '0', green 'I', black 'I', blue 'RESET', white, amber	-	spring return	2	2x NC	-		AC12 - 12 ... 250 V AC - 16 A AC15 - 12 ... 250 V AC - 10 A DC13 - 12 ... 110 V DC - 1 A DC13 - 12 ... 24 V DC - 1 A
PMP. DZ3.C.11	double pushbutton		-	spring return	2	1x NO / 1x NC	-		
PMP. DZ3.C.20	double pushbutton		-	spring return	2	2x NO	-		
PMP. E4.C.02	mushroom button 40 mm	red	-	latching, twist to release	2	2x NC	-		AC12 - 12 ... 250 V AC - 16 A AC15 - 12 ... 250 V AC - 10 A DC13 - 12 ... 110 V DC - 1 A DC13 - 12 ... 24 V DC - 1 A
PMP. E4.C.11	mushroom button 40 mm	red	-	latching, twist to release	2	1x NO / 1x NC	-		
PMP. E5.C.02	mushroom button 55 mm	red	-	latching, twist to release	2	2x NC	-		
PMP. E5.C.11	mushroom button 55 mm	red	-	latching, twist to release	2	1x NO / 1x NC	-		
PMP. JR.C.02	mushroom button	red	-	latching, key release	2	2x NC	-		
PMP. JR.C.11	mushroom button	red	-	latching, key release	2	1x NO / 1x NC	-		

2021-11-25 13:53:30 / T183422 / ENG

Refer to "General Notes Relating to Pepperl+Fuchs Product Information".

Pepperl+Fuchs Group
www.pepperl-fuchs.comUSA: +1 330 486 0002
pa-info@us.pepperl-fuchs.comGermany: +49 621 776 2222
pa-info@de.pepperl-fuchs.comSingapore: +65 6779 9091
pa-info@sg.pepperl-fuchs.com

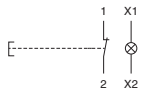
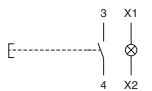
Standard Variants, Illuminated Pushbuttons and Control Switches

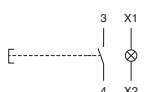
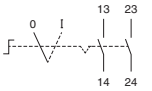
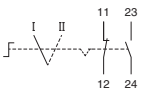
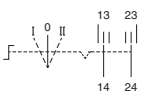
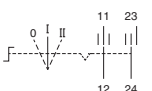
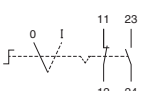
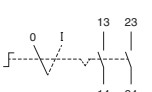
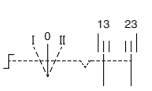
Type	Function	Color	Labeling	Operator action	Number of poles	Contact configuration	Switching configuration	Switching diagram	Usage category
PMI. IR.I.W.01	illuminated pushbutton	red	-	spring return	1	1x NC	-		AC15 - 20 ... 250 V AC - 10 A DC13 - 20 ... 24 V DC - 1 A
PMI. IR.I.W.10	illuminated pushbutton	red	-	spring return	1	1x NO	-		
PMI. IG.I.W.01	illuminated pushbutton	green	-	spring return	1	1x NC	-		
PMI. IG.I.W.10	illuminated pushbutton	green	-	spring return	1	1x NO	-		
PMS. N6.C.20	control switch, small	black	0 - I	engage - engage	2	2x NO	2 position changeover with left OFF		AC12 - 12 ... 250 V AC - 16 A AC15 - 12 ... 250 V AC - 10 A DC13 - 12 ... 110 V DC - 1 A DC13 - 12 ... 24 V DC - 1 A
PMS. N7.C.11	control switch, small	black	I - II	engage - engage	2	1x NO / 1x NC	2 position changeover		
PMS. N8.C.20	control switch, small	black	I - O - II	engage - engage - engage	2	2x NO	3 position changeover with center OFF		
PMS. N9.C.11	control switch, small	black	0 - I - II	engage - engage - engage	2	1x NO / 1x NC	3 position changeover with left OFF		
PMS. K6.C.11	key switch	black / silver	0 - I	engage - engage	2	1x NO / 1x NC	2 position changeover with left OFF		
PMS. K6.C.20	key switch	black / silver	0 - I	engage - engage	2	2x NO	2 position changeover with left OFF		
PMS. K8.C.20	key switch	black / silver	I - 0 - II	engage - engage - engage	2	2x NO	3 position changeover with center OFF		

Standard Variants, LED Indicators

Type	Function	Color	Labeling	Operator action	Number of poles	Contact configuration	Switching configuration	Rated operating voltage
PML.LR.L.W.2	LED indicator	red	-	-	-	-	-	20 ... 250 V AC 20 ... 24 V DC
PML.LG.L.W.2	LED indicator	green	-	-	-	-	-	
PML.LO.L.W.2	LED indicator	amber	-	-	-	-	-	
PML.LW.L.W.2	LED indicator	white	-	-	-	-	-	
PML.LB.L.W.2	LED indicator	blue	-	-	-	-	-	

Standard Variants, Potentiometers

Type	Function	Color	Labeling	Operator action	Number of poles	Contact configuration	Switching configuration	Range
PMR.R2.P.0.5K	potentiometer	black	0 ... 10	continuously rotary	-	-	-	0 ... 0.5 kΩ
PMR.R2.P.1K	potentiometer	black	0 ... 10	continuously rotary	-	-	-	0 ... 1 kΩ
PMR.R2.P.2K	potentiometer	black	0 ... 10	continuously rotary	-	-	-	0 ... 2 kΩ
PMR.R2.P.10K	potentiometer	black	0 ... 10	continuously rotary	-	-	-	0 ... 10 kΩ

Type Code / Model Number Details

Function

PMP Pushbutton

Actuator heads

- | **PZ1** Pushbutton with unlabeled inserts colored amber, black, blue, green, red, white
- | **DZ3** Double pushbutton, inserts with labeling: red '0', green 'I', black 'I', blue 'RESET'; without: white, amber
- | **JR** Mushroom button 39 mm, red, key-release
- | **E4** Mushroom button 40 mm, red, twist-to-release
- | **E5** Mushroom button 55 mm, red, twist-to-release

Contact blocks and modules

- | **C.11** Contact block with 1x NO / 1x NC contacts
- | **C.02** Contact block with 2x NC contacts
- | **C.20** Contact block with 2x NO contacts

Function

PMI Illuminated pushbutton

Actuator heads

- | **IR** Red illuminated pushbutton
- | **IG** Green illuminated pushbutton

Contact blocks and modules

- | **I.W.01** LED contact module 20 ... 250 V AC with 1x NC contact
- | **I.W.10** LED contact module 20 ... 250 V AC with 1x NO contact

Function

PML LED indicator

Actuator heads

- | **LR** Red indicator lens cover
- | **LG** Green indicator lens cover
- | **LO** Amber indicator lens cover
- | **LW** White indicator lens cover
- | **LB** Blue indicator lens cover

Contact blocks and modules

- | **L.W.2** LED module 20 ... 250 V AC

Function

PMS Control switch

Actuator heads

- | **N6** Small switch actuator, 2 position with left OFF, labeled "0 - I"
- | **N7** Small switch actuator, 2 position, labeled "I - II"
- | **N8** Small switch actuator, 3 position with center OFF, labeled "I - 0 - II"
- | **N9** Small switch actuator, 3 position with left OFF, labeled "0 - I - II"

Contact blocks and modules

- | **C.11** Contact block with 1x NO / 1x NC contacts
- | **C.20** Contact block with 2x NO contacts

Function

PMR Potentiometer

Actuator heads

- | **R2** Potentiometer actuator, black, labeled "0 - 10"

Contact blocks and modules

- | **P.0.5K** Potentiometer block 500 Ω
- | **P.1K** Potentiometer block 1,000 Ω
- | **P.2K** Potentiometer block 2,000 Ω
- | **P.10K** Potentiometer block 10,000 Ω