



Control Stations Ex e, Glass-Fiber Reinforced Polyester (GRP)

GR.CS*

- Carbon loaded, antistatic glass-fiber reinforced polyester
- Installation in Zone 1, Zone 2, Zone 21 and Zone 22
- Ex db eb, Ex ib and Ex tb certified
- Up to 68 operators per control station
- 7 enclosure size options
- Customizable configuration of operators, cable entry quantities and cable gland types as per specification
- Wide range of labels and accessories available
- Modern design with high impact resistance
- Easy installation due to easily accessible mounting points
- Wide ambient temperature range

Control Stations Ex e, Glass-Fiber Reinforced Polyester (GRP)



Function

The GR.CS* series is a purposely designed range of control stations that can be equipped with operators, contact blocks, terminals and entry devices to meet your exact specification. Pepperl+Fuchs solution engineering teams provide any custom configurations including combinations of terminals and control elements.

The standardized GR* enclosure series for all Pepperl+Fuchs products consists of carbon-loaded, glass-fiber reinforced polyester with stainless steel cover screws. This series provides an anti-static, UV stabilized and corrosion resistant solution. Many features provide for easy installation and handling.

Technical Data

Electrical specifications	
Operating voltage	400 V AC max.
Operating current	16 A max.
Terminal capacity	2.5 mm ²
Terminal torque	0.8 Nm
Mechanical specifications	
Enclosure cover	fully detachable
Cover fixing	see data table
Screws	stainless steel combination Phillips and slotted screw
Cover seal	foamed silicone
Degree of protection	IP66
Cable entry	cable glands as per specification
Material	
Enclosure	carbon loaded, antistatic glass-fiber reinforced polyester (GRP)
Finish	inherent color black
Grounding plate	2 mm brass optional
Mass	see data table valid for empty enclosure, will increase according to integrated components
Dimensions	see data table
Mounting	see data table
Grounding	none as standard optional M6 or M8 internal/external brass nickel-plated grounding bolt optional M6 or M8 internal/external stainless steel grounding bolt
Ambient conditions	
Ambient temperature	-40 ... 55 °C (-40 ... 131 °F) optional -50 ... 55 °C (-58 ... 131 °F) depending on integrated components

Release date: 2026-03-11 Date of issue: 2026-03-11 Filename: t189602_eng.pdf

Refer to "General Notes Relating to Pepperl+Fuchs Product Information".

Pepperl+Fuchs Group
www.pepperl-fuchs.com

USA: +1 330 486 0002
pa-info@us.pepperl-fuchs.com

Germany: +49 621 776 2222
pa-info@de.pepperl-fuchs.com

Singapore: +65 6779 9091
pa-info@sg.pepperl-fuchs.com

PEPPERL+FUCHS

Technical Data

Data for application in connection with hazardous areas

EU-type examination certificate	CML 16 ATEX 3009X
Marking	Ex II 2 GD Ex db eb mb IIC T* Gb Ex ib IIC T* Gb Ex db eb ib mb op pr IIC T* Gb Ex tb IIIC T** °C Db T6/T80 °C @ Ta +40 °C T5/T95 °C @ Ta +55 °C T4/T130 °C @ Ta +55 °C
International approvals	
IECEx approval	IECEx CML 16.0008X
UKCA approval	CML 22 UKEX 2550X
ECAS approval	25-12-177084/E25-12-184562/NB0002
IA approval	MASC S/22-8362X
CCC approval	2020322304002545
Conformity	
Degree of protection	EN 60529
CE marking	2829
General information	
Ordering information	This device will be delivered completely configured and assembled ready for use. For configuration details please contact Customer Service.
Supplementary information	EC-Type Examination Certificate, Statement of Conformity, Declaration of Conformity, Attestation of Conformity and instructions have to be observed where applicable. For information see www.pepperl-fuchs.com .
Accessories	
Optional accessories	M6 or M8 internal/external brass nickel-plated grounding bolts M6 or M8 internal/external stainless steel grounding bolts grounding plate, brass Grounding Rail hinges, polyamide mounting block for DIN mounting rail, polyamide engraved traffolyte tag label engraved AISI 316L stainless steel tag label color in-fill stainless steel tag label
Indicators/operating means	
Control elements	small footprint max. 68 see data table all NC contacts have a direct opening action for emergency stop functions

Type Code

1	2	3	4	5	6	7	8
GR	***	**	**	**	*	-	****
GR	CSE	18	24	10	B	S	0001

Example: GR.CSE.18.24.10.B-S0001

Control Station increased safety, material GRP, size 18x24x10 cm, landscape orientation with face B at bottom, standard product

1	Enclosure type
GR	glass faser reinforced polyester (GRP)
2	Type of solution
CSE	control station (Ex e)
CSI	control station (Ex i)
CSM	control station, various types of explosion protection, e.g. (Ex e, Ex i) or (Ex e, Ex op pr)
3	Height [cm]
n	see dimensions data table
4	Width [cm]
n	see dimensions data table
5	Depth [cm]
n	see dimensions data table

Type Code

6	Cable entry face orientation
B	face [B] at bottom
D	face [D] at bottom
7	Variant
S	standard product
C	configured product
CA	configured and adapted product
Y	engineered product
8	Variant number
xxxx	consecutive item number

Dimensions and Enclosure Details

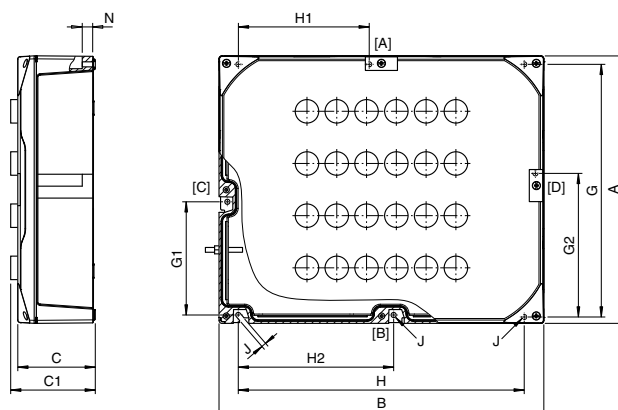

Type	External dimensions [mm]										Mounting screws qty.	Mass approx. [kg]	Cover screws		
	A	B	C	C1 max.	G	H	H1	H2	J	N			Mx	qty.	Torque [Nm]
GR.CS*.18.18.10	179	179	104	169	126	156	-	-	7	18	2	1.4	M6	4	3.5
GR.CS*.18.24.10	179	239	104	169	156	186	-	-	7	18	2	1.7	M6	4	3.5
GR.CS*.18.36.10	179	359	104	169	156	306	-	-	7	18	4	2.4	M6	4	3.5
GR.CS*.18.36.17	179	359	166.5	231.5	156	306	-	-	7	18	4	3.1	M6	4	3.5
GR.CS*.36.36.10	359	359	104	169	306	336	-	-	7	18	4	3.7	M6	4	3.5
GR.CS*.36.36.17	359	359	166.5	231.5	306	336	-	-	7	18	4	4.6	M6	4	3.5
GR.CS*.36.72.17	359	719	166.5	231.5	336	666	316.5	349.5	7	18	6	8.3	M6	6	3.5

Mass is valid for empty enclosure, it will increase according to integrated components and cable glands

Control Elements max. Quantity per Enclosure Type

Type	Control elements quantity max.		
	small footprint	large footprint	viewing windows
GR.CS*.18.18.10	6	2	2
GR.CS*.18.24.10	8	4	2
GR.CS*.18.36.10	14	6	4
GR.CS*.18.36.17	14	6	4
GR.CS*.36.36.10	32	16	12
GR.CS*.36.36.17	32	16	12
GR.CS*.36.72.17	68	32	24

Quantities are based on landscape enclosure orientation with horizontal DIN mounting rails, they may vary with vertical rails

Operating Elements Configuration

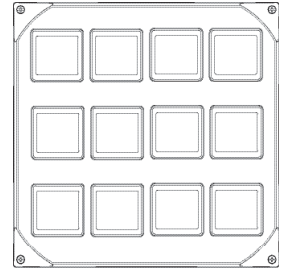
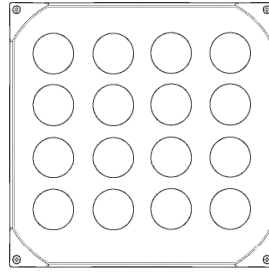
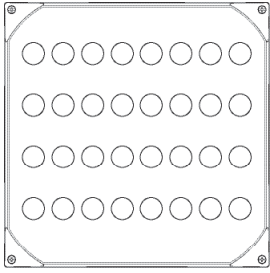

Example based on GR.CS*.36.36.10

Left (small footprint):

Small operators with small label holder and 2 pole contact blocks

Small operators include all pushbuttons, small switching actuators, LED indicators and potentiometers

Middle (large footprint):

Large switching actuators and all operators fitted with 4 pole contact modules, protective lid or padlockable shroud

Right:

Viewing windows with ammeter or voltmeter and operators with large label holders

Notes:























The use of label holders depends on operating elements configuration

The position of the grounding bolt can vary depending on configuration

All NC contacts have a direct opening action for emergency stop functions

For further configurations please contact Pepperl+Fuchs

Pushbuttons and Emergency Stops

Pushbuttons Actuator Heads			
Type	Color	Labeling	Image
CFP.PA	red	none	
CFP.PR	red	0	
CFP.PC	red	STOP	
CFP.PD	red	OFF	
CFP.PE	green	none	
CFP.PG	green	I	
CFP.PI	green	II	
CFP.PF	green	START	
CFP.PH	green	ON	
CFP.PY	yellow	none	
CFP.PO	amber	none	
CFP.PW	white	none	
CFP.PB	blue	none	
CFP.PJ	blue	RESET	
CFP.PK	black	none	
CFP.PL	black	0	
CFP.PN	black	I	
CFP.PP	black	II	
CFP.PQ	black	III	
CFP.PT	black	IV	
CFP.PU	black	arrow up	
CFP.PV	black	arrow down	
CFP.PZ*	see individual datasheets		

Actuator Heads - Technical Data

Mechanical specifications	
Dimensions	see data table
Mounting	use with base-mounted and lid-mounted contact modules
Degree of protection	IP66
Mass	see data table
Material	
Housing	Polyamide (PA)
Finish	inherent color black
Washer gasket	silicone
Ambient conditions	
Ambient temperature	-40 ... 55 °C (-40 ... 131 °F)
Service temperature	-40 ... 65 °C (-40 ... 149 °F)
Data for application in connection with hazardous areas	
EU-Type Examination Certificate	CML 16 ATEX 3339U
Marking	 II 2 GD Ex e IIC Gb Ex tb IIIC Db
International approvals	
IECEX approval	IECEX CML 16.0114U
Conformity	
Degree of protection	EN 60529
CE marking	2829
General information	
Supplementary information	EC-Type Examination Certificate, Statement of Conformity, Declaration of Conformity, Attestation of Conformity and instructions have to be observed where applicable. For information see www.pepperl-fuchs.com .
Enclosure type	LC*, LR* FXL*.CS, SR.CS* GR.CS*

Pushbuttons and Emergency Stops

Emergency Stops Actuator Heads

Type	Function	Color	Labeling	Operator action	Actuator head diameter	Switching diagram	Image
CFP.E4	mushroom button	red	none	latching, twist to release	40 mm		
CFP.E5	mushroom button	red	none	latching, twist to release	55 mm		
CFP.JR	mushroom button	red	none	latching, key release	39 mm		

Other Pushbuttons Actuator Heads

Type	Function	Color	Labeling	Operator action	Actuator head diameter	Switching diagram	Image
CFP.D*	pushbutton	red / green	0 - I	spring return	70 mm x 39 mm		
CFP.MK	mushroom button	black	none	spring return	39 mm		
CFP.MR	mushroom button	red	none	spring return	39 mm		
CFP.MG	mushroom button	green	none	spring return	39 mm		

Pushbuttons and Emergency Stops

Pushbuttons and Emergency Stops - Dimensions

Type	Function	Actuator head diameter [mm]	Panel wall thickness [mm]	Diameter thru-hole [mm]	Length outside enclosure [mm]	Total length [mm]	Mass [g]
		D2	PT	DT	H	L	
CFP.P*	pushbutton	39	1 ... 6	30.6	15.5	35.4	25
CFP.D*	double pushbutton	70 x 39	1 ... 6	30.6	15.5	35.4	38
CFP.E4	emergency stop	40	1 ... 6	30.6	41.8	62.1	52
CFP.E5	emergency stop	55	1 ... 6	30.6	41.8	62.1	58
CFP.JR	key release mushroom button	39	1 ... 6	30.6	49.5	70	65
CFP.M*	mushroom button	37	1 ... 6	30.6	41.2	60.7	46

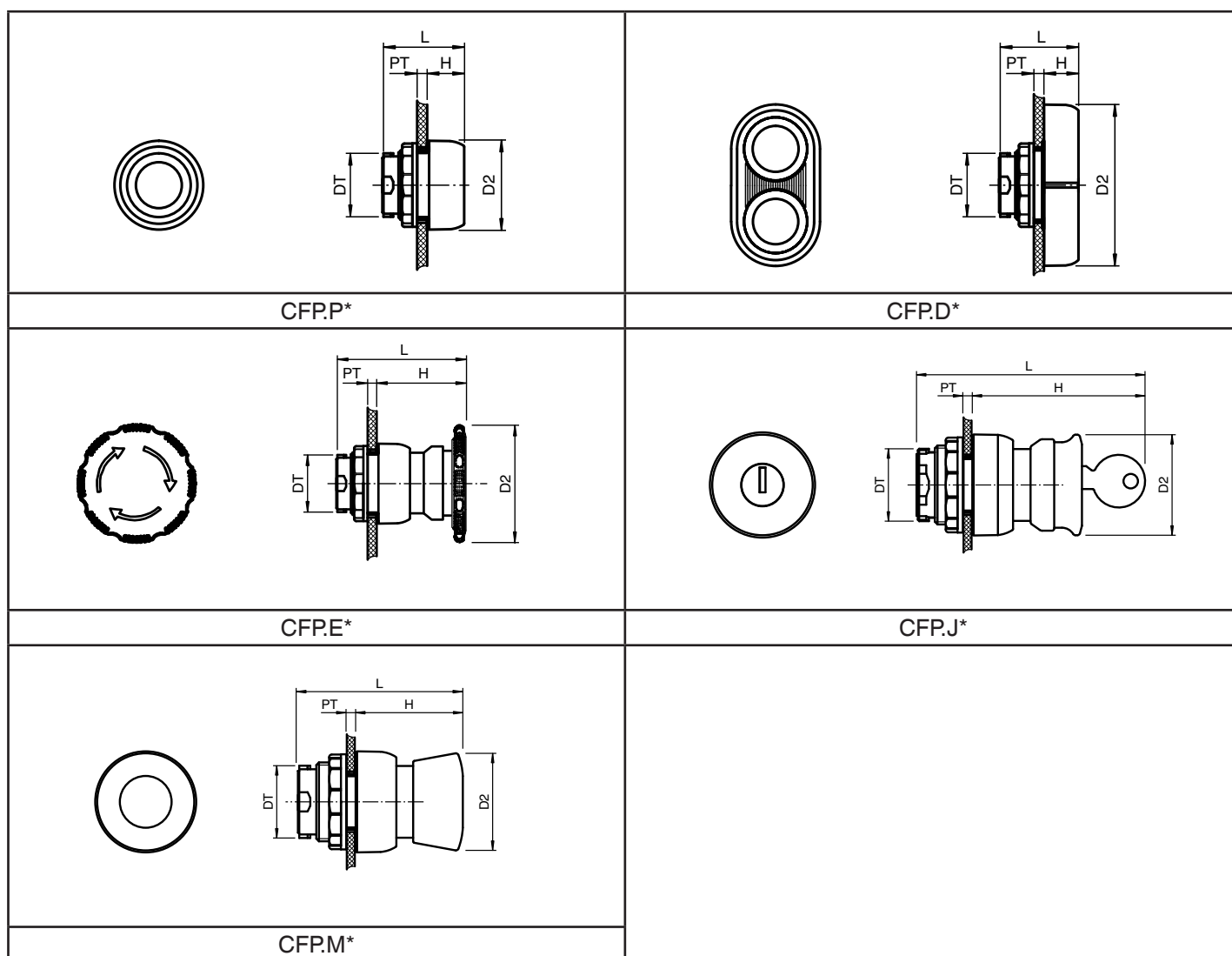

Pushbuttons and Emergency Stops

Contact Blocks

Type	Mounting	Number of poles	Contact configuration	Switching diagram see overview	Image
CFPM	base-mounted	2	1x NO / 1x NC		
CFPC	base-mounted	2	2x NC		
CFPO	base-mounted	2	2x NO		

Contact Blocks - Technical Data

Electrical specifications

Operating voltage	250 V max.
Operating current	16 A max.
Terminal capacity	2.5 mm ²
Terminal torque	0.8 Nm
Usage category	AC12: 12 ... 250 V AC - 16 A AC15: 12 ... 250 V AC - 10 A DC13: 12 ... 110 V DC - 1 A DC13: 12 ... 24 V DC - 1 A

Mechanical specifications

Mechanical life	1000000 switching operations
Degree of protection	IP20

Material

Housing	Polyamide (PA)
---------	----------------

Ambient conditions

Service temperature	-40 ... 90 °C (-40 ... 194 °F)
---------------------	--------------------------------

Data for application in connection with hazardous areas

EU-Type Examination Certificate	CML 16 ATEX 3339U
---------------------------------	-------------------

Marking	II 2 G Ex de IIC Gb
---------	------------------------

Contact Blocks - Technical Data continued

International approvals

IECEx approval	IECEx CML 16.0114U
----------------	--------------------

Conformity

Degree of protection	EN 60529
Usage category	IEC / EN 60947
CE marking	2829

General information

Supplementary information	EC-Type Examination Certificate, Statement of Conformity, Declaration of Conformity, Attestation of Conformity and instructions have to be observed where applicable. For information see www.pepperl-fuchs.com .
---------------------------	--

Pushbuttons and Emergency Stops

Contact Blocks - Dimensions

Mounting	External dimension [mm]			Mounting holes [mm]			Mounting brackets [mm]	DIN mounting rail receptacle [mm]	Mass [g]	Enclosure type
	A	B	C	G	H	Diam. J	N	G3		
base-mounted	63	33.4	50	52	18	4.2	8	35.6	68	LC*, LR* GR.CS* SR.CS*

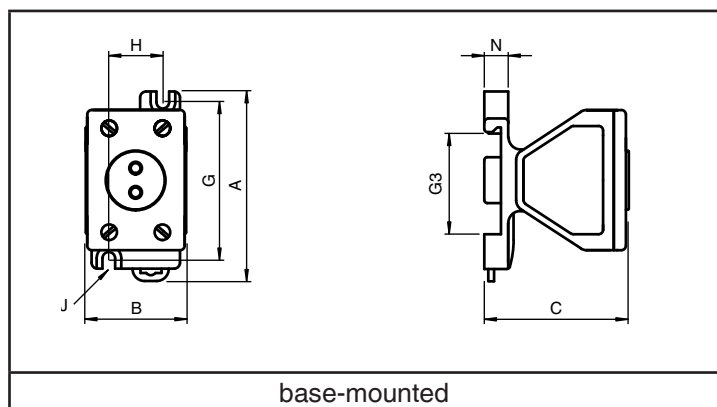

Illuminated Pushbuttons

Illuminated Pushbuttons Actuator Heads

Type	Lens color	Operator action	Switching diagram	Image
CFP.IR	red	spring return		
CFP.IG	green	spring return		
CFP.IO	amber	spring return		
CFP.IW	white	spring return		
CFP.IB	blue	spring return		

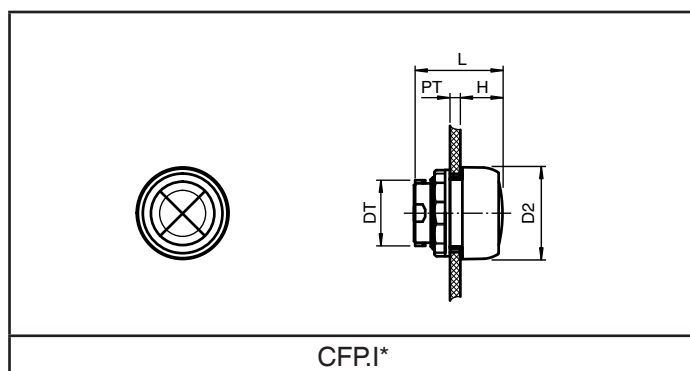

Actuator Heads - Technical Data

Mechanical specifications

Degree of protection IP66

Material

Housing Polyamide (PA)

Finish inherent color black

Washer gasket silicone

Ambient conditions

Ambient temperature -40 ... 55 °C (-40 ... 131 °F)

Service temperature -40 ... 65 °C (-40 ... 149 °F)

Data for application in connection with hazardous areas

EU-Type Examination Certificate CML 16 ATEX 3339U

Marking

II 2 GD
Ex e IIC Gb
Ex tb IIIC Db

International approvals

IECEx approval IECEx CML 16.0114U

Conformity

Degree of protection EN 60529

CE marking 2829

General information

Supplementary information

EC-Type Examination Certificate, Statement of Conformity, Declaration of Conformity, Attestation of Conformity and instructions have to be observed where applicable. For information see www.pepperl-fuchs.com.

Illuminated Pushbuttons Actuator Heads - Dimensions

Actuator head diameter [mm]	Panel wall thickness [mm]	Diameter thru-hole [mm]	Length outside enclosure [mm]	Total length [mm]	Mass [g]	Mounting	Enclosure type
D2	PT	DT	H	L			
39	1 ... 6	30.6	17.5	36.8	21	use with base-mounted and cover-mounted contact modules	LC*, LR* FXL*.CS GR.CS* SR.CS*

Illuminated Pushbuttons

LED Contact Modules

Type	Mounting	Operating voltage [V]	Number of poles	Contact configuration	Switching diagram	Image
CFP.IL	base-mounted	10 ... 30 V AC/DC	1	1x NO		
CFP.I	base-mounted	20 ... 250 V AC	1	1x NO		
CFP.II	base-mounted	10 ... 30 V AC/DC Ex ia	1	1x NO		
CFP.JL	base-mounted	10 ... 30 V AC/DC	1	1x NC		
CFP.J	base-mounted	20 ... 250 V AC	1	1x NC		
CFP.JI	base-mounted	10 ... 30 V AC/DC Ex ia	1	1x NC		

Illuminated Pushbuttons

LED Contact Modules - Dimensions

Mounting	External dimension [mm]				Mounting holes [mm]			Mounting brackets [mm]	DIN rail receptacle [mm]	Mass [g]	Enclosure type
	A	B	C	L	G	H	Diam. J	N	G3		
base-mounted	63	33.4	47	82	52	18	4.2	8	35.6	72	LC*, LR* GR.CS* SR.CS*

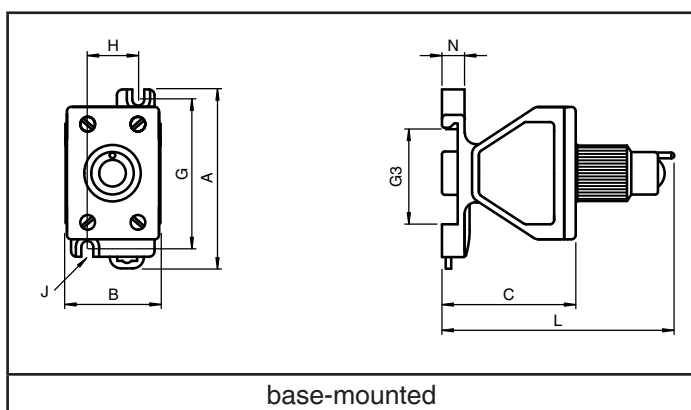

LED Modules - Technical Data

Electrical specifications

Operating voltage	250 V max.
Operating current	10 A max.
Power consumption	1 W max.
Terminal capacity	2.5 mm ²
Terminal torque	0.8 Nm
Usage category	AC15: 10 ... 250 V AC - 10 A DC13: 10 ... 24 V DC - 1 A

Mechanical specifications

Mechanical life	1000000 switching operations
Degree of protection	IP20

Material

Housing	Polyamide (PA)
---------	----------------

Ambient conditions

Service temperature	-55 ... 85 °C (-67 ... 185 °F)
Ambient temperature	-55 ... 55 °C (-67 ... 131 °F)

Data for application in connection with hazardous areas

EU-Type Examination Certificate	CML 19 ATEX 1178U
Marking	Ex II 2 G Ex db eb IIC Gb

Intrinsically safe variants

Marking	Ex II 1 G Ex ia IIC Ga
Voltage U _i	LED 28 V / Switch 30 V
Current I _i	LED 93 mA / Switch 100 mA
Power P _i	LED 0.651 W / Switch 1 W
Internal capacitance C _i	LED 0.01 µF / Switch 0 µF
Internal inductance L _i	LED 2.2 mH / Switch 0mH

International approvals

IECEX approval	IECEX CML 19.0054U
----------------	--------------------

Conformity

Degree of protection	EN 60529
Usage category	IEC / EN 60947-3
CE marking	2829

LED Modules - Technical Data

General information

Supplementary information	EC-Type Examination Certificate, Statement of Conformity, Declaration of Conformity, Attestation of Conformity and instructions have to be observed where applicable. For information see www.pepperl-fuchs.com .
---------------------------	--

Control Switches Actuator Heads

Control Switch Actuator Heads								
Type	Function	Diameter [mm]	Switching configuration	Switching diagram	Operator action	Labeling	Lockable	Image
CFP.N6	rotary actuator	39	2 position changeover with left OFF		L - L	0 - I	-	
CFP.N7	rotary actuator	39	2 position changeover		L - L	I - II	-	
CFP.N8	rotary actuator	39	3 position changeover with center OFF		L - L - L	I - 0 - II	-	
CFP.N8S	rotary actuator	39	3 position changeover with center OFF		S - L - S	I - 0 - II	-	
CFP.N9	rotary actuator	39	3 position changeover with left OFF		L - L - L	0 - I - II	-	
CFP.S6	rotary actuator	60	2 position changeover with left OFF		L - L	0 - I	yes	
CFP.S7	rotary actuator	60	2 position changeover		L - L	I - II	-	
CFP.S8	rotary actuator	60	3 position changeover with center OFF		L - L - L	I - 0 - II	yes	
CFP.S8S	rotary actuator	60	3 position changeover with center OFF		S - L - S	I - 0 - II	yes	
CFP.S9	rotary actuator	60	3 position changeover with left OFF		L - L - L	0 - I - II	yes	
CFP.K6	key switch rotary actuator	39	2 position changeover with left OFF		L - L	0 - I	yes	
CFP.K6S	key switch rotary actuator	39	2 position changeover with left OFF		L - S	0 - I	yes	
CFP.K8	key switch rotary actuator	39	3 position changeover with center OFF		L - L - L	I - 0 - II	yes	
CFP.K8S	key switch rotary actuator	39	3 position changeover with center OFF		S - L - S	I - 0 - II	yes	

Operator action: L = latching, S = spring return

Control Switches Actuator Heads

Actuator Heads - Dimensions

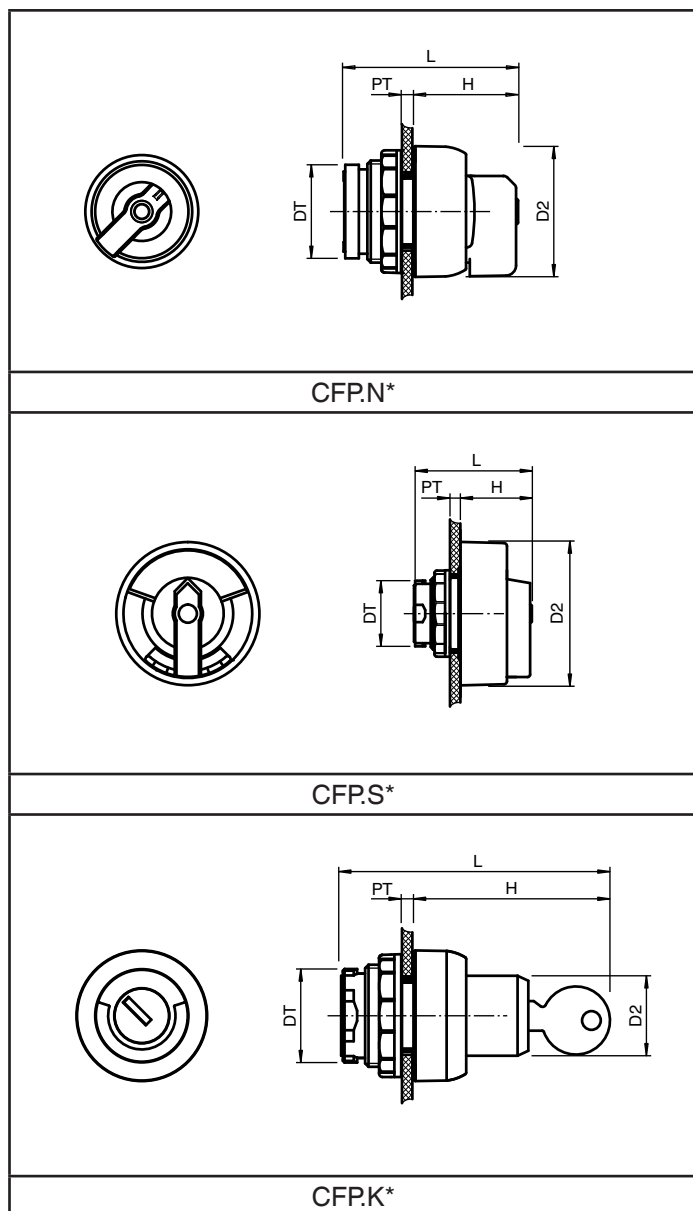

Actuator Heads - Technical Data

Mechanical specifications

Dimensions	see data table
Mounting	use with base-mounted and lid-mounted contact modules
Degree of protection	IP66
Mass	see data table

Material

Housing	Polyamide (PA)
Finish	inherent color black
Washer gasket	silicone

Ambient conditions

Ambient temperature	-40 ... 55 °C (-40 ... 131 °F)
Service temperature	-40 ... 65 °C (-40 ... 149 °F)

Data for application in connection with hazardous areas

EU-Type Examination Certificate	CML 16 ATEX 3339U
Marking	II 2 GD Ex e IIC Gb Ex tb IIIC Db

International approvals

IECEX approval	IECEX CML 16.0114U
----------------	--------------------

Conformity

Degree of protection	EN 60529
CE marking	2829

General information

Supplementary information	EC-Type Examination Certificate, Statement of Conformity, Declaration of Conformity, Attestation of Conformity and instructions have to be observed where applicable. For information see www.pepperl-fuchs.com .
---------------------------	--

Type	Actuator head diameter [mm]	Panel wall thickness [mm]	Diameter thru-hole [mm]	Length outside enclosure [mm]	Total length [mm]	Mass [g]	Image example
	D2	PT	DT	H	L		
CFP.N*	39	1 ... 6	30.6	30.5	50.5	30	
CFP.S*	60	1 ... 6	30.6	30.5	50.5	46	
CFP.K*	39	1 ... 6	30.6	49.5	70	46	

Refer to "General Notes Relating to Pepperl+Fuchs Product Information".

Pepperl+Fuchs Group
www.pepperl-fuchs.comUSA: +1 330 486 0002
pa-info@us.pepperl-fuchs.comGermany: +49 621 776 2222
pa-info@de.pepperl-fuchs.comSingapore: +65 6779 9091
pa-info@sg.pepperl-fuchs.com





Control Switches, 2 Pole Contact Blocks

Combination of 2 Pole Contact Blocks and Actuator Heads

Actuator head function	Actuator head diameter [mm]	Switching configuration	Contact block	Contacts	Switching diagram see overview	Operator action	Labeling	Lockable	Actuator type
rotary actuator	39	2 position changeover with left OFF	O	2x NO	(1)	L - L	0 - I	-	N6
rotary actuator	39	2 position changeover	M	1x NO / 1x NC	(2)	L - L	I - II	-	N7
rotary actuator	39	3 position changeover with center OFF	O	2x NO	(4)	L - L - L	I - 0 - II	-	N8
rotary actuator	39	3 position changeover with center OFF	O	2x NO	(4)	S - L - S	I - 0 - II	-	N8S
rotary actuator	39	3 position changeover with left OFF	M	1x NO / 1x NC	(3)	L - L - L	0 - I - II	-	N9
rotary actuator	60	2 position changeover with left OFF	O	2x NO	(1)	L - L	0 - I	yes	S6
rotary actuator	60	2 position changeover	M	1x NO / 1x NC	(2)	L - L	I - II	-	S7
rotary actuator	60	3 position changeover with center OFF	O	2x NO	(4)	L - L - L	I - 0 - II	yes	S8
rotary actuator	60	3 position changeover with center OFF	O	2x NO	(4)	S - L - S	I - 0 - II	yes	S8S
rotary actuator	60	3 position changeover with left OFF	M	1x NO / 1x NC	(3)	L - L - L	0 - I - II	yes	S9
key switch rotary actuator	39	2 position changeover with left OFF	O	2x NO	(1)	L - L	0 - I	yes	K6
key switch rotary actuator	39	2 position changeover with left OFF	O	2x NO	(1)	L - S	0 - I	yes	K6S
key switch rotary actuator	39	3 position changeover with center OFF	O	2x NO	(4)	L - L - L	I - 0 - II	yes	K8
key switch rotary actuator	39	3 position changeover with center OFF	O	2x NO	(4)	S - L - S	I - 0 - II	yes	K8S

Operator action: L = latching, S = spring return

Contact Blocks

Type	Mounting	Number of poles	Contact configuration	Switching diagram	Image
CFPM	base-mounted	2	1x NO / 1x NC		
CFPC	base-mounted	2	2x NC		
CFPO	base-mounted	2	2x NO		

Refer to "General Notes Relating to Pepperl+Fuchs Product Information".

Pepperl+Fuchs Group
www.pepperl-fuchs.comUSA: +1 330 486 0002
pa-info@us.pepperl-fuchs.comGermany: +49 621 776 2222
pa-info@de.pepperl-fuchs.comSingapore: +65 6779 9091
pa-info@sg.pepperl-fuchs.com PEPPERL+FUCHS

Control Switches, 2 Pole Contact Blocks

Switching Diagrams

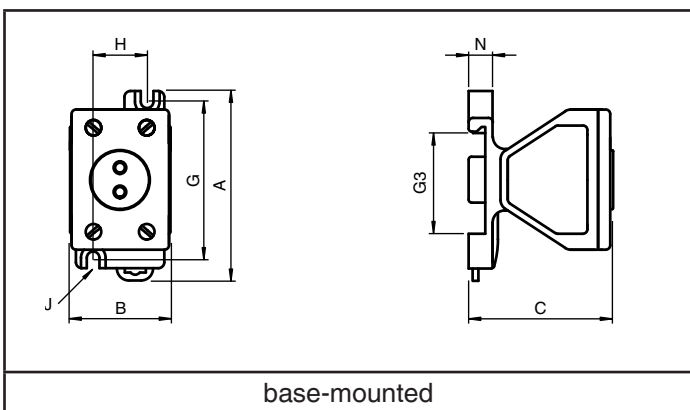
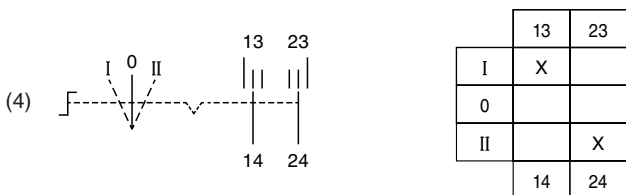
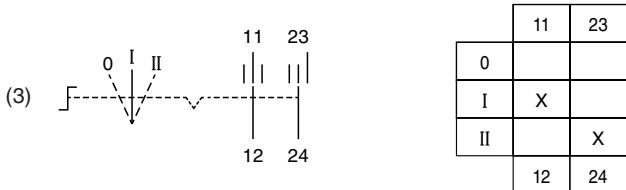
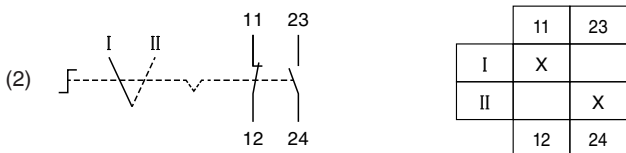
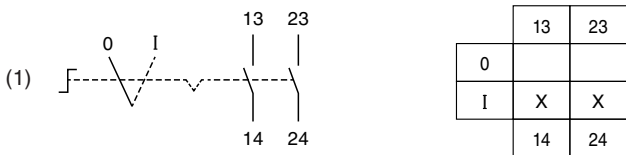

Contact Blocks - Technical Data

Electrical specifications

Operating voltage	250 V max.
Operating current	16 A max.
Terminal capacity	2.5 mm ²
Terminal torque	0.8 Nm
Usage category	AC12: 12 ... 250 V AC - 16 A AC15: 12 ... 250 V AC - 10 A DC13: 12 ... 110 V DC - 1 A DC13: 12 ... 24 V DC - 1 A

Mechanical specifications

Mechanical life	1000000 switching operations
Degree of protection	IP20

Material

Housing	Polyamide (PA)
---------	----------------

Ambient conditions

Service temperature	-40 ... 90 °C (-40 ... 194 °F)
---------------------	--------------------------------

Data for application in connection with hazardous areas

EU-Type Examination Certificate	CML 16 ATEX 3339U
Marking	⚠ II 2 G Ex de IIC Gb

International approvals

IECEx approval	IECEx CML 16.0114U
----------------	--------------------

Conformity

Degree of protection	EN 60529
Usage category	IEC / EN 60947
CE marking	2829

General information

Supplementary information	EC-Type Examination Certificate, Statement of Conformity, Declaration of Conformity, Attestation of Conformity and instructions have to be observed where applicable. For information see www.pepperl-fuchs.com .
---------------------------	--

Contact Blocks - Dimensions

Mounting	External dimension [mm]			Mounting holes [mm]			Mounting brackets [mm]	DIN mounting rail receptacle [mm]	Mass [g]	Enclosure type
	A	B	C	G	H	Diam. J				
base-mounted	63	33.4	50	52	18	4.2	8	35.6	68	GR.CS* SR.CS*

Release date: 2026-03-11 Date of issue: 2026-03-11 Filename: t189602_eng.pdf

Refer to "General Notes Relating to Pepperl+Fuchs Product Information".

Control Switches, 4 Pole Contact Blocks

Combination of 4 Pole Contact Blocks and Actuator Heads

Actuator head function	Actuator head diameter [mm]	Switching configuration	Contact block	Contacts	Switching diagram see overview	Operator action	Labeling	Lockable	Actuator type
rotary actuator	60	2 position changeover with left OFF	03	4x NO	(5)	L - L	0 - I	yes	S6
rotary actuator	60	2 position changeover	01	2x NO / 2x NC	(6)	L - L	I - II	-	S7
rotary actuator	60	3 position changeover with center OFF	03	4x NO	(7)	L - L - L	I - 0 - II	yes	S8
rotary actuator	60	3 position changeover with center OFF	03	4x NO	(7)	S - L - S	I - 0 - II	yes	S8S

Operator action: L = latching, S = spring return

Contact Blocks

Type	Mounting	Number of poles	Contact configuration	Switching diagram	Image
CFP.01	base-mounted	4	2x NO / 2x NC		
CFP.02	base-mounted	4	4x NC		
CFP.03	base-mounted	4	4x NO		
CFP.04	base-mounted	4	1x NO / 3x NC		
CFP.05	base-mounted	4	3x NO / 1x NC		

Resistor Contact Blocks

Type	Mounting	Number of poles	Contact configuration	Switching diagram	Image
CFP.RM	base-mounted	2	1x NO / 1x NC		
CFP.RO	base-mounted	2	2x NC		
CFP.RC	base-mounted	2	2x NO		

Control Switches, 4 Pole Contact Blocks

Switching Diagrams

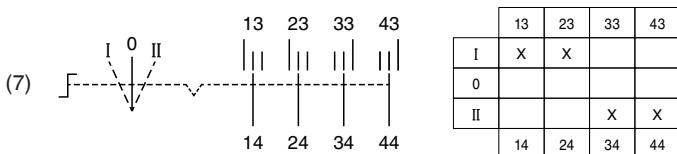
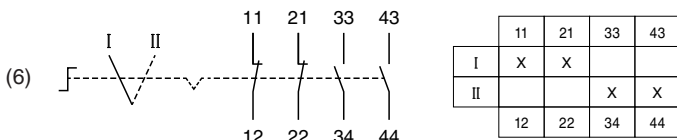
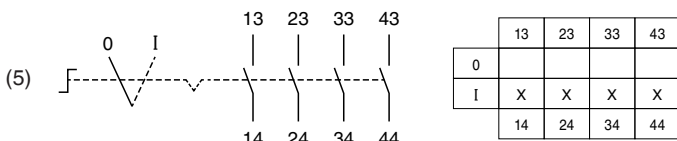

Contact Blocks - Technical Data

Electrical specifications

Operating voltage	250 V max.
Operating current	16 A max.
Terminal capacity	2.5 mm ²
Terminal torque	0.8 Nm

Usage category	AC12: 12 ... 250 V AC - 16 A AC15: 12 ... 250 V AC - 10 A DC13: 12 ... 110 V DC - 1 A DC13: 12 ... 24 V DC - 1 A
----------------	---

Mechanical specifications

Mechanical life	1000000 switching operations
Degree of protection	IP20

Material

Housing	Polyamide (PA)
---------	----------------

Ambient conditions

Service temperature	-40 ... 90 °C (-40 ... 194 °F)
---------------------	--------------------------------

Data for application in connection with hazardous areas

EU-Type Examination Certificate	CML 16 ATEX 3339U
---------------------------------	-------------------

Marking	II 2 G Ex de IIC Gb
---------	------------------------

International approvals

IECEx approval	IECEx CML 16.0114U
----------------	--------------------

Conformity

Degree of protection	EN 60529
Usage category	IEC / EN 60947
CE marking	2829

General information

Supplementary information	EC-Type Examination Certificate, Statement of Conformity, Declaration of Conformity, Attestation of Conformity and instructions have to be observed where applicable. For information see www.pepperl-fuchs.com .
---------------------------	--

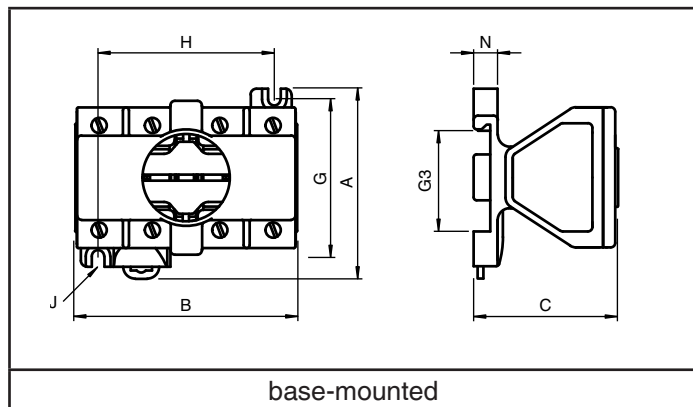

Contact Blocks - Dimensions

Mounting	External dimension [mm]			Mounting holes [mm]			Mounting brackets [mm]	DIN mounting rail receptacle [mm]	Mass [g]	Enclosure type
	A	B	C	G	H	Diam. J				
base-mounted	63	74	58.6	52	58	4.2	8	35.6	165	GR.CS* SR.CS*

Release date: 2026-03-11 Date of issue: 2026-03-11 Filename: 1189602_eng.pdf

Refer to "General Notes Relating to Pepperl+Fuchs Product Information".

Control Switches, 4 Pole Rotary Switching Blocks

Combination of 4 Pole Rotary Switching Blocks and Actuator Heads							
Switching configuration	Switching block	Contacts	Switching diagram see overview	Operator action	Labeling	Lockable	Actuator type
2 position changeover, left OFF	10	4x NO	(10)	L - L	0 - I	yes	T6
2 position changeover	11	2x NO / 2x NC	(11)	L - L	I - II	-	T7
2 position changeover	17	3x NO / 1x NC	(17)	L - L	I - II	-	T7
2 position changeover	18	1x NO / 3x NC	(18)	L - L	I - II	-	T7
3 position changeover, center OFF	12	4x NO	(12)	L - L - L	I - 0 - II	yes	T8
3 position changeover, center OFF	14	4x NO	(14)	L - L - L	I - 0 - II	yes	T8
3 position changeover, center OFF, both sides spring return	13	4x NO	(13)	S - L - S	I - 0 - II	yes	T8
3 position changeover	22	4x NO	(22)	L - L - L	I - 0 - II	-	T8
3 position changeover	23	4x NO	(23)	L - L - L	0 - I - II	-	T0
3 position changeover, right spring return	19	2x NO / 2x NC	(19)	L - L - S	0 - I - II	-	T0
3 position changeover, right spring return	16	3x NO / 1x NC	(16)	L - L - S	0 - I - II	-	T0
4 position changeover	15	3x NO / 1x NC	(15)	L - L - L - L	I - II - III - IV	-	T9
4 position changeover, right spring return	20	4x NO	(20)	L - L - L - S	I - II - III - IV	-	T9
4 position changeover	21	4x NO	(21)	L - L - L - L	I - II - III - IV	-	T9

Operator action: L = latching, S = spring return

Control Switches, 4 Pole Rotary Switching Blocks

Dimensions

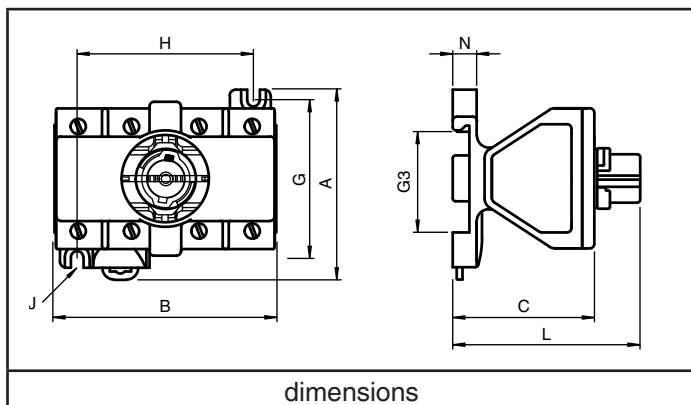
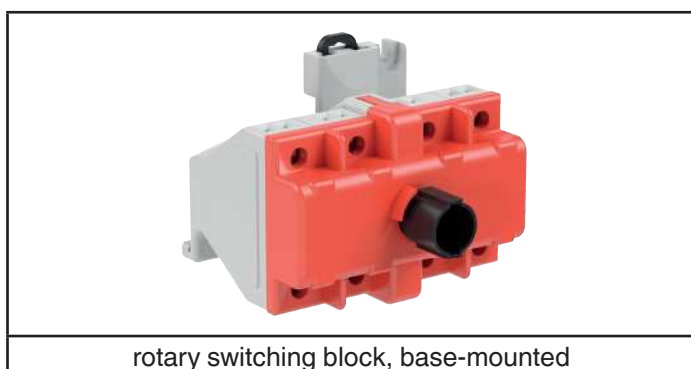

Switching Blocks - Technical Data

Electrical specifications

Operating voltage	250 V max.
Operating current	16 A max.
Terminal capacity	2.5 mm ²
Terminal torque	0.8 Nm
Usage category	AC12: 12 ... 250 V AC - 16 A AC15: 12 ... 250 V AC - 10 A DC13: 12 ... 110 V DC - 1 A DC13: 12 ... 24 V DC - 1 A

Mechanical specifications

Mechanical life	1000000 switching operations
Degree of protection	IP20

Material

Housing	Polyamide (PA)
---------	----------------

Ambient conditions

Service temperature	-40 ... 90 °C (-40 ... 194 °F)
---------------------	--------------------------------

Data for application in connection with hazardous areas

EU-Type Examination Certificate	CML 16 ATEX 3339U
Marking	II 2 G Ex de IIC Gb

International approvals

IECEx approval	IECEx CML 16.0114U
----------------	--------------------

Conformity

Degree of protection	EN 60529
Usage category	IEC / EN 60947
CE marking	2829

General information

Supplementary information	EC-Type Examination Certificate, Statement of Conformity, Declaration of Conformity, Attestation of Conformity and instructions have to be observed where applicable. For information see www.pepperl-fuchs.com .
---------------------------	--

Switching Blocks - Dimensions



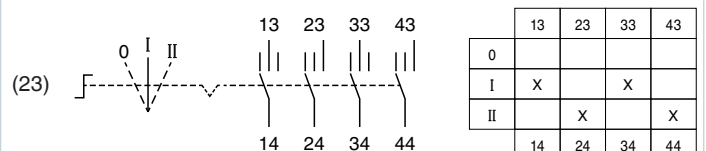
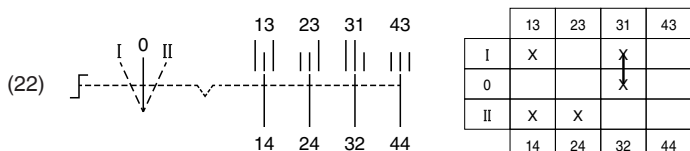
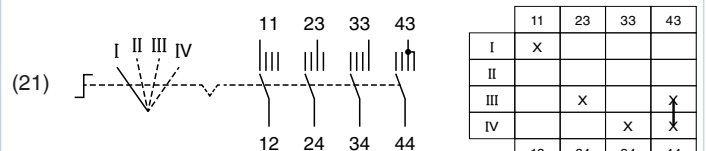
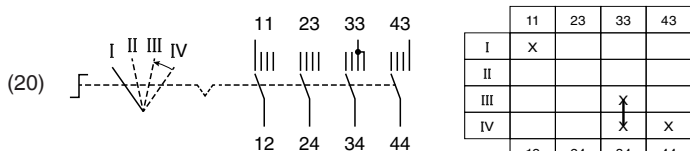
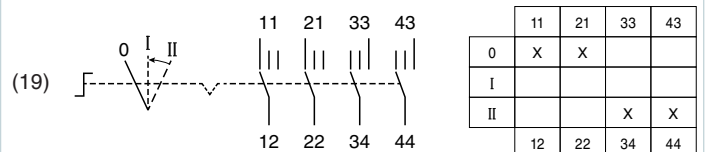
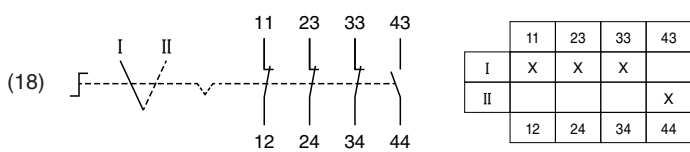
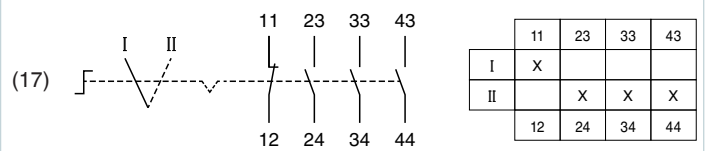
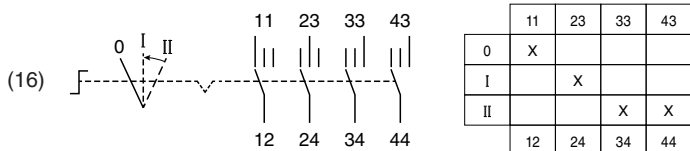
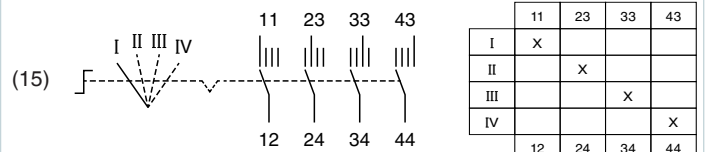
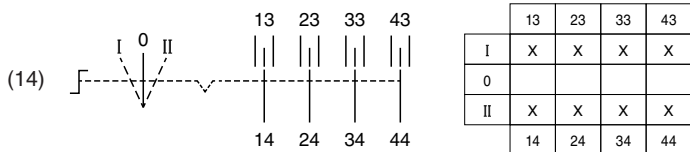
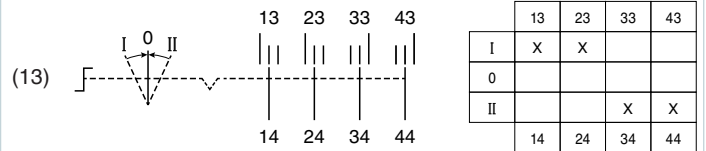
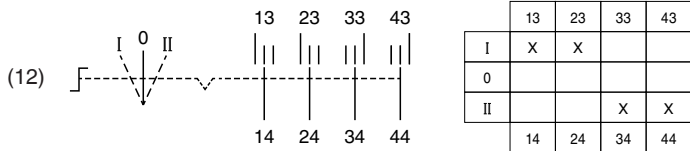
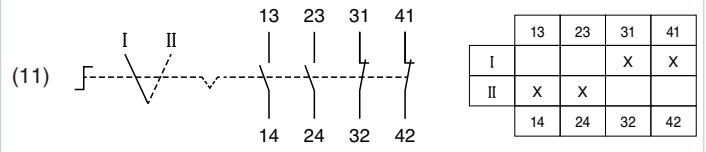
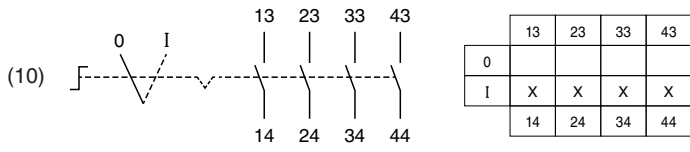

Mounting	External dimension [mm]			Mounting holes [mm]			Mounting brackets [mm]	DIN mounting rail receptacle [mm]	Mass [g]	Enclosure type
	A	B	C	G	H	Diam. J				
base-mounted	63	74	72	52	58	4.2	8	35.6	171	GR.CS* SR.CS*

Control Switches, 4 Pole Rotary Switching Blocks, Switching diagrams



Release date: 2026-03-11 Date of issue: 2026-03-11 Filename: t189602_eng.pdf

LED Indicators

LED Indicators Lenses		
Type	Lens color	Image
CFP.LR	red	
CFP.LG	green	
CFP.LO	amber	
CFP.LW	white	
CFP.LB	blue	

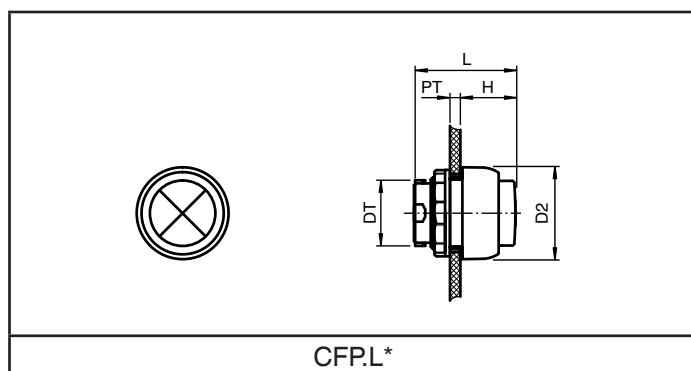

LED Heads - Technical Data

LED Heads - Technical Data	
Mechanical specifications	
Degree of protection	IP66
Material	
Housing	Polyamide (PA)
Finish	inherent color black
Washer gasket	silicone
Ambient conditions	
Ambient temperature	-40 ... 55 °C (-40 ... 131 °F)
Service temperature	-40 ... 65 °C (-40 ... 149 °F)
Data for application in connection with hazardous areas	
EU-Type Examination Certificate	CML 16 ATEX 3339U
Marking	 II 2 GD Ex e IIC Gb Ex tb IIIC Db
International approvals	
IECEX approval	IECEX CML 16.0114U
Conformity	
Degree of protection	EN 60529
CE marking	2829
General information	
Supplementary information	EC-Type Examination Certificate, Statement of Conformity, Declaration of Conformity, Attestation of Conformity and instructions have to be observed where applicable. For information see www.pepperl-fuchs.com .

LED Heads - Dimensions

Diameter [mm]	Panel wall thickness [mm]	Diameter thru-hole [mm]	Length outside enclosure [mm]	Total length [mm]	Mass [g]	Mounting	Enclosure type
D2	PT	DT	H	L			
39	1 ... 6	30.6	23.6	43	20	use with base-mounted and cover-mounted LED modules	LC*, LR* FXL*.CS GR.CS* SR.CS*

LED Indicators

LED Modules

Type	Mounting	Rated operating voltage [V AC/DC]	Image
CFP.NI	base-mounted	10 ... 30, Ex ia	
CFP.NE	base-mounted	10 ... 28	
CFP.L	base-mounted	20 ... 250	

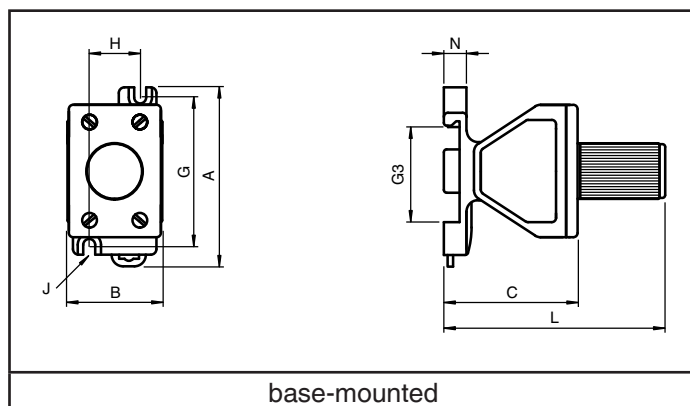

LED Modules - Technical Data

Electrical specifications

Operating voltage	250 V max.
Power consumption	2 W max.
Terminal capacity	2.5 mm ²
Terminal torque	0.8 Nm

Mechanical specifications

Degree of protection	IP20
----------------------	------

Material

Housing	Polyamide (PA)
---------	----------------

Ambient conditions

Service temperature	-40 ... 90 °C (-40 ... 194 °F)
---------------------	--------------------------------

Data for application in connection with hazardous areas

EU-Type Examination Certificate	CML 16 ATEX 3339U
---------------------------------	-------------------

Marking	 II 2 G Ex de IIC Gb
---------	--

Intrinsically safe variants *.NI, *.GI

Marking	 II 1 G Ex ia IIC Ga
---------	--

Voltage U _i	28 V
Current I _i	93 mA
Power P _i	0.651 W
Internal capacitance C _i	0 µF
Internal inductance L _i	0 mH

International approvals

IECEx approval	IECEx CML 16.0114U
----------------	--------------------

Conformity

Degree of protection	EN 60529
CE marking	2829

General information

Supplementary information	EC-Type Examination Certificate, Statement of Conformity, Declaration of Conformity, Attestation of Conformity and instructions have to be observed where applicable. For information see www.pepperl-fuchs.com .
---------------------------	--

LED Modules - Dimensions



Mounting	External dimension [mm]				Mounting holes [mm]			Mounting brackets [mm]	DIN rail receptacle [mm]	Mass [g]	Enclosure type
	A	B	C	L	G	H	Diam. J				
base-mounted	63	33.4	47	84	52	18	4.2	8	35.6	61	LC*, LR* GR.CS* SR.CS*

Refer to "General Notes Relating to Pepperl+Fuchs Product Information".

Pepperl+Fuchs Group
www.pepperl-fuchs.comUSA: +1 330 486 0002
pa-info@us.pepperl-fuchs.comGermany: +49 621 776 2222
pa-info@de.pepperl-fuchs.comSingapore: +65 6779 9091
pa-info@sg.pepperl-fuchs.com PEPPERL+FUCHS

Buzzer

Buzzer Modules

Type	Function	Color	Rated operating voltage [V AC/DC]	Image
CFP. BUZRF1	flashing buzzer	red	10 ... 28	
CFP. BUZRF2	flashing buzzer	red	30 ... 250	
CFP. BUZKS1	buzzer	black	10 ... 28	
CFP. BUZKS2	buzzer	black	30 ... 250	

Buzzer - Technical Data

Electrical specifications

Operating voltage	250 V max.
Power consumption	1 W max.
Terminal capacity	2.5 mm ²
Terminal torque	0.8 Nm
Sound level	60 dB at 30 cm

Mechanical specifications

Degree of protection	IP66
----------------------	------

Material

Housing	Polyamide (PA)
---------	----------------

Ambient conditions

Ambient temperature	-40 ... 50°C (-40 ... 122 °F)
Service temperature	-40 ... 90 °C (-40 ... 194 °F)

Data for application in connection with hazardous areas

EU-Type Examination Certificate	EPT 16 ATEX 2404U
---------------------------------	-------------------

Marking	 II 2 GD Ex eb ib mb IIC Gb Ex ib tb IIIC Db
---------	---

International approvals

IECEx approval	IECEx EUT 16.0011U
----------------	--------------------

Conformity

Degree of protection	EN 60529
CE marking	2460

General information

Supplementary information	EC-Type Examination Certificate, Statement of Conformity, Declaration of Conformity, Attestation of Conformity and instructions have to be observed where applicable. For information see www.pepperl-fuchs.com .
---------------------------	--

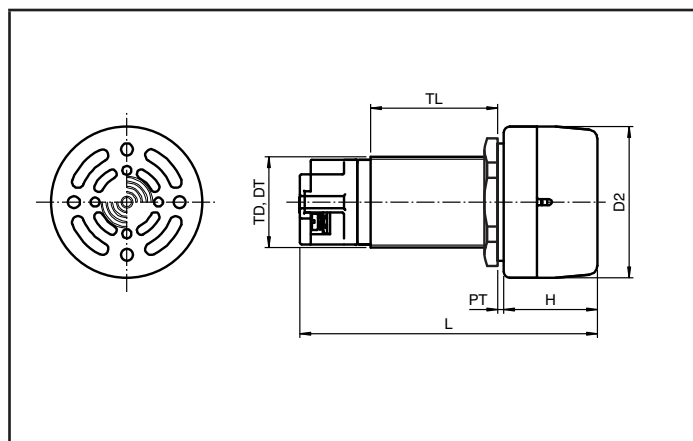

Buzzer - Dimensions

Actuator head diameter [mm]	Panel wall thickness [mm]	Diameter thru-hole [mm]	Length outside enclosure [mm]	Total length [mm]	Thread size	Thread length [mm]	Mass [g]	Mounting	Enclosure type
D2	PT	DT	H	L	TD	TL			
50	1 ... 35	30.6	31	98.5	M30 x 1.5	42	125	cover-mounted	LC*, LR* GR.CS* SR.CS* FXL*.CS

Ammeters

Ammeter Modules

Type	Rated operating current	Scales see table	Image
CFP.AA	0 ... 1 A	scale per specification	
CFP.AB	0 ... 5 A	scale per specification	
CFP.AC	4 ... 20 mA	scale 4 ... 20 / 40 mA	
CFP.AD	0 ... 20 mA	scale 0 ... 20 / 40 mA	

Ammeter Scales

Scales	Type Code	Scales	Type Code
0 ... 1 / 5 A	SA	0 ... 150 / 750 A	SM
0 ... 2.5 / 12.5 A	SB	0 ... 200 / 1000 A	SN
0 ... 5 / 25 A	SC	0 ... 250 / 1250 A	SO
0 ... 10 / 50 A	SD	0 ... 300 / 1500 A	SP
0 ... 15 / 75 A	SE	0 ... 400 / 2000 A	SQ
0 ... 20 / 100 A	SU	0 ... 500 / 2500 A	SR
0 ... 25 / 125 A	SF	0 ... 600 / 3000 A	SS
0 ... 30 / 150 A	SG	0 ... 1000 / 5000 A	ST
0 ... 40 / 200 A	SH	Scale as per specification	SZ
0 ... 50 / 250 A	SI		
0 ... 60 / 300 A	SJ		
0 ... 75 / 375 A	SK		
0 ... 100 / 500 A	SL		

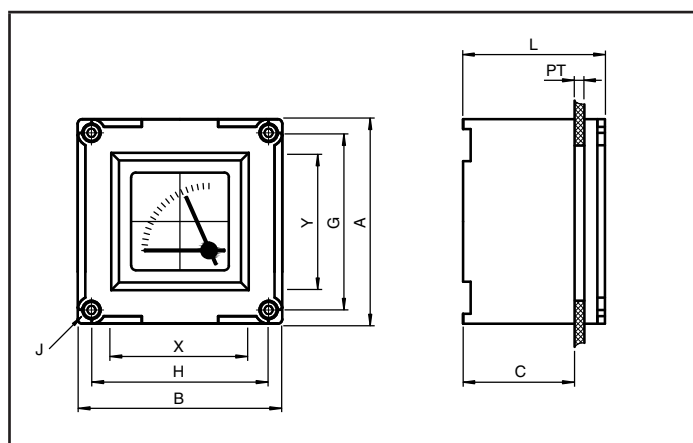

Ammeter Modules - Dimensions

External dimension [mm]				Viewing window [mm]		Panel wall thickness [mm]	Mounting holes [mm]			Mass [g]	Enclosure type
A	B	C	L	X	Y	PT	G	H	Diam. J		
70	70	59	75	54	50	1 ... 6	63	63	3.5	186	LC*, LR* FXL*.CS, SR.CS* GR.CS

Ammeter Modules - Technical Data

Electrical specifications

Operating voltage	500 V AC
Operating current	5 A max.
Accuracy class	1.5
Terminal capacity	2.5 mm ²
Terminal torque	0.8 Nm

Mechanical specifications

Degree of protection	IP66
Mounting	Meter window mounting kit

Material

Housing	Polyamide (PA)
---------	----------------

Ambient conditions

Service temperature	-40 ... 95 °C (-40 ... 203 °F)
---------------------	--------------------------------

Data for application in connection with hazardous areas

EU-Type Examination Certificate	CML 16 ATEX 3339U
Marking	CFP.AA/  II 2 G CFP.AB: Ex e IIC Gb
	CFP.AC/  II 2 G CFP.AD: Ex e mb IIC Gb

International approvals

IECEX approval	IECEX CML 16.0114U
----------------	--------------------

Conformity

Degree of protection	EN 60529
CE marking	2829

General information

Supplementary information	EC-Type Examination Certificate, Statement of Conformity, Declaration of Conformity, Attestation of Conformity and instructions have to be observed where applicable. For information see www.pepperl-fuchs.com .
---------------------------	--

Meter Window Mounting Kits

Type	Window including	Enclosure type
CFP.WB	base mounting kit	L*, GR.CS*
CFP.WL	cover mounting kit	FXL*.CS, SR.CS*

Voltmeters

Voltmeter Modules

Type	Rated operating voltage	Image
CFP.V6	0 ... 10 V	
CFP.V1	0 ... 25 V	
CFP.V2	0 ... 40 V	
CFP.V7	0 ... 50 V	
CFP.V8	0 ... 100 V	
CFP.V9	0 ... 120 V	
CFP.V3	0 ... 150 V	
CFP.V4	0 ... 250 V	
CFP.V5	0 ... 500 V	

Voltmeter Scales

included in module

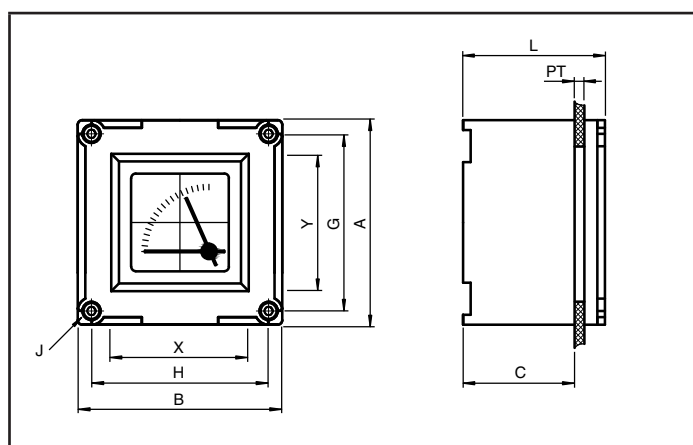

Voltmeter Modules - Dimensions

External dimension [mm]				Viewing window [mm]		Panel wall thickness [mm]	Mounting holes [mm]			Mass [g]	Enclosure type
A	B	C	L	X	Y	PT	G	H	Diam. J		
70	70	59	75	54	50	1 ... 6	63	63	3.5	186	LC*, LR* FXL*.CS, SR.CS* GR.CS*

Voltmeter Modules - Technical Data

Electrical specifications

Operating voltage	500 V AC
Accuracy class	1.5
Terminal capacity	2.5 mm ²
Terminal torque	0.8 Nm

Mechanical specifications

Degree of protection	IP66
Mounting	Meter window mounting kit

Material

Housing	Polyamide (PA)
---------	----------------

Ambient conditions

Service temperature	-40 ... 95 °C (-40 ... 203 °F)
---------------------	--------------------------------

Data for application in connection with hazardous areas

EU-Type Examination Certificate	CML 16 ATEX 3339U
Marking	 II 2 G Ex e mb IIC Gb

International approvals

IECEX approval	IECEX CML 16.0114U
----------------	--------------------

Conformity

Degree of protection	EN 60529
CE marking	2829

General information

Supplementary information	EC-Type Examination Certificate, Statement of Conformity, Declaration of Conformity, Attestation of Conformity and instructions have to be observed where applicable. For information see www.pepperl-fuchs.com .
---------------------------	--

Meter Window Mounting Kits

Type	Window including	Enclosure type
CFP.WB	base mounting kit	L*, GR.CS*
CFP.WL	cover mounting kit	FXL*.CS, SR.CS*

Potentiometers

Potentiometer Actuator Heads

Type	Enclosure type	Labeling	Image
CFP.R2	GR.CS*	0 ... 10	

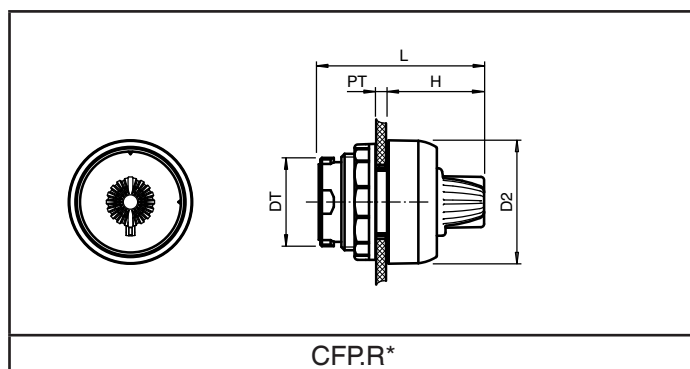

Actuator Heads - Technical Data

Mechanical specifications

Degree of protection IP66

Material

Housing Polyamide (PA)

Finish inherent color black

Washer gasket silicone

Ambient conditions

Ambient temperature -40 ... 55 °C (-40 ... 131 °F)

Service temperature -40 ... 65 °C (-40 ... 149 °F)

Data for application in connection with hazardous areas

EU-Type Examination Certificate CML 16 ATEX 3339U

Marking  II 2 GD
Ex e IIC Gb
Ex tb IIIC Db

International approvals

IECEX approval IECEX CML 16.0114U

Conformity

Degree of protection EN 60529

CE marking 2829

General information

Supplementary information EC-Type Examination Certificate, Statement of Conformity, Declaration of Conformity, Attestation of Conformity and instructions have to be observed where applicable. For information see www.pepperl-fuchs.com.

Potentiometer Actuator Heads - Dimensions

Actuator head diameter [mm]	Panel wall thickness [mm]	Diameter thru-hole [mm]	Length outside enclosure [mm]	Total length [mm]	Mass [g]	Mounting
D2	PT	DT	H	L		
39	1 ... 6	30.6	30.5	50.5	27	use with base-mounted and cover-mounted potentiometer modules

Potentiometers

Potentiometer Modules

Type	Mounting	Range [kΩ]	Image
CFP.3	base-mounted	0 ... 0.5	
CFP.1	base-mounted	0 ... 1	
CFP.2	base-mounted	0 ... 2	
CFP.5	base-mounted	0 ... 5	
CFP.0	base-mounted	0 ... 10	

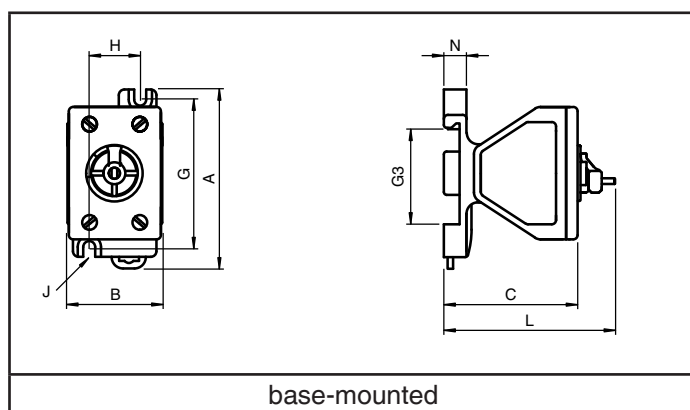

Potentiometer Modules - Technical Data

Electrical specifications

Operating voltage	200 V max.
Power consumption	0.1 W max.
Terminal capacity	2.5 mm ²
Terminal torque	0.8 Nm

Mechanical specifications

Degree of protection	IP20
----------------------	------

Material

Housing	Polyamide (PA)
---------	----------------

Ambient conditions

Service temperature	-55 ... 90 °C (-67 ... 194 °F)
---------------------	--------------------------------

Data for application in connection with hazardous areas

EU-Type Examination Certificate	CML 16 ATEX 3339U
---------------------------------	-------------------

Marking	 II 2 G Ex de IIC Gb
---------	--

International approvals

IECEx approval	IECEx CML 16.0114U
----------------	--------------------

Conformity

Degree of protection	EN 60529
CE marking	2829







General information







Supplementary information	EC-Type Examination Certificate, Statement of Conformity, Declaration of Conformity, Attestation of Conformity and instructions have to be observed where applicable. For information see www.pepperl-fuchs.com .
---------------------------	--

Potentiometer Modules - Dimensions

Mounting	External dimension [mm]				Mounting holes [mm]			Mounting brackets [mm]	DIN rail receptacle [mm]	Mass [g]	Enclosure type
	A	B	C	L	G	H	Diam. J				
base-mounted	63	34	50	60	52	18	4.2	8	35.6	69	GR.CS* SR.CS*

Operating Elements Accessories

Accessory		
Type	Description	Image
CFP.BK	Blanking plug	
CFP.ZT	Extra small label holder with printed label as per specification	
CFP.ZS	Small label holder with printed label as per specification	
CFP.ZL	Large label holder with printed label as per specification	
CFP.ZEB	Emergency stop label, yellow, round	
CFP.ZEB.V2	Emergency stop label, yellow, round, engraved NOT HALT EMERGENCY STOP	
CFP.TP	Locknut spanner, plastic	

Accessory		
Type	Description	Image
CFP.ZB CFP.ZBR (1) (8)	Protective flap for small actuators, plastic, padlockable	
CFP.ZJ CFP.ZJR (1) (8)	Protective pushbutton flap with continuous operation, plastic, padlockable	
CFP.ZA CFP.ZAR (4) (8) (9)	Protective flap, plastic	
CFP.ZP CFP.ZPR (5) (8)	Emergency stop shroud, plastic, padlockable, supplied with padlock and 2 keys	
CFP.ZCT (6) (9)	Protective flap, stainless steel	
CFP.ZDT (7)	Protective flap, stainless steel, padlockable	

- (1) CFP.ZB* are designed for use with CFP.P* pushbuttons, CFP.I* illuminated pushbuttons, CFP.N* small switches, CFP.R* potentiometer actuators
- (2) CFP.ZJ* are designed for use with CFP.P* pushbuttons
- (3) CFP.ZH is designed for use with CFP.D* double pushbuttons
- (4) CFP.ZA* are designed for use with CFP.S* large switches, CFP.E* emergency stops
- (5) CFP.ZP* are designed for use with CFP.E4 emergency stop buttons, the shroud can either be used without the bar to avoid accidental operation or with the bar to padlock in the operated position
- (6) CFP.ZCT is designed for use with both CFP.E4 and CFP.E5 emergency stop buttons
- (7) CFP.ZDT is designed for use with both CFP.E4 and CFP.E5 emergency stop buttons. The shroud is used to padlock the emergency stop in the operated position and when not in use, the flap should be left open
- (8) Accessories that have two options, use a R at the end of the typecode for use with rail mounted contact blocks and those without R are used for cover mounted contact blocks only
- (9) Shrouds and flaps potentially prevent free and unimpaired access to an emergency stop button. These products may therefore only be used in applications where their use has been assessed and not found to cause unacceptable risk to health and safety of persons or damage to the protected machinery.