



Control Stations Ex e, Stainless Steel, cover-mounted contact modules

SR.CS*

- Stainless Steel enclosure
- Installation in Zone 1, Zone 2, Zone 21 and Zone 22
- Ex db eb, Ex ib and Ex tb certified
- Up to 102 operators per control station
- 5 enclosure size options
- Return Flange Sealing provides Drain Channel
- Customizable configuration of operators, cable entry quantities and cable gland types as per specification
- Customizable configuration of gland plates, ground bolt and hinges as per specification
- Option for vertical or horizontal mounting provides high flexibility
- Up to 4 gland plates
- Wide range of labels and accessories available

Control Stations Ex e, Stainless Steel, cover-mounted contact modules



Function

The SR series is a flexible range of control stations that are fully customizable. Enclosures can meet the needs of user specifications by being supplied with or without accessories such as cover hinges, mounting brackets or gland plates. A comprehensive range of operating elements, contact blocks, terminals, entry devices and enclosure accessories are available to ensure each configuration will exactly meet any application requirements. Enclosures are manufactured from brushed AISI 316L stainless steel and all fixings are manufactured from A4 grade stainless steel as standard to provide excellent tarnish and corrosion resistance. Your solution can be mounted in portrait or landscape orientation in temperatures ranging from -50°C up to +55 °C. Endless configurations can be confirmed by your local Pepperl+Fuchs office.

Technical Data

Electrical specifications

Operating voltage	400 V AC max.
Operating current	16 A max.
Terminal capacity	2.5 mm ²
Terminal torque	0.8 Nm

Mechanical specifications

Enclosure cover	fully detachable
Cover fixing	stainless steel A4 (V4A) hexagonal head screws , see data table
Cover seal	silicone
Degree of protection	IP66
Cable entry	cable glands as per specification
Gland plate on face(s)	optional
Material	
Enclosure	1.5 mm AISI 316L, (1.4404) stainless steel
Gland plate	optional 3 mm or 6 mm AISI 316L (1.4404) stainless steel
Finish	brushed
Mass	see data table valid for empty enclosure, will increase according to integrated components
Dimensions	see data table
Mounting	screws , optional mounting brackets enclosed
Grounding	M6 internal/external brass nickel-plated grounding bolt M6 internal stainless steel grounding bolt welded to lid M6 internal stainless steel grounding bolt welded to enclosure body

Ambient conditions

Release date: 2022-12-14 Date of issue: 2022-12-14 Filename: t199946_eng.pdf

Refer to "General Notes Relating to Pepperl+Fuchs Product Information".

Pepperl+Fuchs Group
www.pepperl-fuchs.com

USA: +1 330 486 0002
pa-info@us.pepperl-fuchs.com

Germany: +49 621 776 2222
pa-info@de.pepperl-fuchs.com

Singapore: +65 6779 9091
pa-info@sg.pepperl-fuchs.com

PEPPERL+FUCHS

Technical Data

Ambient temperature	-50 ... 55 °C (-58 ... 131 °F) depending on integrated components
Data for application in connection with hazardous areas	
EU-type examination certificate	CML 16 ATEX 3009X
Marking	Ⓢ II 2 GD Ex db eb IIC T* Gb, Ex tb IIIC T** Db or Ex ib IIC T* Gb, Ex tb IIIC T** Db or Ex db eb ib IIC T* Gb, Ex tb IIIC T** Db T6/T80 °C @ Ta +40 °C T5/T95 °C @ Ta +55 °C T4/T130 °C @ Ta +55 °C
International approvals	
IECEX approval	IECEX CML 16.0008X
UKCA approval	CML 21 UKEX 2550X
ECAS approval	22-10-53256/E22-09-052316/NB0002
Conformity	
Degree of protection	EN60529
CE marking	0102
General information	
Ordering information	This device will be delivered completely configured and assembled ready for use. For configuration details please contact Customer Service.
Supplementary information	EC-Type Examination Certificate, Statement of Conformity, Declaration of Conformity, Attestation of Conformity and instructions have to be observed where applicable. For information see www.pepperl-fuchs.com .
Accessories	
Optional accessories	Mounting plate M6 internal/external stainless steel grounding bolt cover hinges stainless steel AISI 316L gland plate 3 mm AISI 316L (1.4404) stainless steel gland plate 6 mm AISI 316L (1.4404) stainless steel M6 internal stainless steel grounding bolt welded to bottom gland plate quarter-turn key locks stainless steel A4 (V4A) engraved traffolyte tag label engraved AISI 316L stainless steel tag label color in-fill stainless steel tag label cover padlock facility
Indicators/operating means	
Control elements	small footprint max. 102 see data table all NC contacts have a direct opening action for emergency stop functions

Assembly

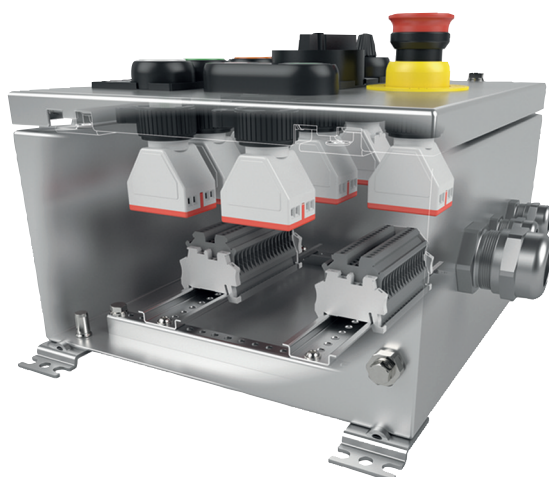

Release date: 2022-12-14 Date of issue: 2022-12-14 Filename: t199946_eng.pdf

Refer to "General Notes Relating to Pepperl+Fuchs Product Information".

Pepperl+Fuchs Group
www.pepperl-fuchs.com

USA: +1 330 486 0002
pa-info@us.pepperl-fuchs.com

Germany: +49 621 776 2222
pa-info@de.pepperl-fuchs.com

Singapore: +65 6779 9091
pa-info@sg.pepperl-fuchs.com

 PEPPERL+FUCHS

Type Code

1	2	3	4	5	6	7	8	9							
SR	.	***	.	**	.	**	.	**	.	*	.	*	-	*	****
SR	.	CSE	.	38	.	48	.	16	.	B	.	1	-	S	0001

Example: SR.CSE.38.48.16.B.1-S0001

Control Station stainless steel, size 38x48x16 cm, landscape orientation with face B at bottom, gland plate at bottom face, standard product

1	Enclosure type
SR	stainless steel
2	Type of solution
CSE	control station (Ex e)
CSI	control station (Ex i)
CSM	control station, various types of explosion protection, e.g. (Ex e, Ex i) or (Ex e, Ex op pr)
3	Height [cm]
n	see dimensions data table
4	Width [cm]
n	see dimensions data table
5	Depth [cm]
n	see dimensions data table
6	Cable entry face orientation
B	face [B] at bottom
D	face [D] at bottom
7	Gland plates
0	none
1	one gland plate at bottom face
2	two gland plates
3	three gland plates
4	four gland plates
8	Variant
S	standard product
C	configured product
CA	configured and adapted product
Y	engineered product
9	Variant number
xxxx	consecutive item number

Dimensions and Enclosure Details

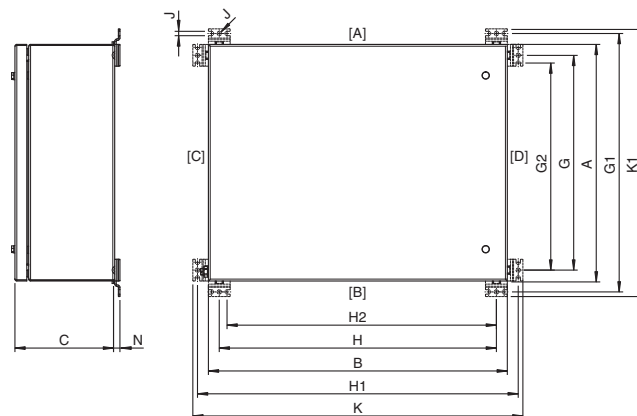

Type	External dimensions [mm]					Mounting [mm]								Mass approx. [kg]	Cover screws		
	A	B	C	K	K1	G	G1	G2	H	H1	H2	J	N		Mx	qty.	Torque [Nm]
SRM.26.26.16	260	260	160	310	310	295	225	212.5	225	295	282.5	7	8.5	5.8	M6	4	3.5
SRM.31.31.16	310	310	160	360	360	345	275	262.5	275	345	332.5	7	8.5	8	M6	4	3.5
SRM.38.48.16	380	480	160	530	430	515	345	332.5	445	415	402.5	7	8.5	12	M6	6	3.5
SRL.48.48.16	480	480	160	530	530	515	445	432.5	445	515	502.5	7	8.5	14	M6	8	3.5
SRL.48.76.16	480	760	160	810	530	795	445	432.5	725	515	502.5	7	8.5	20	M6	8	3.5

Mass is valid for empty enclosure, it will increase according to enclosure accessories, integrated components and entry devices

Control Elements max. Quantity per Enclosure Type

Type	Control elements quantity max.								
	small footprint			large footprint			viewing windows		
	vertical	horizontal	total	vertical	horizontal	total	vertical	horizontal	total
SRM.26.26.16	3	4	12	2	2	4	2	2	4
SRM.31.31.16	3	5	15	3	3	9	3	3	9
SRM.38.48.16	4	10	40	4	5	20	3	5	15
SRL.48.48.16	6	10	60	5	5	25	4	5	20
SRL.48.76.16	6	17	102	5	8	40	4	8	32

Quantities are based on horizontal DIN mounting rails, they may vary with vertical DIN mounting rails

Operating Elements Configuration

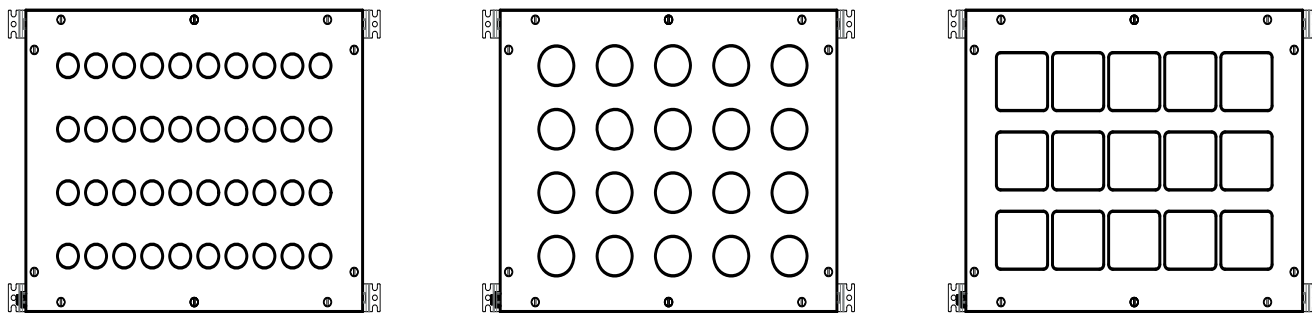

Example based on SR.CSE.38.48.16.B

Left (small footprint):

Small operating elements with small label holder and 2 pole contact blocks

Small operating elements include all pushbuttons, small switching actuators, LED indicators and potentiometers

Middle (large footprint):

Large switching actuators and all operating elements fitted with 4 pole contact modules, protective lid or padlockable shroud

Right:

Viewing windows with ammeter or voltmeter as well as operating elements with large label holders

Notes:























The use of label holders depends on operating elements configuration

The position of the grounding bolt can vary depending on configuration

All NC contacts have a direct opening action for emergency stop functions

For further configurations please contact Pepperl+Fuchs

Pushbuttons and Emergency Stops

Pushbuttons Actuator Heads			
Type	Color	Labeling	Image
CFP.PA	red	none	
CFP.PR	red	0	
CFP.PC	red	STOP	
CFP.PD	red	OFF	
CFP.PE	green	none	
CFP.PG	green	I	
CFP.PI	green	II	
CFP.PF	green	START	
CFP.PH	green	ON	
CFP.PY	yellow	none	
CFP.PO	amber	none	
CFP.PW	white	none	
CFP.PB	blue	none	
CFP.PJ	blue	RESET	
CFP.PK	black	none	
CFP.PL	black	0	
CFP.PN	black	I	
CFP.PP	black	II	
CFP.PQ	black	III	
CFP.PT	black	IV	
CFP.PU	black	arrow up	
CFP.PV	black	arrow down	
CFP.PZ*	see individual datasheets		

Actuator Heads - Technical Data

Mechanical specifications	
Dimensions	see data table
Mounting	use with base-mounted and lid-mounted contact modules
Degree of protection	IP66
Mass	see data table
Material	
Housing	Polyamide (PA)
Finish	inherent color black
Washer gasket	silicone
Ambient conditions	
Ambient temperature	-40 ... 55 °C (-40 ... 131 °F)
Service temperature	-40 ... 65 °C (-40 ... 149 °F)
Data for application in connection with hazardous areas	
EU-Type Examination Certificate	CML 16 ATEX 3339U
Marking	 II 2 GD Ex e IIC Gb Ex tb IIIC Db
International approvals	
IECEX approval	IECEX CML 16.0114U
Conformity	
Degree of protection	EN 60529
CE marking	0102
General information	
Supplementary information	EC-Type Examination Certificate, Statement of Conformity, Declaration of Conformity, Attestation of Conformity and instructions have to be observed where applicable. For information see www.pepperl-fuchs.com .
Enclosure type	LC*, LRS* FXL*.CS, SR.CS* GR.CS*

Pushbuttons and Emergency Stops

Emergency Stops Actuator Heads

Type	Function	Color	Labeling	Operator action	Actuator head diameter	Switching diagram	Image
CFP.E4	mushroom button	red	none	latching, twist to release	40 mm		
CFP.E5	mushroom button	red	none	latching, twist to release	55 mm		
CFP.JR	mushroom button	red	none	latching, key release	39 mm		

Other Pushbuttons Actuator Heads

Type	Function	Color	Labeling	Operator action	Actuator head diameter	Switching diagram	Image
CFP.DM	pushbutton	red / green	0 - I	spring return	70 mm x 39 mm		
CFP.MK	mushroom button	black	none	spring return	39 mm		
CFP.MR	mushroom button	red	none	spring return	39 mm		
CFP.MG	mushroom button	green	none	spring return	39 mm		

Pushbuttons and Emergency Stops

Pushbuttons and Emergency Stops - Dimensions

Type	Function	Actuator head diameter [mm]	Panel wall thickness [mm]	Diameter thru-hole [mm]	Length outside enclosure [mm]	Total length [mm]	Mass [g]
		D2	PT	DT	H	L	
CFP.P*	pushbutton	39	1 ... 6	30.6	15.5	35.4	25
CFP.DM*	double pushbutton	70 x 39	1 ... 6	30.6	15.5	35.4	38
CFP.E4	emergency stop	40	1 ... 6	30.6	41.8	62.1	52
CFP.E5	emergency stop	55	1 ... 6	30.6	41.8	62.1	58
CFP.JR	key release mushroom button	39	1 ... 6	30.6	49.5	70	65
CFP.M*	mushroom button	37	1 ... 6	30.6	41.2	60.7	46

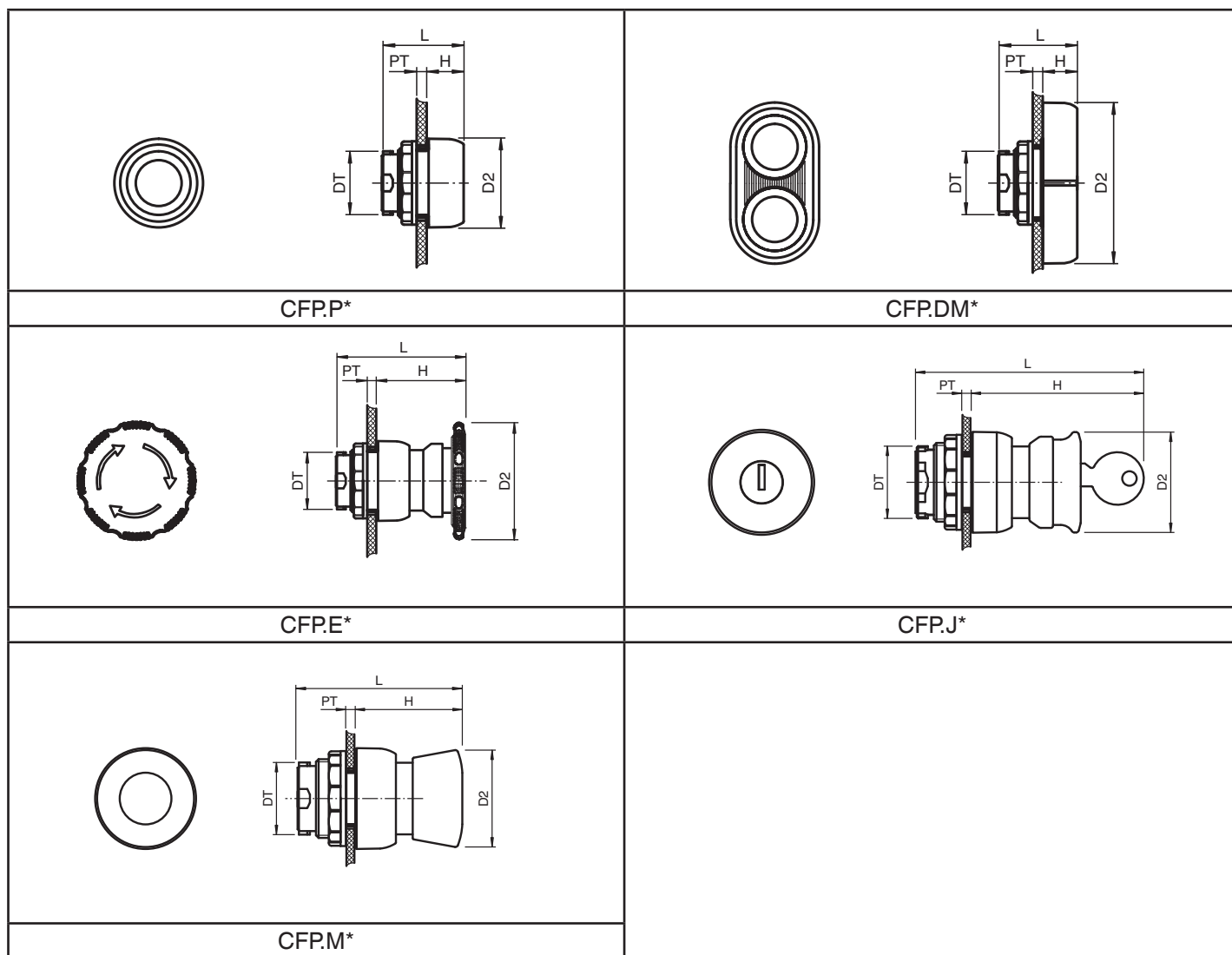

Release date: 2022-12-14 Date of issue: 2022-12-14 Filename: t199946_eng.pdf

Refer to "General Notes Relating to Pepperl+Fuchs Product Information".

Pushbuttons and Emergency Stops

Contact Blocks					
Type	Mounting	Number of poles	Contact configuration	Switching diagram see overview	Image
CFP.A	cover-mounted	2	1x NO / 1x NC		
CFP.B	cover-mounted	2	2x NC		
CFP.D	cover-mounted	2	2x NO		

Contact Blocks - Technical Data

Electrical specifications

Operating voltage	250 V max.
Operating current	16 A max.
Terminal capacity	2.5 mm ²
Terminal torque	0.8 Nm
Usage category	AC12: 12 ... 250 V AC - 16 A AC15: 12 ... 250 V AC - 10 A DC13: 12 ... 110 V DC - 1 A DC13: 12 ... 24 V DC - 1 A

Mechanical specifications

Mechanical life	1000000 switching operations
Degree of protection	IP20

Material

Housing	Polyamide (PA)
---------	----------------

Ambient conditions

Service temperature	-40 ... 90 °C (-40 ... 194 °F)
---------------------	--------------------------------

Data for application in connection with hazardous areas

EU-Type Examination Certificate	CML 16 ATEX 3339U
---------------------------------	-------------------

Marking	II 2 G Ex de IIC Gb
---------	------------------------

Contact Blocks - Technical Data continued

International approvals

IECEx approval	IECEx CML 16.0114U
----------------	--------------------

Conformity

Degree of protection	EN 60529
Usage category	IEC / EN 60947
CE marking	0102

General information

Supplementary information	EC-Type Examination Certificate, Statement of Conformity, Declaration of Conformity, Attestation of Conformity and instructions have to be observed where applicable. For information see www.pepperl-fuchs.com .
---------------------------	--

Pushbuttons and Emergency Stops

Contact Blocks - Dimensions

Mounting	External dimension [mm]			Mounting holes [mm]			Mounting brackets [mm]	DIN mounting rail receptacle [mm]	Mass [g]	Enclosure type
	A	B	C	G	H	Diam. J	N	G3		
cover-mounted	54	37	63	-	-	-	-	-	79	FXL*.CS SR.CS*

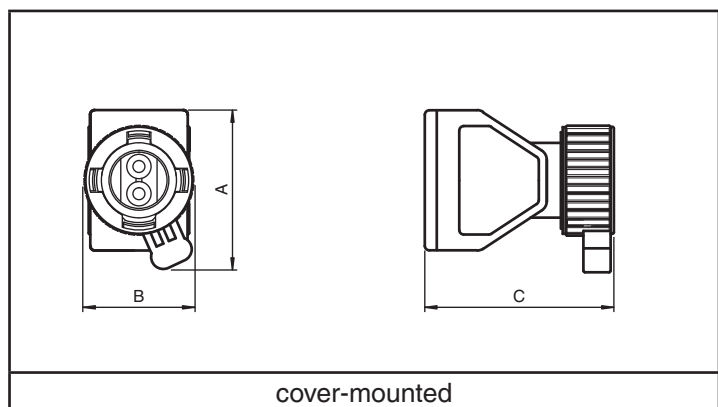

Illuminated Pushbuttons

Illuminated Pushbuttons Actuator Heads				
Type	Lens color	Operator action	Switching diagram	Image
CFP.IR	red	spring return		
CFP.IG	green	spring return		
CFP.IO	amber	spring return		
CFP.IW	white	spring return		
CFP.IB	blue	spring return		

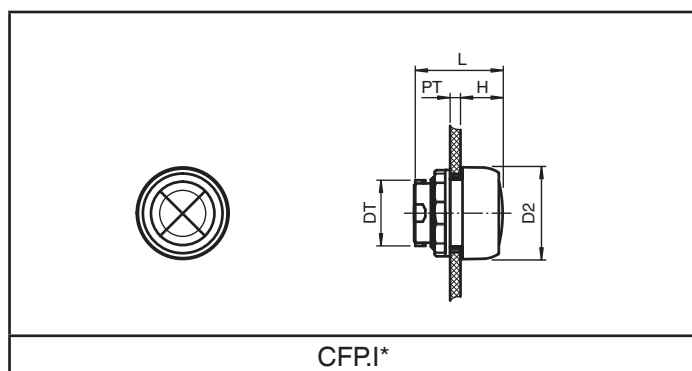

Actuator Heads - Technical Data

Mechanical specifications

Degree of protection IP66

Material

Housing Polyamide (PA)

Finish inherent color black

Washer gasket silicone

Ambient conditions

Ambient temperature -40 ... 55 °C (-40 ... 131 °F)

Service temperature -40 ... 65 °C (-40 ... 149 °F)

Data for application in connection with hazardous areas

EU-Type Examination Certificate CML 16 ATEX 3339U

Marking

II 2 GD
Ex e IIC Gb
Ex tb IIIC Db

International approvals

IECEX approval IECEX CML 16.0114U

Conformity

Degree of protection EN 60529

CE marking 0102

General information

Supplementary information

EC-Type Examination Certificate, Statement of Conformity, Declaration of Conformity, Attestation of Conformity and instructions have to be observed where applicable. For information see www.pepperl-fuchs.com.

Illuminated Pushbuttons Actuator Heads - Dimensions

Actuator head diameter [mm]	Panel wall thickness [mm]	Diameter thru-hole [mm]	Length outside enclosure [mm]	Total length [mm]	Mass [g]	Mounting	Enclosure type
D2	PT	DT	H	L			
39	1 ... 6	30.6	17.5	36.8	21	use with base-mounted and cover-mounted contact modules	LC*, LR* FXL*.CS GR.CS*

Illuminated Pushbuttons

LED Contact Modules

Type	Mounting	Operating voltage [V]	Number of poles	Contact configuration	Switching diagram	Image
CFP.KL	cover-mounted	10 ... 28 V AC/DC	1	1x NO		
CFP.K	cover-mounted	30 ... 250 V AC	1	1x NO		
CFP.KI	cover-mounted	10 ... 28 V AC/DC Ex ia	1	1x NO		
CFP.HL	cover-mounted	10 ... 28 V AC/DC	1	1x NC		
CFP.H	cover-mounted	30 ... 250 V AC	1	1x NC		
CFP.HI	cover-mounted	10 ... 28 V AC/DC Ex ia	1	1x NC		

Illuminated Pushbuttons

LED Contact Modules - Dimensions

Mounting	External dimension [mm]				Mounting holes [mm]			Mounting brackets [mm]	DIN rail receptacle [mm]	Mass [g]	Enclosure type
	A	B	C	L	G	H	Diam. J	N	G3		
cover-mounted	54	37	63	88	-	-	-	-	-	82	FXL*.CS SR.CS*

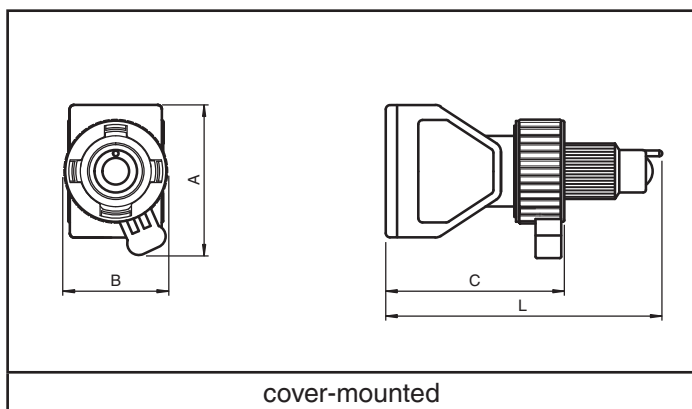

w

LED Modules - Technical Data

Electrical specifications

Operating voltage	250 V max.
Operating current	10 A max.
Power consumption	1 W max.
Terminal capacity	2.5 mm ²
Terminal torque	0.8 Nm
Usage category	AC15: 10 ... 250 V AC - 10 A DC13: 10 ... 24 V DC - 1 A

Mechanical specifications

Mechanical life	1000000 switching operations
Degree of protection	IP20

Material

Housing	Polyamide (PA)
---------	----------------

Ambient conditions

Service temperature	-55 ... 90 °C (-67 ... 194 °F)
---------------------	--------------------------------

Data for application in connection with hazardous areas

EU-Type Examination Certificate	CML 16 ATEX 3339U
Marking	Ex II 2 G Ex de IIC Gb

Intrinsically safe variants

Marking	Ex II 1 G Ex ia IIC Ga
---------	---------------------------

Voltage U _i	28 V
Current I _i	93 mA
Power P _i	0.651 W
Internal capacitance C _i	0 µF
Internal inductance L _i	0 mH

International approvals

IECEX approval	IECEX CML 16.0114U
----------------	--------------------

Conformity

Degree of protection	EN 60529
Usage category	IEC / EN 60947-3
CE marking	0102

LED Modules - Technical Data

General information

Supplementary information

EC-Type Examination Certificate, Statement of Conformity, Declaration of Conformity, Attestation of Conformity and instructions have to be observed where applicable. For information see www.pepperl-fuchs.com.

Control Switches Actuator Heads, for use with SR.CS* and FXLS*.CS

Control Switch Actuator Heads								
Type	Function	Diameter [mm]	Switching configuration	Switching diagram	Operator action	Labeling	Lockable	Image
CFP.N6	rotary actuator	39	2 position changeover with left OFF		L - L	0 - I	-	
CFP.N7	rotary actuator	39	2 position changeover		L - L	I - II	-	
CFP.N8	rotary actuator	39	3 position changeover with center OFF		L - L - L	I - 0 - II	-	
CFP.N8S	rotary actuator	39	3 position changeover with center OFF		S - L - S	I - 0 - II	-	
CFP.N9	rotary actuator	39	3 position changeover with left OFF		L - L - L	0 - I - II	-	
CFP.S6	rotary actuator	60	2 position changeover with left OFF		L - L	0 - I	yes	
CFP.S7	rotary actuator	60	2 position changeover		L - L	I - II	-	
CFP.S8	rotary actuator	60	3 position changeover with center OFF		L - L - L	I - 0 - II	yes	
CFP.S8S	rotary actuator	60	3 position changeover with center OFF		S - L - S	I - 0 - II	yes	
CFP.S9	rotary actuator	60	3 position changeover with left OFF		L - L - L	0 - I - II	yes	
CFP.K6	key switch rotary actuator	39	2 position changeover with left OFF		L - L	0 - I	yes	
CFP.K6S	key switch rotary actuator	39	2 position changeover with left OFF		L - S	0 - I	yes	
CFP.K8	key switch rotary actuator	39	3 position changeover with center OFF		L - L - L	I - 0 - II	yes	
CFP.K8S	key switch rotary actuator	39	3 position changeover with center OFF		S - L - S	I - 0 - II	yes	

Operator action: L = latching, S = spring return

Control Switches Actuator Heads

Actuator Heads - Dimensions

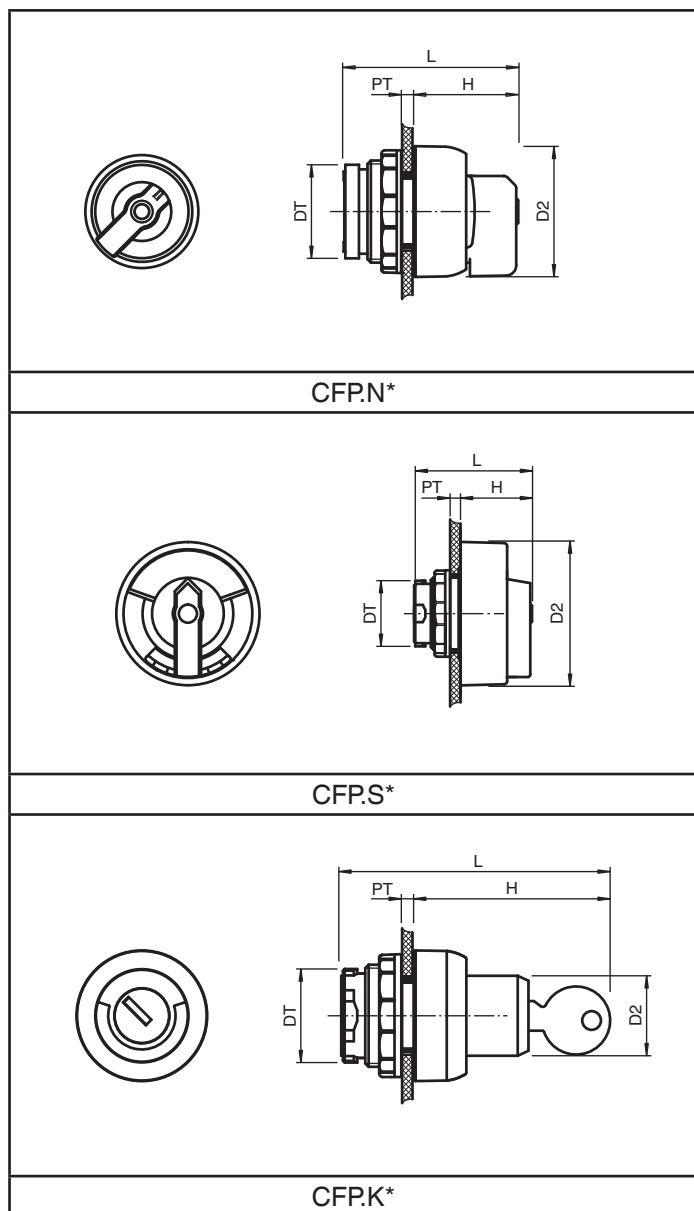

Actuator Heads - Technical Data

Mechanical specifications	
Dimensions	see data table
Mounting	use with base-mounted and lid-mounted contact modules
Degree of protection	IP66
Mass	see data table
Material	
Housing	Polyamide (PA)
Finish	inherent color black
Washer gasket	silicone
Ambient conditions	
Ambient temperature	-40 ... 55 °C (-40 ... 131 °F)
Service temperature	-40 ... 65 °C (-40 ... 149 °F)
Data for application in connection with hazardous areas	
EU-Type Examination Certificate	CML 16 ATEX 3339U
Marking	II 2 GD Ex e IIC Gb Ex tb IIIC Db
International approvals	
IECEX approval	IECEX CML 16.0114U
Conformity	
Degree of protection	EN 60529
CE marking	0102
General information	
Supplementary information	EC-Type Examination Certificate, Statement of Conformity, Declaration of Conformity, Attestation of Conformity and instructions have to be observed where applicable. For information see www.pepperl-fuchs.com .

Type	Actuator head diameter [mm]	Panel wall thickness [mm]	Diameter thru-hole [mm]	Length outside enclosure [mm]	Total length [mm]	Mass [g]	Image example
	D2	PT	DT	H	L		
CFP.N*	39	1 ... 6	30.6	30.5	50.5	30	
CFP.S*	60	1 ... 6	30.6	30.5	50.5	46	
CFP.K*	39	1 ... 6	30.6	49.5	70	46	

Refer to "General Notes Relating to Pepperl+Fuchs Product Information".

Pepperl+Fuchs Group
www.pepperl-fuchs.comUSA: +1 330 486 0002
pa-info@us.pepperl-fuchs.comGermany: +49 621 776 2222
pa-info@de.pepperl-fuchs.comSingapore: +65 6779 9091
pa-info@sg.pepperl-fuchs.com

PEPPERL+FUCHS

Control Switches, 2 Pole Contact Blocks, for use with SR.CS* and FXL*.CS

Combination of 2 Pole Contact Blocks and Actuator Heads									
Actuator head function	Actuator head diameter [mm]	Switching configuration	Contact block	Contacts	Switching diagram see overview	Operator action	Labeling	Lockable	Actuator type
rotary actuator	39	2 position changeover with left OFF	D	2x NO	(1)	L - L	0 - I	-	N6
rotary actuator	39	2 position changeover	A	1x NO / 1x NC	(2)	L - L	I - II	-	N7
rotary actuator	39	3 position changeover with center OFF	D	2x NO	(4)	L - L - L	I - 0 - II	-	N8
rotary actuator	39	3 position changeover with center OFF	D	2x NO	(4)	S - L - S	I - 0 - II	-	N8S
rotary actuator	39	3 position changeover with left OFF	A	1x NO / 1x NC	(3)	L - L - L	0 - I - II	-	N9
rotary actuator	60	2 position changeover with left OFF	D	2x NO	(1)	L - L	0 - I	yes	S6
rotary actuator	60	2 position changeover	A	1x NO / 1x NC	(2)	L - L	I - II	-	S7
rotary actuator	60	3 position changeover with center OFF	D	2x NO	(4)	L - L - L	I - 0 - II	yes	S8
rotary actuator	60	3 position changeover with center OFF	D	2x NO	(4)	S - L - S	I - 0 - II	yes	S8S
rotary actuator	60	3 position changeover with left OFF	A	1x NO / 1x NC	(3)	L - L - L	0 - I - II	yes	S9
key switch rotary actuator	39	2 position changeover with left OFF	D	2x NO	(1)	L - L	0 - I	yes	K6
key switch rotary actuator	39	2 position changeover with left OFF	D	2x NO	(1)	L - S	0 - I	yes	K6S
key switch rotary actuator	39	3 position changeover with center OFF	D	2x NO	(4)	L - L - L	I - 0 - II	yes	K8
key switch rotary actuator	39	3 position changeover with center OFF	D	2x NO	(4)	S - L - S	I - 0 - II	yes	K8S

Operator action: L = latching, S = spring return

Contact Blocks					
Type	Mounting	Number of poles	Contact configuration	Switching diagram	Image
CFP.A	cover-mounted	2	1x NO / 1x NC		
CFP.B	cover-mounted	2	2x NC		
CFP.D	cover-mounted	2	2x NO		

Refer to "General Notes Relating to Pepperl+Fuchs Product Information".

Pepperl+Fuchs Group
www.pepperl-fuchs.comUSA: +1 330 486 0002
pa-info@us.pepperl-fuchs.comGermany: +49 621 776 2222
pa-info@de.pepperl-fuchs.comSingapore: +65 6779 9091
pa-info@sg.pepperl-fuchs.com

PEPPERL+FUCHS

Control Switches, 2 Pole Contact Blocks, for use with SR.CS* and FXL*.CS

Switching Diagrams

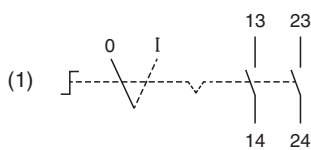

	13	23
0		
I	X	X
	14	24

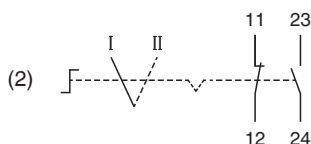

	11	23
I	X	
II		X
	12	24

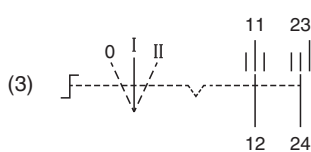

	11	23
0		
I	X	
II		X
	12	24

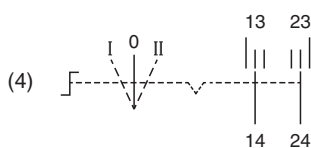

	13	23
I	X	
0		
II		X
	14	24

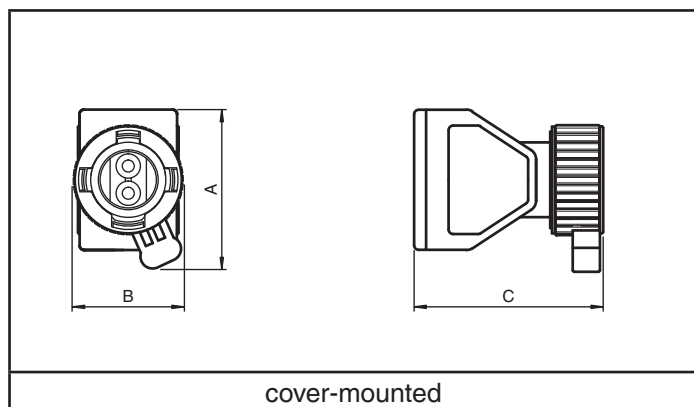

Contact Blocks - Technical Data

Electrical specifications

Operating voltage	250 V max.
Operating current	16 A max.
Terminal capacity	2.5 mm ²
Terminal torque	0.8 Nm

Usage category	AC12: 12 ... 250 V AC - 16 A
	AC15: 12 ... 250 V AC - 10 A
	DC13: 12 ... 110 V DC - 1 A
	DC13: 12 ... 24 V DC - 1 A

Mechanical specifications

Mechanical life	1000000 switching operations
Degree of protection	IP20

Material

Housing	Polyamide (PA)
---------	----------------

Ambient conditions

Service temperature	-40 ... 90 °C (-40 ... 194 °F)
---------------------	--------------------------------

Data for application in connection with hazardous areas

EU-Type Examination Certificate	CML 16 ATEX 3339U
---------------------------------	-------------------

Marking	II 2 G Ex de IIC Gb
---------	------------------------

International approvals

IECEx approval	IECEx CML 16.0114U
----------------	--------------------

Conformity

Degree of protection	EN 60529
Usage category	IEC / EN 6094
CE marking	0102

General information

Supplementary information	EC-Type Examination Certificate, Statement of Conformity, Declaration of Conformity, Attestation of Conformity and instructions have to be observed where applicable. For information see www.pepperl-fuchs.com .
---------------------------	--

Contact Blocks - Dimensions

Mounting	External dimension [mm]			Mounting holes [mm]			Mounting brackets [mm]	DIN mounting rail receptacle [mm]	Mass [g]	Enclosure type
	A	B	C	G	H	Diam. J				
cover-mounted	54	37	63	-	-	-	-	-	79	FXL*.CS SR.CS*

Refer to "General Notes Relating to Pepperl+Fuchs Product Information".

Pepperl+Fuchs Group
www.pepperl-fuchs.comUSA: +1 330 486 0002
pa-info@us.pepperl-fuchs.comGermany: +49 621 776 2222
pa-info@de.pepperl-fuchs.comSingapore: +65 6779 9091
pa-info@sg.pepperl-fuchs.com

PEPPERL+FUCHS





Control Switches, 4 Pole Contact Blocks, for use with SR.CS* and FXL*.CS

Combination of 4 Pole Contact Blocks and Actuator Heads

Actuator head function	Actuator head diameter [mm]	Switching configuration	Contact block	Contacts	Switching diagram see overview	Operator action	Labeling	Lockable	Actuator type
rotary actuator	60	2 position changeover with left OFF	52	4x NO	(5)	L - L	0 - I	yes	S6
rotary actuator	60	2 position changeover	50	2x NO / 2x NC	(6)	L - L	I - II	-	S7
rotary actuator	60	3 position changeover with center OFF	52	4x NO	(7)	L - L - L	I - 0 - II	yes	S8
rotary actuator	60	3 position changeover with center OFF	52	4x NO	(7)	S - L - S	I - 0 - II	yes	S8S

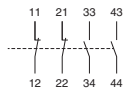
Operator action: L = latching, S = spring return

Contact Blocks

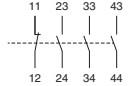
Type	Mounting	Number of poles	Contact configuration	Switching diagram	Image
CFP.50	cover-mounted	4	2x NO / 2x NC		
CFP.51	cover-mounted	4	4x NC		
CFP.52	cover-mounted	4	4x NO		
CFP.53	cover-mounted	4	1x NO / 3x NC		
CFP.54	cover-mounted	4	3x NO / 1x NC		

Control Switches, 4 Pole Contact Blocks, for use with SR.CS* and FXL*.CS

Switching Diagrams

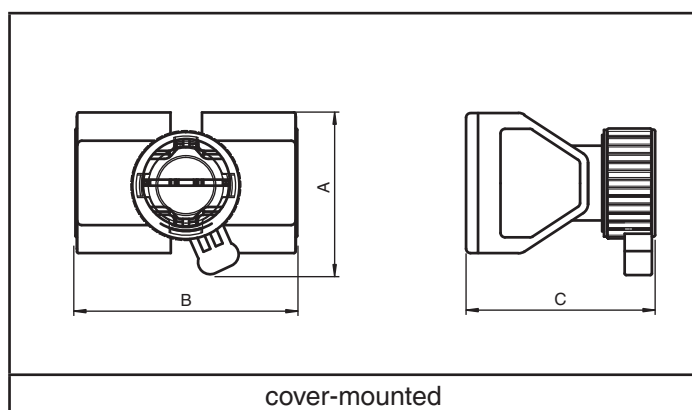
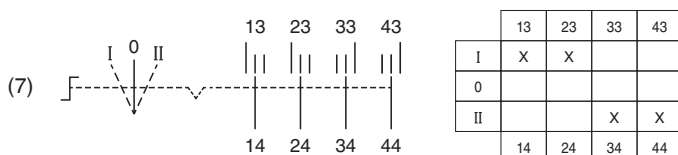
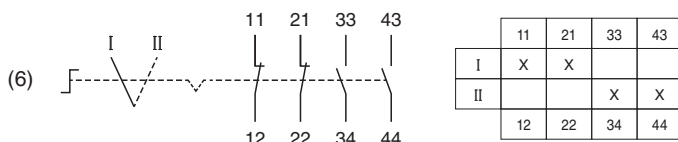
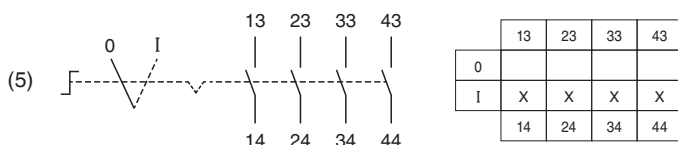

Contact Blocks - Technical Data

Electrical specifications

Operating voltage	250 V max.
Operating current	16 A max.
Terminal capacity	2.5 mm ²
Terminal torque	0.8 Nm
Usage category	AC12: 12 ... 250 V AC - 16 A AC15: 12 ... 250 V AC - 10 A DC13: 12 ... 110 V DC - 1 A DC13: 12 ... 24 V DC - 1 A

Mechanical specifications

Mechanical life	1000000 switching operations
Degree of protection	IP20

Material

Housing	Polyamide (PA)
---------	----------------

Ambient conditions

Service temperature	-40 ... 90 °C (-40 ... 194 °F)
---------------------	--------------------------------

Data for application in connection with hazardous areas

EU-Type Examination Certificate	CML 16 ATEX 3339U
---------------------------------	-------------------

Marking	II 2 G Ex de IIC Gb
---------	------------------------

International approvals

IECEx approval	IECEx CML 16.0114U
----------------	--------------------

Conformity

Degree of protection	EN 60529
Usage category	IEC / EN 60947
CE marking	0102

General information

Supplementary information	EC-Type Examination Certificate, Statement of Conformity, Declaration of Conformity, Attestation of Conformity and instructions have to be observed where applicable. For information see www.pepperl-fuchs.com .
---------------------------	--

Contact Blocks - Dimensions

Mounting	External dimension [mm]			Mounting holes [mm]			Mounting brackets [mm]	DIN mounting rail receptacle [mm]	Mass [g]	Enclosure type
	A	B	C	G	H	Diam. J				
cover-mounted	57	73.4	65.7	-	-	-	-	G3	168	FXL*.CS SR.CS*

Refer to "General Notes Relating to Pepperl+Fuchs Product Information".

Pepperl+Fuchs Group
www.pepperl-fuchs.comUSA: +1 330 486 0002
pa-info@us.pepperl-fuchs.comGermany: +49 621 776 2222
pa-info@de.pepperl-fuchs.comSingapore: +65 6779 9091
pa-info@sg.pepperl-fuchs.com

PEPPERL+FUCHS

Control Switches, 4 Pole Rotary Switching Blocks, for use with SR.CS* and FXL*.CS

Combination of 4 Pole Rotary Switching Blocks and Actuator Heads							
Switching configuration	Switching block	Contacts	Switching diagram see overview	Operator action	Labeling	Lockable	Actuator type
2 position changeover, left OFF	60	4x NO	(10)	L - L	0 - I	yes	T6
2 position changeover	61	2x NO / 2x NC	(11)	L - L	I - II	-	T7
2 position changeover	67	3x NO / 1x NC	(17)	L - L	I - II	-	T7
2 position changeover	68	1x NO / 3x NC	(18)	L - L	I - II	-	T7
3 position changeover, center OFF	62	4x NO	(12)	L - L - L	I - 0 - II	yes	T8
3 position changeover, center OFF	64	4x NO	(14)	L - L - L	I - 0 - II	yes	T8
3 position changeover, center OFF, both sides spring return	63	4x NO	(13)	S - L - S	I - 0 - II	yes	T8
3 position changeover	72	4x NO	(22)	L - L - L	I - 0 - II	-	T8
3 position changeover	73	4x NO	(23)	L - L - L	0 - I - II	-	T0
3 position changeover, right spring return	69	2x NO / 2x NC	(19)	L - L - S	0 - I - II	-	T0
3 position changeover, right spring return	66	3x NO / 1x NC	(16)	L - L - S	0 - I - II	-	T0
4 position changeover	65	3x NO / 1x NC	(15)	L - L - L - L	I - II - III - IV	-	T9
4 position changeover, right spring return	70	4x NO	(20)	L - L - L - S	I - II - III - IV	-	T9
4 position changeover	71	4x NO	(21)	L - L - L - L	I - II - III - IV	-	T9

Operator action: L = latching, S = spring return

Control Switches, 4 Pole Rotary Switching Blocks, for use with SR.CS* and FXL*.CS

Dimensions

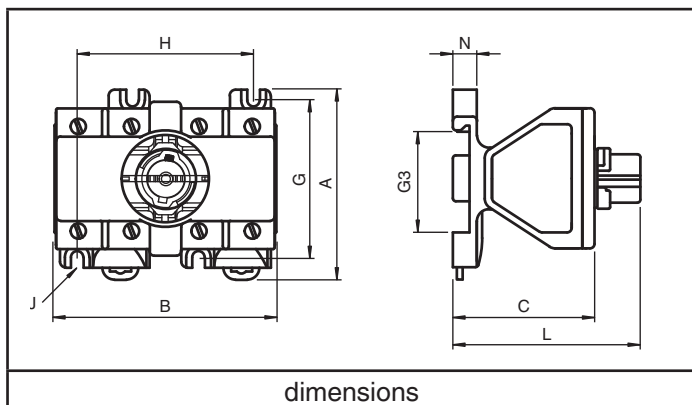
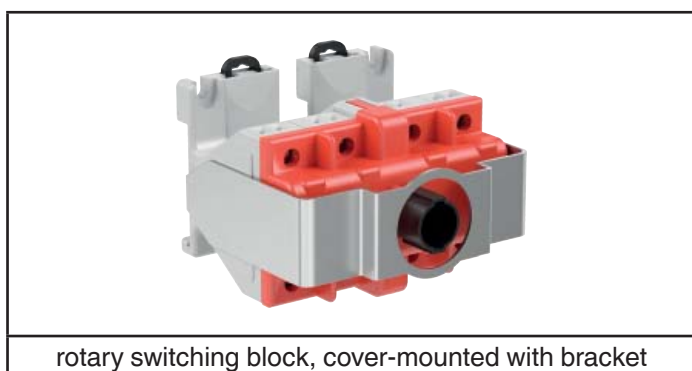

Switching Blocks - Technical Data

Electrical specifications

Operating voltage	250 V max.
Operating current	16 A max.
Terminal capacity	2.5 mm ²
Terminal torque	0.8 Nm
Usage category	AC12: 12 ... 250 V AC - 16 A AC15: 12 ... 250 V AC - 10 A DC13: 12 ... 110 V DC - 1 A DC13: 12 ... 24 V DC - 1 A

Mechanical specifications

Mechanical life	1000000 switching operations
Degree of protection	IP20

Material

Housing	Polyamide (PA)
---------	----------------

Ambient conditions

Service temperature	-40 ... 90 °C (-40 ... 194 °F)
---------------------	--------------------------------

Data for application in connection with hazardous areas

EU-Type Examination Certificate	CML 16 ATEX 3339U
Marking	II 2 G Ex de IIC Gb

International approvals

IECEx approval	IECEx CML 16.0114U
----------------	--------------------

Conformity

Degree of protection	EN 60529
Usage category	IEC / EN 60947
CE marking	0102

General information

Supplementary information	EC-Type Examination Certificate, Statement of Conformity, Declaration of Conformity, Attestation of Conformity and instructions have to be observed where applicable. For information see www.pepperl-fuchs.com .
---------------------------	--

Switching Blocks - Dimensions

Mounting	External dimension [mm]			Mounting holes [mm]			Mounting brackets [mm]	DIN mounting rail receptacle [mm]	Mass [g]	Enclosure type
	A	B	C	G	H	Diam. J				
cover-mounted	63	74	72	-	-	-	-	-	235	FXL*.CS SR.CS*

Refer to "General Notes Relating to Pepperl+Fuchs Product Information".

Pepperl+Fuchs Group
www.pepperl-fuchs.comUSA: +1 330 486 0002
pa-info@us.pepperl-fuchs.comGermany: +49 621 776 2222
pa-info@de.pepperl-fuchs.comSingapore: +65 6779 9091
pa-info@sg.pepperl-fuchs.com



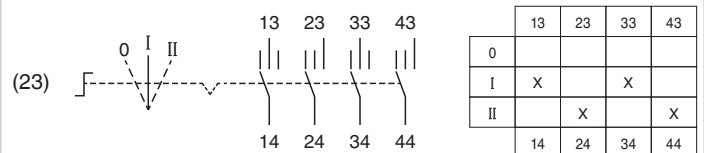
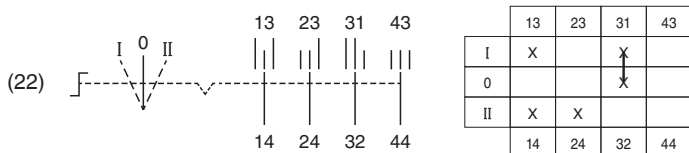
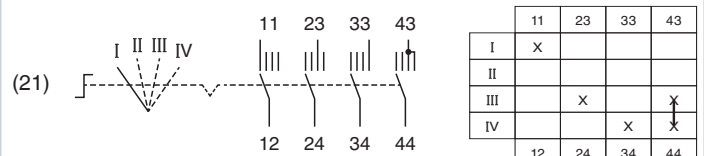
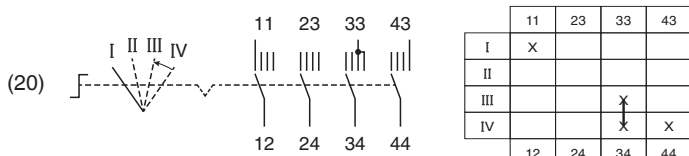
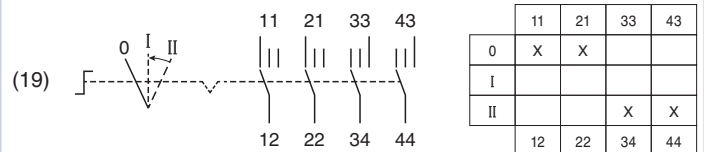
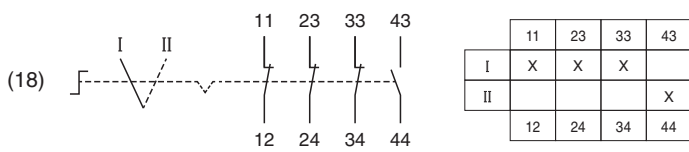
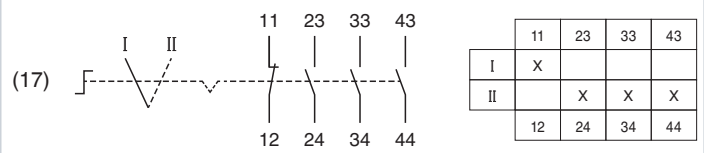
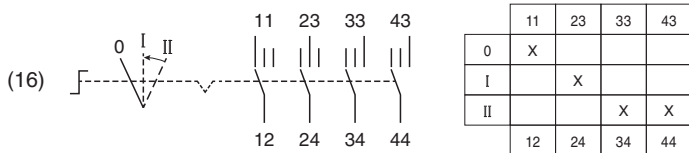
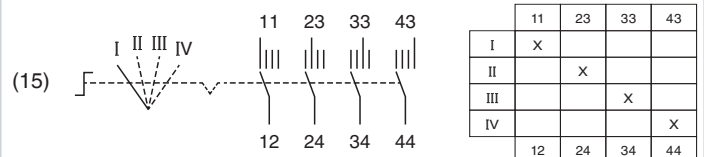
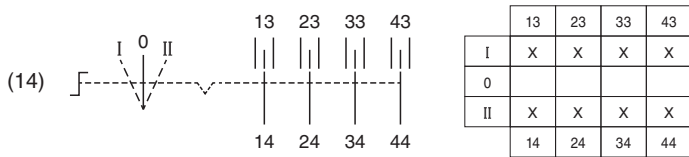
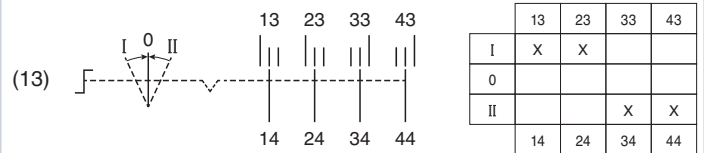
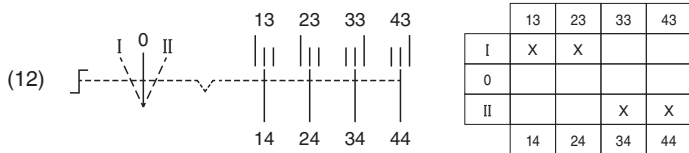
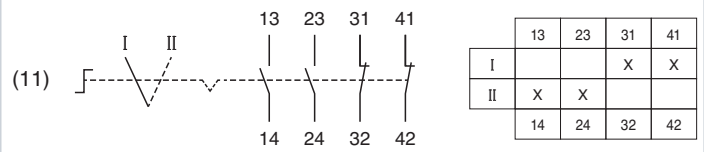
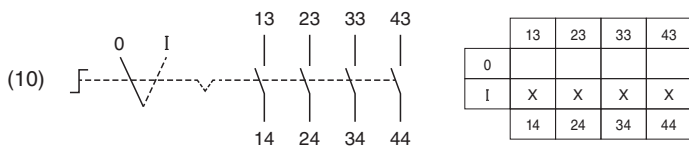

PEPPERL+FUCHS

Control Switches, 4 Pole Rotary Switching Blocks, Switching diagrams



Release date: 2022-12-14 Date of issue: 2022-12-14 Filename: t199946_eng.pdf

LED Indicators

LED Indicators Lenses		
Type	Lens color	Image
CFPLR	red	
CFPLG	green	
CFPLO	amber	
CFPLW	white	
CFPLB	blue	

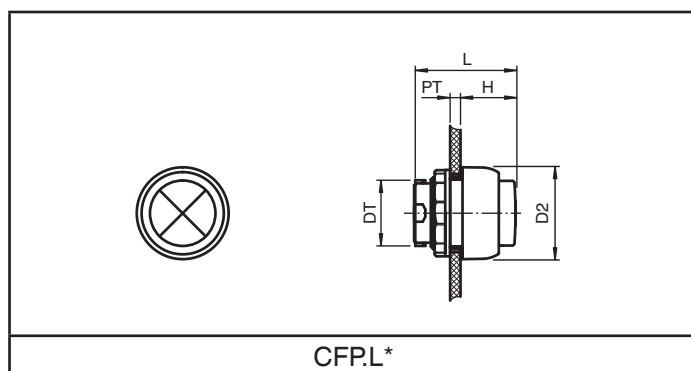

LED Heads - Technical Data

Mechanical specifications

Degree of protection IP66

Material

Housing Polyamide (PA)

Finish inherent color black

Washer gasket silicone

Ambient conditions

Ambient temperature -40 ... 55 °C (-40 ... 131 °F)

Service temperature -40 ... 65 °C (-40 ... 149 °F)

Data for application in connection with hazardous areas

EU-Type Examination Certificate CML 16 ATEX 3339U

Marking

 II 2 GD
Ex e IIC Gb
Ex tb IIIC Db

International approvals

IECEX approval IECEX CML 16.0114U

Conformity

Degree of protection EN 60529

CE marking 0102

General information

Supplementary information

EC-Type Examination Certificate, Statement of Conformity, Declaration of Conformity, Attestation of Conformity and instructions have to be observed where applicable. For information see www.pepperl-fuchs.com.

LED Heads - Dimensions

Diameter [mm]	Panel wall thickness [mm]	Diameter thru-hole [mm]	Length outside enclosure [mm]	Total length [mm]	Mass [g]	Mounting	Enclosure type
D2	PT	DT	H	L			
39	1 ... 6	30.6	23.6	43	20	use with base-mounted and cover-mounted LED modules	LC* FXL* CS GR.CS*

LED Indicators

LED Modules

Type	Mounting	Rated operating voltage [V AC/DC]	Image
CFP.GI	cover-mounted	10 ... 28, Ex ia	
CFP.GE	cover-mounted	10 ... 28	
CFP.R	cover-mounted	30 ... 250	

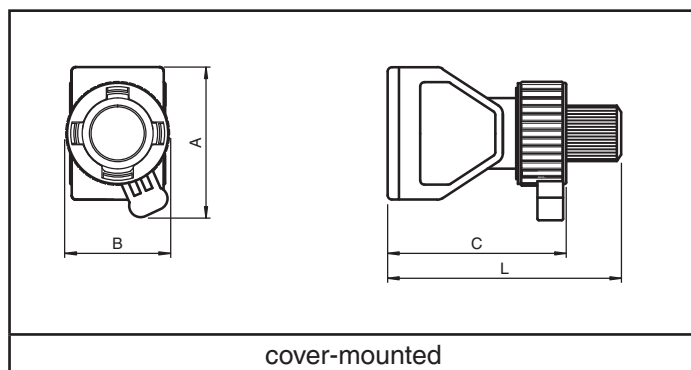

LED Modules - Technical Data

Electrical specifications

Operating voltage	250 V max.
Power consumption	2 W max.
Terminal capacity	2.5 mm ²
Terminal torque	0.8 Nm

Mechanical specifications

Degree of protection	IP20
----------------------	------

Material

Housing	Polyamide (PA)
---------	----------------

Ambient conditions

Service temperature	-40 ... 90 °C (-40 ... 194 °F)
---------------------	--------------------------------

Data for application in connection with hazardous areas

EU-Type Examination Certificate	CML 16 ATEX 3339U
---------------------------------	-------------------

Marking	 II 2 G Ex de IIC Gb
---------	--

Intrinsically safe variants *.NI, *.GI

Marking	 II 1 G Ex ia IIC Ga
---------	--

Voltage U _i	28 V
Current I _i	93 mA
Power P _i	0.651 W
Internal capacitance C _i	0 µF
Internal inductance L _i	0 mH

International approvals

IECEX approval	IECEX CML 16.0114U
----------------	--------------------

Conformity

Degree of protection	EN 60529
CE marking	0102

General information

Supplementary information	EC-Type Examination Certificate, Statement of Conformity, Declaration of Conformity, Attestation of Conformity and instructions have to be observed where applicable. For information see www.pepperl-fuchs.com .
---------------------------	--



LED Modules - Dimensions

Mounting	External dimension [mm]				Mounting holes [mm]			Mounting brackets [mm]	DIN rail receptacle [mm]	Mass [g]	Enclosure type
	A	B	C	L	G	H	Diam. J	N	G3		
cover-mounted	54	37	63	88	-	-	-	-	-	71	FXL*.CS SR.CS*

Refer to "General Notes Relating to Pepperl+Fuchs Product Information".

Pepperl+Fuchs Group
www.pepperl-fuchs.comUSA: +1 330 486 0002
pa-info@us.pepperl-fuchs.comGermany: +49 621 776 2222
pa-info@de.pepperl-fuchs.comSingapore: +65 6779 9091
pa-info@sg.pepperl-fuchs.com PEPPERL+FUCHS

Buzzer

Buzzer Modules				
Type	Function	Color	Rated operating voltage [V AC/DC]	Image
CFP. BUZRF1	flashing buzzer	red	10 ... 28	
CFP. BUZRF2	flashing buzzer	red	30 ... 250	
CFP. BUZKS1	buzzer	black	10 ... 28	
CFP. BUZKS2	buzzer	black	30 ... 250	

Buzzer - Technical Data

Electrical specifications

Operating voltage	250 V max.
Power consumption	1 W max.
Terminal capacity	2.5 mm ²
Terminal torque	0.8 Nm
Sound level	60 dB at 30 cm

Mechanical specifications

Degree of protection	IP66
----------------------	------

Material

Housing	Polyamide (PA)
---------	----------------

Ambient conditions

Ambient temperature	-40 ... 55 °C (-40 ... 131 °F)
Service temperature	-40 ... 90 °C (-40 ... 194 °F)

Data for application in connection with hazardous areas

EU-Type Examination Certificate	CML 16 ATEX 3339U
---------------------------------	-------------------

Marking	 II 2 GD Ex e ib mb IIC Gb Ex ib tb IIIC Db
---------	--

International approvals

IECEx approval	IECEx CML 16.0114U
----------------	--------------------

Conformity

Degree of protection	EN 60529
CE marking	0102

General information

Supplementary information	EC-Type Examination Certificate, Statement of Conformity, Declaration of Conformity, Attestation of Conformity and instructions have to be observed where applicable. For information see www.pepperl-fuchs.com .
---------------------------	--

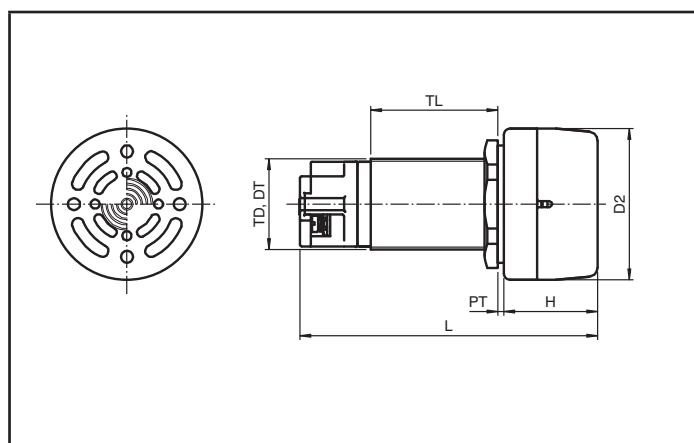

Buzzer - Dimensions

Actuator head diameter [mm]	Panel wall thickness [mm]	Diameter thru-hole [mm]	Length outside enclosure [mm]	Total length [mm]	Thread size	Thread length [mm]	Mass [g]	Mounting	Enclosure type
D2	PT	DT	H	L	TD	TL			
50	1 ... 35	30.6	31	98.5	M30 x 1.5	42	125	cover-mounted	LC*, LR* GR.CS* SR.CS* FXL*.CS

Ammeters

Ammeter Modules

Type	Rated operating current	Scales see table	Image
CFP.AA	0 ... 1 A	scale per specification	
CFP.AB	0 ... 5 A	scale per specification	
CFP.AC	4 ... 20 mA	scale 4 ... 20 / 40 mA	
CFP.AD	0 ... 20 mA	scale 0 ... 20 / 40 mA	

Ammeter Scales

Scales	Type Code	Scales	Type Code
0 ... 1 / 5 A	SA	0 ... 150 / 750 A	SM
0 ... 2.5 / 12.5 A	SB	0 ... 200 / 1000 A	SN
0 ... 5 / 25 A	SC	0 ... 250 / 1250 A	SO
0 ... 10 / 50 A	SD	0 ... 300 / 1500 A	SP
0 ... 15 / 75 A	SE	0 ... 400 / 2000 A	SQ
0 ... 20 / 100 A	SU	0 ... 500 / 2500 A	SR
0 ... 25 / 125 A	SF	0 ... 600 / 3000 A	SS
0 ... 30 / 150 A	SG	0 ... 1000 / 5000 A	ST
0 ... 40 / 200 A	SH	Scale as per specification	SZ
0 ... 50 / 250 A	SI		
0 ... 60 / 300 A	SJ		
0 ... 75 / 375 A	SK		
0 ... 100 / 500 A	SL		

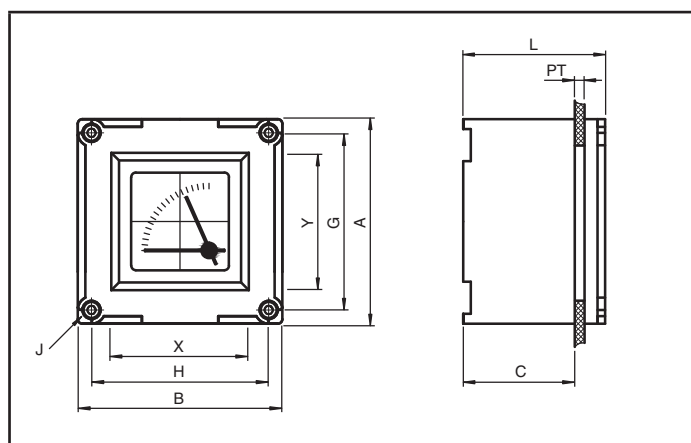

Ammeter Modules - Dimensions

External dimension [mm]				Viewing window [mm]		Panel wall thickness [mm]	Mounting holes [mm]			Mass [g]	Enclosure type
A	B	C	L	X	Y	PT	G	H	Diam. J		
70	70	59	75	54	50	1 ... 6	63	63	3.5	186	LC*, LR* FXL*.CS, SR.CS* GR.CS

Ammeter Modules - Technical Data

Electrical specifications

Operating voltage	500 V AC
Operating current	5 A max.
Accuracy class	1.5
Terminal capacity	2.5 mm ²
Terminal torque	0.8 Nm

Mechanical specifications

Degree of protection	IP66
Mounting	Meter window mounting kit

Material

Housing	Polyamide (PA)
---------	----------------

Ambient conditions

Service temperature	-40 ... 95 °C (-40 ... 203 °F)
---------------------	--------------------------------

Data for application in connection with hazardous areas

EU-Type Examination Certificate	CML 16 ATEX 3339U
Marking	 II 2 G Ex e IIC Gb

International approvals

IECEx approval	IECEx CML 16.0114U
----------------	--------------------

Conformity

Degree of protection	EN 60529
CE marking	0102

General information

Supplementary information	EC-Type Examination Certificate, Statement of Conformity, Declaration of Conformity, Attestation of Conformity and instructions have to be observed where applicable. For information see www.pepperl-fuchs.com .
---------------------------	--

Meter Window Mounting Kits

Type	Window including	Enclosure type
CFP.WB	base mounting kit	L*, GR.CS*
CFP.WL	cover mounting kit	FXL*.CS, SR.CS*

Voltmeters

Voltmeter Modules		
Type	Rated operating voltage	Image
CFP.V6	0 ... 10 V	
CFP.V1	0 ... 25 V	
CFP.V2	0 ... 40 V	
CFP.V7	0 ... 50 V	
CFP.V8	0 ... 100 V	
CFP.V9	0 ... 120 V	
CFP.V3	0 ... 150 V	
CFP.V4	0 ... 250 V	
CFP.V5	0 ... 500 V	

Voltmeter Scales

included in module

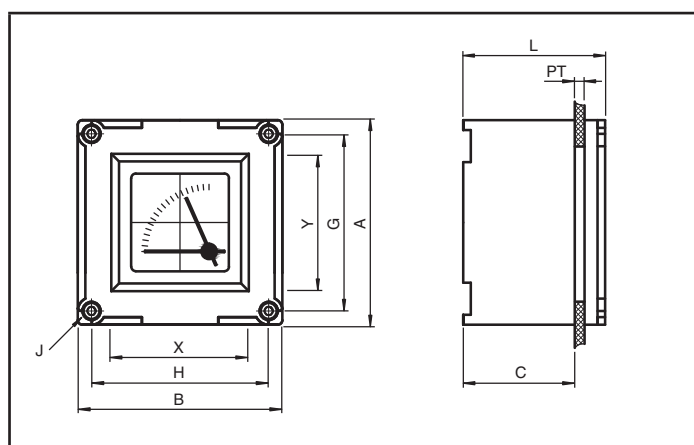

Voltmeter Modules - Technical Data

Electrical specifications

Operating voltage	500 V AC
Accuracy class	1.5
Terminal capacity	2.5 mm ²
Terminal torque	0.8 Nm

Mechanical specifications

Degree of protection	IP66
Mounting	Meter window mounting kit

Material

Housing	Polyamide (PA)
---------	----------------

Ambient conditions

Service temperature	-40 ... 95 °C (-40 ... 203 °F)
---------------------	--------------------------------

Data for application in connection with hazardous areas

EU-Type Examination Certificate	CML 16 ATEX 3339U
Marking	 II 2 G Ex e IIC Gb

International approvals

IECEX approval	IECEX CML 16.0114U
----------------	--------------------

Conformity

Degree of protection	EN 60529
CE marking	0102

General information

Supplementary information	EC-Type Examination Certificate, Statement of Conformity, Declaration of Conformity, Attestation of Conformity and instructions have to be observed where applicable. For information see www.pepperl-fuchs.com .
---------------------------	--

Meter Window Mounting Kits

Type	Window including	Enclosure type
CFP.WB	base mounting kit	L*, GR.CS*
CFP.WL	cover mounting kit	FXL*.CS, SR.CS*

Voltmeter Modules - Dimensions

External dimension [mm]				Viewing window [mm]		Panel wall thickness [mm]	Mounting holes [mm]			Mass [g]	Enclosure type
A	B	C	L	X	Y	PT	G	H	Diam. J		
70	70	59	75	54	50	1 ... 6	63	63	3.5	186	LC*, LR* FXL*.CS, SR.CS* GR.CS*

Refer to "General Notes Relating to Pepperl+Fuchs Product Information".

Pepperl+Fuchs Group
www.pepperl-fuchs.com

USA: +1 330 486 0002
pa-info@us.pepperl-fuchs.com

Germany: +49 621 776 2222
pa-info@de.pepperl-fuchs.com

Singapore: +65 6779 9091
pa-info@sg.pepperl-fuchs.com

 **PEPPERL+FUCHS**

Potentiometers

Potentiometer Actuator Heads

Type	Enclosure type	Labeling	Image
CFP.R2	FXL*.CS SR.CS*	0 ... 10	

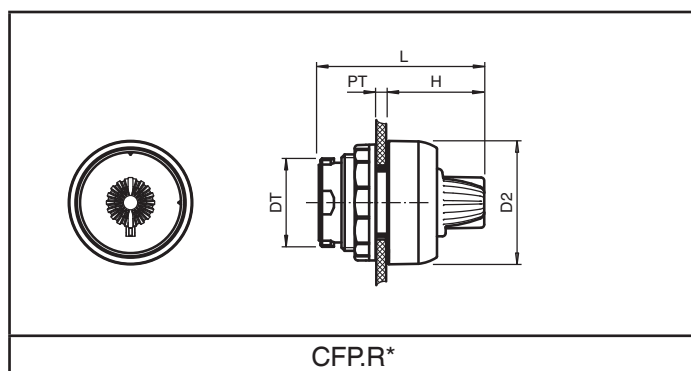

Actuator Heads - Technical Data

Mechanical specifications

Degree of protection IP66

Material

Housing Polyamide (PA)

Finish inherent color black

Washer gasket silicone

Ambient conditions

Ambient temperature -40 ... 55 °C (-40 ... 131 °F)

Service temperature -40 ... 65 °C (-40 ... 149 °F)

Data for application in connection with hazardous areas

EU-Type Examination Certificate CML 16 ATEX 3339U

Marking  II 2 GD
Ex e IIC Gb
Ex tb IIIC Db

International approvals

IECEX approval IECEX CML 16.0114U

Conformity

Degree of protection EN 60529

CE marking 0102

General information

Supplementary information EC-Type Examination Certificate, Statement of Conformity, Declaration of Conformity, Attestation of Conformity and instructions have to be observed where applicable. For information see www.pepperl-fuchs.com.

Potentiometer Actuator Heads - Dimensions

Actuator head diameter [mm]	Panel wall thickness [mm]	Diameter thru-hole [mm]	Length outside enclosure [mm]	Total length [mm]	Mass [g]	Mounting
D2	PT	DT	H	L		
39	1 ... 6	30.6	30.5	50.5	27	use with base-mounted and cover-mounted potentiometer modules

Potentiometers

Potentiometer Modules

Type	Mounting	Range [kΩ]	Image
CFP.4	cover-mounted	0 ... 0.5	
CFP.6	cover-mounted	0 ... 1	
CFP.7	cover-mounted	0 ... 2	
CFP.8	cover-mounted	0 ... 5	
CFP.9	cover-mounted	0 ... 10	

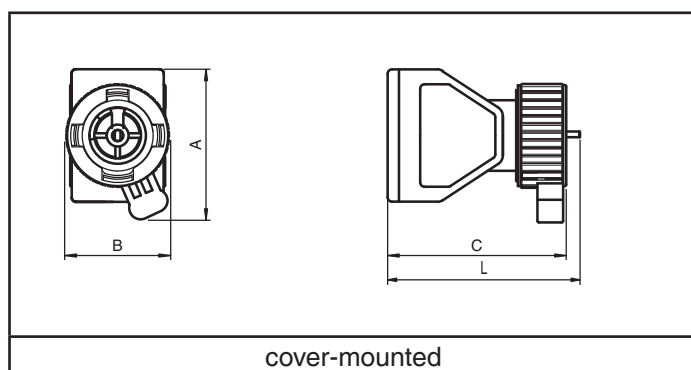

Potentiometer Modules - Technical Data

Electrical specifications

Operating voltage	200 V max.
Power consumption	0.1 W max.
Terminal capacity	2.5 mm ²
Terminal torque	0.8 Nm

Mechanical specifications

Degree of protection	IP20
----------------------	------

Material

Housing	Polyamide (PA)
---------	----------------

Ambient conditions

Service temperature	-55 ... 90 °C (-67 ... 194 °F)
---------------------	--------------------------------

Data for application in connection with hazardous areas

EU-Type Examination Certificate	CML 16 ATEX 3339U
---------------------------------	-------------------

Marking	 II 2 G Ex de IIC Gb
---------	--

International approvals

IECEX approval	IECEX CML 16.0114U
----------------	--------------------

Conformity

Degree of protection	EN 60529
CE marking	0575







General information







Supplementary information	EC-Type Examination Certificate, Statement of Conformity, Declaration of Conformity, Attestation of Conformity and instructions have to be observed where applicable. For information see www.pepperl-fuchs.com .
---------------------------	--

Potentiometer Modules - Dimensions

Mounting	External dimension [mm]				Mounting holes [mm]			Mounting brackets [mm]	DIN rail receptacle [mm]	Mass [g]	Enclosure type
	A	B	C	L	G	H	Diam. J	N	G3		
cover-mounted	54	37	63	65	-	-	-	-	-	78	FXL*.CS SR.CS*

Operating Elements Accessories

Accessory		
Type	Description	Image
CFP.BK	Blanking plug	
CFP.ZT	Extra small label holder with printed label as per specification	
CFP.ZS	Small label holder with printed label as per specification	
CFP.ZL	Large label holder with printed label as per specification	
CFP.ZEB	Emergency stop label, yellow, round	
CFP.ZEB.V2	Emergency stop label, yellow, round, engraved NOT HALT EMERGENCY STOP	
CFP.TP	Locknut spanner, plastic	

Accessory		
Type	Description	Image
CFP.ZB CFP.ZBR (1) (8)	Protective flap for small actuators, plastic, padlockable	
CFP.ZJ CFP.ZJR (1) (8)	Protective pushbutton flap with continuous operation, plastic, padlockable	
CFP.ZH (3)	Protective flap for double pushbutton, stainless steel, padlockable	
CFP.ZA CFP.ZAR (4) (8) (9)	Protective flap, plastic	
CFP.ZP CFP.ZPR (5) (8)	Emergency stop shroud, plastic, padlockable, supplied with padlock and 2 keys	
CFP.ZDT (6) (9)	Protective flap, stainless steel	
CFP.ZCT (7)	Protective flap, stainless steel, padlockable	

- (1) CFP.ZB* are designed for use with CFP.P* pushbuttons, CFP.I* illuminated pushbuttons, CFP.N* small switches, CFP.R* potentiometer actuators
- (2) CFP.ZJ* are designed for use with CFP.P* pushbuttons
- (3) CFP.ZH is designed for use with CFP.D* double pushbuttons
- (4) CFP.ZA* are designed for use with CFP.S* large switches, CFP.E* emergency stops
- (5) CFP.ZP* are designed for use with CFP.E4 emergency stop buttons, the shroud can either be used without the bar to avoid accidental operation or with the bar to padlock in the operated position
- (6) CFP.ZDT is designed for use with both CFP.E4 and CFP.E5 emergency stop buttons
- (7) CFP.ZCT is designed for use with both CFP.E4 and CFP.E5 emergency stop buttons. The shroud is used to padlock the emergency stop in the operated position and when not in use, the flap should be left open
- (8) Accessories that have two options, use a R at the end of the typecode for use with rail mounted contact blocks and those without R are used for cover mounted contact blocks only
- (9) Shrouds and flaps potentially prevent free and unimpaired access to an emergency stop button. These products may therefore only be used in applications where their use has been assessed and not found to cause unacceptable risk to health and safety of persons or damage to the protected machinery.