

Synchro clamping element

9312-3



Synchro clamping element

Dimensions

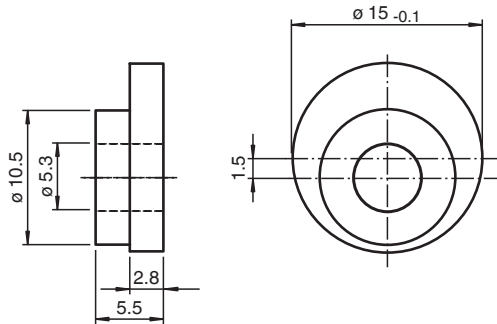

Technical Data

General information

Scope of delivery	3 item(s)
-------------------	-----------

Release date: 2022-04-21 Date of issue: 2022-12-12 Filename: 045042_eng.pdf

Refer to "General Notes Relating to Pepperl+Fuchs Product Information".

Pepperl+Fuchs Group
www.pepperl-fuchs.com

USA: +1 330 486 0001
fa-info@us.pepperl-fuchs.com

Germany: +49 621 776 1111
fa-info@de.pepperl-fuchs.com

Singapore: +65 6779 9091
fa-info@sg.pepperl-fuchs.com

 **PEPPERL+FUCHS**