

Coupling

9401 10*12



- Universally suitable for backlash-free rotation transmission
- Highly vibration-isolating
- Well misalignment compensation
- Low torsion spring stiffness
- Small reset forces
- No movable parts
- Very rugged construction

Spring steel coupling

Dimensions

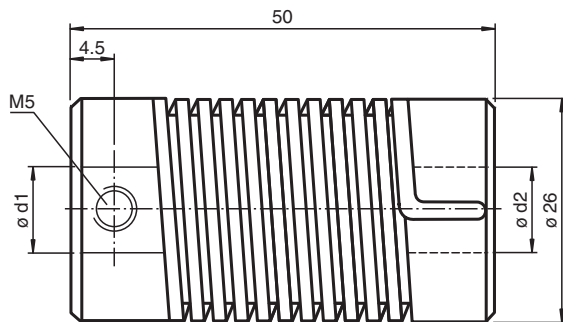

Technical Data

Ambient conditions	
Operating temperature	-30 ... 120 °C (-22 ... 248 °F)
Mechanical specifications	
Shaft diameter	d1 = 10 mm , d2 = 12 mm
Material	
Spring	spring steel, nickel plated
End piece	Diecast zinc
Mass	100 g
Rotational speed	max. 3000 min
Max. torque	1.5 Nm
Tightening torque, fastening screws	1.2 Nm
Radial offset	max. ± 1.5 mm
Axial offset	max. ± 1 mm
Angle error	max. ± 5 °
Torsion angle	at torque 0.75 Nm drive shaft view
CW rotation direction	40 °
CCW rotation direction	60 °

Release date: 2022-12-07 Date of issue: 2022-12-12 Filename: 046917_eng.pdf

Refer to "General Notes Relating to Pepperl+Fuchs Product Information".

Pepperl+Fuchs Group
www.pepperl-fuchs.com

USA: +1 330 486 0001
fa-info@us.pepperl-fuchs.com

Germany: +49 621 776 1111
fa-info@de.pepperl-fuchs.com

Singapore: +65 6779 9091
fa-info@sg.pepperl-fuchs.com

PF PEPPERL+FUCHS

Technical Data

Moment of inertia	95 kg m ² x 10 ⁻⁷
Mounting	clamp screws M5 x 6, DIN 916
Tightening torque of clamping screws	max. 3 Nm

Release date: 2022-12-07 Date of issue: 2022-12-12 Filename: 046917_eng.pdf

Refer to "General Notes Relating to Pepperl+Fuchs Product Information".

Pepperl+Fuchs Group
www.pepperl-fuchs.comUSA: +1 330 486 0001
fa-info@us.pepperl-fuchs.comGermany: +49 621 776 1111
fa-info@de.pepperl-fuchs.comSingapore: +65 6779 9091
fa-info@sg.pepperl-fuchs.com **PEPPERL+FUCHS**