



Model Number

UB500-18GM75-F-V15

Single head system

Features

- Frequency output
- 3 different output options can be programmed
- Parameterization input
- Synchronization options
- Deactivation option
- Temperature compensation
- Very small unusable area

Diagrams

Characteristic response curve

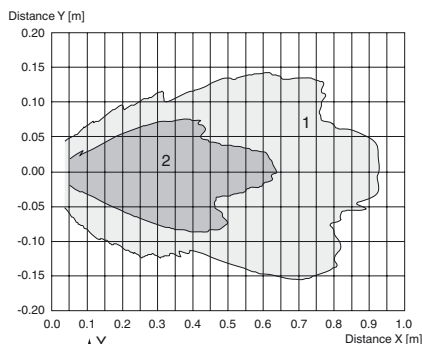

Curve 1: flat surface 100 mm x 100 mm
Curve 2: round bar, Ø 25 mm

Technical data

General specifications

Sensing range	30 ... 500 mm
Unusable area	0 ... 30 mm
Standard target plate	100 mm x 100 mm
Transducer frequency	approx. 380 kHz
Response delay	approx. 50 ms

Indicators/operating means

LED green	Power on
LED red	flashing: error (br>permanent: no object detected)

Electrical specifications

Operating voltage U_B	10 ... 30 V DC , ripple 10 % _{SS}
No-load supply current I_0	≤ 50 mA

Input/Output

Synchronization	1 synchronous connection, bi-directional 0-level: $-U_B \dots +1$ V 1-level: $+4$ V $\dots +U_B$ input impedance: > 12 kΩ synchronization pulse: ≥ 100 μs, synchronization interpulse period: ≥ 2 ms
Synchronization frequency	
Common mode operation	≤ 95 Hz
Multiplex operation	≤ 95/n Hz, n = number of sensors

Input

Input type	1 Parameterization input Input impedance: > 4.7 kΩ
------------	---

Output

Output type	1 frequency output, push/pull, programmable
Resolution	1 mm
Deviation of the characteristic curve	± 1 % of full-scale value
Repeat accuracy	± 0.5 % of full-scale value
Load impedance	> 1000 Ohm < 100 nF
Temperature influence	± 1.5 % of full-scale value

Ambient conditions

Ambient temperature	-25 ... 70 °C (-13 ... 158 °F)
Storage temperature	-40 ... 85 °C (-40 ... 185 °F)

Mechanical specifications

Connection type	Connector M12 x 1 , 5-pin
Degree of protection	IP67
Material	
Housing	brass, nickel-plated
Transducer	epoxy resin/hollow glass sphere mixture; foam polyurethane, cover PBT
Mass	60 g

Compliance with standards and directives

Standard conformity	
Standards	EN 60947-5-2:2007 IEC 60947-5-2:2007 EN 60947-5-7:2003 IEC 60947-5-7:2003

Approvals and certificates

UL approval	cULus Listed, General Purpose
CSA approval	cCSAus Listed, General Purpose
CCC approval	CCC approval / marking not required for products rated ≤36 V

Release date: 2015-03-31 16:09 Date of issue: 2015-03-31 120318_eng.xml

Dimensions

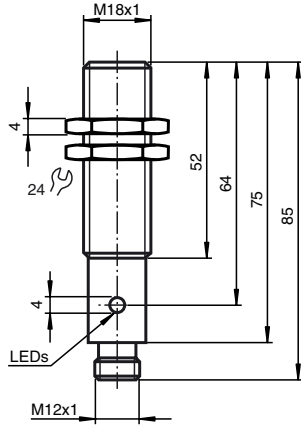

Electrical Connection

Standard symbol/Connections:

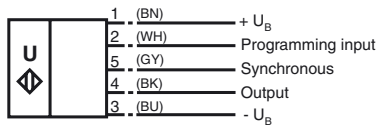

Core colours in accordance with EN 60947-5-2.

Pinout

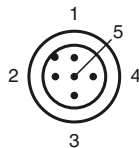

Wire colors in accordance with EN 60947-5-2

1	BN	(brown)
2	WH	(white)
3	BU	(blue)
4	BK	(black)
5	GY	(gray)

Accessories

MHW 11
Mounting brackets for sensors

M18K-VE

Additional Information

Output characteristic

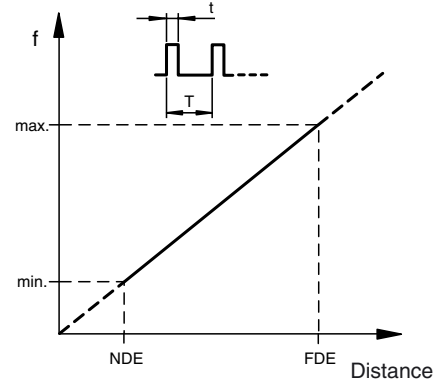

Rise-/fall time of output signal

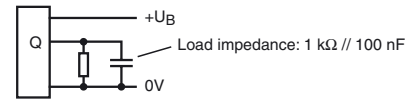
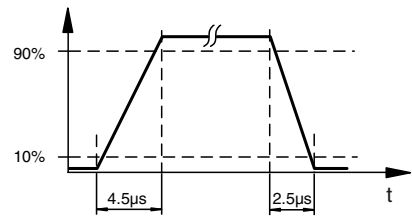

Parameter assignment of the signal output

The ultrasonic sensor is equipped with a signal output that represents the distance determined to the object in the form of a frequency proportional to the distance of the object. The current path characteristic of this output signal follows a zero-point straight line, i.e. The extrapolated output frequency for the object distance 0 (which is not usable in practical terms) also corresponds to 0. As the object distance increases, the output frequency also increases.

The object distance can be calculated according to:

$$\text{Object distance [mm]} = \text{output frequency [Hz]} / \text{gain [Hz/mm]}$$

If no object is detected, the level 1 is permanently present on the output.

The frequency of the output channel is adjusted by the gain of the output characteristic line.

Wiring arrangement of the parameterisation input	Gain of the output characteristic line
-U _B	2 Hz/mm
Not used	1 Hz/mm
+U _B	4 Hz/mm

The sensor checks the parameterisation input when the operating voltage is switched on. A change in the wiring of the parameterisation input during ongoing operation has no effect on the signal output.

LED display

The sensor is equipped with 2 LEDs. Their meaning is as follows:

LED green: Operating voltage applied

LED red: No object detected

Synchronisation

The sensor features a synchronisation input for the suppression of mutual interference. If this input is not used, the sensor will operate using an internally generated clock rate. The synchronisation of multiple sensors can be implemented as follows:

External synchronisation

The sensor can be synchronised by the external application of a square wave voltage. A synchronisation pulse at the synchronisation input starts a measuring cycle. The pulse must have a duration greater than 100 µs. The measuring cycle starts with the falling edge of a synchronisation pulse. A low level > 1 s or an open synchronisation input results in normal operation of the sensor. A high level at the synchronisation input disables the sensor.

Two operating modes are available

- 1) Multiple sensors can be controlled by the same synchronisation signal. The sensors work on the same clock rate.
- 2) The synchronisation pulses are sent cyclically to only one sensor at a time. The sensors operate in multiplex mode.

Internal synchronisation

The synchronisation connections of up to 5 sensors capable of internal synchronisation are connected to one another. When power is applied, these sensors operate in multiplex mode. The response delay increases according to the number of sensors to be synchronised.

Note

If the option for synchronisation is not used, the synchronisation input should be connected with ground (0 V) or the sensor should be operated with a V1 cable connector (4-pin).

Installation conditions

If the sensor is installed at places, where the environment temperature can fall below 0 °C, for the sensors fixation, one of the mounting flanges BF18, BF18-F or BF 5-30 must be used.

In case of direct mounting of the sensor in a through hole using the steel nuts, it has to be fixed at the middle of the housing thread. If a fixation at the front end of the threaded housing is required, plastic nuts with centering ring (accessories) must be used.

Release date: 2015-03-31 16:09 Date of issue: 2015-03-31 120318_eng.xml