



Coupling

9460 10*10

- Backlash-free, angle synchronous rotation transmission
- Optimal misalignment compensation
- Very high torsion spring stiffness
- Small reset forces
- Vibration-isolating
- Bellows and screws made of stainless steel

Stainless steel bellows coupling

Dimensions

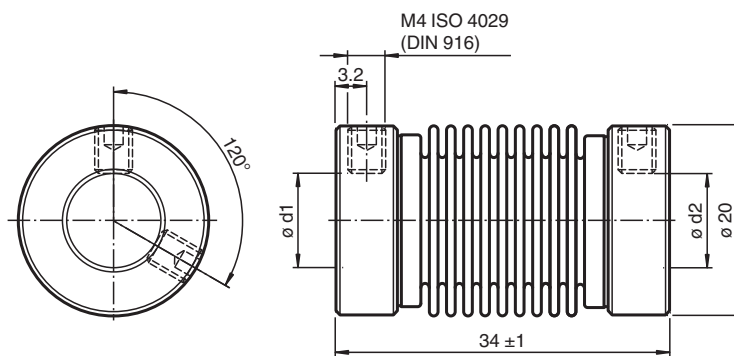

Technical Data

Ambient conditions	
Operating temperature	-30 ... 120 °C (-22 ... 248 °F)
Mechanical specifications	
Shaft diameter	d1 = 10 mm , d2 = 10 mm
Material	Stainless steel 1.4305 / AISI 303
Mass	30.1 g
Rotational speed	max. 10000 min
Max. torque	0.8 Nm
Radial offset	max. ± 0.3 mm
Axial offset	max. ± 0.5 mm
Angle error	max. ± 4 °
Torsion spring stiffness	140 Nm / rad
Radial spring stiffness	10 N / mm
Moment of inertia	18.81 kg m ² x 10 ⁻⁷
Mounting	clamp screws , M4 DIN 916
Tightening torque of clamping screws	max. 0.15 Nm

Release date: 2022-12-07 Date of issue: 2022-12-12 Filename: 121380_eng.pdf

Refer to "General Notes Relating to Pepperl+Fuchs Product Information".

Pepperl+Fuchs Group
www.pepperl-fuchs.com

USA: +1 330 486 0001
fa-info@us.pepperl-fuchs.com

Germany: +49 621 776 1111
fa-info@de.pepperl-fuchs.com

Singapore: +65 6779 9091
fa-info@sg.pepperl-fuchs.com

pf PEPPERL+FUCHS