

Cable connector

V1S-W-10M-PVC

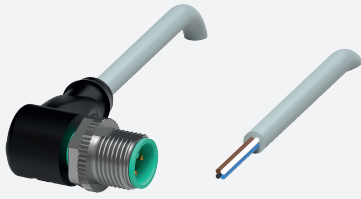

- Degree of protection IP68 / IP69
- Specific design protects against loosening and inaccurate installation

Male cordset single-ended M12 angled A-coded, 4-pin, PVC cable grey



Dimensions

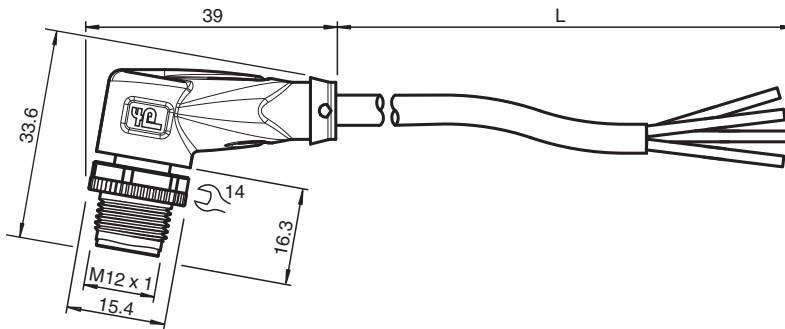

Technical Data

General specifications			
Connector 1			
Connection		plug	
Construction type		M12	
Style		angled	
Locking		screw connection	
Number of pins		4	
Coding		A-coded	
Connector 2			
Connection		cable end	
Electrical specifications			
Operating voltage	U_B	max. 250 V AC/DC	
Operating current	I_B	max. 4 A	
Conformity			
Degree of protection		EN 60529	
Plug connection		connector M12 x 1 : IEC 61076-2-101	
Flammability		IEC 60332-2-2	
Ambient conditions			
Ambient temperature			
Plug connector		-40 ... 90 °C (-40 ... 194 °F)	
Cable, fixed		-25 ... 70 °C (-13 ... 158 °F)	

Release date: 2023-08-10 Date of issue: 2023-08-10 Filename: 126971_eng.pdf

Refer to "General Notes Relating to Pepperl+Fuchs Product Information".

Pepperl+Fuchs Group
www.pepperl-fuchs.com

USA: +1 330 486 0001
fa-info@us.pepperl-fuchs.com

Germany: +49 621 776 1111
fa-info@de.pepperl-fuchs.com

Singapore: +65 6779 9091
fa-info@sg.pepperl-fuchs.com

PEPPERL+FUCHS

Technical Data

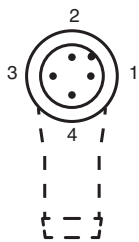

Cable, flexing	-5 ... 70 °C (23 ... 158 °F)	
Pollution degree	3	
Mechanical specifications		
Plug connector		
Tightening torque	0.6 Nm	
Loosening protection	available	
Tool installation	straight knurling and hexagon nut SW = 14 mm	
Mating cycles	min. 100	
Degree of protection	IP68 / IP69	
Cable		
Sheath diameter	4.8 mm	
Bending radius	> 10 x cable diameter, moving	
Sheath stripping force	max. 80 N / 300 mm	
Sheath color	grey (similar to RAL 7001)	
Number of cores	4	
Core cross section	0.34 mm ²	
Cores color	Core 1: brown Core 2: white Core 3: blue Core 4: black	
Core construction	19 x 0.15 mm Ø	
Length	L	10 m
Cable code	Li Y YM 4 x 0,34	
Material		
Plug connector		
Screw connection	Zinc diecast, nickel-plated	
Body	TPU, black	
Contact surface	gold plated (Au)	
Flammability	V-2	
Cable		
Sheathing	PVC	
Core insulation	PVC	
Flammability	flame-resistant	

Connection







1	BN
2	WH
3	BU
4	BK

Accessories

	MH V1-SCREWDRIVER	Torque screwdriver (0.6 Nm)
	MH V1-BIT M12	plug-in cap M12
	V1/V3-LABELHOLDER	Label holder

Accessories

	V1/V3-LABEL	Label plate
	MH V1-Holder	Modular universal holder for M12 connectors
	V1-CLIP	Unlocking protector for M12 connector
	V1-MARKING-RING-COLOR	Marking rings for M12 connectors, various colors