



Model Number

UB300-18GM40-E5-V1-Y133571

Single head system

Features

- Short design, 40 mm
- Function indicators visible from all directions
- Switch output
- 5 different output functions can be set
- Program input
- Temperature compensation

Diagrams

Characteristic response curve

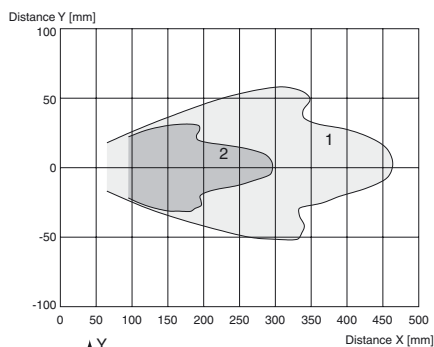

Curve 1: flat surface 100 mm x 100 mm
Curve 2: round bar, Ø 25 mm

133571_eng.xml Release date: 2013-06-24 12:40 Date of issue: 2013-07-31

Technical data

General specifications

Sensing range	30 ... 150 mm
Adjustment range	50 ... 150 mm
Unusable area	0 ... 30 mm
Standard target plate	100 mm x 100 mm
Transducer frequency	approx. 390 kHz
Response delay	approx. 4.5 ms

Indicators/operating means

LED yellow	indication of the switching state flashing: program function object detected
LED red	solid red: Error red, flashing: program function, object not detected

Electrical specifications

Operating voltage U_B	10 ... 30 V DC , ripple 10 % _{SS}
No-load supply current I_0	≤ 20 mA

Input

Input type	1 program input operating distance 1: $-U_B$... +1 V, operating distance 2: +6 V ... $+U_B$ input impedance: > 4,7 kΩ program pulse: ≥ 1 s
------------	---

Output

Output type	1 switch output E5, PNP NO/NC, programmable
Rated operating current I_e	200 mA , short-circuit/overload protected
Default setting	Switch point A1: 50 mm Switch point A2: 150 mm
Voltage drop U_d	≤ 3 V
Repeat accuracy	≤ 1 %
Switching frequency f	≤ 83 Hz
Range hysteresis H	1 % of the set operating distance
Temperature influence	± 1.5 % of full-scale value

Standard conformity

Standards	EN 60947-5-2
-----------	--------------

Ambient conditions

Ambient temperature	-25 ... 70 °C (-13 ... 158 °F)
Storage temperature	-40 ... 85 °C (-40 ... 185 °F)

Mechanical specifications

Connection type	Connector M12 x 1 , 4-pin
Protection degree	IP67
Connection	V1 connector (M12 x 1), 4-pin
Material	
Housing	brass, nickel-plated
Transducer	epoxy resin/hollow glass sphere mixture; foam polyurethane, cover PBT
Mass	25 g

Dimensions

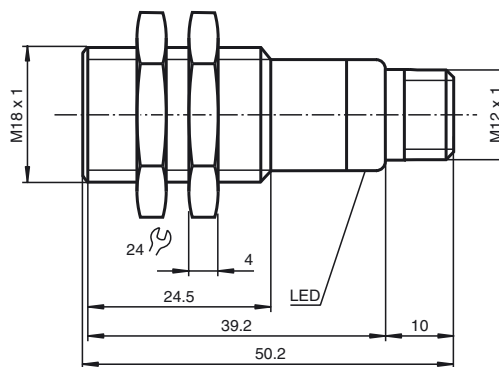

Electrical Connection

Standard symbol/Connections:
(version E5, pnp)

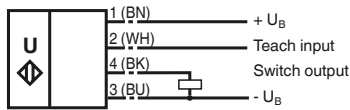

Core colours in accordance with EN 60947-5-2.

Pinout

Connector V1



Accessories

UB-PROG2

Programming unit

OMH-04

Mounting aid for round steel \varnothing 12 mm or sheet 1.5 mm ... 3 mm

BF 18

Mounting flange, 18 mm

BF 18-F

Mounting flange with dead stop, 18 mm

BF 5-30

Universal mounting bracket for cylindrical sensors with a diameter of 5 ... 30 mm

V1-G-2M-PVC

Female cordset, M12, 4-pin, PVC cable

V1-W-2M-PUR

Female cordset, M12, 4-pin, PUR cable

Adjusting the switching points

The ultrasonic sensor features a switch output with two teachable switching points. These are set by applying the supply voltage $-U_B$ or $+U_B$ to the TEACH-IN input. The supply voltage must be applied to the TEACH-IN input for at least 1 s. LEDs indicate whether the sensor has recognised the target during the TEACH-IN procedure. Switching point A1 is taught with $-U_B$, A2 with $+U_B$.

Five different output functions can be set

1. Window mode, normally-open function
2. Window mode, normally-closed function
3. one switching point, normally-open function
4. one switching point, normally-closed function
5. Detection of object presence

TEACH-IN window mode, normally-open function

- Set target to near switching point
- TEACH-IN switching point A1 with $-U_B$
- Set target to far switching point
- TEACH-IN switching point A2 with $+U_B$

TEACH-IN window mode, normally-closed function

- Set target to near switching point
- TEACH-IN switching point A2 with $+U_B$
- Set target to far switching point
- TEACH-IN switching point A1 with $-U_B$

TEACH-IN switching point, normally-open function

- Set target to near switching point
- TEACH-IN switching point A2 with $+U_B$
- Cover sensor with hand or remove all objects from sensing range
- TEACH-IN switching point A1 with $-U_B$

TEACH-IN switching point, normally-closed function

Additional Information

Programmable output modes

1. Window mode, normally open mode
A1 < A2:
2. Window mode, normally closed mode
A2 < A1:
3. One switch point, normally open mode
A1 -> ∞:
4. One switch point, normally closed mode
A2 -> ∞:
5. A1 -> ∞, A2 -> ∞: Object presence detection mode
Object detected: Switch output closed
No object detected: Switch output open

- Set target to near switching point
- TEACH-IN switching point A1 with $-U_B$
- Cover sensor with hand or remove all objects from sensing range
- TEACH-IN switching point A2 with $+U_B$

TEACH-IN detection of objects presence

- Cover sensor with hand or remove all objects from sensing range
- TEACH-IN switching point A1 with $-U_B$
- TEACH-IN switching point A2 with $+U_B$

LED Displays

Displays in dependence on operating mode	Red LED	Yellow LED
TEACH-IN switching point:		
Object detected	off	flashes
No object detected	flashes	off
Object uncertain (TEACH-IN invalid)	On	off
Normal operation	off	Switching state
Fault	on	Previous state

Installation conditions

If the sensor is installed at places, where the environment temperature can fall below 0 °C, for the sensors fixation, one of the mounting flanges BF18, BF18-F or BF 5-30 must be used.

In case of direct mounting of the sensor in a through hole using the steel nuts, it has to be fixed at the middle of the housing thread. If a fixation at the front end of the threaded housing is required, plastic nuts with centering ring (accessories) must be used.

Release date: 2013-06-24 12:40 Date of issue: 2013-07-31 133571_eng.xml