

# Switch Amplifier

## KFD2-SOT2-Ex1.LB

- 1-channel isolated barrier
- 24 V DC supply (Power Rail)
- Dry contact or NAMUR inputs
- Passive transistor output, non-polarized
- Passive fault output, non-polarized
- Line fault detection (LFD)
- Reversible mode of operation
- Up to SIL 2 acc. to IEC/EN 61508



### Function

This isolated barrier is used for intrinsic safety applications. It transfers digital signals (NAMUR sensors/mechanical contacts) from a hazardous area to a safe area. The proximity sensor or switch controls two passive transistors for the safe area load. The normal output state can be reversed using switch S1. Switch S2 allows output II to be switched between a signal output or an error message output. Switch S3 enables or disables line fault detection of the field circuit. During an error condition, the transistors revert to their de-energized state and LEDs indicate the fault according to NAMUR NE44. A unique collective error messaging feature is available when used with the Power Rail system.

### Connection

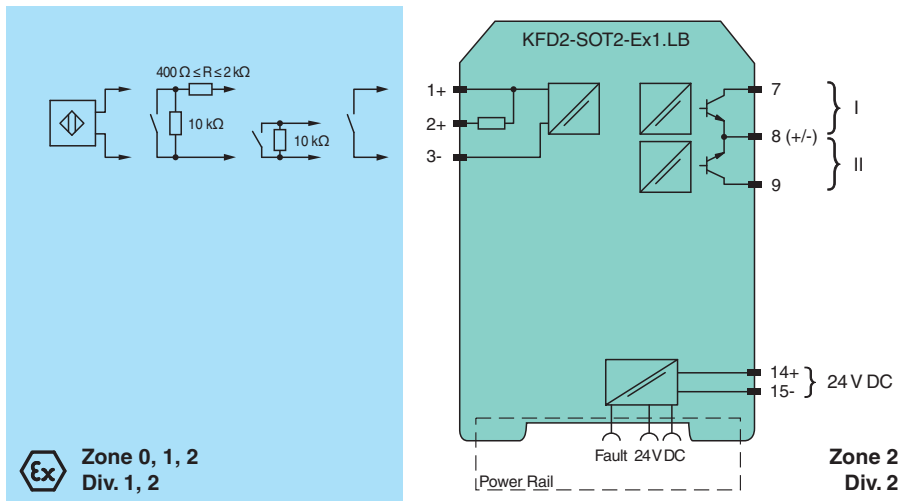

### Technical Data

<b>General specifications</b>	
Signal type	Digital Input
<b>Functional safety related parameters</b>	
Safety Integrity Level (SIL)	SIL 2
<b>Supply</b>	
Connection	Power Rail or terminals 14+, 15-
Rated voltage	$U_r$ 20 ... 30 V DC
Ripple	≤ 10 %
Rated current	$I_r$ ≤ 50 mA
<b>Input</b>	

Release date: 2022-01-10 Date of issue: 2022-01-10 Filename: 181002\_eng.pdf

Refer to "General Notes Relating to Pepperl+Fuchs Product Information".

Pepperl+Fuchs Group  
www.pepperl-fuchs.com

USA: +1 330 486 0002  
pa-info@us.pepperl-fuchs.com

Germany: +49 621 776 2222  
pa-info@de.pepperl-fuchs.com

Singapore: +65 6779 9091  
pa-info@sg.pepperl-fuchs.com



## Technical Data

Connection side		field side
Connection		terminals 1+, 2+, 3-
Rated values		acc. to EN 60947-5-6 (NAMUR), see manual for electrical data
Open circuit voltage/short-circuit current		approx. 8 V DC / approx. 8 mA
Switching point/switching hysteresis		1.2 ... 2.1 mA / approx. 0.2 mA
Line fault detection		breakage $I \leq 0.1$ mA , short-circuit $I > 6$ mA
<b>Output</b>		
Connection side		control side
Connection		output I: terminals 7, 8 ; output II: terminals 8, 9
Switching voltage		max. 30 V
Switching current		max. 100 mA , short-circuit protected
Signal level		1-signal: switching voltage - 2.5 V max. at 10 mA switching current or 3 V max. at 100 mA switching current 0-signal: switched off (off-state current $\leq 10$ $\mu$ A)
Output I		signal, passive electronic output
Output II		signal or error message; passive transistor output
Collective error message		Power Rail
<b>Transfer characteristics</b>		
Switching frequency		$\leq 5$ kHz
<b>Galvanic isolation</b>		
Input/Output		reinforced insulation acc. to IEC 62103, rated insulation voltage 300 V <sub>rms</sub>
Input/power supply		reinforced insulation acc. to IEC 62103, rated insulation voltage 300 V <sub>rms</sub>
Output/power supply		basic insulation according to IEC 62103, rated insulation voltage 50 V <sub>eff</sub>
Output/Output		not available
<b>Indicators/settings</b>		
Display elements		LEDs
Control elements		DIP switch
Configuration		via DIP switches
Labeling		space for labeling at the front
<b>Directive conformity</b>		
Electromagnetic compatibility		
Directive 2014/30/EU		EN 61326-1:2013 (industrial locations)
<b>Conformity</b>		
Galvanic isolation		IEC 62103:2003
Electromagnetic compatibility		NE 21:2004
Degree of protection		IEC 60529:2001
Input		EN 60947-5-6:2000
<b>Ambient conditions</b>		
Ambient temperature		-20 ... 60 °C (-4 ... 140 °F)
<b>Mechanical specifications</b>		
Degree of protection		IP20
Connection		screw terminals
Mass		approx. 150 g
Dimensions		20 x 119 x 115 mm (0.8 x 4.7 x 4.5 inch) (W x H x D) , housing type B2
Mounting		on 35 mm DIN mounting rail acc. to EN 60715:2001
<b>Data for application in connection with hazardous areas</b>		
EU-type examination certificate		PTB 00 ATEX 2035
Marking		⊕ II (1) G [Ex ia] IIC ⊕ II (1) D [Ex ia] IIIC
Input		Ex ia IIC, Ex ia IIIC
Voltage	U <sub>o</sub>	10.5 V
Current	I <sub>o</sub>	13 mA
Power	P <sub>o</sub>	34 mW (linear characteristic)
Supply		

Release date: 2022-01-10 Date of issue: 2022-01-10 Filename: 181002\_eng.pdf

Refer to "General Notes Relating to Pepperl+Fuchs Product Information".

Pepperl+Fuchs Group  
www.pepperl-fuchs.comUSA: +1 330 486 0002  
pa-info@us.pepperl-fuchs.comGermany: +49 621 776 2222  
pa-info@de.pepperl-fuchs.comSingapore: +65 6779 9091  
pa-info@sg.pepperl-fuchs.com

**PEPPERL+FUCHS**

**Technical Data**

Maximum safe voltage	U <sub>m</sub>	40 V DC (Attention! The rated voltage can be lower.)
Output		
Maximum safe voltage	U <sub>m</sub>	40 V DC (Attention! The rated voltage can be lower.)
EU-type examination certificate		DMT 01 ATEX E 133
Marking		Ⓢ I (M1) [Ex ia] I
Certificate		TÜV 99 ATEX 1499 X
Marking		Ⓢ II 3G Ex nA II T4
Galvanic isolation		
Input/Output		safe electrical isolation acc. to IEC/EN 60079-11, voltage peak value 375 V
Input/power supply		safe electrical isolation acc. to IEC/EN 60079-11, voltage peak value 375 V
Directive conformity		
Directive 2014/34/EU		EN 60079-0:2012+A11:2013 , EN 60079-11:2012 , EN 60079-15:2010 , EN 50303:2000
<b>International approvals</b>		
FM approval		
Control drawing		116-0035
CSA approval		
Control drawing		116-0047
IECEX approval		
IECEX certificate		IECEX PTB 05.0011
IECEX marking		[Ex ia] IIC , [Ex ia] I , [Ex ia] IIC
<b>General information</b>		
Supplementary information		Observe the certificates, declarations of conformity, instruction manuals, and manuals where applicable. For information see <a href="http://www.pepperl-fuchs.com">www.pepperl-fuchs.com</a> .

**Assembly**

**Front view**

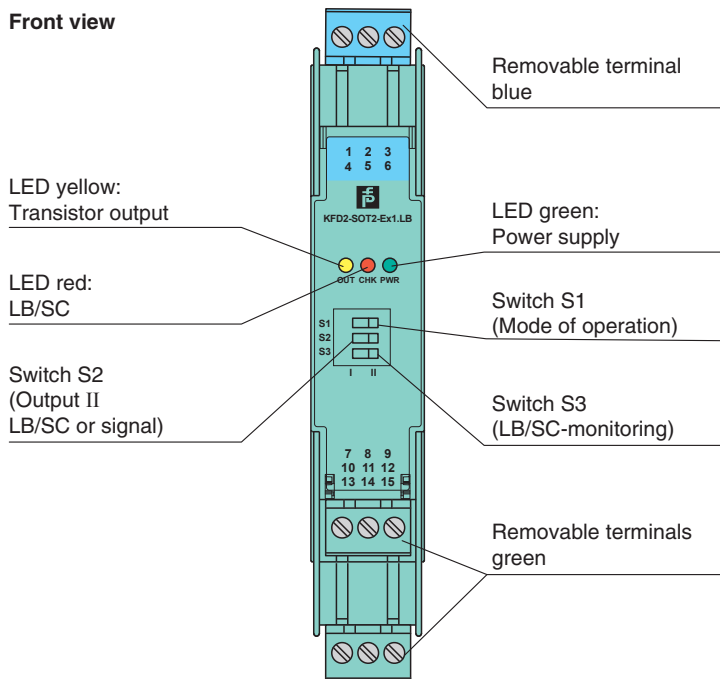





Release date: 2022-01-10 Date of issue: 2022-01-10 Filename: 181002\_eng.pdf

**Matching System Components**





	<b>KFD2-EB2</b>	Power Feed Module
-------------------------------------------------------------------------------------	-----------------	-------------------

Refer to "General Notes Relating to Pepperl+Fuchs Product Information".

## Matching System Components

	<b>UPR-03</b>	Universal Power Rail with end caps and cover, 3 conductors, length: 2 m
	<b>UPR-03-M</b>	Universal Power Rail with end caps and cover, 3 conductors, length: 1,6 m
	<b>UPR-03-S</b>	Universal Power Rail with end caps and cover, 3 conductors, length: 0.8 m
	<b>K-DUCT-BU</b>	Profile rail, wiring comb field side, blue
	<b>K-DUCT-BU-UPR-03</b>	Profile rail with UPR-03- * insert, 3 conductors, wiring comb field side, blue

## Accessories

	<b>F-NR3-Ex1</b>	NAMUR Resistor Network
	<b>KF-ST-5GN</b>	Terminal block for KF modules, 3-pin screw terminal, green
	<b>KF-ST-5BU</b>	Terminal block for KF modules, 3-pin screw terminal, blue
	<b>KF-CP</b>	Red coding pins, packaging unit: 20 x 6

**Configuration**

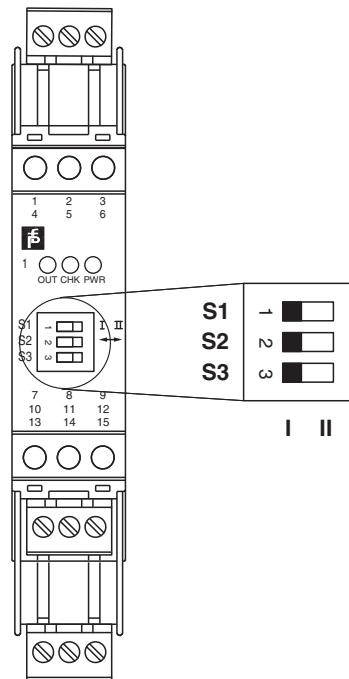

**Switch position**

S	Function		Position
1	Mode of operation output I active	with high input current	I
		with low input current	II
2	Assignment output II	Switching state like output I	I
		Fault indication output (passive if fault)	II
3	Line fault detection	ON	I
		OFF	II

**Operating states**

Control circuit	Input signal
Initiator high impedance/contact opened	low input current
Initiator low impedance/contact closed	high input current
Lead breakage, lead short circuit	Line fault

Factory setting: switch 1, 2 and 3 in position I

Release date: 2022-01-10 Date of issue: 2022-01-10 Filename: 181002\_eng.pdf