



## Background suppression sensor

ML4.2-8-H-60-RT/40b/95/110



- Precise background suppression
- Very small black-white difference
- Small, sharp light spot
- Highly visible LEDs for Power-On, switching status, short-circuit, and undervoltage
- Metal-reinforced fastening holes
- Tamper-proof version with no adjustments
- Push-pull output

Triangulation sensor with background suppression for complex applications, miniature design, 60 mm detection range, red light, light/dark on, push-pull output, M8 plug



### Function

The ML100 series is characterized by its miniature housing with integral, all-metal threaded bushings. All versions are equipped with a visible red transmitter LED. This greatly simplifies installation and commissioning. The switching states are easily visible from all directions thanks to the highly visible LEDs.

### Dimensions

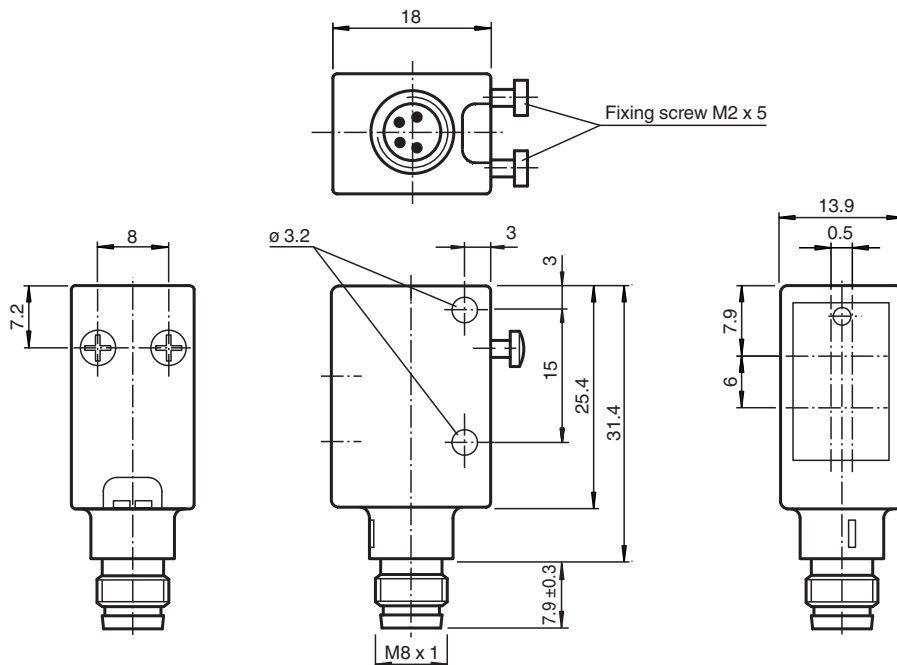

Release date: 2021-09-29 Date of issue: 2021-09-29 Filename: 183451\_eng.pdf

Refer to "General Notes Relating to Pepperl+Fuchs Product Information".

Pepperl+Fuchs Group  
www.pepperl-fuchs.com

USA: +1 330 486 0001  
fa-info@us.pepperl-fuchs.com

Germany: +49 621 776 1111  
fa-info@de.pepperl-fuchs.com

Singapore: +65 6779 9091  
fa-info@sg.pepperl-fuchs.com

**pf** PEPPERL+FUCHS

## Technical Data

General specifications		
Detection range		10 ... 60 mm
Detection range max.		10 ... 80 mm
Background suppression		starts from 80 mm
Light source		LED
Light type		modulated visible red light , 660 nm
Black-white difference (6 %/90 %)		approx. 10 mm
Diameter of the light spot		approx. 4 mm at 60 mm
Angle of divergence		approx. 5 °
Ambient light limit		
Continuous light		40000 Lux
Modulated light		5000 Lux
Functional safety related parameters		
MTTF <sub>d</sub>		1940 a
Mission Time (T <sub>M</sub> )		20 a
Diagnostic Coverage (DC)		0 %
Indicators/operating means		
Operation indicator		LED green, statically lit Power on , Undervoltage indicator: Green LED, pulsing (approx. 0.8 Hz) , short-circuit : LED green flashing (approx. 4 Hz)
Function indicator		LED yellow: lights when object is detected
Electrical specifications		
Operating voltage	U <sub>B</sub>	10 ... 30 V DC
Ripple		10 %
No-load supply current	I <sub>0</sub>	< 25 mA
Output		
Switching type		light/dark on electrically switchable
Signal output		Push-pull output, short-circuit protected, reverse polarity protected
Switching voltage		max. 30 V DC
Switching current		max. 100 mA
Voltage drop	U <sub>d</sub>	≤ 2.5 V DC
Switching frequency	f	1000 Hz
Response time		0.5 ms
Conformity		
Product standard		EN 60947-5-2
Compliance with standards and directives		
Standard conformity		
Shock and impact resistance		IEC / EN 60068. half-sine, 40 g in each X, Y and Z directions
Vibration resistance		IEC / EN 60068-2-6. Sinus. 10 -150 Hz, 5 g in each X, Y and Z directions
Approvals and certificates		
CE conformity		yes
UL approval		cULus Listed
CCC approval		CCC approval / marking not required for products rated ≤36 V
Ambient conditions		
Ambient temperature		-20 ... 60 °C (-4 ... 140 °F)
Storage temperature		-20 ... 75 °C (-4 ... 167 °F)
Mechanical specifications		
Housing width		13.9 mm
Housing height		31.4 mm
Housing depth		18 mm
Degree of protection		IP67 / IP69K
Connection		M8 x 1 connector, 4-pin
Material		
Housing		ABS

Release date: 2021-09-29 Date of issue: 2021-09-29 Filename: 183451\_eng.pdf

**Technical Data**

Optical face	glass pane
Mass	approx. 10 g

**Connection Assignment**

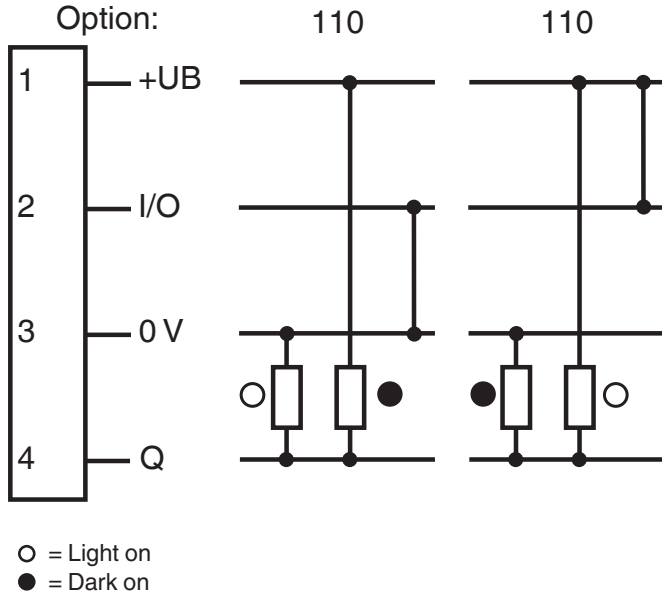

**Connection Assignment**



Wire colors in accordance with EN 60947-5-2

1	BN	(brown)
2	WH	(white)
3	BU	(blue)
4	BK	(black)

**Assembly**

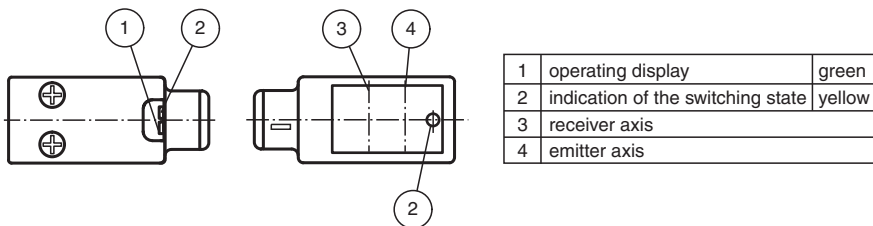





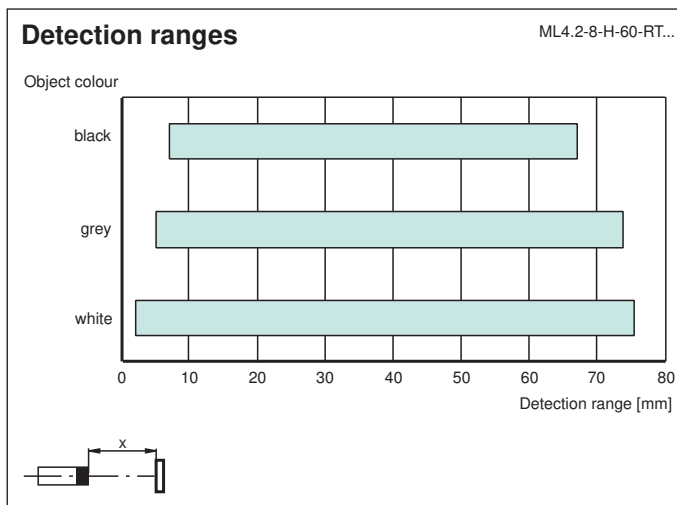
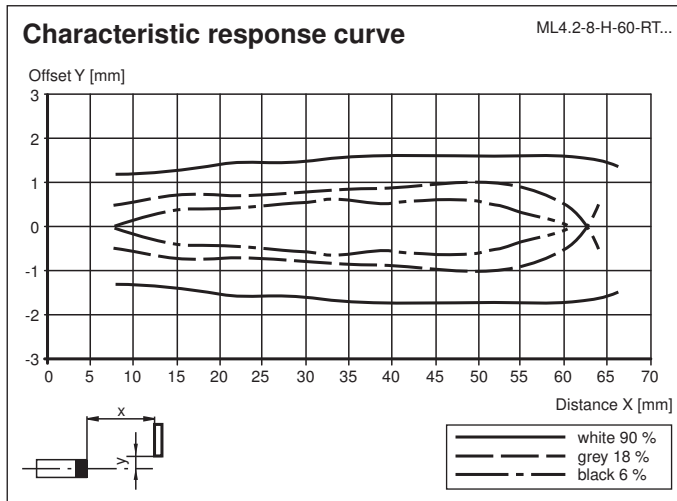

Release date: 2021-09-29 Date of issue: 2021-09-29 Filename: 183451\_eng.pdf

## Characteristic Curve



## Accessories

	<b>OMH-4.1</b>	Mounting Clamp
	<b>OMH-ML6</b>	Mounting bracket
	<b>OMH-ML6-U</b>	Mounting bracket
	<b>OMH-ML6-Z</b>	Mounting bracket
	<b>V31-GM-2M-PVC</b>	Female cordset single-ended M8 straight A-coded, 4-pin, PVC cable grey
	<b>V31-WM-2M-PVC</b>	Female cordset single-ended M8 angled A-coded, 4-pin, PVC cable grey

Release date: 2021-09-29 Date of issue: 2021-09-29 Filename: 183451\_eng.pdf